



45MG

Ultrasonic Thickness Gauge

User's Manual

DMTA-10022-01EN — Rev. F
September 2022

This instruction manual contains essential information on how to use this Evident product safely and effectively. Before using this product, thoroughly review this instruction manual. Use the product as instructed. Keep this instruction manual in a safe, accessible location.

EVIDENT SCIENTIFIC INC., 48 Woerd Avenue, Waltham, MA 02453, USA

Copyright © 2022 by Evident. All rights reserved. No part of this publication may be reproduced, translated, or distributed without the express written permission of Evident.

This document was prepared with particular attention to usage to ensure the accuracy of the information contained therein, and corresponds to the version of the product manufactured prior to the date appearing on the title page. There could, however, be some differences between the manual and the product if the product was modified thereafter.

The information contained in this document is subject to change without notice.

Part number: DMTA-10022-01EN

Rev. F

September 2022

Printed in the United States of America

All brands are trademarks or registered trademarks of their respective owners and third party entities.

Table of Contents

List of Abbreviations	9
Important Information – Please Read Before Use	11
Intended Use	11
Instruction Manual	11
Device Compatibility	12
Repair and Modification	12
Safety Symbols	12
Safety Signal Words	13
Note Signal Words	14
Safety	14
Warnings	14
Battery Precautions	15
Regulations for Shipping Products with Lithium-Ion Batteries	17
Equipment Disposal	17
BC (Battery Charger - California, USA Community)	17
CE (European Community)	18
UKCA (United Kingdom)	18
RCM (Australia)	18
WEEE Directive	18
China RoHS	19
Korea Communications Commission (KCC)	20
EMC Directive Compliance	20
FCC (USA) Compliance	20
ICES-001 (Canada) Compliance	22
Warranty Information	22
Technical Support	23

Introduction	25
1. Instrument Description	27
1.1 Product Description	27
1.2 Environmental Ratings	29
1.3 Instrument Hardware Components	29
1.4 Connectors	30
1.5 Keypad Functions	32
2. Powering the 45MG	37
2.1 Power Indicator	37
2.2 Battery Power	38
2.2.1 Battery Operating Time	38
2.2.2 Battery Level and Storage	39
2.2.3 Replacing the Batteries	39
3. Software User Interface Elements	43
3.1 Measurement Screen	43
3.2 Menus and Submenus	47
3.3 Parameter Screens	48
3.4 Selecting the Text Edit Mode	49
3.4.1 Editing Text Parameters Using the Virtual Keyboard	49
3.4.2 Editing Text Parameters Using the Traditional Method	51
4. Initial Setup	53
4.1 Setting the User Interface Language and Other System Options	53
4.2 Selecting the Measurement Units	54
4.3 Setting the Clock	54
4.4 Changing Display Settings	55
4.4.1 Color Schemes	57
4.4.2 Display Brightness	58
4.5 Adjusting the Measurement Update Rate	58
4.6 Changing the Thickness Resolution	60
5. Basic Operation	61
5.1 Setting Up the Transducer	61
5.2 Calibration	64
5.2.1 Calibrating the Instrument	65
5.2.2 Test Blocks	68
5.2.3 Transducer Zero Compensation	68
5.2.4 Material Sound Velocity and the Zero Calibrations	69

5.2.5	Entering a Known Material Sound Velocity	70
5.2.6	Locked Calibrations	70
5.2.7	Factors Affecting Performance and Accuracy	71
5.3	Measuring Thicknesses	73
5.4	Saving Data	75
6.	Software Options	77
6.1	Activating Software Options	78
6.2	Echo Detection Modes with Dual Element Transducers	80
6.2.1	Blanking Adjustments in Manual Echo-to-Echo Detection Mode	83
6.2.2	Dual Element Transducer Selection in Echo-to-Echo Modes	84
6.3	Measurements with Optional THRU-COAT, D7906, and D7908 Transducers	86
6.3.1	Enabling the THRU-COAT Function	86
6.3.2	Performing a THRU-COAT Calibration	87
6.4	Waveform Software Option	88
6.4.1	Waveform Rectification	90
6.4.2	Waveform Trace	92
6.4.3	Range of the Waveform Display	92
6.4.3.1	Selecting the Range Value	93
6.4.3.2	Adjusting the Delay Value	94
6.4.3.3	Activating the Zoom Function (Available Only with the Waveform Option)	94
6.5	Single Element and High Resolution Option	96
6.5.1	Recalling Single Element Transducer Setups	96
6.5.2	Creating Custom Single Element Transducer Setups	97
6.5.3	High-Resolution Thickness	97
6.6	High-Penetration Software Option	97
6.7	Datalogger Option	98
6.7.1	Datalogger	98
6.7.2	Creating a Data File	101
6.7.2.1	Data File Types	103
6.7.2.2	Incremental Data File Type	103
6.7.2.3	Sequential Data File Type	106
6.7.2.4	Sequential with Custom Point Data File Type	107
6.7.2.5	2-D Grid Data File Type	108
6.7.2.6	Boiler Data File Type	112
6.7.3	File Data Modes	114
6.7.4	Performing File Operations	115
6.7.4.1	Opening a File	116
6.7.4.2	Reviewing a File	117
6.7.4.3	Copying a File	117

6.7.4.4	Editing a File	118
6.7.4.5	Deleting a File or Its Contents	121
6.7.4.6	Deleting a Range of IDs	122
6.7.4.7	Deleting All Data Files	123
6.7.4.8	Viewing the Memory Status	124
6.7.5	Setting the ID Overwrite Protection	125
6.7.6	ID Review Screen	125
6.7.6.1	Reviewing Stored Data and Changing the Active ID	127
6.7.6.2	Editing the ID	127
6.7.6.3	Erasing Data in the Active File	129
6.7.7	Generating Reports	130
7.	Using Special Functions	137
7.1	Activating and Configuring a Differential Mode	137
7.2	Using the Minimum, Maximum, or Min/Max Thickness Mode	139
7.3	Preventing False Minimum/Maximum Thickness Readings	141
7.4	Using Alarms	141
7.5	Locking the Instrument	146
7.6	Freezing the Measurement or Optional Waveform	148
8.	Configuring the Instrument	149
8.1	Configuring Measurement Parameters	149
8.2	Configuring System Parameters	152
8.3	Configuring Communications	153
9.	Using Advanced Gaging Features	157
9.1	Adjusting the Gain with Dual Element Transducers	157
9.2	Adjusting the Extended Blank with Dual Element Transducers	159
9.3	B-Scan	161
9.3.1	Using the B-Scan	164
9.3.2	Using the B-Scan Alarm Mode	165
9.3.3	Saving B-Scans or Thickness Readings (Optional Datalogger)	165
9.4	DB Grid	167
9.4.1	Activating and Configuring the DB Grid	167
9.4.2	Changing the Highlighted Cell in the DB Grid	169
9.4.3	Saving Thickness Readings in the DB Grid	170
9.4.4	Viewing an Inserted or an Appended Cell in the DB Grid	171
10.	Custom Setups for Single Element Transducers	173
10.1	Creating a Custom Setup for a Single Element Transducer	173

10.2	Quickly Adjusting Waveform Parameters For Single Element Transducers	176
10.3	Detection Modes	177
10.4	First Peak	179
10.5	Pulser Power	180
10.6	Time-Dependent Gain Curve	181
10.6.1	Maximum Gain	182
10.6.2	Initial Gain	183
10.6.3	TDG Slope	183
10.7	Main Bang Blank	183
10.8	Echo Window	185
10.8.1	Detection of Echo 1 and Echo 2	187
10.8.2	Interface Blank	188
10.8.3	Mode 3 Echo Blank	190
10.9	Saving Setup Parameters	191
10.10	Quickly Recalling a Custom Setup for Single Element Transducers	192
11.	Managing Communications and Data Transfer	195
11.1	GaugeView	195
11.2	Setting Up USB Communication	195
11.3	Exchanging Data with a Remote Device	197
11.3.1	Exporting a File to the Memory Card (Datalogger Option Only)	197
11.3.2	Importing Survey Files from the External Memory Card	198
11.3.3	Receiving Files from a Computer	200
11.4	Capturing Screen Images	200
11.4.1	Sending a Screen Capture to GaugeView	201
11.4.2	Sending a Screen Capture to the External microSD Card	202
11.5	Resetting the Communication Parameters	203
12.	Maintaining and Troubleshooting the 45MG	205
12.1	Routine Gauge Handling	205
12.2	Cleaning the Instrument	206
12.3	Maintaining Transducers	206
12.4	Using Instrument Resets	206
12.5	Performing Hardware Diagnostic Tests	209
12.6	Performing the Software Diagnostic Test	211
12.7	Viewing the Instrument Status	212
12.8	Understanding Error Messages	213
12.9	Resolving Battery Problems	213
12.10	Resolving Measurement Problems	214

Appendix A: Technical Specifications	215
Appendix B: Sound Velocities	225
Appendix C: Accessories and Replacement Parts	227
List of Figures	231
List of Tables	235

List of Abbreviations

2-D	two-dimensional
AEtoE	automatic Echo-to-Echo
AGC	automatic gain control
CSV	comma separated variables
DB	database
DIAG	diagnostic
DIFF	differential
EFUP	environment-friendly use period
ESS	electronic stress screening
EXT	extended
FRP	fiber-reinforced polymer
GB	gigabytes
GRN	green
HDPE	high-density polyethylene
HI	high
ID	identification
LDPE	low-density polyethylene
LOS	loss-of-signal
MAX	maximum
MB	main bang
MEtoE	manual Echo-to-Echo
MIL	military
MIN	minimum
NiMH	nickel-metal hydride
PDF	portable document format
PRF	pulse repetition frequency
PVC	polyvinyl chloride
SE	single element
STD	standard
SW	software
TDG	time-dependent gain
TFT	thin-film transistor (liquid crystal display technology)
TOF	time-of-flight

USB universal serial bus
YEL yellow

Important Information — Please Read Before Use

Intended Use

The 45MG is designed to perform nondestructive inspections on industrial and commercial materials.



WARNING

Do not use the 45MG for any purpose other than its intended use. It must never be used to inspect or examine human or animal body parts.

Instruction Manual

This instruction manual contains essential information on how to use this product safely and effectively. Before using this product, thoroughly review this instruction manual. Use the product as instructed. Keep this instruction manual in a safe, accessible location.

IMPORTANT

Some of the details of components illustrated in this manual may differ from the components installed on your device. However, the operating principles remain the same.

Device Compatibility

Only use this device with the approved ancillary equipment provided by Evident. Equipment provided by Evident and approved for use with this device is described later in this manual.



CAUTION

Always use equipment and accessories that meet Evident specifications. Using incompatible equipment could cause equipment malfunction and/or damage, or human injury.

Repair and Modification

This device does not contain any user-serviceable parts. Opening the device might void the warranty.



CAUTION

In order to prevent human injury and/or equipment damage, do not disassemble, modify, or attempt to repair the device.

Safety Symbols

The following safety symbols might appear on the device and in the instruction manual:



General warning symbol

This symbol is used to alert the user to potential hazards. All safety messages that follow this symbol shall be obeyed to avoid possible harm or material damage.



High voltage warning symbol

This symbol is used to alert the user to potential electric shock hazards greater than 1000 volts. All safety messages that follow this symbol shall be obeyed to avoid possible harm.

Safety Signal Words

The following safety symbols might appear in the documentation of the device:



DANGER

The DANGER signal word indicates an imminently hazardous situation. It calls attention to a procedure, practice, or the like, which, if not correctly performed or adhered to, will result in death or serious personal injury. Do not proceed beyond a DANGER signal word until the indicated conditions are fully understood and met.



WARNING

The WARNING signal word indicates a potentially hazardous situation. It calls attention to a procedure, practice, or the like, which, if not correctly performed or adhered to, could result in death or serious personal injury. Do not proceed beyond a WARNING signal word until the indicated conditions are fully understood and met.



CAUTION

The CAUTION signal word indicates a potentially hazardous situation. It calls attention to an operating procedure, practice, or the like, which, if not correctly performed or adhered to, may result in minor or moderate personal injury, material damage, particularly to the product, destruction of part or all of the product, or loss of data. Do not proceed beyond a CAUTION signal word until the indicated conditions are fully understood and met.

Note Signal Words

The following note signal words could appear in the documentation of the device:

IMPORTANT

The IMPORTANT signal word calls attention to a note that provides important information, or information essential to the completion of a task.

NOTE

The NOTE signal word calls attention to an operating procedure, practice, or the like, which requires special attention. A note also denotes related parenthetical information that is useful, but not imperative.

TIP

The TIP signal word calls attention to a type of note that helps you apply the techniques and procedures described in the manual to your specific needs, or provides hints on how to effectively use the capabilities of the product.

Safety

Before turning on the device, verify that the correct safety precautions have been taken (see the following warnings). In addition, note the external markings on the device, which are described under “Safety Symbols.”

Warnings



WARNING

General Warnings

- Carefully read the instructions contained in this instruction manual prior to turning on the device.
- Keep this instruction manual in a safe place for further reference.

- Follow the installation and operation procedures.
- It is imperative to respect the safety warnings on the device and in this instruction manual.
- If the equipment is used in a manner not specified by the manufacturer, the protection provided by the equipment could be impaired.
- Do not install substitute parts or perform any unauthorized modification to the device.
- Service instructions, when applicable, are for trained service personnel. To avoid the risk of electric shock, do not perform any work on the device unless qualified to do so. For any problem or question regarding this device, contact Evident or an authorized Evident representative.
- Do not touch the connectors directly by hand. Otherwise, a malfunction or electric shock may result.
- Do not allow metallic or foreign objects to enter the device through connectors or any other openings. Otherwise, a malfunction or electric shock may result.

**WARNING****Electrical Warning**

The device must only be connected to a power source corresponding to the type indicated on the rating label.

**CAUTION**

If a non-approved power supply cord not dedicated to Evident products is used, Evident will not be able to ensure the electrical safety of the equipment.

Battery Precautions**CAUTION**

- Before disposing of a battery, check your local laws, rules, and regulations, and follow them accordingly.

- Transportation of lithium-ion batteries is regulated by the United Nations under the United Nations Recommendations on the Transport of Dangerous Goods. It is expected that governments, intergovernmental organizations, and other international organizations shall conform to the principles laid down in these regulations, thus contributing to worldwide harmonization in this field. These international organizations include the International Civil Aviation organization (ICAO), the International Air Transport Association (IATA), the International Maritime Organization (IMO), the US Department of Transportation (USDOT), Transport Canada (TC), and others. Please contact the transporter and confirm current regulations before transportation of lithium-ion batteries.
- For California (USA) only:
The device may contain a CR battery. The CR battery contains perchlorate material, and special handling may be required. Refer to <http://www.dtsc.ca.gov/hazardouswaste/perchlorate>.
- Do not open, crush, or perforate batteries; doing so could cause injury.
- Do not incinerate batteries. Keep batteries away from fire and other sources of extreme heat. Exposing batteries to extreme heat (over 80 °C) could result in an explosion or personal injury.
- Do not drop, hit, or otherwise abuse a battery, as doing so could expose the cell contents, which are corrosive and explosive.
- Do not short-circuit the battery terminals. A short circuit could cause injury and severe damage to a battery making it unusable.
- Do not expose a battery to moisture or rain; doing so could cause an electric shock.
- Only use an external charger approved by Evident to charge the batteries.
- Only use batteries supplied by Evident.
- Do not store batteries that have less than 40 % remaining charge. Recharge batteries to between 40 % and 80 % capacity before storing them.
- During storage, keep the battery charge between 40 % and 80 %.
- Do not leave batteries in the 45MG unit during device storage.

Regulations for Shipping Products with Lithium-Ion Batteries

IMPORTANT

When shipping a Li-ion battery or batteries, be sure to follow all local transportation regulations.



WARNING

Damaged batteries cannot be shipped through normal routes — DO NOT ship damaged batteries to Evident. Contact your local Evident representative or material disposal professionals.

Equipment Disposal

Before disposing of the 45MG, check your local laws, rules, and regulations, and follow them accordingly.

BC (Battery Charger - California, USA Community)



The BC marking indicates that this product has been tested and complies with the Appliance Efficiency Regulations as stated in the California Code of Regulations Title 20, Sections 1601 through 1608 for Battery Charger Systems. The internal battery charger within this device has been tested and certified pursuant to the California Energy Commission's (CEC) requirements; this device is listed on the online CEC's (T20) database.

CE (European Community)



This device complies with the requirements of directive 2014/30/EU concerning electromagnetic compatibility, directive 2014/35/EU concerning low voltage, and directive 2015/863 which amends 2011/65/EU concerning restriction of hazardous substances (RoHS). The CE marking is a declaration that this product conforms to all the applicable directives of the European Community.

UKCA (United Kingdom)



This device complies with the requirements of the Electromagnetic Compatibility Regulations 2016, the Electrical Equipment (Safety) Regulations 2016, and the Restriction of the Use of Certain Hazardous Substances in Electrical and Electronic Equipment Regulations 2012. The UKCA marking indicates compliance with the above regulations.

RCM (Australia)



The regulatory compliance mark (RCM) label indicates that the product complies with all applicable standards, and has been registered with the Australian Communications and Media Authority (ACMA) for placement on the Australian market.

WEEE Directive



In accordance with European Directive 2012/19/EU on Waste Electrical and Electronic Equipment (WEEE), this symbol indicates that the product must not be disposed of as unsorted municipal waste, but should be collected separately. Refer to your local Evident distributor for return and/or collection systems available in your country.



China RoHS

China RoHS is the term used by industry generally to describe legislation implemented by the Ministry of Information Industry (MII) in the People's Republic of China for the control of pollution by electronic information products (EIP).



The China RoHS mark indicates the product's Environment-Friendly Use Period (EFUP). The EFUP is defined as the number of years for which listed controlled substances will not leak or chemically deteriorate while in the product. The EFUP for the 45MG has been determined to be 15 years.

Note: The Environment-Friendly Use Period (EFUP) is not meant to be interpreted as the period assuring functionality and product performance.



电器电子产品有害
物质限制使用
标志

本标志是根据“电器电子产品有害物质限制使用管理办法”以及“电子电气产品有害物质限制使用标识要求”的规定，适用于在中国销售的电器电子产品上的电器电子产品有害物质使用限制标志。

（注意）电器电子产品有害物质限制使用标志内的数字为在正常的使用条件下有害物质等不泄漏的期限，不是保证产品功能性能的期间。

产品中有害物质的名称及含量

部件名称		有害物质					
		铅及其化合物 (Pb)	汞及其化合物 (Hg)	镉及其化合物 (Cd)	六价铬及其化合物 (Cr(VI))	多溴联苯 (PBB)	多溴二苯醚 (PBDE)
主体	机构部件	×	○	○	○	○	○
	光学部件	×	○	○	○	○	○
	电气部件	×	○	○	○	○	○

产品中有害物质的名称及含量

部件名称	有害物质					
	铅及其化合物 (Pb)	汞及其化合物 (Hg)	镉及其化合物 (Cd)	六价铬及其化合物 (Cr(VI))	多溴联苯 (PBB)	多溴二苯醚 (PBDE)
附件	×	○	○	○	○	○
本表格依据 SJ/T 11364 的规定编制。 ○：表示该有害物质在该部件所有均质材料中的含量均在 GB/T26572 规定的限量要求以下。 ×：表示该有害物质至少在该部件的某一均质材料中的含量超出 GB/T26572 规定的限量要求。						

Korea Communications Commission (KCC)



Seller and user shall be noticed that this equipment is suitable for electromagnetic equipment for office work (class A) and it can be used outside the home. This device complies with the EMC requirements of Korea.

The MSIP code for the device is the following: MSIP-REM-OYN-45MG.

이 기기는 업무용 환경에서 사용할 목적으로 적합성평가를 받은 기기로서 가정용 환경에서 사용하는 경우 전파간섭의 우려가 있습니다.

EMC Directive Compliance

This equipment generates and uses radio-frequency energy and, if not installed and used properly (that is, in strict accordance with the manufacturer's instructions), may cause interference. The 45MG has been tested and found to comply with the limits for an industrial device in accordance with the specifications of the EMC directive.

FCC (USA) Compliance

NOTE

This product has been tested and found to comply with the limits for a Class A digital device, pursuant to Part 15 of the FCC Rules. These limits are designed to provide reasonable protection against harmful interference when the product is operated in a commercial environment. This product generates, uses, and can radiate radio frequency energy, and if not installed and used in accordance with the instruction manual, might cause harmful interference to radio communications. Operation of this product in a residential area is likely to cause harmful interference, in which case you will be required to correct the interference at your own expense.

IMPORTANT

Changes or modifications not expressly approved by the party responsible for compliance could void the user's authority to operate the product.

FCC Supplier's Declaration of Conformity

Hereby declares that the product,

Product name: 45MG

Model: 45MG-MR/45MG-CW

Conforms to the following specifications:

FCC Part 15, Subpart B, Section 15.107 and Section 15.109.

Supplementary information:

This device complies with Part 15 of the FCC Rules. Operation is subject to the following two conditions:

- (1) This device may not cause harmful interference.
- (2) This device must accept any interference received, including interference that may cause undesired operation.

Responsible party name:

EVIDENT SCIENTIFIC INC.

Address:

48 Woerd Avenue, Waltham, MA 02453, USA

Phone number:

+1 781-419-3900

ICES-001 (Canada) Compliance

This Class A digital apparatus complies with Canadian ICES-001.

Cet appareil numérique de la classe A est conforme à la norme NMB-001 du Canada.

Warranty Information

Evident guarantees your Evident product to be free from defects in materials and workmanship for a specific period, and in accordance with conditions specified in the Terms and Conditions available at <https://www.olympus-ims.com/en/terms/>.

The Evident warranty only covers equipment that has been used in a proper manner, as described in this instruction manual, and that has not been subjected to excessive abuse, attempted unauthorized repair, or modification.

Inspect materials thoroughly on receipt for evidence of external or internal damage that might have occurred during shipment. Immediately notify the carrier making the delivery of any damage, because the carrier is normally liable for damage during shipment. Retain packing materials, waybills, and other shipping documentation needed in order to file a damage claim. After notifying the carrier, contact Evident for assistance with the damage claim and equipment replacement, if necessary.

This instruction manual explains the proper operation of your Evident product. The information contained herein is intended solely as a teaching aid, and shall not be used in any particular application without independent testing and/or verification by the operator or the supervisor. Such independent verification of procedures becomes increasingly important as the criticality of the application increases. For this reason, Evident makes no warranty, expressed or implied, that the techniques, examples, or procedures described herein are consistent with industry standards, nor that they meet the requirements of any particular application.

Evident reserves the right to modify any product without incurring the responsibility for modifying previously manufactured products.

Technical Support

Evident is firmly committed to providing the highest level of customer service and product support. If you experience any difficulties when using our product, or if it fails to operate as described in the documentation, first consult the user's manual, and then, if you are still in need of assistance, contact our After-Sales Service. To locate the nearest service center, visit the Service Centers page on the Evident Scientific Web site.

Introduction

This user's manual provides operating instruction for the 45MG ultrasonic thickness gauge. The information in this manual is organized to explain the technology, safety details, hardware, and software. Practical measurement examples help the user become familiar with the instrument's capabilities.

IMPORTANT

This manual describes how to use the 45MG instrument's advanced features, including the use of special transducers, management of custom transducer setups, software options, the datalogger, and communication with external devices.

The PDF file for this manual is included on the documentation CD (P/N: 45MG-MAN-CD [U8147024]) that is shipped with the 45MG.



Figure i-1 The 45MG instrument

1. Instrument Description

This chapter describes the main features and hardware components of the 45MG instrument.

1.1 Product Description

The 45MG by Evident is a handheld ultrasonic thickness gauge designed for a wide variety of thickness-measurement applications. With the 45MG, you only need access to one side of a part in order to obtain nondestructive measurements of the thickness of corroded, pitted, scaled, granular, and other difficult materials.

The 45MG displays a thickness readout and offers an optional A-scan view for waveform verification. The microprocessor of the 45MG continuously adjusts the receiver setup so that every measurement is optimized for reliability, range, sensitivity, and accuracy. An optional advanced internal datalogger can store up to 475000 thickness measurements and 20000 waveforms.

With the Single Element option, the 45MG operates with a full line of single element transducers. Operation with dual element transducers is a standard feature. Depending on the software options, the 45MG is capable of measuring material thicknesses between 0.08 mm and 635.0 mm (0.003 in. and 25.0 in.). The temperature range of measured materials may vary between $-20\text{ }^{\circ}\text{C}$ and $500\text{ }^{\circ}\text{C}$ ($-4\text{ }^{\circ}\text{F}$ and $932\text{ }^{\circ}\text{F}$), depending on the material characteristics, the transducer, and the measurement mode.

Basic features

- Measurement-related status flags and alarms
- Quarter VGA color transfective LED back-lite display

- Automatic probe recognition for the standard D79X and MTD705 series transducers
- Warning against calibration doubling (for dual element transducers)
- Calibration for unknown material sound velocity and/or transducer zero
- Fast scan mode with 20 readings per second
- Hold or blank thickness display during loss-of-signal (LOS) conditions
- Hold minimum and maximum functions
- Differential thickness display relative to the set point in absolute values or percentage ratios
- Selection of password-protected lockout functions
- Selectable resolution: low of 0.1 mm (0.01 in.), standard of 0.01 mm (0.001 in.), or high (optional) of 0.001 mm (0.0001 in.); [option not available for all transducers]

Optional features

- Single element transducers
- Echo-to-Echo and THRU-COAT measurements
- High Penetration software for low-frequency single element transducers
- A-scan or waveform display
 - Real-time A-scan waveform display for verification of critical measurements
 - Manual freeze mode with post processing
 - Manual zoom and range control of waveform display
 - Auto hold on loss of signal (LOS) and auto zoom (measured echo centering)
 - Extended blank
 - Blank after first received echo in Echo-to-Echo mode
 - Receiver gain readout
 - Ability to capture and display waveform associated with minimum thickness during scanned measurements
 - Display of stored and downloaded waveforms (Datalogger option only)
 - Manual gain adjustment in 1-dB steps
- Internal datalogger functions
 - Internal data storage and possibility to export data to a removable microSD memory card
 - Capacity to store 475000 fully-documented thickness readings or 20000 waveforms with thickness readings

- Database enhancements include 32-character file naming and 20-character ID naming
- Automatic ID number increments following a preset sequence, or manual ID numbering using the keypad
- Save reading/waveform to an ID number
- Ability to simultaneously display ID number and stored reference thickness while displaying active thickness and waveform
- Five file formats available
- Erase selected data or all stored data
- Standard USB directional communication

1.2 Environmental Ratings

The 45MG is a rugged and durable instrument that can be used in harsh environments. The 45MG was designed to meet the requirement of the IP67 rating (Ingress Protection rating).



CAUTION

Evident cannot guarantee any level of ingress protection rating once the instrument seals have been manipulated. You must use sound judgment, and take proper precautions before exposing the instrument to harsh environments.

To maintain the original level of ingress protection, you are responsible for the proper care of all routinely exposed membrane seals. Additionally, you are responsible for returning the instrument to an authorized Evident service center on an annual basis to ensure that the instrument seals are properly maintained.

1.3 Instrument Hardware Components

The 45MG front panel features a color display and a keypad. The instrument comes with a wrist strap. An optional protective rubber boot includes a dust flap seal for the USB communication connector, strap rings at the four corners, and a stand at the back of the instrument (see Figure 1-1 on page 30).



Figure 1-1 The 45MG hardware components – Front, top, and side views

1.4 Connectors

Figure 1-2 on page 30 illustrates the possible connections between the 45MG and external devices.

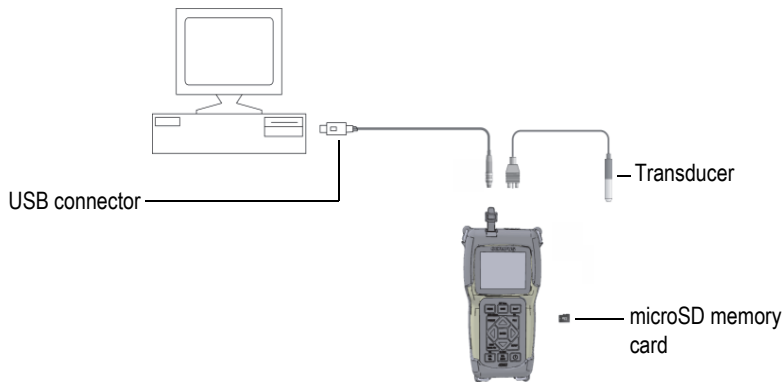

Figure 1-2 The 45MG connections

The USB and Transmit/Receive transducer connectors are located on the top of the 45MG (see Figure 1-3 on page 31).

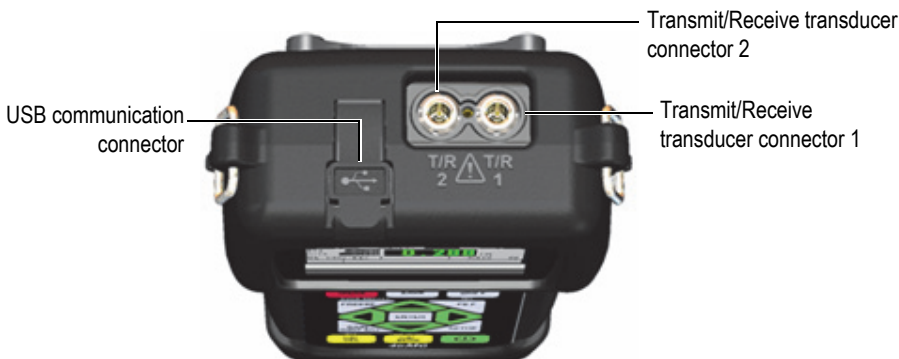

Figure 1-3 The top end connectors

The external microSD memory card slot is located behind the battery door (see Figure 1-4 on page 31).

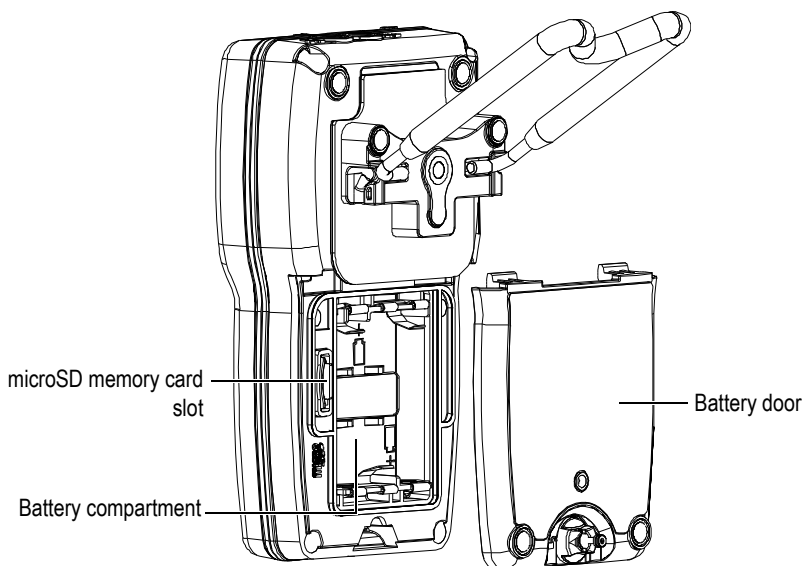

Figure 1-4 The microSD connector behind the battery door

1.5 Keypad Functions

The 45MG comes either with the English or the international keypad (see Figure 1-5 on page 32). The functions are the same for both keypads. On the international keypad, the text labels on many keys are replaced by pictograms. In this document, keypad keys are referred to using the English label in bold and within brackets (ex.: [MEAS]).

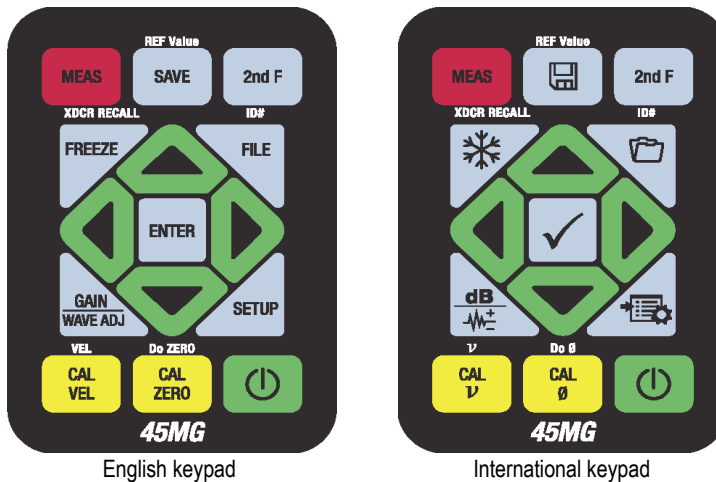

Figure 1-5 The 45MG keypads

Each key is labeled according to its primary function. The area immediately above certain keys contains a secondary key function that can be activated by first pressing [2nd F]. Throughout this document, references to a secondary function are written as follows: [2nd F], [Primary] (Secondary). For example, the instruction to activate the REF Value function is written as follows: “Press [2nd F], [SAVE] (REF Value)”.

The [▲], [▼], [◀], and [▶] keys, along with the [ENTER] key, are used to select menu items or screen parameters, and to change parameter values. Use the [MEAS] key at any time to return to the measurement screen. The yellow keys are related to calibration.

Table 1 on page 33 lists the key functions available on the 45MG keypad. Many functions are optional, and may not be available depending on which software options have been purchased.

Table 1 Keypad functions













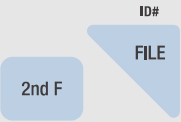





English	International	Functions
		Measurement — Completes the current operation and returns to the measurement screen.
		Identification number — Accesses several functions related to the ID numbers for the thickness-measurement location.
		File — Opens the file menu to access file commands (open, review, create, copy, edit, delete, send, import, export, memory, and report).
		Secondary function — Needs to be pressed prior to a key to activate the secondary function of the key.
		Save — Stores a measurement and optionally the corresponding waveform in the datalogger at the current ID number.
		Freeze — Causes the displayed screen or waveform to immediately hold until the key is pressed again.
		Gain — Initiates the adjustment of the gain value when using dual element transducers. Wave adjustment — Toggles the display of a selectable waveform parameter with an editable value.
		Enter — Selects a highlighted item, or accepts an entered value.
		Up arrow <ul style="list-style-type: none"> In a screen or a list, moves to the previous element. For some parameters, a numerical entry increases the value.

Table 1 Keypad functions (continued)















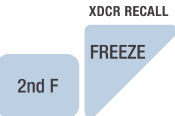
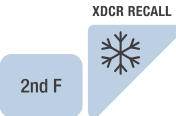

English	International	Functions
		<p>Down arrow</p> <ul style="list-style-type: none"> In a screen or a list, moves to the next element. For some parameters, a numerical entry decreases the value.
		<p>Left arrow</p> <ul style="list-style-type: none"> Selects the previous available value for the selected parameter. In text edit mode, moves the cursor one character position to the left.
		<p>Right arrow</p> <ul style="list-style-type: none"> Selects the next available value for the selected parameter. In text edit mode, moves the cursor one character position to the right.
		<p>Transducer recall — Recalls default or custom transducer (XDCR) setups.</p>
		<p>Reference value — For some functions (ex.: differential mode, or thickness for velocity mode), opens a screen allowing you to enter a reference value.</p>
		<p>Velocity calibration</p> <ul style="list-style-type: none"> Switches to the semiautomatic step block calibration mode. With the traditional text edit mode only, deletes the character at the cursor position.
		<p>Velocity</p> <ul style="list-style-type: none"> Opens a screen allowing you to view and manually change the sound velocity. In THRU-COAT mode, pressing the keys a second time allows you to view/adjust the velocity for the coating.

Table 1 Keypad functions (continued)

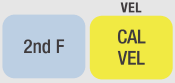
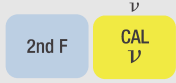
English	International	Functions
		Zero calibration <ul style="list-style-type: none"> • Compensates for transducer zero, or enables the step block zero calibration. • With the traditional text edit mode only, inserts a character at the cursor position.
		Do ZERO – Compensates for transducer delay for dual element transducers and the M2008 transducer.
		Setup menu – Provides access to instrument parameters (measurement, system, display, alarm, differential mode, communication, B-scan, DB grid, password, locks, resets, and SP [special] menu).
		On/Off – Turns the instrument power on or off.

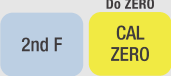
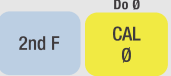
2. Powering the 45MG

This chapter describes how to power the 45MG using different power options.

2.1 Power Indicator

The power indicator is always present on the left side of the screen, and it shows the type of power source used. The 45MG can be powered by three AA-size batteries, by a computer through its USB connector, or by a commercially available 5-volt USB power supply.

When using batteries, the vertical green bar in the power indicator indicates the remaining battery level (see Figure 2-1 on page 37). Each graduation mark represents 20 % of the level.

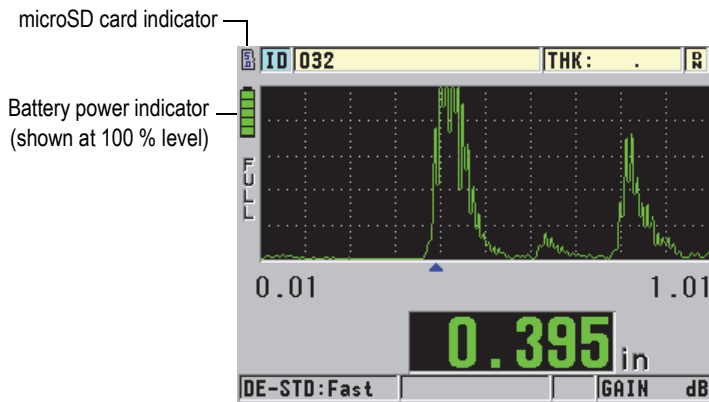

Figure 2-1 The power indicator when using batteries

When using a computer or a 5-volt USB power supply, the power indicator is represented by the **USB** logo, or by the **AC** logo, respectively (see Figure 2-2 on page 38).

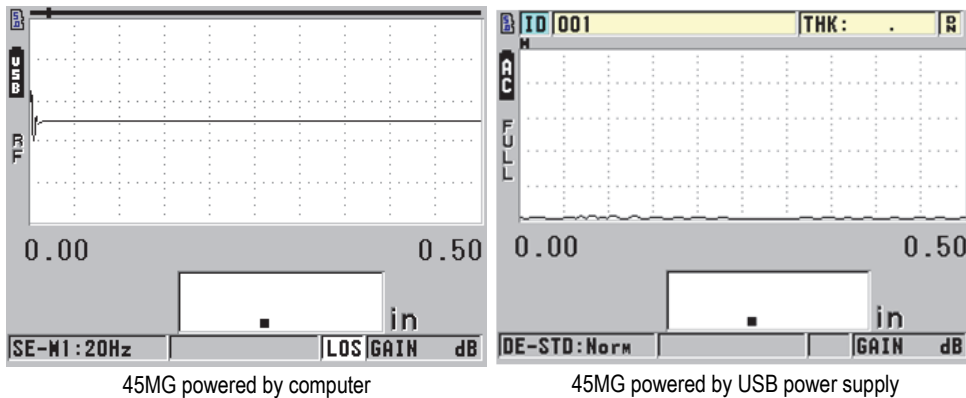

Figure 2-2 The power indicator when using a computer or an AC power supply

2.2 Battery Power

The 45MG comes with three AA-size alkaline batteries.

The 45MG can also be operated using three AA-size nickel-metal hydride (NiMH) rechargeable batteries, or three nonrechargeable AA-size lithium batteries. The 45MG does not recharge NiMH batteries. To recharge the batteries, you must use a commercially available external battery charger (not included).

2.2.1 Battery Operating Time

The battery operating time depends on the type of batteries being used, the age of the batteries, and the instrument settings. To provide realistic battery operating times, the 45MG has been tested with mid-level operating parameters (update rate set to 4 Hz and display brightness set to 20 %).

The nominal battery operating times for new batteries are:

- Alkaline: 20–21 hours (nonrechargeable)
- NiMH: 22–23 hours (externally recharged)

- Lithium: 35–36 hours (nonrechargeable)

2.2.2 Battery Level and Storage

NOTE

When the batteries are full (100 % level), the battery power indicator will show full bars.

Battery Storage Instructions

- Store batteries in a cool, dry environment.
- Avoid long-term storage under sunlight, or in other excessively hot places such as the trunk of an automobile.

2.2.3 Replacing the Batteries

The batteries are located in a compartment that is accessible from the back of the 45MG (see Figure 2-3 on page 39).

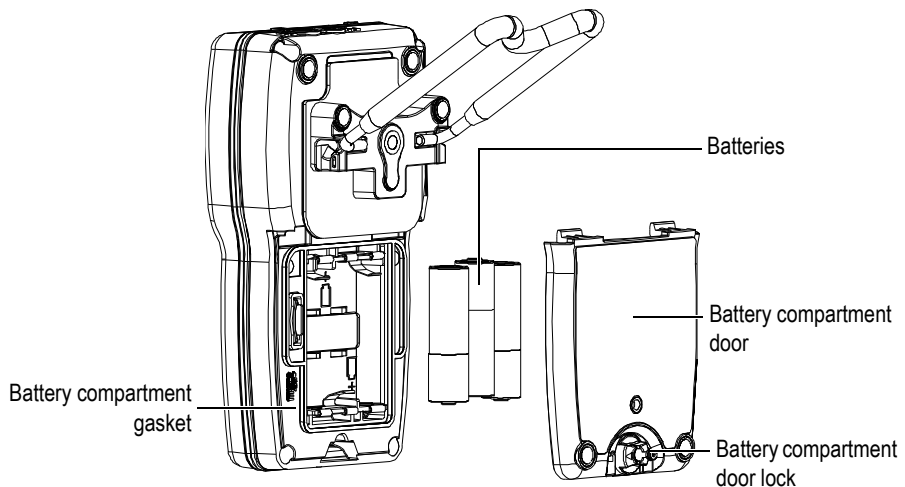



Figure 2-3 Opening the battery compartment

**CAUTION**

Do not replace the batteries while the instrument is on. Dispose of used batteries promptly. Keep batteries out of reach of children. The batteries used in this device may present a risk of fire or chemical burn if mistreated. Do not disassemble, heat above 50 °C, or incinerate the batteries.

To replace the batteries

1. Ensure that the power to the 45MG is turned off.
2. Disconnect any other cables connected to the 45MG.
3. Remove the optional protective rubber boot, if installed.
4. Turn the battery door lock half a turn counterclockwise to the unlock position.
5. Remove the battery compartment cover.
6. Remove the batteries.
7. Insert three new batteries in the battery compartment, making sure that you observe the correct polarity.
8. Ensure that the gasket inside the battery compartment cover is clean and in good condition.
9. Reinstall the battery compartment cover on the back of the instrument, push down on the bottom of the battery door, and then turn the battery door lock half a turn clockwise to the lock position.
10. Reinstall the optional protective rubber boot, if required.
11. Press  to turn on the 45MG instrument.
12. To answer the question appearing at the bottom of the screen (see Figure 2-4 on page 41):
 - ◆ Select **Alkaline** when using three AA-size alkaline batteries.
OR
Select **NiMH** when using three AA-size nickel-metal hydride (NiMH batteries).
OR
Select **Lithium** when using three AA-size lithium batteries.

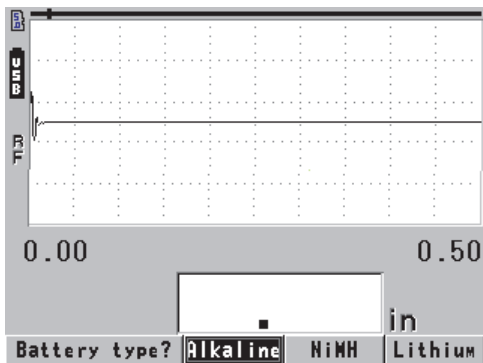

Figure 2-4 Selecting the battery type

NOTE

When replacing batteries, make sure that they are full in order to ensure the accuracy of the estimated remaining battery life shown by the power indicator.

3. Software User Interface Elements

The following sections describe the main elements of the 45MG software screens and menus.

3.1 Measurement Screen

The 45MG has two different main measurement screens:

The first screen (see Figure 3-1 on page 43) displays when the Waveform option is not activated, or when the Waveform option feature is turned off.

OR

The second screen (see Figure 3-2 on page 44) displays when the Waveform option is purchased and turned on.

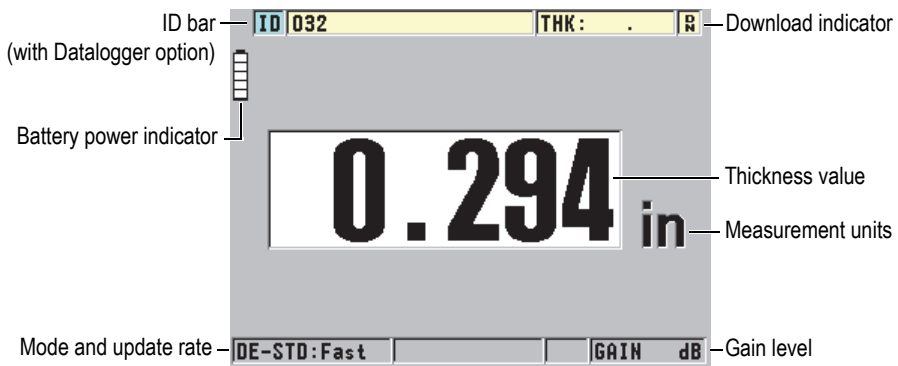

Figure 3-1 The measurement screen — No waveform enabled

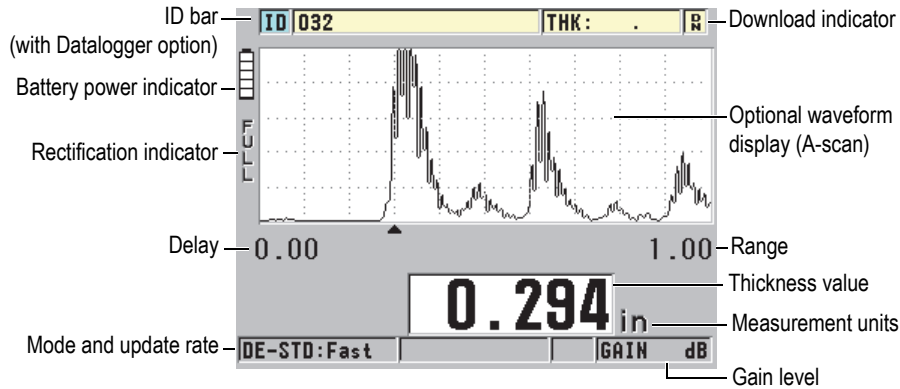

Figure 3-2 The measurement screen — Waveform option enabled

The measurement screen is the main screen of the 45MG software. From anywhere in the 45MG software, simply press [MEAS] to return to the measurement screen. The power indicator is always present on the left side of the 45MG screen (see “Power Indicator” on page 37 for details).

The optional waveform trace, called the A-scan, allows a skilled operator to verify that the signal used to make a thickness measurement is the correct back-wall echo, and not noise, material anomaly, or the second multiple echo. The A-scan also enables you to observe indications that may be too small to be measured by the instrument.

The ID bar (available with the Datalogger option), located at the top of the measurement screen, contains the ID for the actual thickness-measurement location and the previously stored value (see Figure 3-3 on page 44). The download indicator (R) appears when the previously stored thickness measurement comes from a file rather than a newly acquired value.

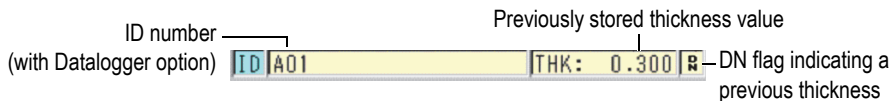



Figure 3-3 The ID bar

The indicator () of the optional external microSD memory card appears at the top left side of the screen when a microSD memory card is inserted in its slot, which is located in the battery compartment (see Figure 1-4 on page 31). The 45MG will recognize an external microSD memory card, with a maximum capacity of 2 GB, upon instrument start-up.

Depending on the context, and on the available functions and options, various indicators and numeric values appear around the waveform display and around the main measurement value (see Figure 3-4 on page 45 and Figure 3-5 on page 46). A help text bar will appear upon certain key presses in order to indicate the keys that can be used to navigate and make selections in the menu structure.

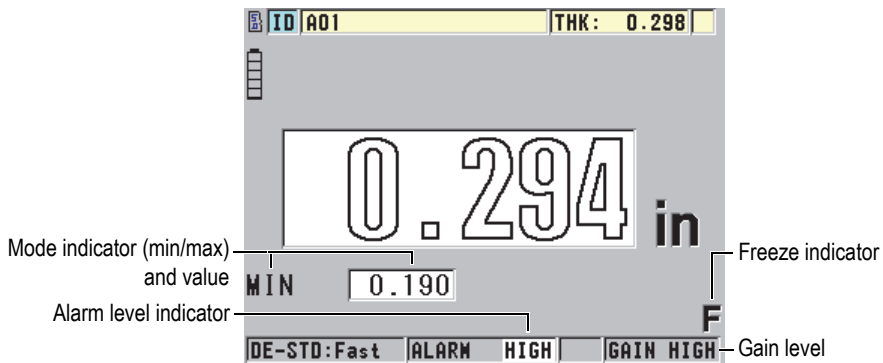

Figure 3-4 Other elements — No Waveform option enabled

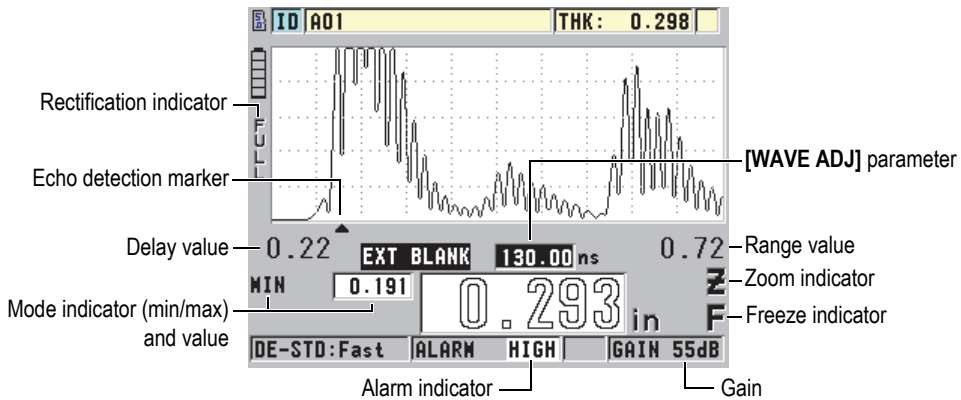

Figure 3-5 Other elements – Waveform option enabled

The loss of signal (LOS) appears and the thickness value is cleared when the 45MG no longer detects ultrasonic echoes (see Figure 3-6 on page 46).

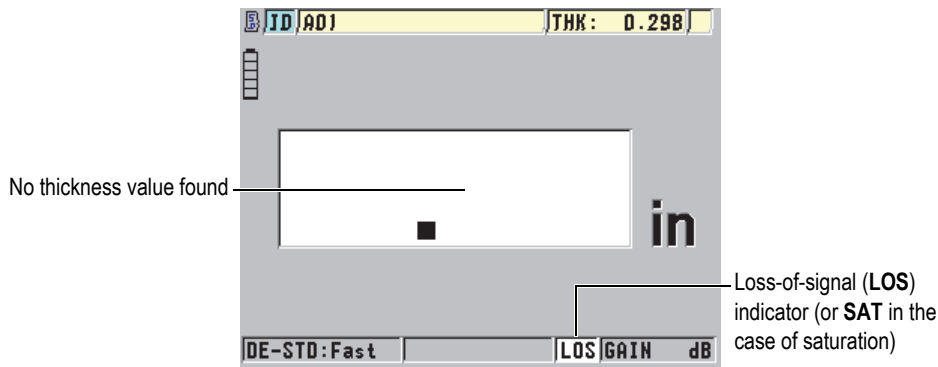

Figure 3-6 The loss-of-signal (LOS) indicator

In the rare case that the returning signal from the transducer is beyond the upper receiver-voltage limit, the LOS indicator will be replaced by the SAT flag for indication of saturation. This situation can normally be corrected by lowering the pulser voltage.

3.2 Menus and Submenus

The 45MG displays menus and submenus when you press certain front panel keys. The menu appears at the top-left corner of the screen (see Figure 3-7 on page 47). If applicable, a submenu conveniently showing the parameters available for the highlighted menu command also appears.

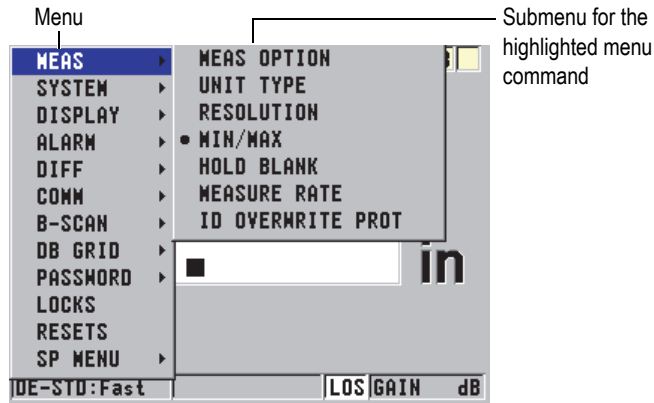

Figure 3-7 Menu and submenu example

To select a menu or a submenu command

1. Press [SETUP] or [FILE] (with the Datalogger option) to display a menu.
2. Use the [▲] and [▼] keys to highlight the desired menu command.
3. If applicable and needed, use the [▶] key to highlight the submenu, and then use the [▲] and [▼] keys to highlight the desired submenu command.
4. Press [ENTER] to select the highlighted menu or submenu command.

NOTE

In the remainder of this document, the above procedure is summarized by a simple instruction to select a specific menu or submenu command. For example: “In the menu, select **MEAS**.”

3.3 Parameter Screens

The 45MG parameters are logically grouped in parameter screens that can be accessed using front panel keys or menu commands. Figure 3-8 on page 48 shows the **MEAS** parameter screen as an example.

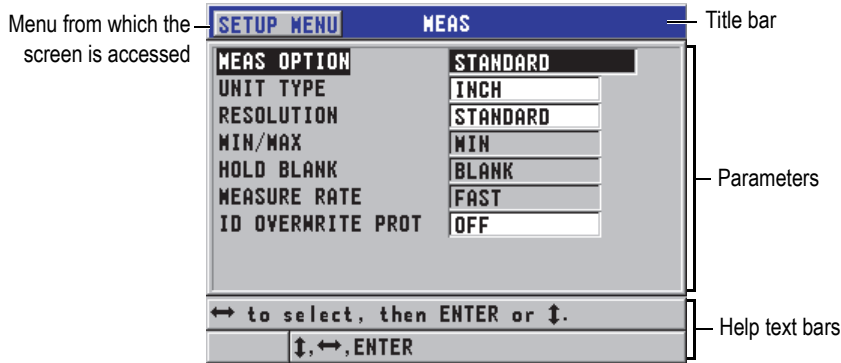

Figure 3-8 Parameter screen example

The title bar, located at the top of the parameter screen, indicates the parameter subject. When you access a parameter screen from a menu, a menu button appears on the left side of the title bar. This menu button can be used to easily return to the original menu. One or two help text bars appear at the bottom of the screen to indicate the keys required to select a parameter and edit its value.

To select a parameter and edit its value

1. Use the [▲] and [▼] keys to highlight the desired parameter.
2. For parameters with predefined values, use the [▶] and [◀] keys to select the desired value.
3. In parameter screens containing lists or alphanumeric parameters:
 - In a list, use the [▲] and [▼] keys to highlight the desired list item.
 - For an alphanumeric parameter, use the [▲] and [▼] keys to enter the desired characters (see “Selecting the Text Edit Mode” on page 49 for details).
 - Press [2nd F], [▼] or [2nd F], [▲] to leave a list or alphanumeric parameter, and proceed to the next or previous screen element.
4. To exit the parameter screen, press [MEAS] to return to the measurement screen.

NOTE

In the remainder of this document, the above procedure is summarized by the simple instruction to select a specific parameter or list, and its value. For example: “In the **MEAS** screen, set **MEAS MODE** to **THICKNESS**.”

3.4 Selecting the Text Edit Mode

The 45MG offers two methods of editing the value of alphanumeric parameters. Either the virtual keyboard or traditional method can be used. The virtual keyboard appears on the screen to display all the available characters that can be used (see “Editing Text Parameters Using the Virtual Keyboard” on page 49 for details). With the traditional method, you must select each character from a hidden list of standard sorted letters, numbers, and special characters (see “Editing Text Parameters Using the Traditional Method” on page 51 for details).

To select the text edit mode

1. In the measurement screen, press **[SETUP]**, and then select **SYSTEM**.
2. In the **SYSTEM** screen, highlight **TEXT EDIT MODE**, and then select the desired mode (**VIRTUAL** or **TRADITIONAL**).
3. Press **[MEAS]** to return to the measurement screen.

3.4.1 Editing Text Parameters Using the Virtual Keyboard

When **TEXT EDIT MODE** is set to **VIRTUAL**, the virtual keyboard appears when an alphanumeric parameter is selected (see Figure 3-9 on page 50).

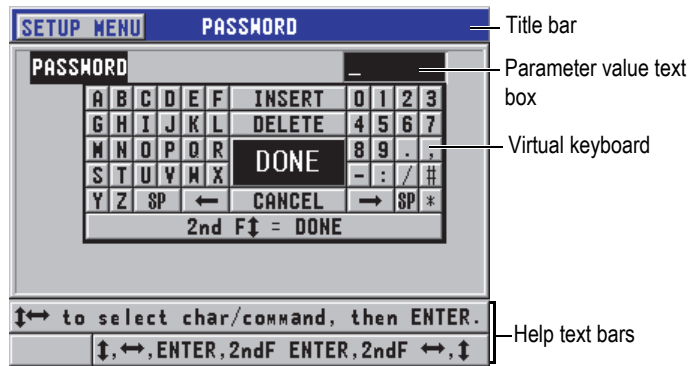

Figure 3-9 Example of the virtual keyboard

To edit an alphanumeric parameter value using the virtual keyboard

1. Select an alphanumeric parameter.

The virtual keyboard appears.
2. Use the [▲], [▼], [▶], and [◀] keys to highlight the character that you wish to enter, and then press [ENTER].

The selected character appears in the parameter value text box, and the cursor moves to the next character position.
3. Repeat the previous step to enter other characters.
4. If you need to move the position of the cursor in the value text box, highlight either the left (◀) or right (▶) arrow button on the virtual keyboard, and then press [ENTER].

The cursor moves by one character position.
5. When you need to delete a character:
 - a) Move the cursor to the character you wish to delete.
 - b) On the virtual keyboard, highlight **DELETE**, and then press [ENTER].
6. When you need to insert a character:
 - a) Move the cursor to the character in front of which you wish to insert a character.
 - b) On the virtual keyboard, highlight **INSERT**, and then press [ENTER].
 - c) Enter the desired character in the inserted space.
7. If you want to cancel the editing operation and return to the original parameter value, highlight **CANCEL** on the virtual keyboard, and then press [ENTER].

8. To complete editing of the parameter value, highlight **DONE** on the virtual keyboard, and then press **[ENTER]**.

NOTE

When editing a multiple line parameter value, highlight **DONE** and press **[ENTER]** to move the cursor to the next line. You can also press **[2nd F]**, **[▼]** to accept the text and move the cursor to the next line.

3.4.2 Editing Text Parameters Using the Traditional Method

When the **TEXT EDIT MODE** is set to **TRADITIONAL**, select each character from a hidden circular list of standard sorted letters, numbers, and special characters (see Figure 3-10 on page 51). Only uppercase letters are available.

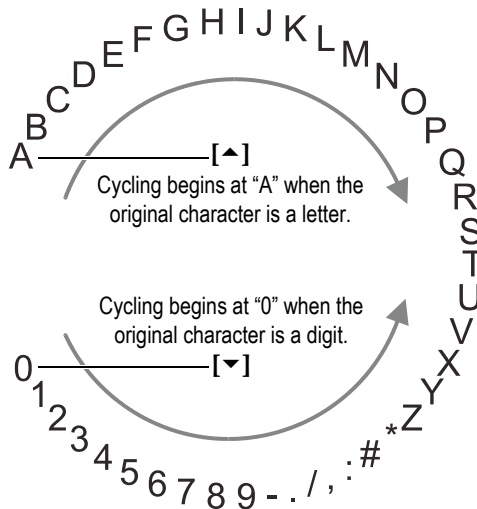

Figure 3-10 The character cycle of the traditional text edit method

To edit an alphanumeric parameter value using the traditional method

1. Select an alphanumeric parameter.

2. Use the [▲] and [▼] keys to select the character you want to enter. Hold down the key to quickly cycle through the letters, numbers, and special characters.
3. Use the [▶] keys to move to the next character.
4. Repeat step 2 and step 3 to enter other characters.
5. If you need to move the position of the cursor in the value text box, use the [▶] or [◀] key.
6. To insert a character at the cursor position, press [CAL ZERO].
The character at the cursor, and all those to the right, move one position to the right, making space for one new character.
7. To delete the character at the cursor position, press [CAL VEL].
The character at the cursor is deleted, and any characters to the right move to the left by one position.
8. Press [ENTER] to accept the character string and move to the next parameter.

4. Initial Setup

The following sections describe basic system configurations.

4.1 Setting the User Interface Language and Other System Options

The 45MG can be configured to display the user interface in the following languages: English, German, French, Spanish, Japanese, Chinese, Russian, Swedish, Italian, Norwegian, Portuguese, or Czech. You can also set the character delimiting the radix of a number.

The 45MG includes a beep tone generator that confirms when a key is pressed and notifies you of an alarm condition. The beeper can be set to On or Off.

To save battery power while the instrument is not in use, enable the inactive time function so that the instrument automatically turns off when no key has been pressed and no measurement has been made within a period of about six minutes.

To change the user interface language and other system options

1. In the measurement screen, press **[SETUP]**, and then select **SYSTEM**.
2. In the **SYSTEM** screen (see Figure 4-1 on page 54):
 - a) Set **BEEPER** to **ON** or **OFF**.
 - b) Set **INACTIVE TIME** to **ON** or **OFF**.
 - c) Set **LANGUAGE** to the desired language.
 - d) Set **RADIX TYPE** to the desired character (**PERIOD** or **COMMA**) in order to separate the integer and the decimal digits.



Figure 4-1 The SYSTEM screen

3. Press **[MEAS]** to return to the measurement screen.
4. Turn off the 45MG, and then turn it back on to activate the language change.

4.2 Selecting the Measurement Units

The 45MG can be set to show thickness measurements in inches or millimeters.

To set the measurement units

1. In the measurement screen, press **[SETUP]**, and then select **MEAS**.
2. In the **MEAS** screen, set **UNIT TYPE** to **INCH** or **MILLIMETER**.
3. Press **[MEAS]** to return to the measurement screen.

4.3 Setting the Clock

The 45MG has a built-in date and time clock. You can set the date and the time and select their format. The 45MG saves all measurement values with their acquisition date.

To set the clock

1. In the measurement screen, press **[SETUP]**, and then select **SP MENU**.
2. In the **SP MENU** (see Figure 4-2 on page 55), select **CLOCK**.

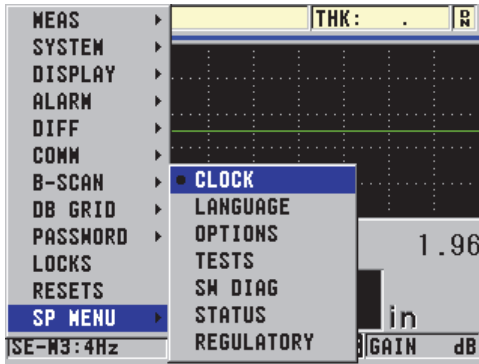

Figure 4-2 The SP MENU screen

3. In the **CLOCK** screen (see Figure 4-3 on page 55), set the parameters to the current date and time.
4. Set the desired **DATE MODE** and **HOUR MODE**, and then select **SET**.

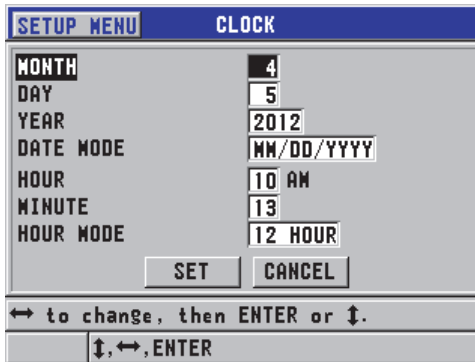

Figure 4-3 The CLOCK screen

4.4 Changing Display Settings

The appearance of certain display elements, such as colors, brightness, waveform rectification, and waveform trace, can be changed.

To change the display settings

1. In the measurement screen, press [SETUP], and then select **DISPLAY**.

NOTE

Many of the display parameters are only visible when the Waveform or Datalogger options have been activated.

2. In the **DISPLAY** screen (see Figure 4-4 on page 56), select the desired parameter and value for the following parameters:
 - **WAVEFORM ENABLE** allows you to activate or deactivate the waveform display (see “Waveform Software Option” on page 88 for details).
 - **ZOOM OPTION** allows you to activate or deactivate the zoom function (see “Activating the Zoom Function (Available Only with the Waveform Option)” on page 94 for details).
 - **RECTIFICATION** allows you to select one of the rectification modes (see “Waveform Rectification” on page 90 for details).
 - **WAVEFORM TRACE** is used to select one of the trace types (see “Waveform Trace” on page 92 for details).
 - **COLOR SCHEME** is used to select either the **INDOOR** or **OUTDOOR** optimized visibility (see “Color Schemes” on page 57 for details).
 - **DISPLAY BRIGHTNESS** is used to select one of the predefined brightness levels (see “Display Brightness” on page 58 for details).
 - **ID REVIEW LINE** is used to activate or deactivate the feature.

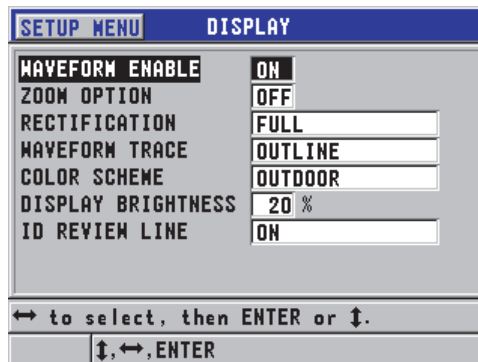

Figure 4-4 The DISPLAY screen

3. Press [MEAS] to return to the measurement screen.

4.4.1 Color Schemes

The 45MG offers two standard color schemes designed to provide the best display visibility in indoor or outdoor lighting conditions (see Figure 4-5 on page 57).

To set the color scheme

1. In the measurement screen, press [SETUP], and then select **DISPLAY**.
2. In the **DISPLAY** screen (see Figure 4-4 on page 56), set the **COLOR SCHEME** to **INDOOR** or **OUTDOOR**.
3. Press [MEAS] to return to the measurement screen.

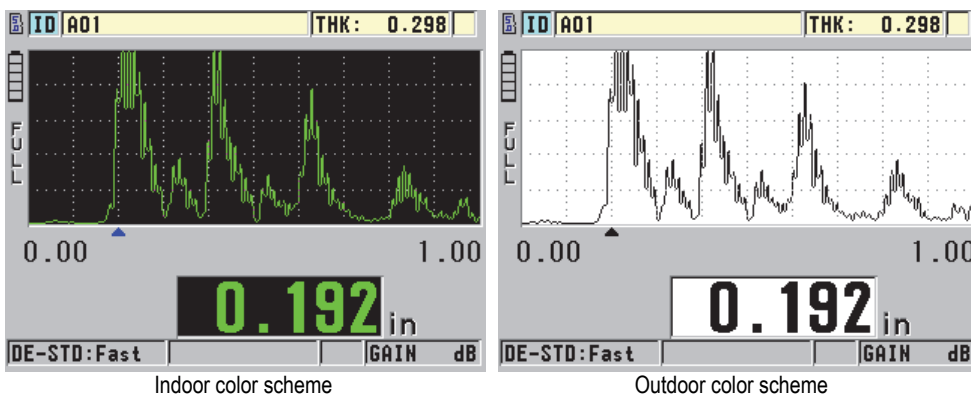

Figure 4-5 Example of the indoor and the outdoor color schemes

The indoor scheme gives the best visibility when the instrument is used indoors or in low-light conditions. The indoor scheme displays green characters and waveform trace on a black background.

The outdoor scheme provides the best visibility when the instrument is used in direct sunlight. The outdoor mode displays black characters and waveform trace on a white background. For best readability in this document, most screen captures are shown in the outdoor color scheme.

NOTE

Colored measurement values corresponding to specific alarm conditions only appear when the indoor color scheme is selected.

4.4.2 Display Brightness

The 45MG display brightness can be adjusted by selecting the backlight intensity. The display brightness can be set in 5 % increments from 0 % to 100 %. Choosing a high percentage increases the brightness of the display. By default, the display brightness is set to 20 %.

To set the display brightness

1. In the measurement screen, press **[SETUP]**, and then select **DISPLAY**.
2. In the **DISPLAY** screen (see Figure 4-4 on page 56), set the **DISPLAY BRIGHTNESS** to the desired percentage level.
3. Press **[MEAS]** to return to the measurement screen.

The 45MG uses a transfective color display that reflects ambient light and becomes brighter in direct light. In brighter ambient conditions, the display brightness can be set to a lower percentage.

NOTE

Reducing the display brightness percentage increases the battery life. Battery life specifications are based on the backlight brightness set to 20 %.

4.5 Adjusting the Measurement Update Rate

It is possible to select a predefined measurement update rate. When using dual element transducers, the user can select between two measurement update rates: **Normal** (4 Hz) or **Fast** (up to 20 Hz). Normal is the default setting for the measurement update rate. When the Single Element option is activated and while

using a single element transducer, it is possible to select **4 Hz**, **8 Hz**, **16 Hz**, or **Max** (up to 20 Hz). The measurement update rate indicator is permanently displayed on the left side of the thickness measurement (see Figure 4-6 on page 59).

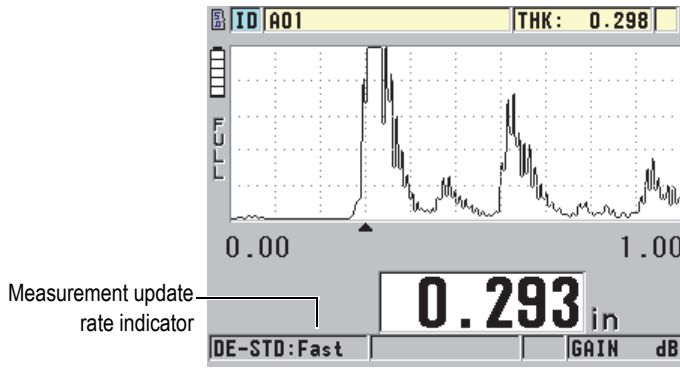

Figure 4-6 The measurement update rate indicator

The **Fast** update rate can be as high as 20 Hz, and is dependent on the measurement type. This option is useful when making high-temperature thickness measurements in order to help limit transducer contact time, or for applications where the transducer is scanned over an area in order to determine the minimum thickness.

NOTE

The 45MG automatically uses the fastest update rate when put into the **Minimum** or **Maximum** mode (see “Using the Minimum, Maximum, or Min/Max Thickness Mode” on page 139).

To adjust the measurement update rate

1. In the measurement screen, press [SETUP], and then select **MEAS**.
2. In the **MEAS** screen (see Figure 8-1 on page 150), set the **MEASURE RATE** to the desired value.
3. Press [MEAS] to return to the measurement screen.

4.6 Changing the Thickness Resolution

It is possible to change the thickness-measurement resolution, meaning the number of digits shown to the right of the decimal point. The resolution selection affects all displays and data output of values with thickness units. This includes measured thickness, differential reference value, and alarm set points. The highest thickness resolution with a dual element transducer is 0.01 mm (or 0.001 in.). The velocity is always reported with full four-digit resolution.

The resolution can be reduced in certain applications where the extra precision of the last digit is not required, or where extremely rough outside or inside surfaces make the last thickness display digit unreliable.

The Single Element including High Resolution software option (P/N: 45MG-SE [U8147022]) makes it possible to increase the resolution to 0.001 mm (or 0.0001 in.). High resolution is available for measured thickness smaller than 102 mm (4 in.). High resolution is not active with low-frequency transducers, or when the High Penetration software option is activated.

To change the thickness-measurement resolution

1. In the measurement screen, press **[SETUP]**, and then select **MEAS**.
2. In the **MEAS** screen (see Figure 8-1 on page 150), set **RESOLUTION** to the desired option:
 - **STANDARD**: 0.01 mm (or 0.001 in.) [default]
 - **LOW**: 0.1 mm (or 0.01 in.)
 - Optional **HIGH**: 0.001 mm (or 0.0001 in.)
3. Press **[MEAS]** to return to the measurement screen.

5. Basic Operation

The following sections describe the basic operation for the 45MG ultrasonic thickness gauge.

5.1 Setting Up the Transducer

The 45MG operates with a full line of single element (optional software) and dual element transducers. The 45MG automatically recognizes standard D79X dual element transducers, and automatically loads the appropriate predefined setup. The predefined setup contains ultrasonic velocity for the stainless steel step block supplied with the instrument. With dual element transducers, you need to perform a transducer zero compensation.

For Single Element or High Penetration software options and single element transducers, you need to manually recall an appropriate setup. The 45MG is factory shipped with default conditions for the purchased transducers set up using an approximate sound velocity for the stainless steel test block provided with the instrument. The default conditions are selected to facilitate instrument usage for your applications.

To set up the transducer

1. Plug the transducer into the transducer connector(s) on the top of the 45MG case (see Figure 5-1 on page 62), using only T/R 1 for a single element transducer.

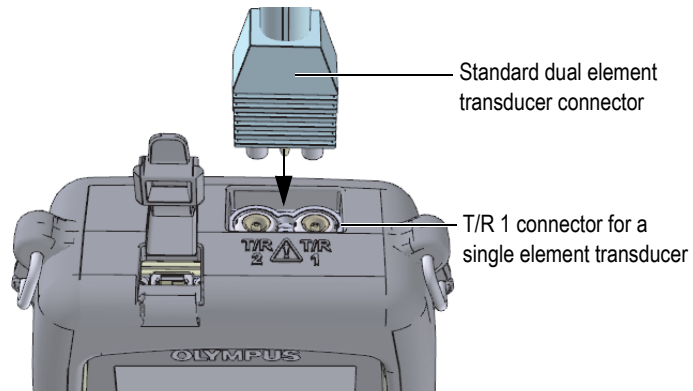



Figure 5-1 Plugging in the transducer

2. Press  to start the instrument.

The measurement screen appears. With a standard D79X dual element transducer, the “Do--” message appears in the measurement screen (see Figure 5-2 on page 62).

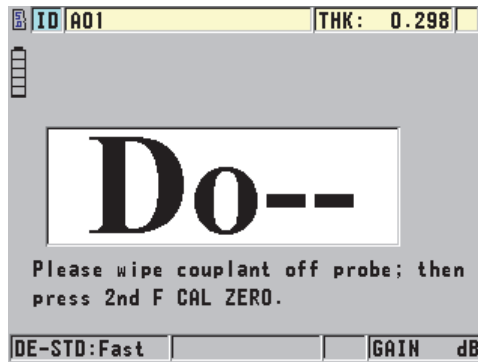
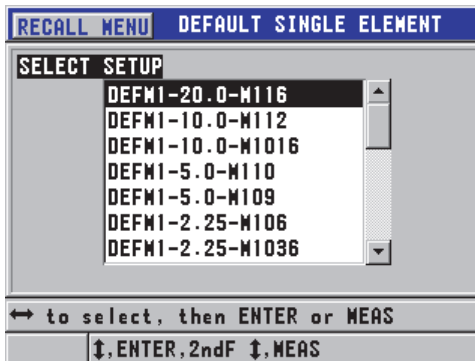

Figure 5-2 Initial screen with a standard D79X dual element transducer

3. For dual element transducers, perform the transducer zero compensation:
 - a) Wipe the couplant off the tip of the transducer.
 - b) Press [2nd F], [CAL ZERO] (Do ZERO).

4. For the Single Element software option and a single element transducer, load an appropriate setup:
 - a) Press [2nd F], [FREEZE] (XDCR RECALL).
 - b) In the menu, select the default choice for the probe type that you use (ex.: **DEFAULT SINGLE ELEMENT**).
 - c) In the **DEFAULT** screen for the type of probe you are using (see the example shown in Figure 5-3 on page 63), highlight the setup in the list of available default setups for the transducer that you are using.



Default setup naming convention:

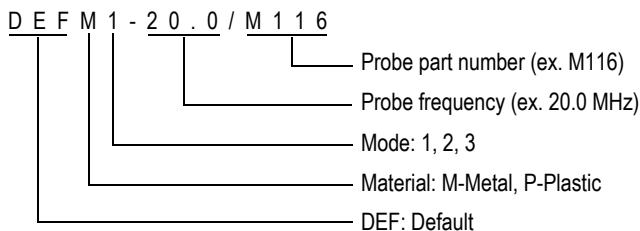

Figure 5-3 Selecting a default single element transducer setup

NOTE

The setups listed as USER-1 through USER-35 can be renamed for special applications. Refer to “Custom Setups for Single Element Transducers” on page 173 for more details on setups.

- d) Press **[MEAS]** to automatically recall the setup parameters for the chosen setup and return to the measurement screen.

5.2 Calibration

Calibration is the process of adjusting the instrument to perform accurate measurements on a particular material at a given temperature using a known transducer. Calibration of the instrument is always necessary prior to inspection of a specific material. The measurement accuracy is only as accurate as the calibration performed.

The following three types of calibration must be performed:

Transducer zero compensation (**[Do ZERO]**)

For dual element transducers only, calibrate for the sound transit time in each of the dual transducer delay lines. This compensation varies in each transducer unit, and with the temperature. The transducer zero-compensation procedure must be performed whenever the unit is powered on, the transducer is changed, or the transducer temperature changes significantly (see “Setting Up the Transducer” on page 61 and “Transducer Zero Compensation” on page 68).

Material sound velocity calibration (**[CAL VEL]**)

Perform a velocity calibration using a thick test block of the measured material, and of known thickness, or by manually entering a previously determined material sound velocity. You must perform this procedure for each new measured material (see “Calibrating the Instrument” on page 65 and “Material Sound Velocity and the Zero Calibrations” on page 69).

Zero Calibration (**[CAL ZERO]**)

Perform a zero calibration using a thin test block of the measured material, and of known thickness. Unlike the transducer zero compensation and the material sound velocity calibration, this procedure is not required unless you need the best absolute accuracy (better than ± 0.10 mm or ± 0.004 in.). The procedure only needs to be performed once for each new transducer and material combination. It is not necessary to repeat the zero calibration when the transducer temperature changes; transducer zero compensation is responsible for that task (see “Calibrating the Instrument” on page 65 and “Material Sound Velocity and the Zero Calibrations” on page 69).

5.2.1 Calibrating the Instrument

To make accurate measurements, you need to perform the following calibrations:

- Material sound velocity calibration
- Zero calibration

The calibrations must be performed using a thick and a thin sample of precisely known thicknesses. The sample must be made of the same material as the parts to be inspected (see “Test Blocks” on page 68 for details on test blocks).

The following procedure is illustrated using a dual element probe and a five-step test block. Refer to “Calibration” on page 64 for more details on the calibration process.

To calibrate the instrument

1. To perform the material sound velocity calibration using an instrument with or without the Waveform software option (see Figure 5-5 on page 66):
 - a) Place a drop of couplant on the surface of the thick part of the test block.
 - b) Couple the transducer to the thick part of the test block using moderate to firm pressure (see Figure 5-4 on page 65).

The waveform (optional) and the thickness reading appear on the screen.
 - c) Press **[CAL VEL]**.
 - d) Once the thickness reading is stable, press **[ENTER]**.
 - e) Using the arrow keys, edit the thickness value to match the known thickness of the thick part of the test block.

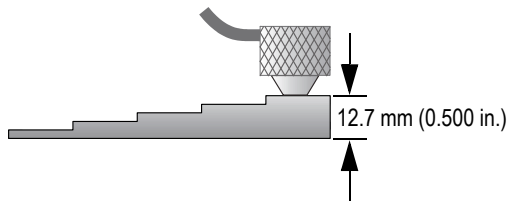

Figure 5-4 Sound velocity calibration on a five-step test block — Thick part

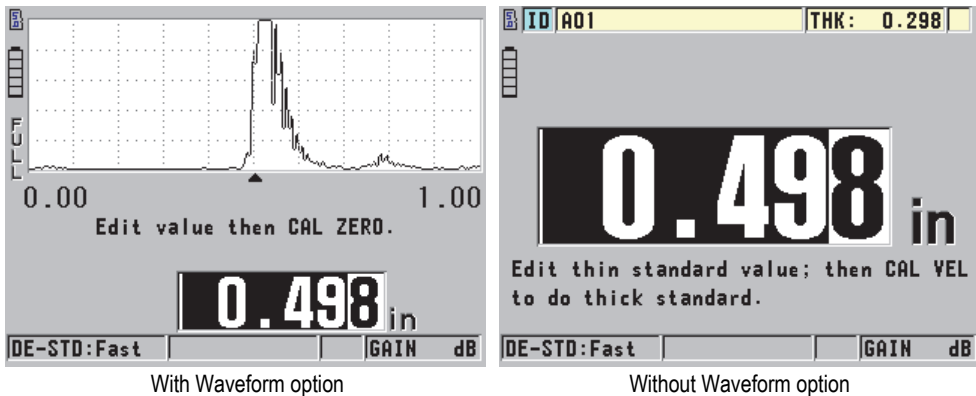

Figure 5-5 Performing the sound velocity calibration on a five-step test block

2. To perform the zero calibration using an instrument with or without the Waveform option (see Figure 5-7 on page 67):
 - a) Place a drop of couplant on the surface of the thin part of the test block.
 - b) Couple the transducer to the thin part of the test block (see Figure 5-6 on page 66), and then press **[CAL ZERO]**.
 - c) Once the thickness reading is stable, press **[ENTER]**.
 - d) Using the arrow keys, edit the thickness value to match the known thickness of the thin part of the test block.

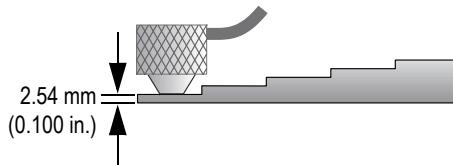

Figure 5-6 Sound velocity calibration on a five-step test block — Thin part

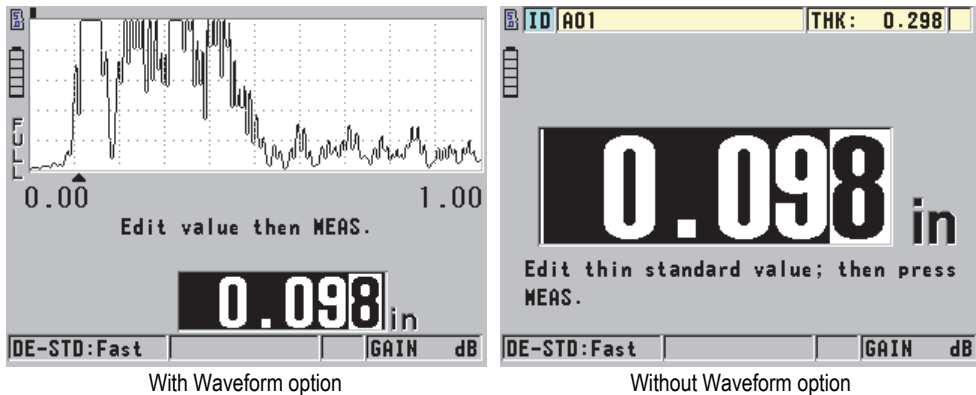

Figure 5-7 Performing the zero calibration on a five-step test block

3. Press **[MEAS]** to complete the calibration and return to the measurement screen.

IMPORTANT

If you turn off the instrument before pressing **[MEAS]**, the velocity will not be updated to the new value. Instead, the instrument retains the previous value.

NOTE

When the 45MG detects an error in the calibration procedure, it successively displays the following messages in the help text bar before returning to the measurement screen:

“Potential wrong echo detected!”

“Invalid calibration results!”

In such case, the velocity is not changed. The probable cause is that an incorrect thickness value was entered, or the incorrect back-wall echo was detected.

5.2.2 Test Blocks

The 45MG comes with a cylindrical stainless steel test block with two thicknesses. Two precisely known test-block thicknesses can be used to perform the material sound velocity and the zero calibrations.

Precision step test blocks are also often used when more than two known thicknesses are needed (see Figure 5-8 on page 68).



Figure 5-8 Example of a five-step test block

When performing the material sound velocity and zero calibrations, you must use a test block with the following characteristics:

- Made from the same material as the part to be tested.
- Has two or more precisely known thicknesses.
- Has one part as thin as the thinnest section of the parts to be tested in order to perform the zero calibration. The surface condition should be similar to that of the tested parts. Rough surfaces generally reduce the accuracy of measurements, but simulating actual surface conditions on the calibration block can help to improve results.
- Has one part as thick as the thickest section of the parts to be tested, in order to perform the material sound velocity calibration. The front and back surfaces should be smooth and parallel.
- Be at the same temperature as the samples to be measured.

5.2.3 Transducer Zero Compensation

Perform a transducer zero compensation by pressing **[2nd F]**, **[CAL ZERO]** (**Do ZERO**) whenever the zero indicator (**Do--**) appears. This procedure should also be performed when the dual element transducer temperature has changed.

The frequency at which you perform a transducer zero-compensation procedure depends on the rate of change of the internal temperature of the dual element transducer. This is related to the material surface temperature, the frequency of transducer application, the length of time the transducer is held in contact with the material, and the accuracy that you want to obtain.

NOTE

When measurements are made on surfaces that are significantly above room temperature, the zero point should be recalibrated on a regular basis. This is less important for transducers with part numbers D790-SM, D791-RM, D797-SM, and D798 than for other transducers with various types of resin delay lines.

For high-temperature measurements, Evident recommends developing a transducer zero-compensation schedule that takes these factors into account. For example, use the D790-SM, D791-RM, or D797-SM for high-temperature applications, thereby minimizing the frequency of the zero compensation. The D790-SM and D791-RM can also be used for general-purpose applications.

5.2.4 Material Sound Velocity and the Zero Calibrations

The 45MG performs a calibration doubling verification to help prevent mis-calibration on thin samples. Doubling occurs when the instrument measures the time of flight to the second back-wall echo rather than measuring the time of flight to the first back-wall echo. The 45MG compares the measured time of flight to the expected time of flight based on the current sound velocity. The 45MG displays a warning message if doubling is suspected. Doubling can occur when measuring a thickness that is below the minimum range of the transducer, or when using a transducer that is worn out, or getting low in sensitivity.

NOTE

You can also achieve a material sound velocity and zero calibration procedure by performing the operations in the reverse order, starting with the zero calibration, followed by the material sound velocity calibration.

5.2.5 Entering a Known Material Sound Velocity

When preparing to measure thicknesses on parts made of a different material, if you know the sound velocity for the material, you can enter it directly without performing a material sound velocity calibration procedure.

To enter a known material sound velocity

1. In the measurement screen, press **[2nd F]**, **[CAL VEL]** (**VEL**).
2. In the **VELOCITY** screen (see Figure 5-9 on page 70), use the arrow keys to edit the velocity to the known value.

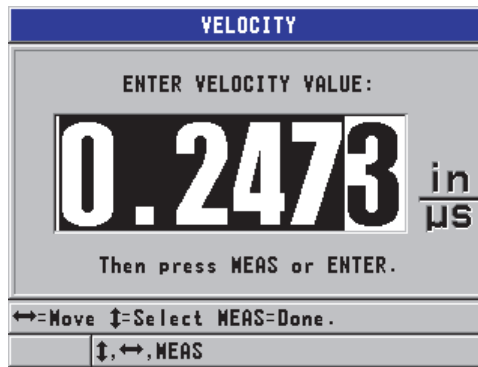

Figure 5-9 Entering a known material sound velocity

3. Press **[MEAS]** to return to the measurement screen.

5.2.6 Locked Calibrations

The 45MG includes a password-protected locking function to prevent changes to setups, and prevent access to certain functions. A change to the calibration is one action that can be locked. In such case, the message shown in Figure 5-10 on page 71 appears momentarily on the help text bar (see "Locking the Instrument" on page 146 for details).



Figure 5-10 The calibration lock message

5.2.7 Factors Affecting Performance and Accuracy

The following factors affect the performance of the instrument and the accuracy of the thickness measurements.

Calibration

The accuracy of any ultrasonic measurement is only as good as the accuracy and care with which you calibrate the instrument. The 45MG ships from the factory with standard setups for a number of transducers and applications. In certain cases, it may be desirable to optimize these setups for specific measurement situations. In all cases, it is essential to perform the velocity and zero calibrations whenever the test material or transducer is changed. Periodic checks with samples of known thicknesses are recommended to verify that the gauge is operating properly.

Surface roughness of the test piece

The best measurement accuracy is obtained when both the front and back surfaces of the test piece are smooth. When the contact surface is rough, the minimum thickness that can be measured will be increased as a result of sound reverberating in the increased thickness of the couplant layer. Additionally, when the two test-piece surfaces are rough, the slightly different multiple sound paths seen by the transducer may cause distortion in the returning echo, resulting in measurement inaccuracies.

Coupling technique

In mode 1 (contact transducer) measurements, the couplant layer thickness is part of the measurement, and is compensated by a portion of the zero offset. If maximum accuracy is to be achieved, the coupling technique must be consistent. In order to accomplish consistent measurements, use a couplant of reasonably low viscosity, employ only enough couplant to achieve a reasonable reading, and apply the transducer with uniform pressure. Practice will determine the degree of moderate to firm pressure needed to produce repeatable readings. In general, smaller-diameter transducers require less coupling force to squeeze out excess

couplant than larger-diameter transducers. In all modes, tilting the transducer distorts echoes, and causes inaccurate readings, as noted below.

Curvature of the test piece

A related issue involves the alignment of the transducer with respect to the test piece. When measuring on curved surfaces, it is important that the transducer be placed approximately on the centerline of the part, and held steadily as close to the surface as possible. In some cases, a spring-loaded V-block holder may be helpful in maintaining this alignment. In general, as the radius of curvature decreases, the size of the transducer should be reduced, and transducer alignment becomes more critical. For very small radii, an immersion approach is necessary. In some cases, it may be useful to observe the waveform display as an aid to maintaining optimum alignment. Observe the best method for holding a transducer with the aid of a waveform display. On curved surfaces, it is important to use only enough couplant to obtain a reading. Excess couplant forms a fillet between the transducer and the test surface where sound reverberates, and possibly creates spurious signals that may trigger false readings.

Taper or eccentricity

If the contact surface or back surface of the test piece is tapered or eccentric with respect to the other, the return echo is distorted due to the variation of the sound path across the width of the beam. The accuracy of the measurement is therefore reduced. In severe cases, no measurement is possible.

Acoustic properties of the test material

There are several conditions in certain engineering materials that can potentially limit the accuracy and range of ultrasonic thickness measurements:

- Sound scattering:

In materials such as cast stainless steel, cast iron, fiberglass, and composites, sound energy scatters from individual crystallites in the casting, or from boundaries of dissimilar materials within the fiberglass or composite. Porosity in any material can have the same effect. Adjust the instrument sensitivity to prevent detection of these spurious scatter echoes. This compensation can in turn limit the ability to discriminate a valid return echo from the back wall of the material, thereby restricting the measurement range.

- Sound attenuation or absorption:

In many organic materials, such as low-density plastics and rubbers, sound energy is attenuated very rapidly at the frequencies used for ultrasonic gaging. This attenuation typically increases with temperature. The maximum thickness that can be measured in these materials is often limited by attenuation.

— Velocity variations:

An ultrasonic thickness measurement is accurate only to the degree that material sound velocity is consistent with the instrument calibration. Some materials exhibit significant variations in sound velocity from point to point. This happens in certain cast metals due to the changes in grain structure that result from varied cooling rates, and the anisotropy of sound velocity with respect to grain structure. Fiberglass can show localized velocity variations due to changes in the resin/fiber ratio. Many plastics and rubbers show a rapid change in sound velocity with temperature, and as such, velocity calibration must be performed at the temperature of the location where the measurements are made.

Phase reversal or phase distortion

The phase or polarity of a returning echo is determined by the relative acoustic impedances (density \times velocity) of the boundary materials. The 45MG performs computation based on the customary situation, where the test piece is backed by air or a liquid, both of which have a lower acoustic impedance than metals, ceramics, or plastics. However, in some specialized cases, such as measurement of glass or plastic liners over metal, or copper cladding over steel, this impedance relationship is reversed, and the echo appears phase-reversed. In such cases, it is necessary to change the appropriate echo detection polarity in order to maintain accuracy (see "Detection of Echo 1 and Echo 2" on page 187). A more complex situation can occur in anisotropic or inhomogeneous materials, such as coarse-grain metal castings or certain composites, where material conditions result in the existence of multiple sound paths within the beam area. In such cases, phase distortion can create an echo that is neither cleanly positive nor negative. Careful experimentation with reference standards is necessary in such cases in order to determine the effects on measurement accuracy.

5.3 Measuring Thicknesses

You can start performing thickness measuring as soon as a transducer is connected (see "Setting Up the Transducer" on page 61) and the instrument is calibrated (see "Calibrating the Instrument" on page 65).

To measure thicknesses

1. Apply couplant to the measurement spot on the test block or tested part.

NOTE

In general, use a thinner couplant (such as propylene glycol, glycerin, or water) for smooth material surfaces. Rough surfaces require a more viscous couplant, such as gel or grease. Special couplants are required for high-temperature applications.

- Using moderate to firm pressure, couple the tip of the transducer to the surface of the test material, and keep the transducer as flat as possible on the material surface (see Figure 5-11 on page 74).

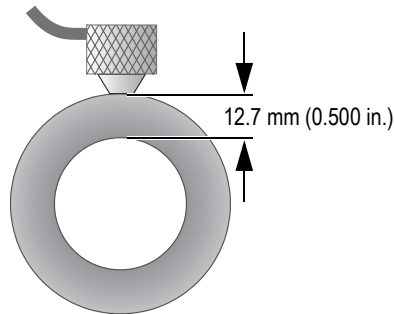

Figure 5-11 Coupling a dual element transducer

- Read the measured thickness value for the tested part (see Figure 5-12 on page 75).

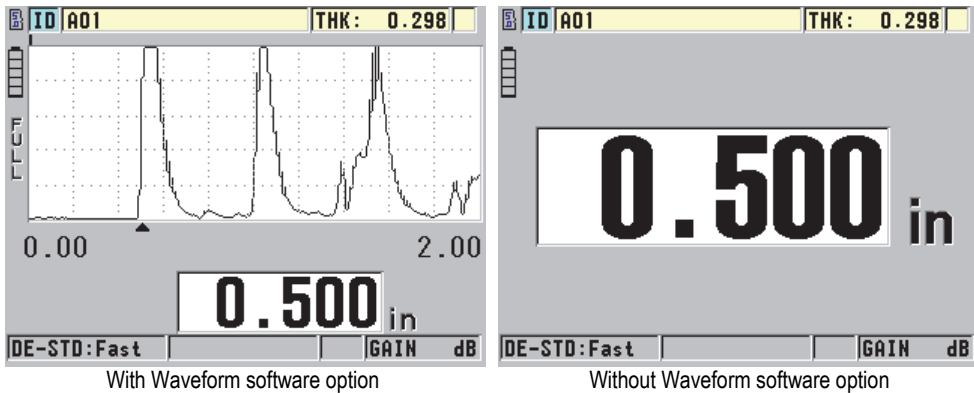

Figure 5-12 Reading the measured thickness

5.4 Saving Data

The 45MG optional datalogger is a file-based system, in which one file is opened at a time. The active file stores a measurement at a thickness-measurement location ID. Each time you press **[SAVE]**, the displayed value is saved to the active file at the current ID. The ID is automatically incremented for the next measurement. When you press **[FILE]**, the name of the active file appears in the ID bar above the menu (see Figure 5-13 on page 75).

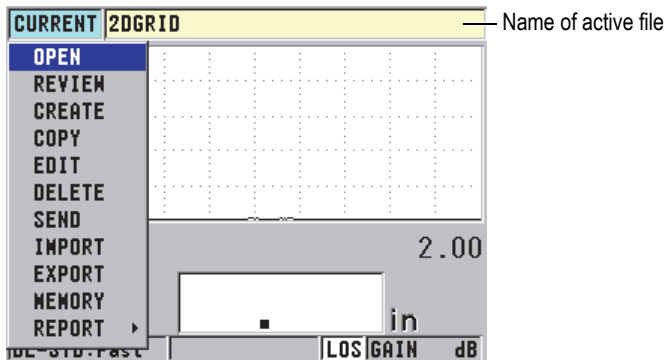

Figure 5-13 The active file name appearing in the ID bar

The NONAME00 increment-type file, starting with the 001 ID, is the active file by default when you first use the 45MG, or after resetting the instrument memory. Various types of files can be created, and IDs can be defined to represent various 1-D, 2-D, or 3-D thickness-measurement locations. When the instrument is restarted, it automatically opens the last file used.

The following special cases may occur:

- When the thickness value is blank, “— — —” is saved rather than a value.
- When a measurement is already stored at the current ID, the new value overwrites the old thickness reading unless the overwrite protection is enabled (see “Setting the ID Overwrite Protection” on page 125).
- When the ID increment reaches the end of a sequence and cannot be updated, **Last ID** appears on the help text bar, a long beep sound is emitted (when the beeper is active), and the ID on the display remains unchanged.

Refer to “Datalogger Option” on page 98 for more information on the datalogger.

To save data at the current ID in the active file

- ◆ While the desired thickness value and waveform are displayed, press [SAVE] to save the measured thickness value.

OR

To save the measured thickness value and the waveform, set the **SAVE KEY DATA** to **THICKNESS + WF** in the **SYSTEM** menu (see Figure 4-1 on page 54).

6. Software Options

The available software options can be used to increase the capability of the already versatile 45MG (see Table 2 on page 77).

Table 2 45MG software options

Option	Part number	Description
Echo-to-Echo & THRU-COAT	45MG-EETC (U8147021)	Enables the 45MG to make measurements in Echo-to-Echo and THRU-COAT modes. These features are used to measure the remaining metal thickness when the material is painted/coated. Note: Manual Echo-to-Echo is only available when the Waveform option is also purchased.
Datalogger Capability	45MG-DL (U8147020)	Adds a bidirectional alphanumeric file-based datalogger. This option also includes a USB communication cable and the GaugeView interface program.
Waveform	45MG-WF (U8147019)	Provides the added capability of viewing the live A-scan of the ultrasonic signal.

Table 2 45MG software options (continued)

Option	Part number	Description
Single Element including High Resolution (see “Measurements with Optional THRU-COAT, D7906, and D7908 Transducers” on page 86)	45MG-SE (U8147022)	Enables the 45MG to use single element transducers. With this option, the user can recall default single element transducers, and also create and store custom single element transducer setups. This feature also increases the thickness resolution to either 0.001 mm or 0.0001 in. for single element transducers with a frequency ≥ 2.25 MHz.
High Penetration with Single Element (see “High-Penetration Software Option” on page 98)	45MG-HP (U8147023)	Enables the 45MG to use low-frequency single element transducers (as low as 0.5 MHz) for thickness measurements in attenuating and sound scattering materials.

When you order a software option with your original 45MG purchase, the option comes preactivated. Software options can also be purchased at a later date. The software options can be activated by entering an activation code in the instrument, without the need to return the instrument to the factory. (see “Activating Software Options” on page 78).

Contact your local Evident representative for more information about ordering software options. Refer to Table 2 on page 77 for the software-option part numbers.

6.1 Activating Software Options

Each 45MG has a unique serial number code. A provided option key specific to a particular 45MG activates the purchased software options only on that specific 45MG unit. A single-option key is capable of activating one, several, or all software options.

To activate a software option

1. In the measurement screen, press **[SETUP]**, and then select **SP MENU**.
2. In the **SP MENU** (see Figure 4-2 on page 55), select **OPTIONS** (see Figure 6-1 on page 79), take note of the 16-digit alphanumeric serial number appearing in the **E-S/N** field.

The **OPTION** list indicates the actual status of the software options, where the check mark (✓) indicates that the option is activated.

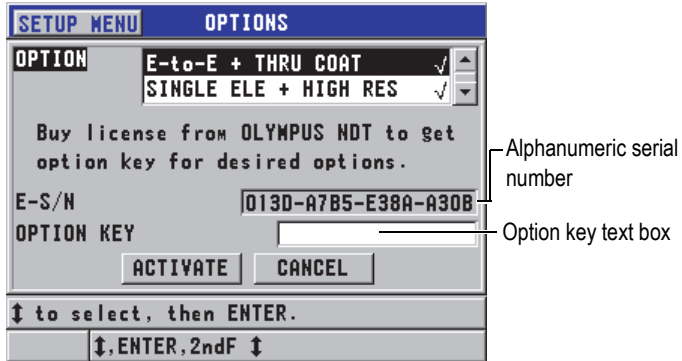

Figure 6-1 The **OPTIONS** screen

3. To purchase one or more software options, contact your local Evident representative and provide the alphanumeric serial number (**E-S/N**). Your Evident representative will provide you with the corresponding option key.
4. In the **OPTIONS** screen (see Figure 6-1 on page 79):
 - a) Enter the option key in the **OPTION KEY** text box provided to you from the Evident representative.
 - b) Select **ACTIVATE**.
5. Restart the instrument to complete the activation.

6.2 Echo Detection Modes with Dual Element Transducers

With dual element transducers, the 45MG offers three echo detection modes that allow you to measure thicknesses in various material conditions. A description of each of the three echo detection modes (**STANDARD**, optional **AUTO E-TO-E**, and **MANUAL E-TO-E**) follows:

STANDARD

The standard echo detection mode measures the thickness based on the time of flight between the main bang and the first back-wall echo. Use this mode for uncoated materials.

The **DE-STD** indicator appears to the left of the thickness reading, and a triangular echo detection marker appears at the back-wall echo, below the waveform display (see Figure 6-2 on page 80).

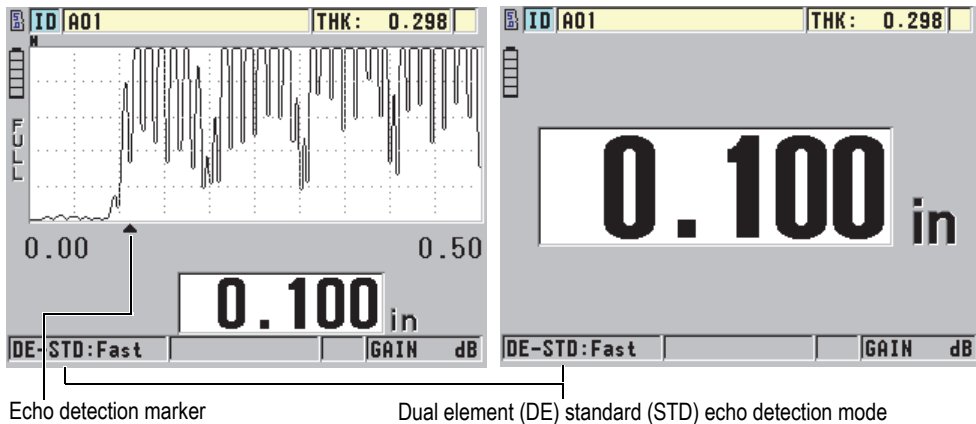

Figure 6-2 Measuring with the standard echo detection mode

AUTO E-TO-E (Optional)

The automatic Echo-to-Echo detection mode measures the thickness using the time of flight between two consecutive back-wall echoes. Use this mode for painted or coated materials, because the time interval between consecutive back-wall echoes excludes the time of flight through a paint, resin, or coating layer.

The **DE-AEtoE** indicator appears to the left of the thickness reading.

When the Waveform software option is enabled, the triangular marker is replaced by an Echo-to-Echo detection bar that indicates the exact pair of back-wall echoes used to determine the thickness (see Figure 6-3 on page 81). The echo height is automatically adjusted to a preset level.

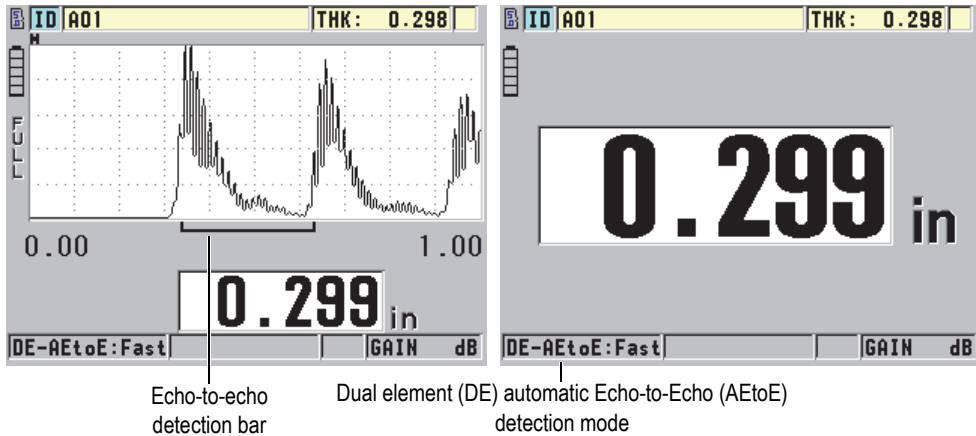

Figure 6-3 Measuring with the automatic Echo-to-Echo detection mode

MANUAL E-TO-E (optional and only available when Echo-to-Echo and the Waveform options are activated)

The manual Echo-to-Echo detection mode also measures the thickness using the time of flight between two consecutive back-wall echoes. However, the gain and blanking parameters can also be manually adjusted in this mode. This mode is useful when material conditions produce noisy signals that could render the automatic mode less effective.

The **DE-MEtoE** indicator appears to the left of the thickness reading. The Echo-to-Echo detection bar is similar to the automatic Echo-to-Echo mode, but includes the adjustable E1 blank bar that indicates the area to exclude for echo detection (see Figure 6-4 on page 82). Following the E1 blank, the instrument detects the next echo with an amplitude of at least 20 % of the waveform display height. In this mode, press **[GAIN/WAVE ADJ]**, and then use the arrow keys to adjust the **EXT BLANK**, the **E1 BLANK**, and the **GAIN** parameters.

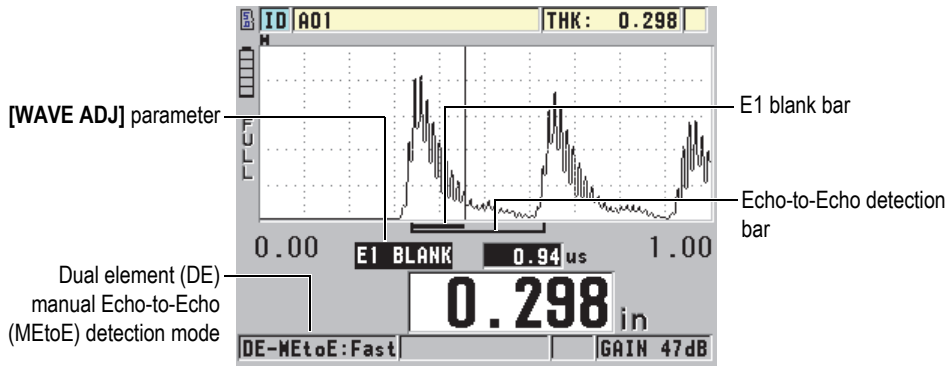

Figure 6-4 Measuring with the manual Echo-to-Echo detection mode

NOTE

In severe corrosion situations where valid multiple echoes are not present, you must use either the standard or optional THRU-COAT mode in order to be able to measure thicknesses.

Dual element transducers can be used in all three modes, and all measurement, display, and datalogger functions can be used with the echo-to-echo modes. The internal datalogger recognizes all necessary echo-to-echo information, and saves it in order to upload and download thickness, waveform, and setup data.

TIP

It is not necessary to switch between echo detection modes when measuring both coated and uncoated areas, because it is possible to measure uncoated wall thicknesses using an echo-to-echo mode.

To change the echo detection mode

1. In the measurement screen, press **[SETUP]**, and then select **MEAS**.

2. In the **MEAS** screen, set the **MEAS MODE** to the desired echo detection mode: **STANDARD**, **AUTO E-TO-E** (optional), or **MANUAL E-TO-E** (only available with the Waveform option).

NOTE

When switching between standard and Echo-to-Echo modes, it may be necessary to perform a second **[CAL ZERO]**, because the zero offset is different for each measurement mode. The 45MG can store two different zero calibrations, one for standard mode, and the other for Echo-to-Echo mode.

3. To perform the zero calibration again:
 - a) Place a drop of couplant on the surface of the thin part of the test block.
 - b) Couple the transducer to the thin part of the test block, and then press **[CAL ZERO]**.
 - c) Once the thickness reading is stable, press **[ENTER]**.
 - d) Using the arrow keys, edit the thickness value to match the known thickness of the thin part of the test block.

6.2.1 Blanking Adjustments in Manual Echo-to-Echo Detection Mode

The 45MG offers two blanking functions to help detect valid echoes in situations where material conditions generate unwanted signals:

EXT BLANK

The extended blank creates a blanked zone that begins at the left edge of the waveform display, and in which no signals are detected. In situations where the second or third pair of back-wall echoes are stronger or cleaner than the first pair, use the extended blank to control which pair of echoes are used for measurement.

E1 BLANK

The echo 1 (E1) blank runs for a selected interval following the first detected echo. Use the E1 blank to exclude any unwanted peaks occurring between the first and second back-wall echoes. Unwanted peaks may be trailing edges of a large first echo, or shear-wave reflections on thick test pieces. The E1 blank parameter is only available in the manual Echo-to-Echo detection mode.

To adjust the extended and the E1 blank parameters

1. Select the manual Echo-to-Echo mode:

- a) In the measurement screen, press [SETUP], and then select **MEAS**.
 - b) In the **MEAS** menu, set the **MEAS OPTION** to **MANUAL E-TO-E**, and then press [MEAS].
2. Press [GAIN/WAVE ADJ].
- The wave adjustment parameter appears (see Figure 6-5 on page 84).

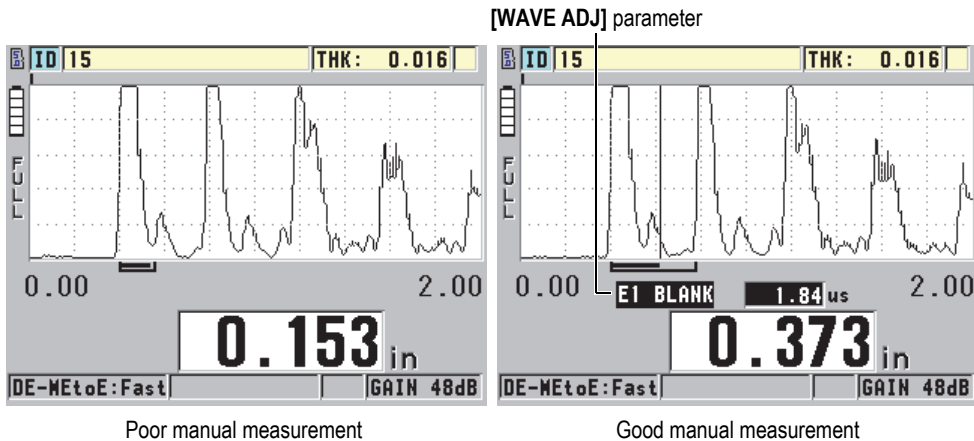

Figure 6-5 Comparing manual measurements

3. Use the [▲] and [▼] keys to select either the **EXT BLANK** or the **E1 BLANK** parameter.
4. Use the [▶] and [◀] keys to adjust the value to exclude unwanted peaks and to detect the desired echoes.

6.2.2 Dual Element Transducer Selection in Echo-to-Echo Modes

Although the optional Echo-to-Echo modes work with all the 45MG dual element transducers, Evident recommends using specific transducers for particular thickness ranges in steel parts (see Table 3 on page 84).

Table 3 Recommended transducers for various steel thickness ranges

Transducer type	Thickness range ^a
D798	1.5 mm to 7.6 mm (0.060 in. to 0.300 in.)

Table 3 Recommended transducers for various steel thickness ranges (continued)

Transducer type	Thickness range ^a
D790/791	2.5 mm to 51 mm (0.100 in. to 2.00 in.)
D797	12.7 mm to 127 mm (0.500 in. to 5.00 in.)
D7906	2.5 mm to 51 mm (0.100 in. to 2.00 in.)

- a. Thickness ranges are dependent on the transducer type, material conditions, and temperature.

In some cases, an error can occur if you are using a D790 transducer to measure thicknesses above 18 mm (0.7 in.). Typically, this error is due to a mode-converted shear-wave echo that may appear before the second back-wall echo. If this unwanted echo is larger than the second back-wall echo, the gauge measures the distance to it, which produces a thinner reading.

You can usually distinguish the unwanted shear-wave echo from the correct back-wall echo by examining the waveform display. The distance between the first and the second back-wall echoes is the same as the distance between the zero thickness point and the first back-wall echo. If there is an echo between the first two back-wall echoes, it is probably a mode-converted shear-wave echo. Use the manual echo-to-echo detection mode techniques, and manually adjust the E1 blank to eliminate this error (see “Blanking Adjustments in Manual Echo-to-Echo Detection Mode” on page 83). Using the D797 transducer beyond 18 mm (0.7 in.) helps eliminate the possibility of this error.

In some cases, the second or third back-wall echo is smaller in amplitude than subsequent echoes, which causes the instrument to give a double or triple reading. If you are using a D790 transducer, this effect may occur around 5 mm (0.2 in.) on flat, smooth steel samples. If this occurs, it is clearly visible on the waveform display, and you can work around it using the manual echo-to-echo detection mode, or by moving the extended blank beyond the previously detected first echo.

When the 45MG cannot make an echo-to-echo reading, the **LOS** flag appears on the screen. In this case, the waveform display shows that either no echoes are large enough to be detected, or that only one echo is detectable. In the latter case, the Echo-to-Echo detection bar begins at the detected echo, but extends indefinitely to the right. Increase the gain value to make a good echo-to-echo reading. If this does not help, you can still obtain an approximate measurement by returning to the standard echo detection mode.

6.3 Measurements with Optional THRU-COAT, D7906, and D7908 Transducers

THRU-COAT is an optional function that measures the true metal thickness of coated or painted parts. This function only requires a single back-wall echo, and is recommended for heavy corrosion applications where the outside of the material is coated or painted. If necessary, the measurement of the coating/paint layer can also be calibrated to precisely measure the thickness of the coating/paint.

NOTE

In order for the THRU-COAT function to work properly, the thickness of the coating or paint must be at least 0.125 mm (0.005 in.) thick. The maximum coating/paint thickness that THRU-COAT can measure is dependent on the type of coating, but typically greater than 2 mm (0.080 in.).

If the THRU-COAT function does not display a coating thickness, or if the coating thickness does not seem realistic, THRU-COAT may not be able to properly resolve the coating thickness. In such cases, the user should try a different measurement mode, like Echo-to-Echo or standard.

6.3.1 Enabling the THRU-COAT Function

The THRU-COAT function is only available when you connect a THRU-COAT transducer (P/N: D7906 [U8450005] or D7908 [U8450008]) to the 45MG.

To enable the THRU-COAT function

1. Connect a THRU-COAT transducer to the 45MG.
2. Turn on the instrument.
3. Wipe the couplant off the transducer tip.
4. Press **[2nd F]**, **[CAL ZERO]** (**Do ZERO**) (see Figure 6-6 on page 87).

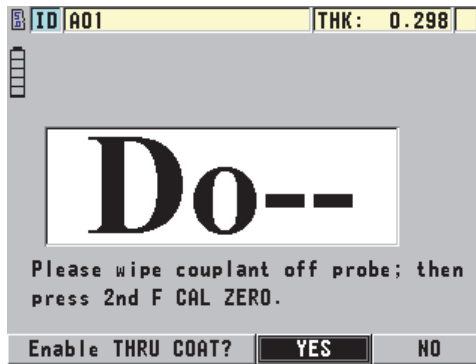

Figure 6-6 Opening the THRU-COAT setup dialog box

5. Select **YES** to answer the **Enable THRU COAT?** prompt.

6.3.2 Performing a THRU-COAT Calibration

The calibration procedure for a THRU-COAT probe is similar to the procedure for other probes. As for a normal calibration, you need two uncoated samples with accurately known thin and thick thicknesses in order to perform the calibration procedure below. The difference is that towards the end of the procedure, you can press **[CAL VEL]** a second time to calibrate the coating thickness measurement on a sample with an accurately known coating thickness.

To perform a THRU-COAT calibration

1. Ensure that the THRU-COAT function is enabled (see “Enabling the THRU-COAT Function” on page 86).
2. Couple the transducer to the thick sample.
3. Press **[CAL VEL]**.
4. Once the reading is stable, press **[ENTER]**.
5. Using the arrow keys, edit the thickness value to match the known thickness of the sample.
6. Couple the transducer to the thin sample.
7. Press **[CAL ZERO]**.
8. Once the reading is stable, press **[ENTER]**.

9. Using the arrow keys, edit the thickness value to match the known thickness of the sample.
10. If the coating thickness-measurement accuracy is important to your application, perform the following actions (omitting this step does not affect the accuracy of the metal thickness measurement):
 - a) Press **[CAL VEL]** again.
 - b) Couple the transducer to the coated sample.
 - c) Once the reading is stable, press **[ENTER]**.
 - d) Using the arrow keys, edit the thickness value to match the known coating thickness of the coated sample.
11. Press **[MEAS]** to complete the calibration.

NOTE

Pressing **[2nd F]**, **[CAL VEL]** (**VEL**) opens the **VELOCITY** screen, in which you can see and edit the calibrated metal sound velocity. Pressing **[2nd F]**, **[CAL VEL]** (**VEL**) again opens the **VELOCITY** screen for the calibrated sound velocity through the coating.

6.4 Waveform Software Option

The live Waveform option for the 45MG allows the user to view the live ultrasonic waveform in order to aid alignment of the transducer during difficult applications. When this option is activated, the user can switch between the standard thickness display (see Figure 6-7 on page 89) and the optional waveform thickness display (see Figure 6-8 on page 90).

Other waveform setup features are listed below:

- **[GAIN/WAVE ADJ]** allows the user to make setup adjustments that are not available in standard mode.
 - With dual element transducers (see “Using Advanced Gaging Features” on page 157):
 - Manually adjust the **GAIN** in 1 dB increments.
 - Set an extended blank.
 - Set an Echo1 blank in Manual Echo-to-Echo mode.

- Adjust the waveform range and delay.
- With the Single Element transducer option (see “Custom Setups for Single Element Transducers” on page 173):
 - Adjust the pulse-receive parameters (TVG gain and blanks)
 - Create custom single element transducer setups.
 - Adjust the waveform range and delay.
- Auto Zoom: This mode automatically adjusts the range and delay so that the measured echo is always on-screen.
- The waveform rectification: Enables the user to switch the waveform between Full wave, Half+, Half-, and RF display.
- Waveform Fill: Enables the user to show the filled-in waveform. This feature is not available for RF rectification mode.
- Assigns the [SAVE] key to:
 - Save only the thickness value.
 - OR
 - Save the thickness and waveform (only available when the Datalogger software option is also purchased).

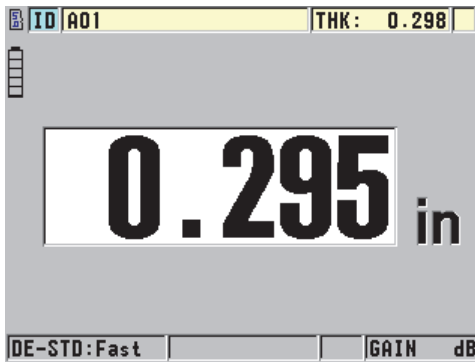

Figure 6-7 Standard display

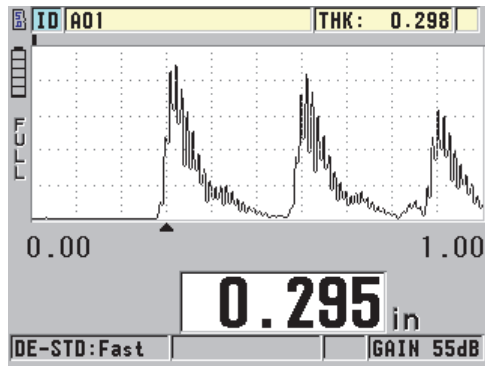

Figure 6-8 Waveform display

To activate the waveform

1. In the measurement screen, press [SETUP], and then select **DISPLAY**.
2. Set **WAVEFORM ENABLE** to **ON**.

6.4.1 Waveform Rectification

The rectification mode determines the way in which the ultrasonic echoes are represented on the waveform display (see Figure 6-9 on page 91). The rectification mode does not affect the thickness measurement in any way. The rectification indicator (**FULL**, **POS**, **NEG**, or **RF**) appears on the left edge of the waveform display. In the measurement screen, press [SETUP], and then select **DISPLAY** to access the **WAVEFORM RECTIFICATION** parameter.

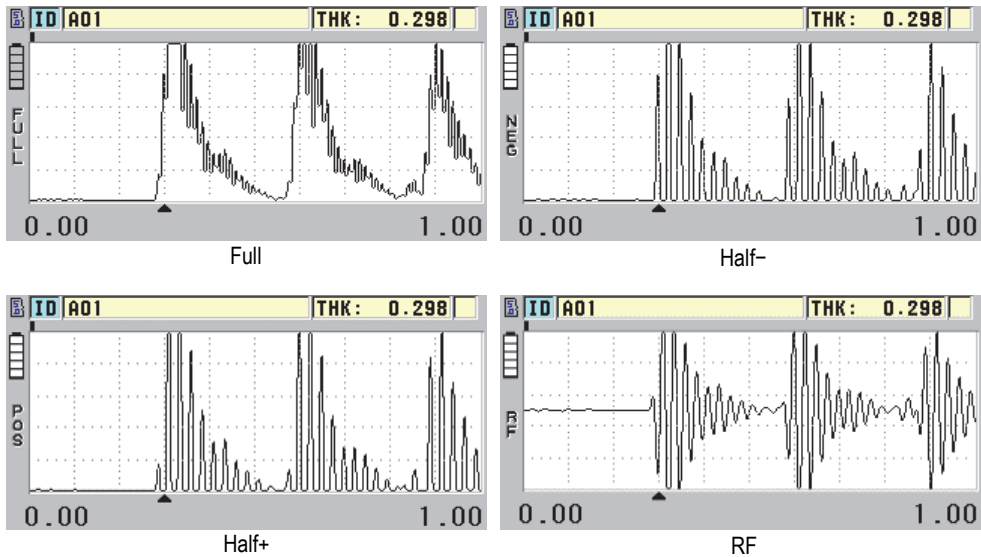

Figure 6-9 Examples of the rectification modes

The available rectification modes are:

FULL

This mode shows the negative portion of the echo folded around the baseline, so that both positive and negative waveform lobes are displayed. This mode provides the best overall representation of position and magnitude for most thickness-measurement applications. **FULL** is the default mode for dual element transducers.

HALF- (NEG indicator)

This mode shows negative waveform lobes as positive, and does not show the positive lobes.

HALF+ (POS indicator)

This mode shows positive waveform lobes, and does not show the negative waveform lobes.

RF

This mode shows negative and positive lobes on either side of the baseline. **RF** is the default mode for single element transducers.

6.4.2 Waveform Trace

The 45MG can display the waveform trace as a line (**OUTLINE**), or as a **FILLED** area (see Figure 6-10 on page 92). In the measurement screen, press **[SETUP]**, and then select **DISPLAY** to access the **WAVEFORM TRACE** parameter.

NOTE

A filled-in waveform trace is only possible when the waveform rectification is set to **FULL**, **HALF+**, or **HALF-**.

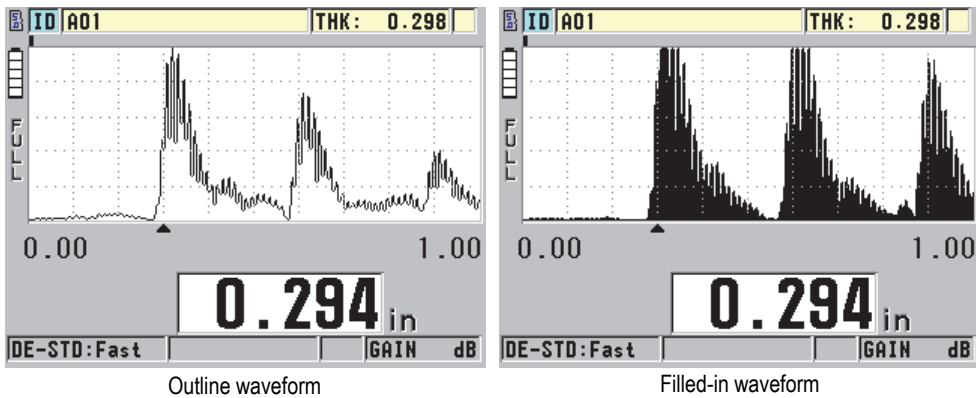

Figure 6-10 Examples of waveform trace modes

6.4.3 Range of the Waveform Display

The range of the waveform display (see Figure 6-11 on page 93) is the distance spanned by the horizontal axis of the waveform display. The left end of the horizontal axis, the delay, is generally set to zero. The delay value can be manually adjusted to change the starting point of the range (see “Adjusting the Delay Value” on page 94), and to select the end point of the range (see “Selecting the Range Value” on page 93). You can also activate the zoom function to automatically set the delay and the range values for optimum visualization of the echo (see “Activating the Zoom Function (Available Only with the Waveform Option)” on page 94).

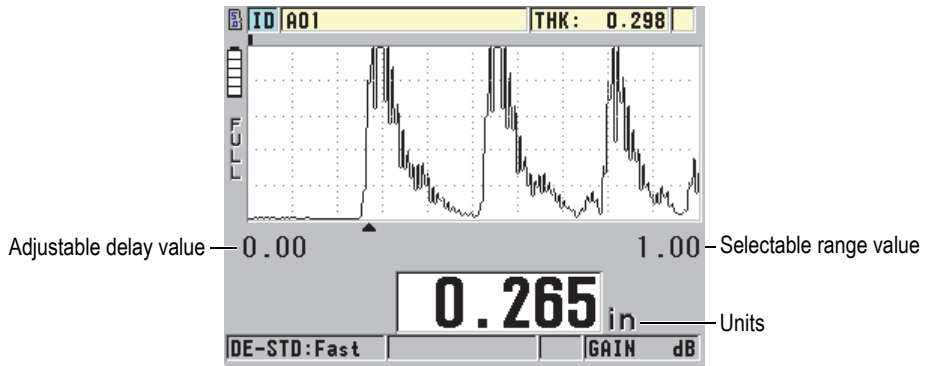

Figure 6-11 The range of the waveform display

6.4.3.1 Selecting the Range Value

There are fixed ranges available for each transducer frequency. The available ranges are also dependent on material sound velocity. These selectable ranges let you adjust the thickness span of the waveform display to show only the thickness range being measured, and thus obtain maximum waveform resolution for each application. The range setting affects only the waveform display. It is possible to make measurements even when the display range does not show the detected echo from which the thickness is measured. The range cannot be manually set while the zoom is active.

To select the range value

1. In the measurement screen, press the [▲] and [▼] keys to adjust the range. The waveform range changes to the next higher available range.
2. Continue pressing the [▲] key to select the next higher range, or press the [▼] key to select the next lower range.
3. The range value recycles to the minimum range value following the maximum value.

NOTE

When the [GAIN/WAVE ADJ] parameters are active, the range and delay become items in the parameter list. Use the [▲] and [▼] keys to highlight the range parameter, and the [▶] and [◀] keys to adjust the range. Press [MEAS] to stop adjusting the range.

6.4.3.2 Adjusting the Delay Value

The delay of the waveform display adjusts the beginning of the horizontal span. The delay can be adjusted to display the waveform of interest in the center of the waveform display. This function is very useful when using delay line or immersion transducers, or when measuring thick material, in order to ensure that the measured echoes can be seen in greater detail.

To adjust the delay value

- ◆ In the measurement screen, press the [▶] and [◀] keys to adjust the delay.
-

NOTE

When the [GAIN/WAVE ADJ] parameters are active, the range and delay become items in the parameter list. Use the [▲] and [▼] keys to highlight the delay parameter, and the [▶] and [◀] keys to adjust the delay. Press [MEAS] to stop adjusting the delay.

6.4.3.3 Activating the Zoom Function (Available Only with the Waveform Option)

The zoom function automatically and dynamically sets the delay and range values to optimally track and show the detected echo in the waveform display.

To activate the zoom function

1. In the measurement screen, press [SETUP], and then select **DISPLAY**.
2. In the **DISPLAY** screen, set the **ZOOM OPTION** to **ON**.

The zoom flag (**Z**) appears on the lower right side of the waveform display, below the range parameter.

The resulting zoomed waveform depends on the current measurement mode. The zoom for D79X dual element transducers and mode 1 single element transducers centers the first back-wall echo on the screen (see Figure 6-12 on page 95).

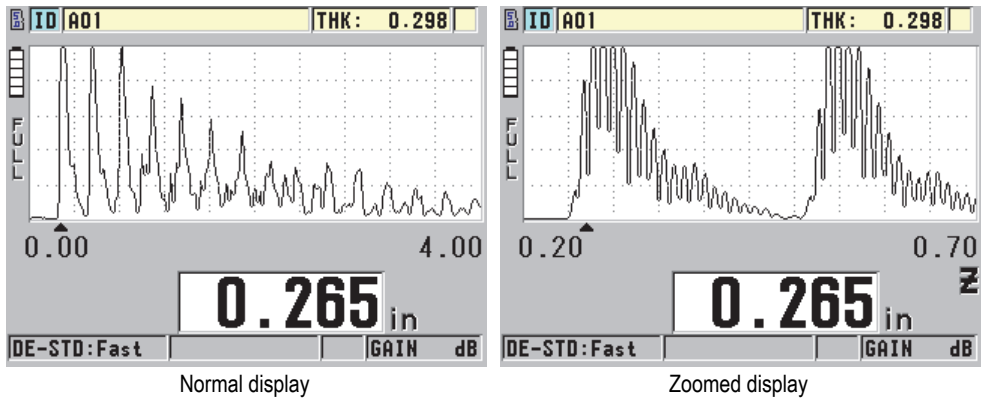

Figure 6-12 Comparing the normal and zoomed display in mode 1

The zoom with single element transducers in mode 2 adjusts the waveform range and delay so that the interface echo and the first back-wall echo appear on the waveform display (see Figure 6-13 on page 95).

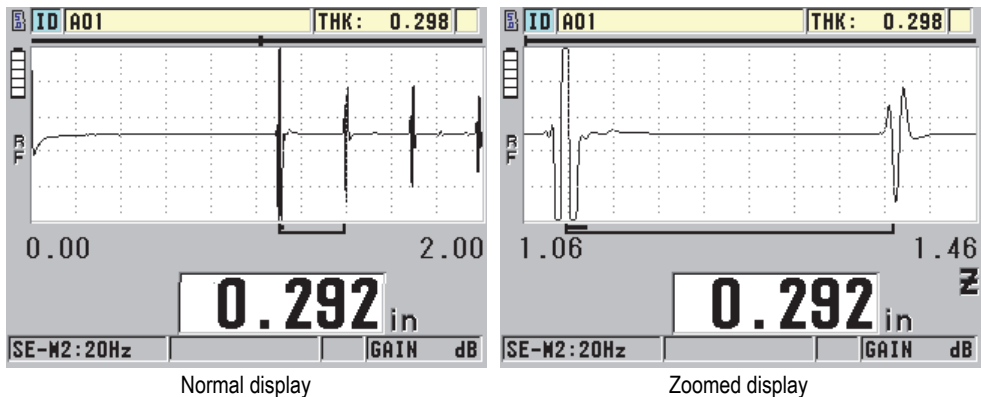

Figure 6-13 Comparing the normal and zoomed display in mode 2

The zoom with single element transducers in mode 3 adjusts the waveform range and delay so that the interface echo and the second measured back-wall echo appear on the waveform display (see Figure 6-14 on page 96).

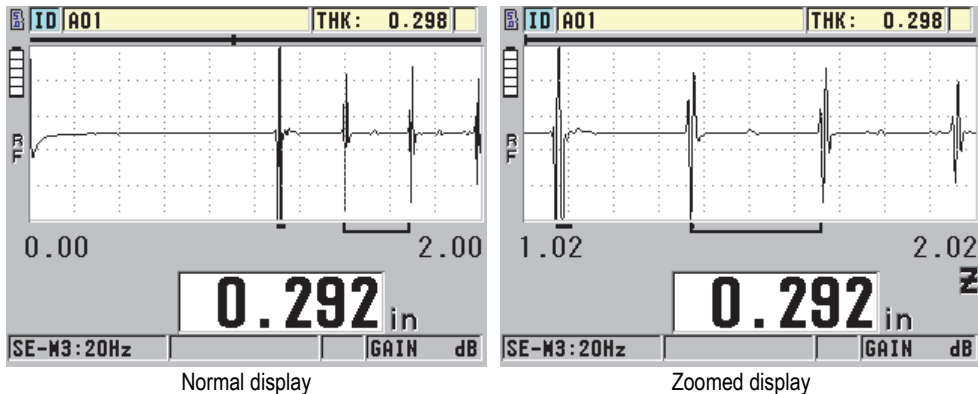

Figure 6-14 Comparing the normal and zoomed display in mode 3

To deactivate the zoom function

1. In the measurement screen, press [SETUP], and then select **DISPLAY**.
2. In the **DISPLAY** screen, set the **ZOOM OPTION** to **OFF**.

6.5 Single Element and High Resolution Option

The optional Single Element High Resolution software allows the 45MG to use single element direct contact, delay line, and immersion transducers. This enables the 45MG to be used for precision thickness gaging applications. When this option is activated, the user can select from a set of default single element transducer setups, or create and store/recall customers' single element setups.

The 45MG is not able to automatically recognize which single element transducer is connected. As such, the appropriate default or customer setup must be recalled for the single element transducer being used.

6.5.1 Recalling Single Element Transducer Setups

The procedure for recalling single element transducer setups is explained in “Setting Up the Transducer” on page 61.

6.5.2 Creating Custom Single Element Transducer Setups

For more information about how to create custom single element transducer setups, please refer to “Custom Setups for Single Element Transducers” on page 173.

6.5.3 High-Resolution Thickness

The 45MG has the ability to display thickness values with its standard resolution of 0.01 mm (or 0.001 in.), and its low resolution of 0.1 mm (or 0.01 in.). These resolutions are adequate for most ultrasonic thickness-measurement applications.

For single element transducers, the high-resolution software option provides the added ability to display thickness readings with a high resolution of 0.001 mm (or 0.0001 in.). High resolution is not available for all transducers and measurement modes, and is also limited to the maximum thickness. Although the 45MG is able to display thickness readings in high resolution, the measurement accuracy is highly dependent on the material, geometry, surface condition, and temperature, and also needs to be determined on a case-by-case sample evaluation basis.

High resolution is available for the following transducers and measurement conditions:

- Single element transducer in the frequency range of 2.25 MHz to 30.0 MHz
- Thickness measurement below 100 mm (or 4.00 in.)

High resolution is not available for the following transducers or measurement conditions:

- Dual element transducers
- Low-frequency transducers with a frequency below 2.25 MHz
- Thickness ranges over 100 mm (or 4.00 in.)
- Once activated, the high-resolution selection appears in the resolution selection list (see “Changing the Thickness Resolution” on page 60).

6.6 High-Penetration Software Option

The 45MG high-penetration software option coupled with low-frequency single element transducers (down to 0.5 MHz) allows you to make thickness, material sound velocity, and time-of-flight measurements on materials such as composites, fiberglass, plastic, rubber, and cast metals that are difficult or impossible to measure using standard ultrasonic instruments. The M2008 [U8415001] transducer is a special low-frequency transducer used to measure the thickness of thick fiber-reinforced polymer (FRP) and composite materials.

NOTE

With a M2008 transducer only, press **[2nd F], [CAL ZERO] (Do ZERO)** at any time to auto-adjust the zero offset and compensate for temperature changes in the delay line.

To use the high-penetration software option with the M2008 transducer

1. Ensure that the high-penetration software option is activated (see “Activating Software Options” on page 78 for details).
2. Connect the M2008 transducer to the T/R 1 connector at the top of the 45MG.
3. Press **[2nd F], [FREEZE] (XDCR RECALL)**.
4. In the menu, select **DEFAULT HP SINGLE ELEMENT**.
5. In the **DEFAULT HP SINGLE ELEMENT** screen, highlight the default transducer setup for the M2008 (**DEFP1-0.5-M2008**), or any custom setup that uses the M2008 transducer.
6. Press **[MEAS]** to return to the measurement screen with the recalled transducer setup.
7. Wipe the couplant off the transducer tip.
8. Press **[2nd F], [CAL ZERO] (Do ZERO)**.
9. Perform the material sound velocity and zero calibration (see “Calibrating the Instrument” on page 65).

6.7 Datalogger Option

This section describes how to use the 45MG internal datalogger to organize your data.

6.7.1 Datalogger

The 45MG datalogger is a file-based system, in which one file is opened at a time. The active file stores a measurement at a thickness-measurement location ID. Each time you press [SAVE], the displayed value is saved to the active file at the current ID. The ID is automatically incremented for the next measurement. When you press [FILE], the name of the active file appears in the ID bar above the menu (see Figure 6-15 on page 99).

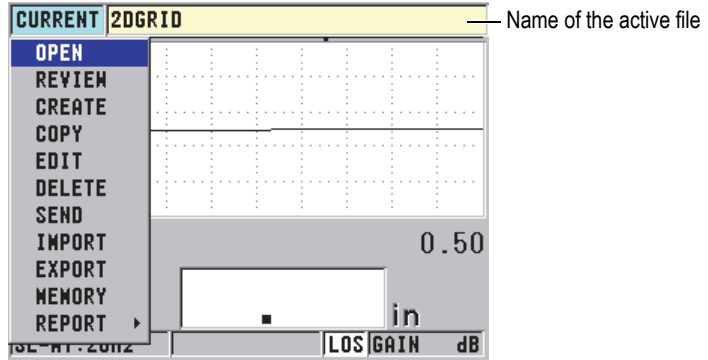

Figure 6-15 The active file name appears in the ID bar

The file also contains header parameters that can be defined to better describe the content of the file. In the file, you can organize the ID range, select the data format, and select the saved data. Table 4 on page 99 summarizes the contents of a file, and indicates where you can find more information.

Table 4 File contents summary

Contents	Description	See section
Header	Extra parameters to describe the contents and the context of the data	“Creating a Data File” on page 101

Table 4 File contents summary (continued)

Contents	Description	See section
Measurement data	Organized by predefined IDs arranged by file types	“Data File Types” on page 103
	Data format defined by the file data mode	“File Data Modes” on page 114
	Saved data (thickness measurement with or without the waveform) configured using the setup menu	“Saving Data” on page 75

You can identify the datalogger parameters in the ID bar at the top of the measurement screen (see Figure 6-16 on page 100).

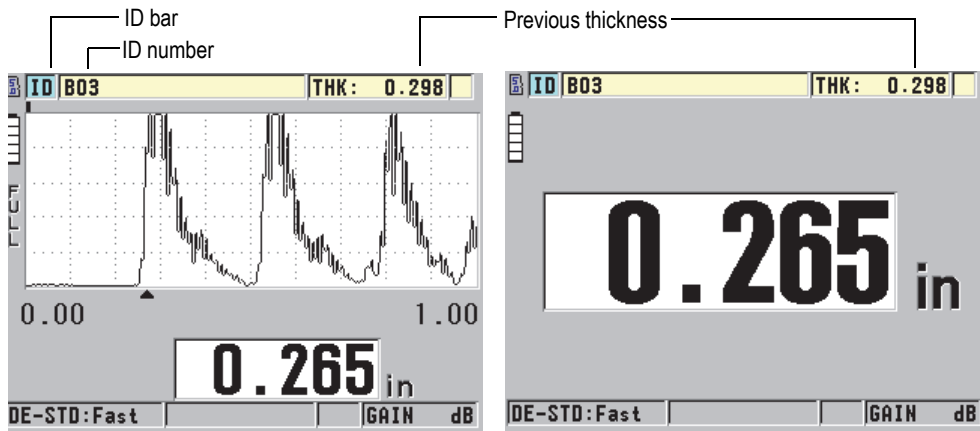
**Figure 6-16 Identifying datalogger parameters**

With each measurement, the 45MG also stores a complete description of the measurement conditions. Table 5 on page 101 describes the additional data stored with each thickness measurement and with each waveform.

Table 5 Additional information stored with the data

For a measurement	For a waveform
File name	Zoom status
File header data	Horizontal axis limits
Identifier	Detection marker position
Units (mm or in.)	Delay
LOS (loss of signal)	Range
Differential mode	Rectification mode
Differential reference value	
Alarm mode	
Alarm status	
Alarm set points	
Minimum or maximum mode	
Minimum or maximum reading	
Velocity	
Resolution	
Transducer setup number and information	
Coating thickness (when THRU-COAT is active)	

It is possible to store approximately 475000 thickness values without waveforms in the internal memory, or approximately 20000 thickness values with waveforms. You can double the storage capacity by using an optional external microSD memory card. The maximum capacity of the external microSD card that can be used on the 45MG is 2 GB.

With the datalogger, you can easily create a data file (see “Creating a Data File” on page 101), perform a number of file operations (see “Performing File Operations” on page 115), and perform data operations (see “Setting the ID Overwrite Protection” on page 125).

6.7.2 Creating a Data File

The following procedure describes how to create a data file in the 45MG.

NOTE

It is also possible to create a 45MG data file from a computer using the GaugeView interface program. Refer to the *GageView Interface Program – User’s Manual* (P/N: 910-259-EN [U8778347]) for details.

To create a data file

1. In the measurement screen, press **[FILE]**, and then select **CREATE**.
2. In the **CREATE** screen (see Figure 6-17 on page 103):
 - a) In the **FILE NAME** parameter, enter the desired file name using up to 32 characters.
 - b) In the **DESCRIPTION** parameter, optionally enter a description of the contents of the file.
 - c) In the **INSPECTOR ID**, optionally enter an identification of the inspector.
 - d) In the **LOCATION NOTE** parameter, optionally enter an identification of where the measurements are performed.
 - e) Select the appropriate data **FILE TYPE** for your application (see “Data File Types” on page 103 for details).
 - f) Select the appropriate **FILE DATA MODE** for your application (see “File Data Modes” on page 114 for details).
 - g) Set the **DELETE PROTECTION** mode to **ON** or **OFF**.
Delete protection locks the file so it cannot be deleted. You can unlock the file for deletion using the file edit function.
 - h) Depending on the selected **FILE TYPE**, refer to the following sections for the remaining steps of this procedure:
 - **INCREMENTAL** see “Incremental Data File Type” on page 103
 - **SEQUENTIAL** see “Sequential Data File Type” on page 106
 - **SEQ+CUSTOM PT** see “Sequential with Custom Point Data File Type” on page 107
 - **2D GRID** see “2-D Grid Data File Type” on page 108

- **BOILER** see “Boiler Data File Type” on page 112



Figure 6-17 Example of the CREATE screen

TIP

At any time, you can press [2nd F], [▲] or [2nd F], [▼] to scroll between parameters on the screen.

6.7.2.1 Data File Types

You can create a data file using one of the following five data file types:

- Incremental
- Sequential
- Sequential with Custom Point
- 2-D Matrix Grid
- Boiler

6.7.2.2 Incremental Data File Type

The incremental data file type uses the alphanumeric start ID value (up to 20 characters), and automatically increments to the subsequent ID value using the following incrementation rules:

- Increments only digits and letters, not punctuation marks or other special characters.
- Begins incrementation with the right-most character.
- Extends leftward until reaching the first punctuation mark or special character, or the left-most character, whichever comes first.
- Increments digits from 0, 1, 2,..., 9. Makes the 9 to 0 transition only after incrementing the character to the left.
- Increments letters from A, B, C,..., Z. Makes the Z to A transition only after incrementing the character to the left.
- When an ID cannot be incremented after a reading is saved, the **Cannot increment ID!** message momentarily appears in the help text bar. Subsequent saves overwrite the reading of the last possible ID until the ID value range is changed.

NOTE

To configure the gauge to increment through a range of numbers several digits wide while beginning with a single-digit ID number, the maximum number of digit positions must be entered initially using leading zeros (see examples in Table 6 on page 104).

Table 6 Resulting ID examples for the INCREMENTAL file type

START ID	Resulting IDs	
1	1, 2, 3,..., 9	
0001	0001 0002 0003 ... 0009	0010 ... 9999
ABC	ABC ABD ABE ... ABZ	ACA ACB ACC ... ZZZ

Table 6 Resulting ID examples for the INCREMENTAL file type (continued)

START ID	Resulting IDs
1A	1A 1B 1C ... 1Z
ABC*12*34	ABC*12*34 ABC*12*35 ABC*12*36 ... ABC*12*99

To create an incremental data file

1. In the measurement screen, press **[FILE]**, and then select **CREATE** (see “Creating a Data File” on page 101 for details on the first parameters).
2. In the **CREATE** screen (see Figure 6-18 on page 105):
 - a) Enter the **START ID** value.
 - b) Select **CREATE**.

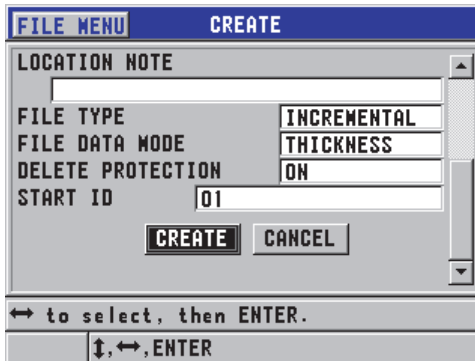
**Figure 6-18 The CREATE screen for the incremental data file type**

6.7.2.3 Sequential Data File Type

The sequential data file type is similar to the incremental type, although it also allows you to define both starting and ending ID numbers. The resulting file is inclusive of the starting and ending points, and all incremental points in between (see the examples in Table 7 on page 106).

Table 7 Resulting ID examples for the SEQUENTIAL file type

START ID	END ID	Resulting IDs
ABC123	ABC135	ABC123 ABC124 ABC125 ... ABC135
XY-GY	XY-IB	XY-GY XY-GZ XY-HA ... XY-IB

To create a sequential data file

1. In the measurement screen, press **[FILE]**, and then select **CREATE** (see “Creating a Data File” on page 101 for details on the first parameters).
2. At the bottom of the **CREATE** screen, select **CONTINUE**.
3. In the second page of the **CREATE** screen (see Figure 6-19 on page 107):
 - a) Enter the **START ID** and **END ID** values.
 - b) Select **CREATE**.

Figure 6-19 Selecting the ID range for the sequential file type

6.7.2.4 Sequential with Custom Point Data File Type

The sequential with custom point (SEQ+CUSTOM PT) data file type is defined by a starting and an ending ID number, plus a series of custom points. The resulting file is inclusive of the start and end points, and all points in between. In addition, multiple thickness readings per ID number location are assigned using the assigned custom points.

Use the sequential with custom point data file type when you want, for example, to measure along a pipe or tube on which, at each ID number location, you can take measurements at the top, bottom, left, and right of the pipe (see an example in Table 8 on page 107).

Table 8 Resulting ID example for the SEQ+CUSTOM PT file type

START ID	END ID	Custom point	Resulting IDs
XYZ1267	XYZ1393	TOP	XYZ1267TOP
		BOTTOM	XYZ1267BOTTOM
		LEFT	XYZ1267LEFT
		RIGHT	XYZ1267RIGHT
			XYZ1268TOP
			XYZ1268BOTTOM
			XYZ1268LEFT
			...
			XYZ1393RIGHT

The allowable number of characters for each custom point depends on the number of ID characters defined in the start and end ID values. The total number of characters of the ID value plus the custom points cannot exceed 20. For example, when the start and end ID values are seven characters long, as shown in the example in Table 8 on page 107, the maximum allowable length for each custom point is thirteen ($20 - 7 = 13$).

To create a sequential data file with custom points

1. In the measurement screen, press **[FILE]**, and then select **CREATE** (see “Creating a Data File” on page 101 for details on the first parameters).
2. At the bottom of the **CREATE** screen, select **CONTINUE**.
3. In the second page of the **CREATE** screen (see Figure 6-20 on page 108):
 - a) Enter the **START ID** and **END ID** values.
 - b) Enter two or more **CUSTOM POINTS** values.
 - c) Press **[2nd F]**, **[▼]** to finish entering **CUSTOM POINTS** values.
 - d) Select **CREATE**.

FILE MENU		CREATE	
START ID		01	
END ID		10	
CUSTOM POINTS		-TOP	
		-BOTTOM	
INCREMENT STEP		1	
		CREATE	CANCEL
← to select, then ENTER.			
↓, ←, ENTER			

Figure 6-20 Defining an ID range for a sequential data file with custom points

6.7.2.5 2-D Grid Data File Type

A 2-D grid is a sequence of ID numbers arranged to describe a path in two dimensions. Each part of the ID number corresponds to a particular matrix dimension.

A 2-D (two-dimensional) sequence begins with the ID number that refers to the first column and the first row (see Figure 6-21 on page 109). The column (or row) then increments one value at a time until the sequence reaches the last column (or row) value, while the other dimension value stays constant. At this point, the other dimension increments from its first to last value. This continues until the ID number that refers to the last column and the last row is reached. You have the option to select whether the columns or the rows will be incremented first.

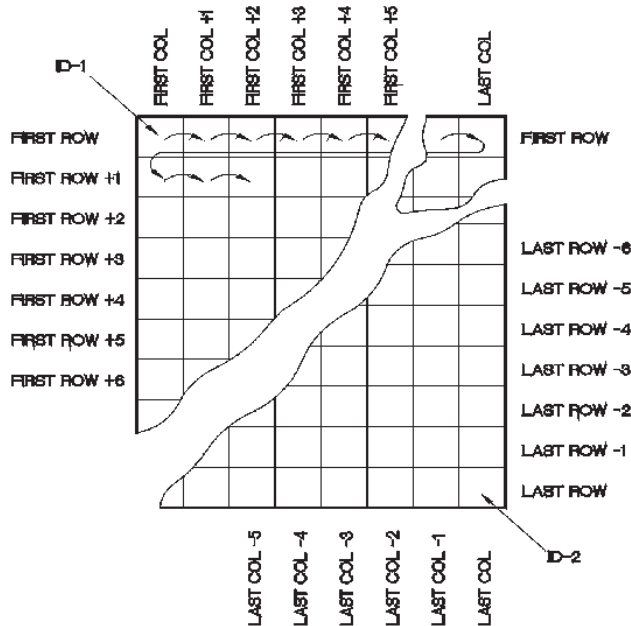

Figure 6-21 General 2-D grid example

A grid structure may associate one dimension of the grid with the physical parts whose wall thickness is to be measured. The particular measurement points on each part are then associated with the other dimension of the grid (see the example in Figure 6-22 on page 110).

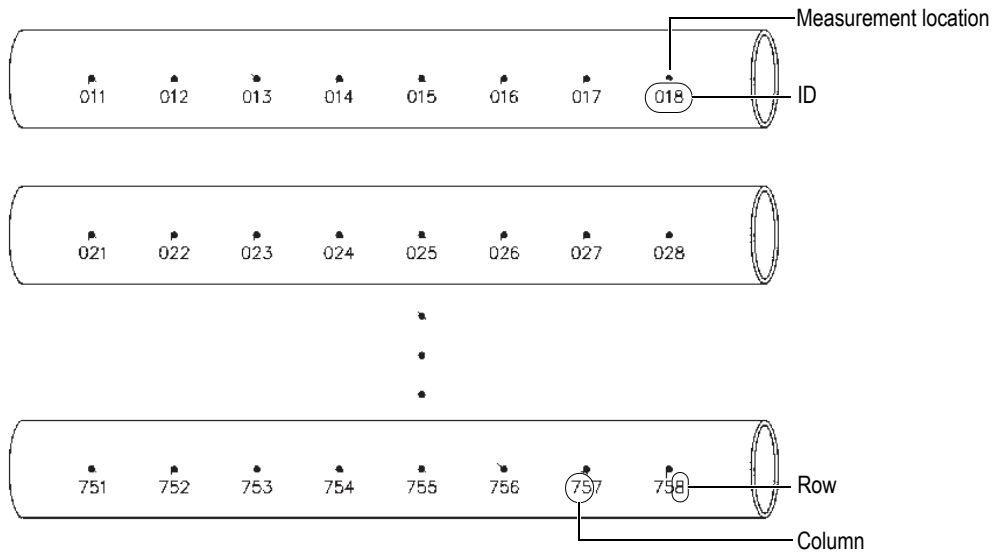

Figure 6-22 One grid for 75 identical parts

Alternatively, the rows and columns of a grid may refer to a two-dimensional map of measurement points on the surface of one part. In this case, a different grid is created for each part (see the examples in Figure 6-23 on page 111).

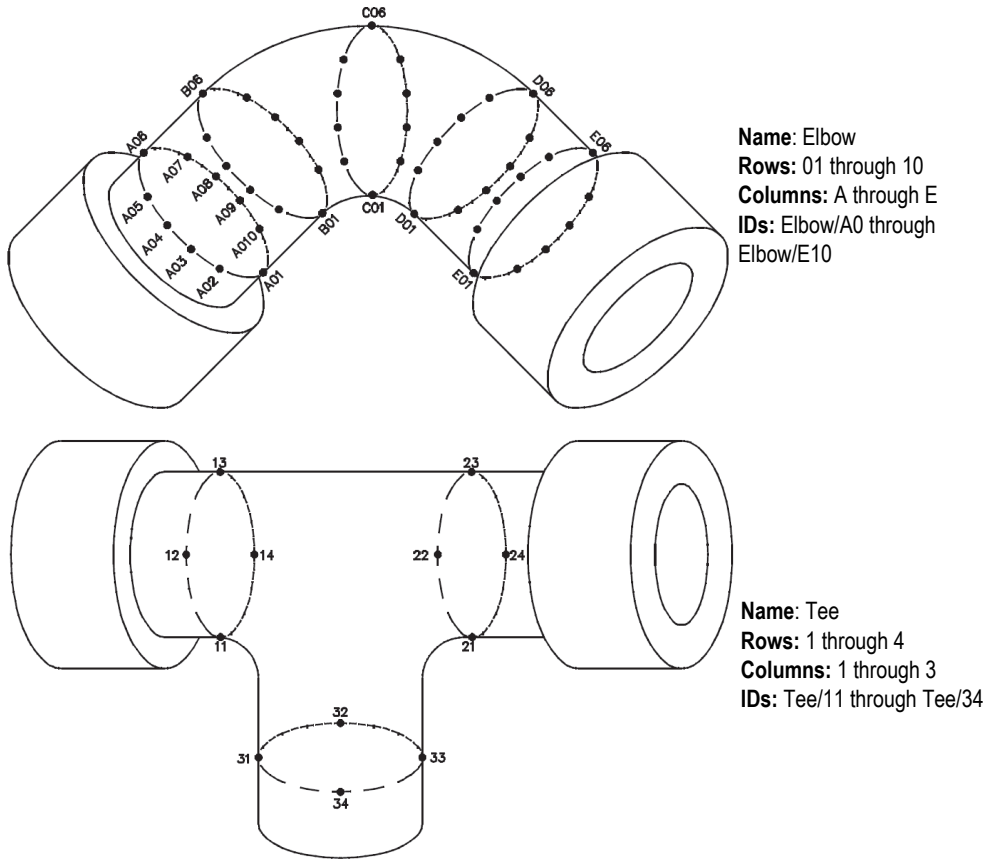

Figure 6-23 Differently named grid for each part

To create a 2-D grid data file

1. In the measurement screen, press **[FILE]**, and then select **CREATE** (see “Creating a Data File” on page 101 for details on the first parameters).
2. At the bottom of the **CREATE** screen, select **CONTINUE**.
3. In the second page of the **CREATE** screen (see Figure 6-24 on page 112):
 - a) Enter the **START COLUMN**, **END COLUMN**, **START ROW**, and **END ROW** values.
 - b) Select the **ID FORMAT** to determine how letters are incremented after Z:

- STANDARD:** A, B, C... Z, AA, AB, AC... ZZ.
EPRI: A, B, C... Z, AA, BB, CC... ZZ.
- c) In **INC 1ST BY**, select which parameter increments first (**ROW** or **COLUMN**).
- d) Select **CREATE**.

FILE MENU CREATE	
START COLUMN	A
END COLUMN	H
START ROW	01
END ROW	10
ID FORMAT	STANDARD
INC 1ST BY	ROW
<input type="button" value="CREATE"/> <input type="button" value="CANCEL"/>	
← to select, then ENTER.	
↓, ←, ENTER	

Figure 6-24 Configuring the ID range for a 2-D grid data file type

NOTE

The 45MG has the capability to add a row or a column, and to change the incrementation direction after a grid file is created (see “Editing a File” on page 118 for details).

6.7.2.6 Boiler Data File Type

A boiler file is a special file type designed specifically for boiler applications. A common method for identifying a thickness-measurement location is to use the following three dimensional approaches:

Elevation

The first dimension refers to the physical distance from the bottom of the boiler to the top.

Tube number

The second dimension refers to the number of the specific boiler tube to be inspected.

Custom points

The third dimension refers to the actual thickness reading location at the specified elevation on the specified tube.

The three dimensions are combined in a single ID number to precisely identify the exact location of each thickness reading. Table 9 on page 113 shows an example in which incrementation for the custom points was chosen first, the tube number second, and the elevation third.

Table 9 Resulting ID example for the BOILER file type

ELEVATIONS	START TUBE	END TUBE	CUSTOM POINTS	Resulting IDs
10FT	01	73	L (left)	10FT-01L
20FT			C (center)	10FT-01C
45FT			R (right)	10FT-01R
100FT				10FT-02L
				...
				10FT-73R
				20FT-01L
				...
				100FT-73R

To create a boiler data file

1. In the measurement screen, press **[FILE]**, and then select **CREATE** (see “Creating a Data File” on page 101 for details on the first parameters).
2. At the bottom of the **CREATE** screen, select **CONTINUE**.
3. In the second page of the **CREATE** screen (see Figure 6-25 on page 114):
 - a) Enter the **START TUBE** and **END TUBE** values.
 - b) Enter two or more **CUSTOM POINTS** values.
 - c) Press **[2nd F]**, **[▼]** to finish entering the **CUSTOM POINTS** values.
 - d) Enter two or more **ELEVATIONS** values.
 - e) Press **[2nd F]**, **[▼]** to finish entering the **ELEVATIONS** values.
 - f) In **INC 1ST BY**, select which parameter is to be incremented first (**POINT**, **TUBE**, or **ELEVATIONS**).

- g) In **INC 2ND BY**, select which parameter is to be incremented second (**POINT**, **TUBE**, or **ELEVATIONS**).
- h) Select **CREATE**.

Figure 6-25 Configuring the ID range for a boiler data file type

6.7.3 File Data Modes

When you create a data file on the 45MG, the file data mode must be selected in order to determine which measured values are stored in the file (see step 2.f in “Creating a Data File” on page 101). Table 10 on page 114 describes the available file data-mode options. Only one type of data can be stored in a file.

Table 10 File data-mode stored measurements

File data mode	Stored measurements	When to use
THICKNESS	Standard thickness Echo-to-echo thicknesses	When using basic thickness-measurement functions.
THRU COAT	Coating thickness Material thicknesses	When using THRU-COAT (see “Measurements with Optional THRU-COAT, D7906, and D7908 Transducers” on page 86).
VELOCITY	Velocity	When performing velocity measurements.

Table 10 File data-mode stored measurements (continued)

File data mode	Stored measurements	When to use
MIN/MAX	Minimum thickness Maximum thickness	When using the MIN/MAX mode (see “Using the Minimum, Maximum, or Min/Max Thickness Mode” on page 139).
TIME OF FLT	Time of flight	When measuring time of flight
REDUCTION RT	Material thickness Reduction rate	When the reduction rate differential mode is activated (see REDUCTION RT in “Using Alarms” on page 141)

The default file data mode can be set to the most frequently used.

To change the default file data mode

1. In the measurement screen, press **[SETUP]**, and then select **SYSTEM**.
2. In the **SYSTEM** screen, set **DEFAULT FILE MODE** to the desired option (see Table 10 on page 114 for details).
3. Press **[MEAS]** to return to the measurement screen.

6.7.4 Performing File Operations

Pressing **[FILE]** opens a menu from which numerous file operations can be performed (see Figure 6-26 on page 116). The following sections describe how to perform the operations. Datalogger files are stored in the internal microSD memory card, and these files can be imported/exported from/to an external microSD memory card.

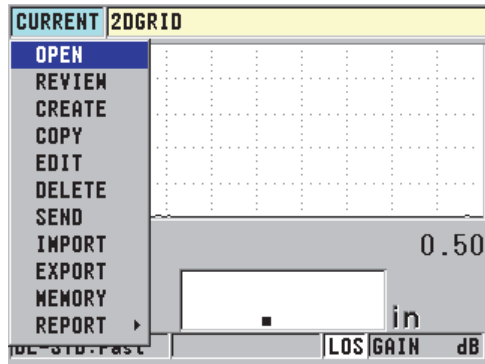

Figure 6-26 The FILE menu

6.7.4.1 Opening a File

You can open an existing file to make it the active file in which new measurements are saved.

To open a file

1. Press **[FILE]**, and then select **OPEN**.
2. In the **OPEN** screen (see Figure 6-27 on page 117):
 - a) In **SORT BY**, select the order in which the files appearing on-screen are sorted (by **NAME** or by **DATE CREATED**).
 - b) In the list of files, select the file you want to open.
The descriptive header for the highlighted file name appears on the lower section of the display.
 - c) Select **OPEN** to return to the measurement screen with the selected file set as the active file, and the ID number set to the first ID number in the file.

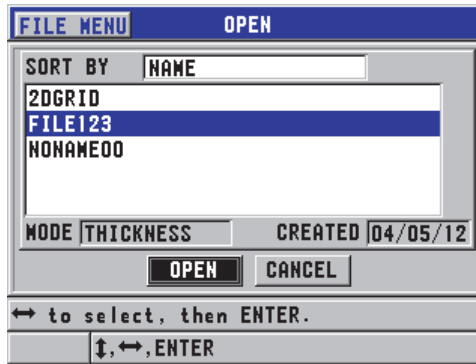

Figure 6-27 Opening a file

6.7.4.2 Reviewing a File

There are two ways to review the contents of a file stored in the internal datalogger: by using **OPEN** or **REVIEW** in the **FILE** menu.

To review a file using **OPEN**

1. Press **[FILE]**, and then select **OPEN**.
2. Press **[2nd F]**, **[FILE]** (ID#) to open the file review screen (see “ID Review Screen” on page 125).

To review a file using **REVIEW**

1. Press **[FILE]**, select **REVIEW**, and then press **[ENTER]**.
2. In the **OPEN** screen, choose **SORT BY**, and then select **NAME** or **DATE CREATED** to select how files are displayed on-screen.
3. In the list of files, select the file you want to review. The descriptive header for the highlighted file name appears on the lower section of the screen.
4. Select **REVIEW** to go to the file **REVIEW** screen for the selected file.

6.7.4.3 Copying a File

It is possible to duplicate a file that already exists in the datalogger. The file copy function is useful for creating a new file with the exact same ID number structure as a previously created file. You can also choose to copy the thickness data.

The file copy function can only be used to copy an existing file in the internal memory to the internal memory. Use the file import and export functions to copy data to and from the internal memory and the external microSD card.

To copy a file

1. In the measurement screen, press **[FILE]**, and then select **COPY**.
2. In the **COPY** screen (see Figure 6-28 on page 118):
 - a) In the list, select the source file.
 - b) In **COPY NAME**, enter the file name for the destination file.
 - c) Set **COPY THICKNESS DATA?** to **YES** when you also want to copy the thickness readings from the original file into the new file.
 - d) Select **COPY**.

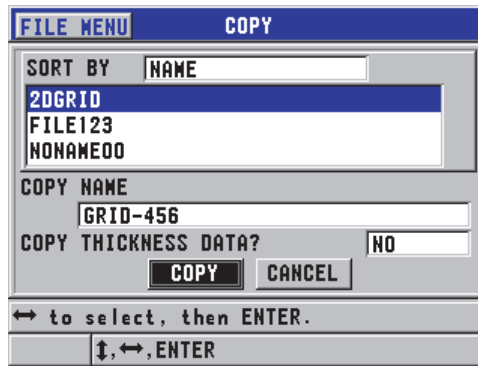

Figure 6-28 Copying a file

3. Open the newly created file in order to make it the active file (see “Opening a File” on page 116.)

6.7.4.4 Editing a File

Once a file is created, the edit function can be used to change the following file parameters:

- File name
- File description
- Inspector ID

- Location note
- Delete protection (on/off)
- End row, column, or point of a grid file
- Incrementing order of a grid file
- Incrementing direction (forwards or reverse) for rows, columns, points, tube numbers, and elevations

The edit function does not allow you to edit the file type, and cannot be used to edit individual measurement identifiers (ID), or actual thickness readings.

To edit an existing file

1. In the measurement screen, press **[FILE]**, and then select **EDIT**.
2. In the **EDIT** screen (see Figure 6-29 on page 120):
 - a) In the list, select the file you want to edit.

NOTE

When scrolling through the file names, a descriptive header for the highlighted file name appears on the lower section of the display. This information can assist in selecting the proper file if you are uncertain of the exact file name.

- b) To rename the file, edit the **NAME** value.
- c) Edit the file description (**DESC**), the inspector identification (**INSP ID**), and the location note (**LOC NOTE**) values as needed.
- d) To change the file lock state, set **DELETE PROTECTION** to **ON** or **OFF**.
- e) For a nongrid file, select **UPDATE**.

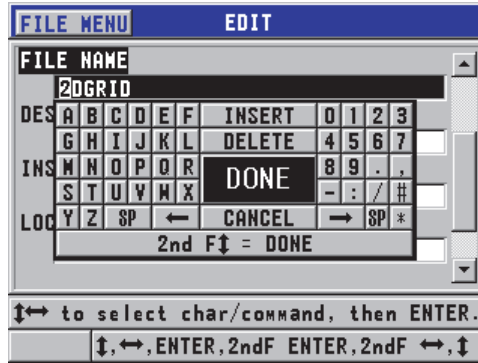

Figure 6-29 Entering new file information

3. For a grid file, select **CONTINUE**, and then perform the following actions in the second page of the **EDIT** screen (see Figure 6-30 on page 121):
 - a) Increase the **END COLUMN** and **END ROW** values as needed. These values cannot be decreased.
 - b) If needed, change the **INC 1ST BY** value.
 - c) Change the incrementing direction of rows, columns, points, tubes, and elevations.
FORWARD increments in the direction specified when the file was created, and **REVERSE** increments in the opposite direction of how the file was originally created.
 - d) Select **UPDATE**.

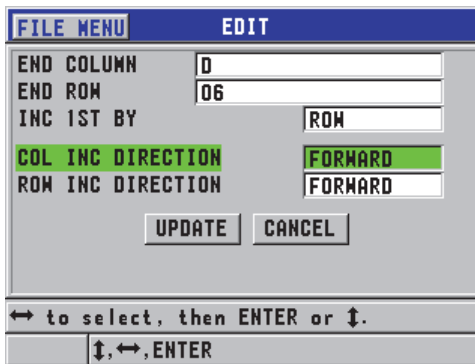

Figure 6-30 Displaying the grid edit screen

6.7.4.5 Deleting a File or Its Contents

The file delete function can be used to completely erase the file from the datalogger memory, or to erase the contents of a file. Files that are delete-protected cannot be deleted until the delete protection is disabled (see “Editing a File” on page 118.)



CAUTION

Once a file is deleted, it is not possible to recover any information previously contained in that file.

To delete a file stored in the 45MG

1. In the measurement screen, press **[FILE]**, and then select **DELETE**.
2. In the **DELETE** screen (see Figure 6-31 on page 122):
 - a) Set **DELETE ON** to **FILE** in order to delete an entire file.
 - b) In the list, select one or more files that you want to delete.
A check mark appears on the right of the line of files selected.
 - c) Press **[2nd F]**, **[▼]** to leave the list.
 - d) Select the desired **Delete Stored Data** or **Entire File** option.
 - e) Set **DELETE MODE** to **DATA** if you only want to delete the contents of the file.

OR

Set **DELETE MODE** to **FILE** if you want to completely erase the file from the memory.

- f) Press **ENTER** to confirm the operation.

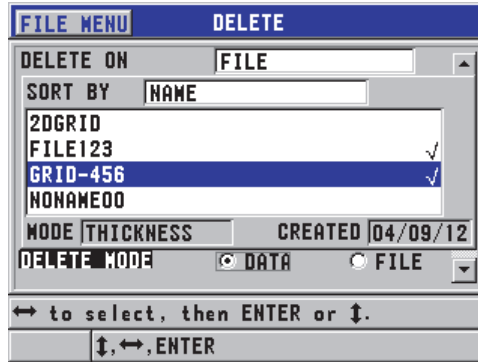

Figure 6-31 Deleting a file

NOTE

If you select multiple files for deletion, and some of those files are delete-protected, the 45MG will only delete the files that are not delete-protected.

6.7.4.6 Deleting a Range of IDs

It is possible to delete a range of IDs in the active file by using the clear memory function. This function deletes both the data and the ID number locations for incremental and manual (built in GaugeView) data files. For other data file types, only the data is deleted, not the ID number locations.

To delete a range of IDs in a file

1. In the measurement screen, press **[FILE]**, and then select **DELETE**.
2. In the **DELETE** screen (see Figure 6-32 on page 123), set **DELETE ON** to **ID RANGE**.

3. Edit the **STARTING ID** and the **ENDING ID** values to define the range of IDs you want to delete from the file.
4. Select **DELETE**.

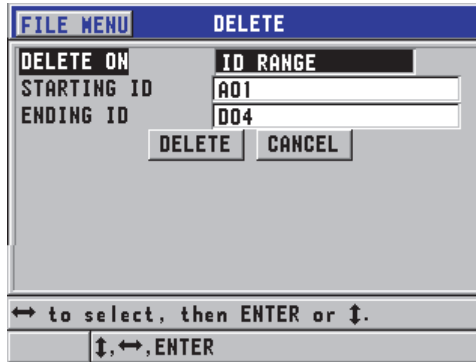

Figure 6-32 Deleting the data of an ID range in the active file

6.7.4.7 Deleting All Data Files

The reset function can be used to quickly erase all the files stored in the 45MG.



CAUTION

Using the internal memory reset or master reset erases all files, and the data contained in those files. The deleted files and the data they contain cannot be recovered. The datalogger will be completely empty after this procedure.

To delete all files

1. In the measurement screen, press **[SETUP]**, and then select **RESETS**.
2. In the **RESETS** screen (see Figure 6-33 on page 124):
 - a) In the **RESETS** list, select **INTERNAL MEMORY RESET** or **MASTER RESET** to delete all files on the internal microSD memory card.

- b) Select **RESET** to delete all the files.
OR
Select **CANCEL**, or press **[MEAS]** to abort the operation.

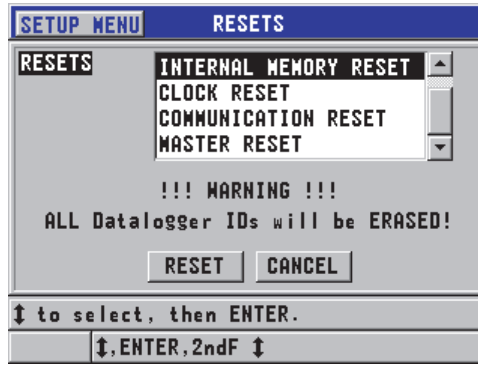

Figure 6-33 Warning message when resetting measurements

6.7.4.8 Viewing the Memory Status

To view the memory status

1. Press **[FILE]**, select **MEMORY**, and then press **[ENTER]** to display the **MEMORY** status screen (see Figure 6-34 on page 124). This screen indicates the number of files stored in the internal memory, along with its current capacity.

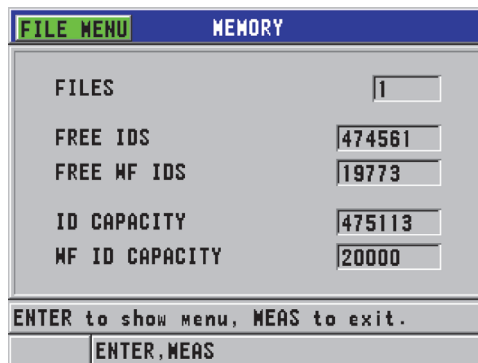

Figure 6-34 The MEMORY status screen

6.7.5 Setting the ID Overwrite Protection

The ID overwrite protection can be activated to warn you every time you attempt to overwrite an existing measurement in a file. This function can be enabled at any time.

When the ID overwrite protection is enabled, a message appears (see Figure 6-35 on page 125) on the help text bar when you perform a save to inform you that the existing thickness readings/waveforms will be overwritten. Select **YES** to replace the previous reading with the new one, or **NO** to leave the original value.

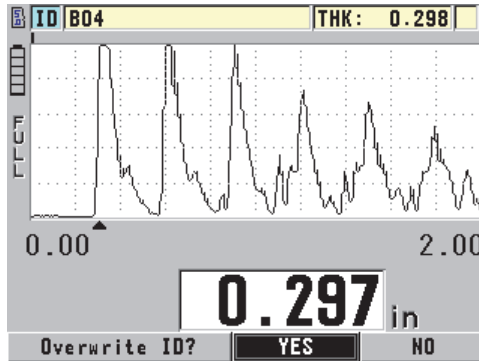

Figure 6-35 The ID overwrite protection message

To set the ID overwrite protection

1. In the measurement screen, press **[SETUP]**, and then select **MEAS**.
2. In the **MEAS** screen, set **ID OVERWRITE PROT** to **ON** or **OFF**.
3. Press **[MEAS]** to return to the measurement screen.

6.7.6 ID Review Screen

To review the data stored in the active file, use the ID review screen. To toggle the state of the ID review screen, press **[2nd F]**, **[FILE]** (ID#). The ID review screen shows the waveform and the data for the active ID.

Figure 6-36 on page 126 shows an example of the ID review screen and describes its contents. The area under the waveform is reserved for status flags describing the displayed stored thickness values. The flags are the same single letter abbreviations for status words transmitted by the gauge using the send commands (see “Managing Communications and Data Transfer” on page 195).

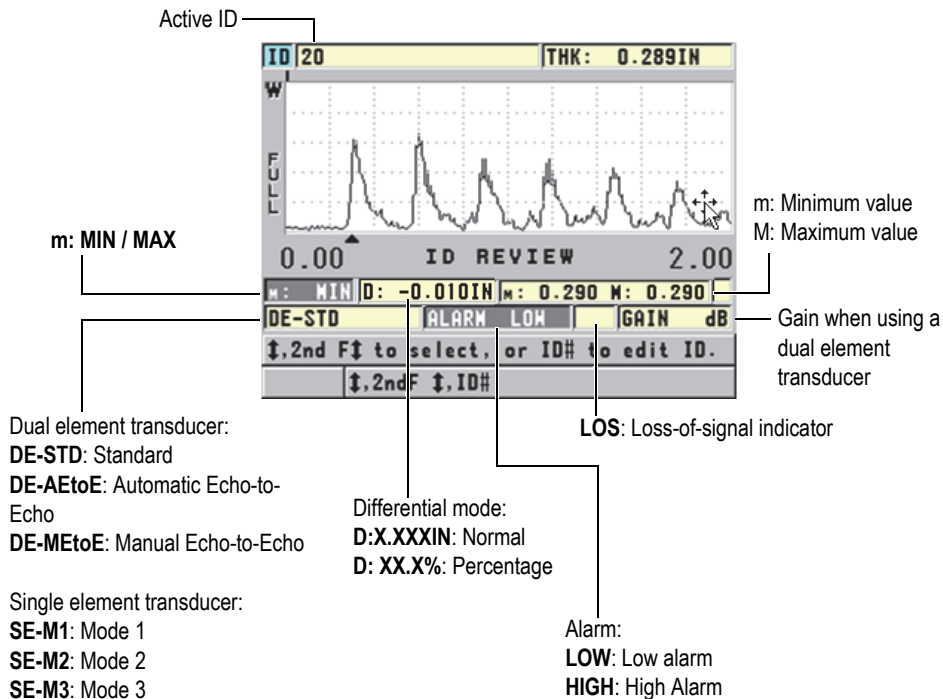

Figure 6-36 Identifying the ID review screen

The ID review screen has three purposes, as follows:

- Reviewing datalogger contents by scanning through stored ID locations in the active file.
- Moving within the data file and changing the current ID location to any location that already exists in the data file.
- Changing the current ID location to any location that already exists in the data file for the purpose of editing that ID location.

6.7.6.1 Reviewing Stored Data and Changing the Active ID

The ID review screen is used to review the data in the active file.

To review stored data and change the active ID

1. Open the file you want to review (see “Opening a File” on page 116).
2. In the measurement screen, press **[2nd F]**, **[FILE]** (**ID#**).
3. While in the ID review screen (see Figure 6-36 on page 126), perform the following actions:
 - a) Review the waveform, status flags, and measured values for the active ID.
 - b) Press **[▲]** to display the data for the next ID in the file.
 - c) Press **[▼]** to display the data for the previous ID in the file.
 - d) Press **[2nd F]**, **[▲]** and **[2nd F]**, **[▼]** to jump respectively to the last ID and the first ID in the file.
 - e) Press **[2nd F]**, **[FILE]** (**ID#**) to edit the ID (see “Editing the ID” on page 127).
4. Press **[MEAS]** to return to the measurement screen with the new active ID.

6.7.6.2 Editing the ID

The ID can be edited as follows:

- Change the active ID to quickly jump to an existing ID. This is useful when you are using a large file, and it would take too long to locate the desired ID using the arrow keys.
- Change the active ID to a new ID that does not yet exist in the file. This mode is useful when you want to include additional measurement points in the active file. Additional IDs can be added anywhere in the database (beginning, middle, and end).

NOTE

No stored data is shown while the ID is being edited.

To use the ID edit mode

1. Open the file containing the ID you want to edit an ID (see “Opening a File” on page 116).

2. In the measurement screen, press **[2nd F]**, **[FILE]** (**ID#**).
3. Select the ID you want to edit (see "Reviewing Stored Data and Changing the Active ID" on page 127).
4. Press **[2nd F]**, **[FILE]** (**ID#**) again, and then edit the ID value (see Figure 6-37 on page 128).

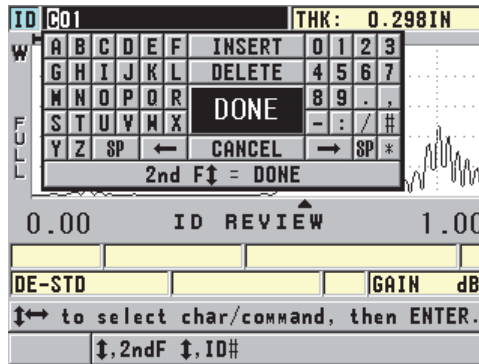

Figure 6-37 Editing the ID # edit mode

5. Press **[MEAS]** to return to the measurement screen with the new active ID.
6. When the edited ID is not in the database, the help text bar message shown in Figure 6-38 on page 129 appears. Select **INSERT** to insert the new ID in front of the active ID.
OR
Select **APPEND** to add the new ID to the end of the file.

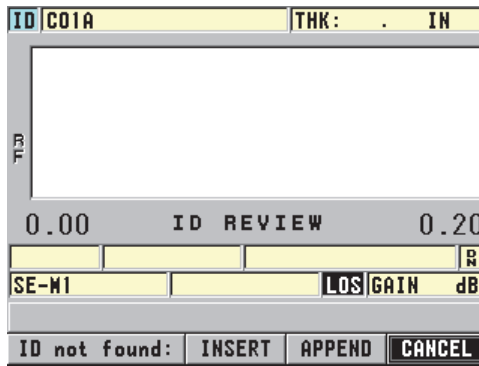

Figure 6-38 The message when the edited ID is not in the database

7. Press [SAVE] with or without an active measurement to make the edited ID a permanent part of the database.
The sequence resumes at the previous active ID.

6.7.6.3 Erasing Data in the Active File



CAUTION

Data erased using the following techniques **CANNOT** be recovered.

To erase a single measurement

1. In the measurement screen, press [2nd F], [FILE] (ID#).
The ID review screen appears and shows the active ID with its stored data.
2. Select the ID to be erased (see “Reviewing Stored Data and Changing the Active ID” on page 127), and then press [MEAS].
3. Press [SAVE] when not getting a reading to save “---.---”, and then erase the single reading ID.
The displayed ID changes to the next ID in the sequence.

TIP

The easiest way to replace a thickness reading is to save a new measurement at the desired ID in the measurement screen. If you do not want to save a measurement at a specific ID, press **[SAVE]** in the measurement screen when you are not taking a measurement. This stores an LOS condition and --.-- at the specific ID number.

4. Press **[MEAS]** to return to the measurement screen.
-

NOTE

When a measurement stored in incremental files is deleted, the ID is also deleted. In all other file types, only the thickness and waveform data is deleted.

6.7.7 Generating Reports

The 45MG can generate inspection data reports without having to be connected to a computer or printer. The following reports are available:

File summary

Shows basic statistics for the file (minimum thickness and location, maximum thickness and location, and high and low alarm conditions along with the mean, median, and standard deviation).

Minimum/Maximum summary

Shows a list of ID number locations that have the minimum and maximum thickness in a file.

Alarm summary

Shows a list of all the ID number locations where a low alarm and high alarm occurred.

File comparison

Allows you to select two files and compare them. The first file contains the previous inspection data, and the second file contains the current inspection data. The report indicates the maximum wall loss and any area of greater wall thickness (growth), and their ID number locations.

Minimum Review

Allows you to select a file, and then review all the minimum thickness locations in the file. In addition to verifying the thickness at all minimum locations, you can replace these minimum thickness locations if necessary.

To generate a report

1. In the measurement screen, press **[FILE]**, and then select **REPORT**.
2. In the submenu, select the desired type of report. If you select:
 - **FILE SUMMARY**, go to step 3
 - **MIN/MAX SUMMARY**, go to step 4
 - **FILE COMPARISON**, go to step 5
 - **ALARM SUMMARY**, go to step 6
 - **MIN REVIEW**, go to step 7
3. In the **FILE SUMMARY** screen (see Figure 6-39 on page 131):
 - a) Select the file for which you want to create the report.
 - b) Select **REPORT**.
The **FILE SUMMARY** report result screen opens (see Figure 6-40 on page 132).

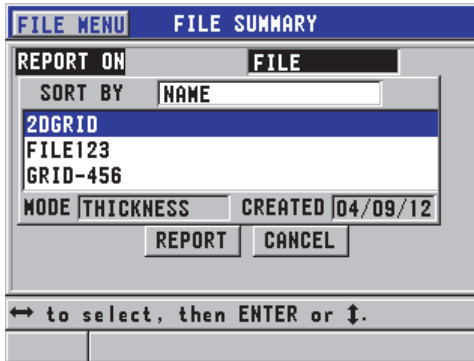

Figure 6-39 The FILE SUMMARY report screen

FILE SUMMARY			
START ID	A01		
END ID	D04		
TOTAL ID COUNT	16		
#MINS	1	MIN VAL	0.297
#MAXS	5	MAX VAL	0.299
#HI ALARMS	0	%HI	0.0%
#LO ALARMS	0	%LOW	0.0%
MEAN	0.298	MEDIAN	0.298
STD DEV	0.001		
CANCEL		NEW REPORT	

Figure 6-40 The FILE SUMMARY report result screen

- c) Select **CANCEL** to return to the measurement screen, or **NEW REPORT** to generate another report.
4. In the **MIN/MAX SUMMARY** screen:
 - a) Select the file for which you want to create the report.
 - b) Select **REPORT**.
The **MIN/MAX SUMMARY** report result screen opens with the first min ID # highlighted (see Figure 6-41 on page 132).

MIN/MAX SUMMARY			
MIN VAL	0.297	MAX VAL	0.299
#MINS	<div style="border: 1px solid black; padding: 2px;"> 1 B04 </div>		
#MAXS	<div style="border: 1px solid black; padding: 2px;"> 5 C04 D01 D02 </div>		
CANCEL		NEW REPORT	

Figure 6-41 The MIN/MAX SUMMARY report screen

- c) Press **[2nd F]**, **[▲]** or **[2nd F]**, **[▼]** to move between the #MINS and #MAXS lists.

- d) Select **CANCEL** to return to the measurement screen, or **NEW REPORT** to generate another report.
5. In the **FILE COMPARISON** screen (see Figure 6-42 on page 133):
 - a) In the upper list, select the reference file you want to use in the comparison.
 - b) In the lower list, select the comparison file (containing newer data for the same measurement points).
 - c) Select **REPORT**.
The **FILE COMPARISON** report result screen opens with the first maximum wall-loss ID highlighted (see Figure 6-43 on page 133).

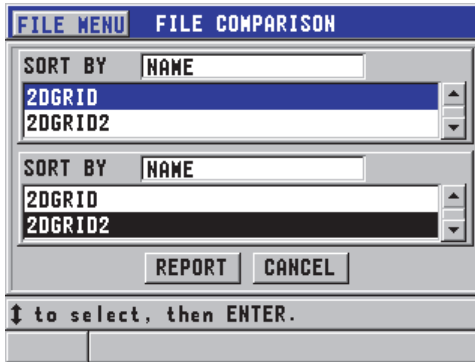

Figure 6-42 The FILE COMPARISON report screen

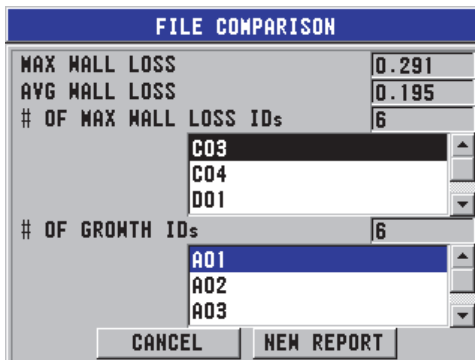

Figure 6-43 The FILE COMPARISON report result screen

- d) Review the maximum wall-loss location list, and the maximum wall growth location list.
 - e) Select **CANCEL** to return to the measurement screen, or **NEW REPORT** to generate another report.
6. In the **ALARM SUMMARY** screen:
- a) Select the file for which you want to generate the report.
 - b) Select **REPORT**.
The report page of the **ALARM SUMMARY** screen opens with the first low alarm location ID highlighted (see Figure 6-44 on page 134).

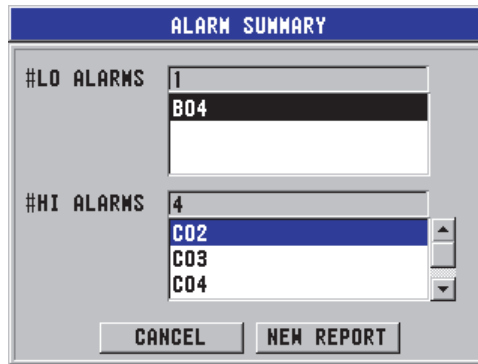

Figure 6-44 The ALARM SUMMARY report result screen

- c) Review the low and the high alarm location lists.
 - d) Select **CANCEL** to return to the measurement screen, or **NEW REPORT** to generate another report.
7. In the **MIN REVIEW** screen:
- a) Select the file for which you want to generate the report.
 - b) Select **REPORT**.
The **MIN REVIEW** report result screen opens with the minimum thickness ID highlighted (see Figure 6-45 on page 135).

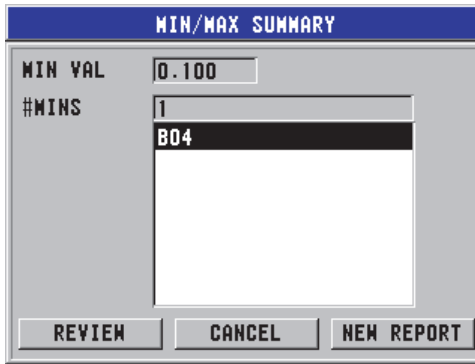

Figure 6-45 The MIN/MAX SUMMARY report result screen

- c) In the list, select an ID.
The 45MG returns to the live measurement screen at the selected minimum ID in the file (see Figure 6-46 on page 135).

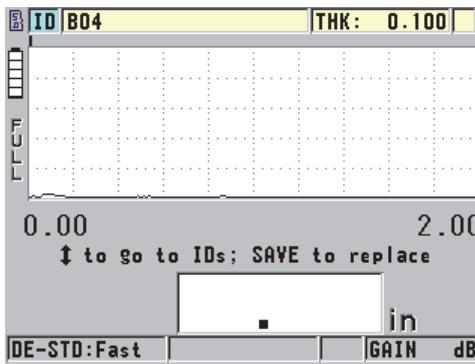

Figure 6-46 Returning to the measurement screen

- d) Couple the probe back to the minimum ID location to verify the thickness, and then press [SAVE] to store the new measurement.
- e) Use the [▲] and [▼] keys to move to other minimum review list IDs.
- Press [MEAS] to exit the minimum review.

7. Using Special Functions

This chapter describes how to use special 45MG functions and modes; for example, differential and thickness modes, alarms, instrument lock, and display freezing. Although the features outlined in this section are not required for basic thickness operation, they can make the gauge a more versatile instrument.

7.1 Activating and Configuring a Differential Mode

The 45MG includes differential modes that can be used to easily compare the actual measurement with an entered reference value. The actual thickness measurement appears on the thickness display, and the differential value appears in the differential display area (see Figure 7-1 on page 137).

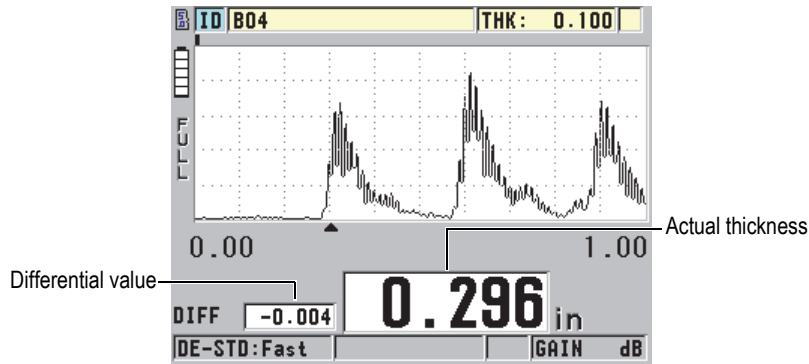

Figure 7-1 Normal differential mode (Waveform option activated)

The units and resolution of the differential thickness are the same as those selected for the thickness measurement.

When you press [SAVE] (with the optional datalogger) while in the **NORMAL** or **% RATIO** differential modes, the 45MG saves the actual thickness value along with the “D” flag indicating that the **Differential** mode is active.

To activate and configure a differential mode

1. In the measurement screen, press [SETUP], and then select **DIFF**.
2. In the **DIFF** screen (see Figure 7-2 on page 139):
 - a) Set **DIFF ENABLE** to **ON** to activate the differential function.
 - b) In **DIFF MODE**, select one of the three differential modes:
 - **NORMAL**: Shows the actual thickness, along with the difference between the actual thickness measurement and the **REF VALUE** entered.

$$\text{Differential}_{Normal} = \text{Current thickness} - \text{Reference value}$$

- **% RATIO**: Shows the actual thickness along with the percent difference from the **REF VALUE** entered.

$$\text{Differential}_{\% \text{ Ratio}} = \frac{\text{Current thickness} - \text{Reference value}}{\text{Reference value}} \times 100$$

- **REDUCTION RT**: Shows the actual thickness, in addition to the percent difference between the actual thickness and the former value. The former value is the thickness of the metal prior to the bending process. Use this mode for metal bending, or any other application in which you need to track the percentage of wall thinning.
- c) When **DIFF MODE** is set to either **NORMAL** or **% RATIO**, enter the reference value in the **REF VALUE** text box.

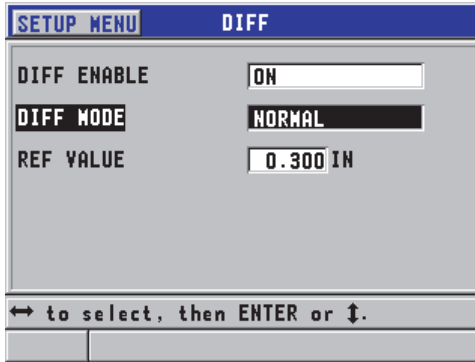

Figure 7-2 The DIFF screen

When **DIFF MODE** is set to **REDUCTION RT** only:

- d) In the **FORMER THICKNESS** text box, enter the original thickness value, as measured before bending the metal.
 - e) In the **LARGE FONT** text box, select which measurement is to appear at the bottom of the measurement screen with the large type font (**THICKNESS** or **REDUCTION RT**).
3. Press **[MEAS]** to return to the measurement screen with the displayed differential value.

7.2 Using the Minimum, Maximum, or Min/Max Thickness Mode

The minimum, maximum, or min/max thickness modes can be activated to display retained minimum and/or maximum thickness values. The **MIN** and/or **MAX** values appear on the left side of the main thickness reading (see Figure 7-3 on page 140). The minimum or maximum thickness value replaces the main thickness display when the transducer is uncoupled, or when a loss of signal (LOS) occurs. The replacement value appears in an outlined font.

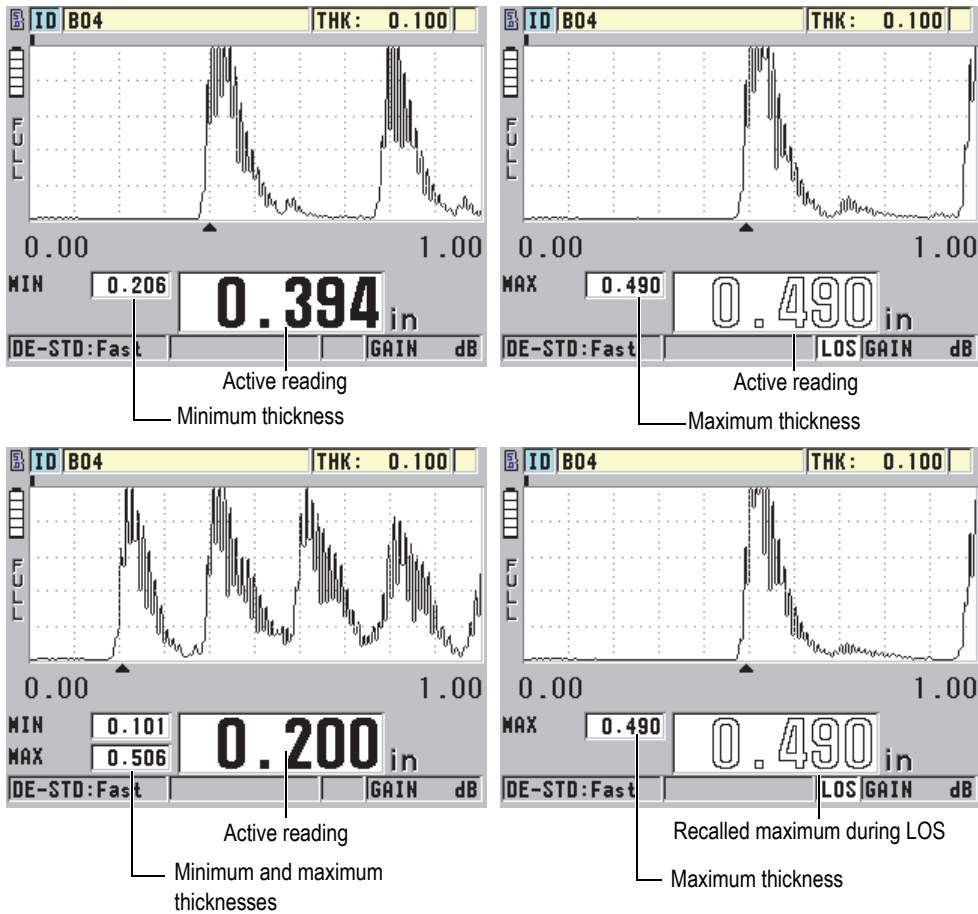

Figure 7-3 Displaying the Min and/or Max thickness (Waveform option activated)

NOTE

The fastest display update rate is automatically activated when entering the minimum or maximum thickness mode. When leaving the mode, the display update rate is restored to its previous state.

The minimum and maximum thickness modes display the smallest and largest thickness value measured from the time you activate or reset the minimum mode. The modes are useful when determining the thinnest/thickest reading obtained while making a series of readings on a test piece.

To activate the minimum, maximum, or min/max mode

1. In the measurement screen, press **[SETUP]**, and then select **MEAS**.
2. In the **MEAS** screen, set **MIN/MAX** to the desired mode (**OFF**, **MIN**, **MAX**, or **BOTH**).
3. Press **[MEAS]** to return to the measurement screen.
4. In the measurement screen, press **[MEAS]** again to reset the held minimum, maximum, or min/max values.

The thickness display will blank, indicating that the old **MIN/MAX** value is reset. Saving or sending a **MIN/MAX** reading also resets the value.

7.3 Preventing False Minimum/Maximum Thickness Readings

A false minimum or maximum reading can occur when you lift the transducer from the test piece. This is due to excess couplant (particularly on smooth surfaces), which causes the instrument to read the thickness of a couplant drop when you lift the transducer.

To prevent false minimum/maximum thickness readings

1. Activate the minimum or maximum thickness mode (see “Using the Minimum, Maximum, or Min/Max Thickness Mode” on page 139).
2. Before uncoupling the transducer, press **[FREEZE]** to freeze the measurement or optional waveform.
3. Once the transducer is uncoupled, press **[FREEZE]** again to unfreeze the display and recall the minimum thickness and optional waveform.

7.4 Using Alarms

Any one of the 45MG alarm modes can be activated to help you identify when the actual thickness measurement is above or below editable reference values.

When an alarm condition occurs, the 45MG warns you, as follows:

- The **HIGH** or **LOW** alarm indicator flashes with a red background at the bottom right corner of the measurement screen (see Figure 7-4 on page 142).
- The thickness value appears in red.
- When the beeper is active (see “Setting the User Interface Language and Other System Options” on page 53), the 45MG emits a long beep.

NOTE

The thickness value and alarm indicator only appear in color when the indoor color scheme is active (see “Color Schemes” on page 57 to change the color scheme).

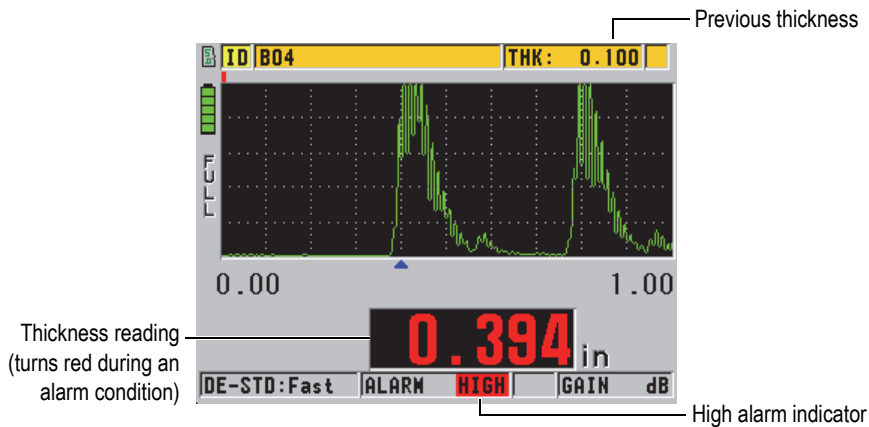

Figure 7-4 Example of a HIGH alarm indicator (Waveform option activated)

When the Datalogger option has been purchased, the datalogger records an alarm condition in the second status box for all stored measurements. An **A** indicates the alarm mode, an **L** indicates a low alarm condition, and an **H** indicates a high alarm condition.

There are three different alarm modes (**STANDARD**, **B-SCAN**, and **REDUCTION RT**):

STANDARD

The standard alarm warns you when the actual measured thickness is below a low reference value, or above a high reference value. The reference values are thickness set points using the current instrument units and resolution.

NOTE

The **B-SCAN** and **REDUCTION RT** alarms are only available when the B-scan or reduction rate (**DIFF** mode) are activated. These functions must be turned on first before the **B-SCAN** and **REDUCTION RT** alarms can be activated.

B-SCAN

The B-scan alarm mode is similar to the standard alarm mode, except that in the B-scan alarm mode, lines are shown in the B-scan grid when the reference values fall within the B-scan thickness range (see Figure 7-5 on page 143). In addition, the alarms are operational while you review B-scan thicknesses in the B-scan freeze review mode.

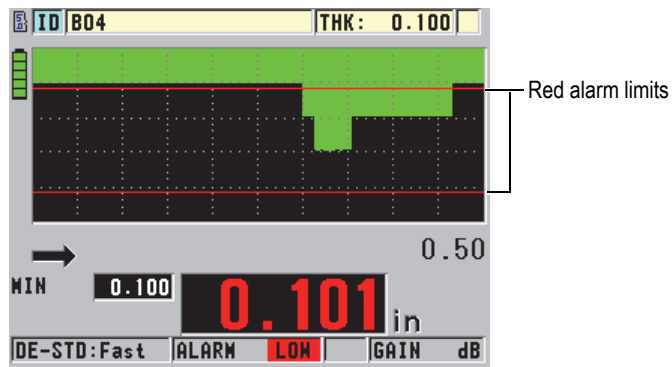

Figure 7-5 Example of a B-scan alarm mode

NOTE

The thickness value and the alarm indicator only appear in color when the indoor color scheme is active (see “Color Schemes” on page 57 to change the color scheme).

REDUCTION RT

The **REDUCTION RT** option only appears when the active file is configured with **FILE DATA MODE** set to **REDUCTION RT**. You set the reduction percentage for the low (**YELLOW ALARM**) and high (**RED ALARM**) limits, following which the instrument displays (see Figure 7-6 on page 144):

- The **RED** indicator for reduction rates that are greater than or equal to the **RED ALARM** value.
- The **YEL** indicator for reduction rates that are between the **YELLOW ALARM** and the **RED ALARM** values.
- The **GRN** indicator for reduction rates that are below the **YELLOW ALARM** value.

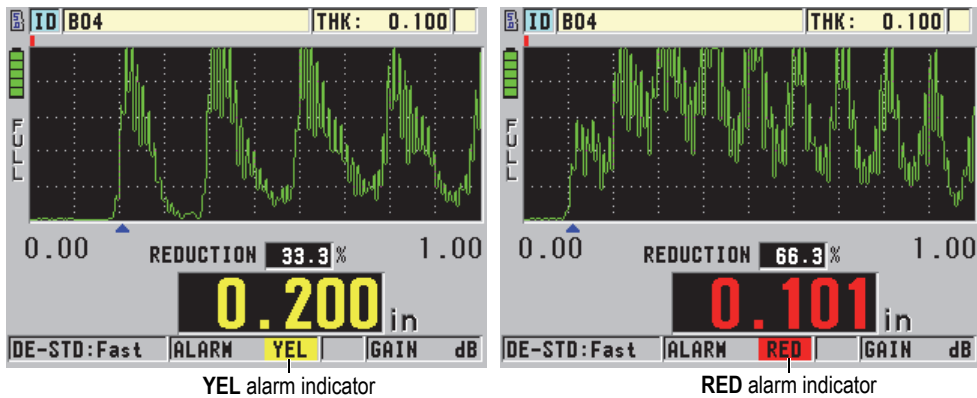

Figure 7-6 YEL (yellow) and RED alarm indicators (Waveform option activated)

To set the alarm

1. In the measurement screen, press **[SETUP]**, and then select **ALARM**.
2. In the **ALARM** screen (see Figure 7-7 on page 145):
 - a) Set **ALARM ENABLE** to **ON** to activate the alarm function.
 - b) In **ALARM MODE**, select the desired alarm mode (**STANDARD**, **B-SCAN**, or **REDUCTION RT** [reduction rate]).
The other parameters vary depending on the alarm mode selection.

NOTE

The **B-SCAN** option only appears when the B-scan mode is active (see “Using the B-Scan” on page 164).

The **REDUCTION RT** option only appears when the active file is configured with the **FILE DATA MODE** parameter set to **REDUCTION RT** (see “File Data Modes” on page 114).

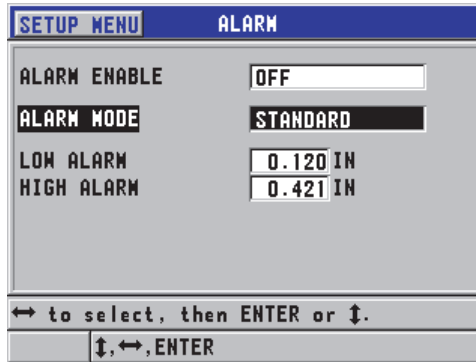

Figure 7-7 Setting up the STANDARD alarm

- When **ALARM MODE** is set to **STANDARD** or **B-SCAN**, set the **LOW ALARM** and the **HIGH ALARM** values.
OR
When **ALARM MODE** is set to **REDUCTION RT**, set the **YELLOW ALARM** and the **RED ALARM** values.
- Press **[MEAS]** to return to the measurement screen.

NOTE

Alarm reference values that were entered in one unit system are displayed as the equivalent value when the alternate units are selected.

7.5 Locking the Instrument

The 45MG is equipped with an instrument lock that can be used by a supervisor to restrict access to selected functions. The supervisor can also enter a password to prevent other users from unlocking the functions. Once a password has been set, you must reenter the password before you can lock or unlock any function.

The following functions can be locked:

- Calibration with [CAL VEL] and [CAL ZERO]
- Gain and waveform adjustments with [GAIN/WAVE ADJ]
- Transducer setup recall with [XDCR RECALL]
- Setup menu accessed with [SETUP]
- File menu or datalogger operations accessed with [FILE]

NOTE

When locking [CAL VEL] and [CAL ZERO], the function ([2nd F], [CAL ZERO] (Do ZERO)) is still available.

Locking the calibration prevents changes to calibration values, thus preventing parameters from affecting the value of the measurement, including material velocity and test-block zero calibration. However, you can still view these values, use the measurement screen, and use the datalogger functions.

Anytime a user attempts to use a locked function, a message appears in the help bar to indicate that the function is locked (see Figure 7-8 on page 146).



Figure 7-8 Example of a locked function message in the help bar

To set the password

1. In the measurement screen, press [SETUP], and then select **PASSWORD**.

2. In the **PASSWORD** screen (see Figure 7-9 on page 147), enter your password using up to eight alphanumeric characters.

IMPORTANT

If you forget your password, you can unlock the instrument and deactivate the password by entering the master password: "OLY45MG".
To change the password, you must first use the master password to deactivate the password, and then set a new password.

3. Select **DONE** to activate the instrument lock and return to the measurement screen.



Figure 7-9 The **PASSWORD** screen

To lock and unlock instrument functions

1. In the measurement screen, press **[SETUP]**, and then select **LOCKS**.
2. In the **LOCKS** screen (see Figure 7-10 on page 148):
 - a) If a password was set, enter the password in the **ENTER PASSWORD** text box.
 - b) Set the functions you want to lock to **LOCKED**, and the ones you want to unlock to **UNLOCKED**.
 - c) Select **SET** to activate the instrument lock and return to the measurement screen.

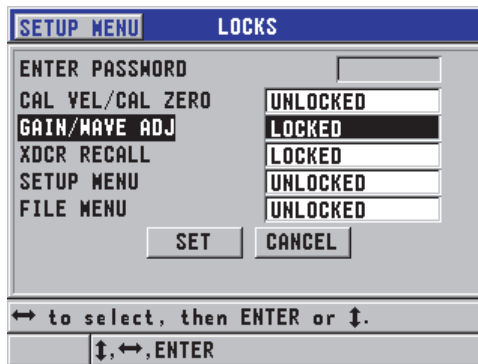

Figure 7-10 The LOCKS screen

7.6 Freezing the Measurement or Optional Waveform

Pressing [FREEZE] stops updating the display and optional waveform, and keeps the waveform and thickness on the display even if you move or uncouple the transducer. The freeze indicator (**F**) appears on the lower right side of the display when the freeze function is active.

The freeze function is convenient for easily setting the gain parameters, reviewing a B-scan, or performing a high-temperature measurement without having to keep the transducer coupled to the test piece.

In order to prevent recording wrong minimum or maximum values, you may also want to use the freeze function to pause measurements before uncoupling the transducer from the test piece.

To freeze the waveform and thickness display

1. Press [FREEZE] while making a measurement.
2. Press [FREEZE] again to unfreeze the waveform and the thickness display.

NOTE

Pressing [MEAS] or [SAVE] (when the Datalogger option has been activated) also unfreezes the display.

8. Configuring the Instrument

This chapter describes how to configure the instrument's measurement, system, and communication parameters.

8.1 Configuring Measurement Parameters

The **MEAS** setup is the most commonly used setup menu screen, and is used to access global parameters concerning the instrument measurement features.

To configure measurement parameters

1. In the measurement screen, press **[SETUP]**, and then select **MEAS**.

NOTE

In the **MEAS** screen, some parameters differ depending on whether a single or dual element transducer is connected (see Figure 8-1 on page 150).

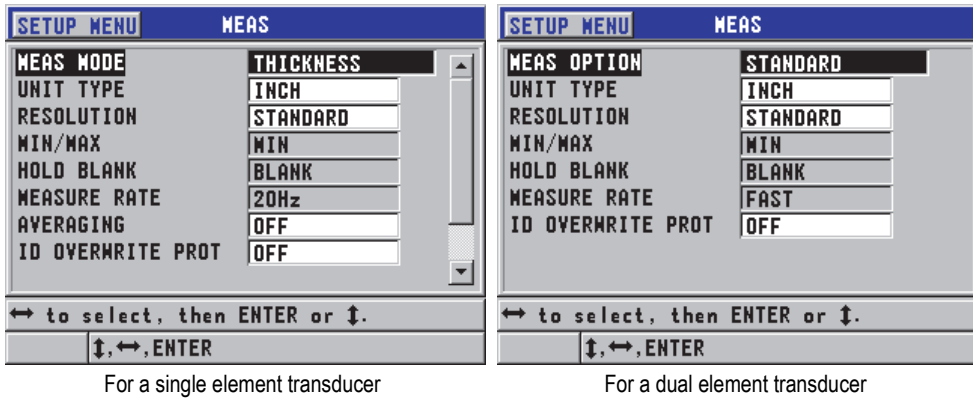

Figure 8-1 The MEAS screen

2. In the **MEAS** screen for single element transducers, in the **MEAS MODE** text box, select the instrument measures and displays from the following options:
 - **THICKNESS**: The thickness of the inspected part.
 - **VELOCIMETER**: The sound velocity in the material of the inspected part.
 - **TIME OF FLIGHT**: The round trip time of flight (TOF) of the sound in the inspected part

OR

In the **MEAS** screen for dual element transducers, in the **MEAS OPTION** text box, select the measurement method to be used by the instrument from the following options:

 - **STANDARD**: Measure to the first back-wall echo.
 - **AUTO ECHO-TO-ECHO** (optional): Measure between the successive back-wall echoes.
 - **MANUAL ECHO-TO-ECHO** (optional with the Waveform): Measure between the multiple back-wall echoes with the manual control.
3. In the **UNIT TYPE** text box, select between the **INCH** (English) or **MILLIMETER** (metric) units.
Time-of-flight measurements are always expressed in microseconds.
4. In the **RESOLUTION** text box, select between **STANDARD**, **LOW**, or **HIGH** (see “Changing the Thickness Resolution” on page 60 for details).

5. In the **MIN/MAX** text box, select either **MIN** (minimum), **MAX** (maximum), or **BOTH** to activate a mode (see “Using the Minimum, Maximum, or Min/Max Thickness Mode” on page 139 for details).
6. In the **HOLD BLANK** text box, configure the instrument to either continue to show (**HOLD**), or not hold (**BLANK**) the last measured thickness and waveform while a loss of signal (LOS) occurs.

NOTE

The **MIN/MAX** and **HOLD BLANK** functions are mutually exclusive. You must set **MIN/MAX** to **OFF** in order to change the **HOLD BLANK** function. Similarly, you must set **HOLD BLANK** to **BLANK** in order to change the **MIN/MAX** function.

-
7. In **MEASURE RATE**, adjust the measurement update rate (see “Adjusting the Measurement Update Rate” on page 58 for details).
 8. For single element transducers only, set **AVERAGING** to **OFF** in order to turn thickness averaging off, set **AVERAGING** to **ON** to perform a running average of the last five thickness readings, or set **AVERAGING** to **On-QBar** to display a quality measurement Q-bar below the measurement screen, indicating the stability of the averaged reading.
 9. Set **ID OVERWRITE PROT** to **ON** (with the Datalogger option only) if you want to see a confirmation message in the help bar when attempting to save a measurement reading in an ID that already contains a value (see “Setting the ID Overwrite Protection” on page 125 for details).
 10. For single element transducers only, set **QUICK SETUP RECALL** to **ON** in order to activate the quick recall of the first four custom setups by using a combination of the [2nd F] and arrow keys (see “Quickly Recalling a Custom Setup for Single Element Transducers” on page 192 for details).
 11. For single element transducers only, set **AGC** to **ON** to configure the automatic gain control (AGC) function to automatically bring all measured back-wall echoes to the same amplitude.

TIP

The AGC function works well for most standard thickness gauge applications, and is turned on by default. In some thickness applications, the receiver gain is set at or near its maximum value. In such cases, turn off the AGC function to prevent reading instability.

- Press **[MEAS]** to return to the measurement screen.

8.2 Configuring System Parameters

The **SYSTEM** screen, allows you to configure many 45MG system parameters.

To configure system parameters

- In the measurement screen, press **[SETUP]**, and then select **SYSTEM**. The **SYSTEM** screen appears (see Figure 8-2 on page 152).

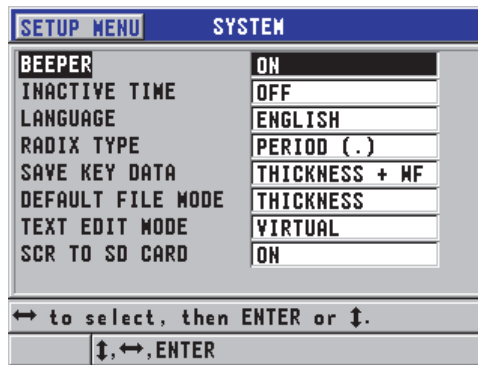

Figure 8-2 The **SYSTEM** screen

- Set **BEEPER** to **ON** or **OFF** (see “Setting the User Interface Language and Other System Options” on page 53 for details).
- Set **INACTIVE TIME** to **ON** or **OFF** (see “Setting the User Interface Language and Other System Options” on page 53 for details).
- In the **LANGUAGE** text box, select the desired user interface language (see “Setting the User Interface Language and Other System Options” on page 53 for details).
- Set **RADIX TYPE** to the desired character (period or comma) for separation of the integer and decimal numbers.
- Set **SAVE KEY DATA** to save only the thickness measurement (**THICKNESS**), or both the thickness and the waveform (**THICKNESS + WF**).

NOTE

The calibration and setup parameters are also always saved/sent along with the thickness measurement.

7. Set **DEFAULT FILE MODE** to the desired default file data mode when you create a file (see “File Data Modes” on page 114 for details).
8. Set **TEXT EDIT MODE** to the appropriate option for entering alphanumeric values. The two available options are the virtual keyboard (**VIRTUAL**) and the legacy character wheel selection (**TRADITIONAL**) [see “Selecting the Text Edit Mode” on page 49 for details].
9. Set **SCR TO SD CARD** to **ON** to enable the 45MG to create a BMP image file on the external microSD card for the actual screenshot when you press [**2nd F**], [**SETUP**] (see “Sending a Screen Capture to the External microSD Card” on page 202 for details).
10. Press [**MEAS**] to return to the measurement screen.

8.3 Configuring Communications

The 45MG features a USB port that can be used to connect the instrument to a computer. When connected to a computer, the 45MG can send and receive data, or be remotely controlled by the computer (when the Datalogger option has been activated). The remote command document and the FTP (file transfer protocol) document are available upon request.

Select the communication parameters you want to use.

To configure the communication parameters

1. In the measurement screen, press [**SETUP**], and then select **COMM**.
2. In the **COMM** screen (see Figure 8-3 on page 155):
 - a) In **COMM PROTOCOL**, select the remote command set to be used by the instrument for communication:
 - **MULTI CHAR**: Multi character commands that are used for communication with a computer running the GaugeView interface program.

- **SINGLE CHAR:** Single character command is normally used when an external program is controlling the instrument by sending remote commands that mimic keystrokes.
- b) In **OUTPUT FORMAT**, select the format of the data being output (**F1, F2, F3,...F10**).

NOTE

Contact Evident for more information on the following communication parameters:

- Multi and single character remote commands.
- Send formats (F1, F2, F3, F4, F5, F6, F7, F8, F9, and F10).

-
- c) Set **B-SCAN OUTPUT** to **ON** to output the B-scan data when communicating with the GaugeView interface program. Set it to **OFF** when communicating with other interface programs that do not support the B-scan data. This parameter only applies to files that have stored B-scan images.
 - d) Set **FTP OUTPUT** to **45MG** in order to use the 45MG file protocol.
OR
Set **FTP OUTPUT** to **38DLP** in order to use the 38DL PLUS file protocol.
OR
Set **FTP OUTPUT** to **MG2** to use the MG2 file protocol.
 - e) Set **OUTPUT TYPE** to **FTP** for communication with the GaugeView software using the standard file transfer protocol.
OR
Set **OUTPUT TYPE** to **CSV** to output in a generic comma-separated variables (CSV) format, which can be integrated into custom software.

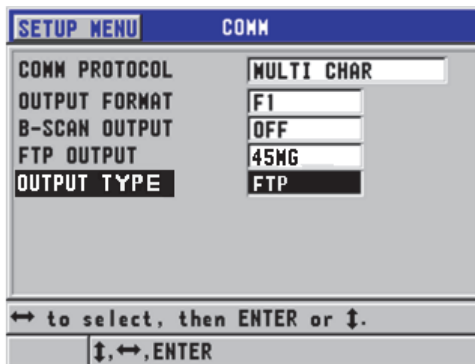

Figure 8-3 The COMM screen

9. Using Advanced Gaging Features

The 45MG has many advanced thickness-measurement features that contribute to making the gauge a more versatile instrument, including gain, extended blank, B-Scan, and DB Grid.

9.1 Adjusting the Gain with Dual Element Transducers

With D79X series dual element transducers, you can manually adjust the gain by pressing **[GAIN/WAVE ADJ]**. The 45MG offers two types of gain adjustments:

- The standard feature allows the user to set the gain to **HIGH** (+10 dB), standard (default), and **LOW** (–6 dB).
- When the waveform (option) is activated, the user can adjust the gain in 1 dB increments.

The gain value is expressed in decibels (dB), and appears near the lower-right corner of the display (see Figure 9-1 on page 158).

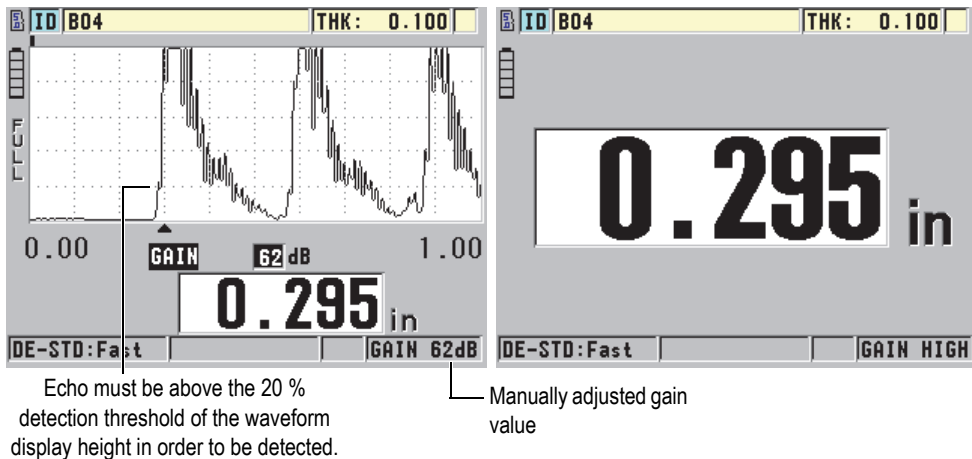

Figure 9-1 Manually adjusting the gain

When activated, the manual gain adjustment also modifies the way in which echoes are shown on the waveform display (optional). With the default automatic gain, the measured echo peak is visible on the display, enabling you to readily observe the measured echo position, independent of its strength or the gain. When you manually adjust the gain, the displayed echo height changes proportionally to the actual echo amplitude at the receiver output, enabling you to readily observe gain changes.

To be processed for thickness calculation, the peak amplitude of measured echoes must be at or above the threshold.

To view, restore, or change the gain value

When the optional waveform is not activated:

1. Press [**GAIN/WAVE ADJ**] to change the gain from default gain to **HIGH** (+10 dB).
2. Press [**GAIN/WAVE ADJ**] again to change the gain to **LOW** (-6 dB).
3. Press [**GAIN/WAVE ADJ**] a third time to change the gain back to default gain (no gain showing).

When the optional waveform is activated:

1. Press [**GAIN/WAVE ADJ**] to view the current automatic gain value.

The gain value appears near the lower-right corner of the display. The waveform display changes to the amplitude proportional to the gain mode.

2. Press [**◀**] or [**▶**] to adjust the gain in ± 1 dB steps.

The gain value and the height of the echoes change accordingly.

- Increase the gain value when the peak amplitude of the echo that should be detected is below 20 % of the waveform display height.

This prevents the gauge from reading too high a value when skipping one back-wall echo, and from measuring twice the correct thickness (doubling).

- Reduce the gain value when noise peaks are above 20 % of the waveform display height.

This prevents the gauge from detecting a noise peak rather than the correct back-wall echo.

3. Press [**2nd F**], [**GAIN/WAVE ADJ**] again to restore the default gain value.

4. Press [**GAIN/WAVE ADJ**] again to return to the automatically adjusted echo height mode.

The default automatic gain mode is indicated by a blank **Gain** field.

9.2 Adjusting the Extended Blank with Dual Element Transducers



CAUTION

Evident recommends using the extended blank parameter only if you are an experienced operator who thoroughly understands the acoustic properties of the material being measured. Incorrect use of the extended blank can cause the gauge to misread areas of thin material.

Normally, the 45MG searches for echoes down to nearly zero thickness. However, some special circumstances, such as a high degree of near-surface corrosion, aluminum material, enclosed flaws, or laminations, can generate echoes that the instrument may falsely detect as the low thickness. When these echoes are larger than the sought after back-wall echo, the manual gain adjustment (see “Adjusting the Gain with Dual Element Transducers” on page 157) cannot prevent this false detection. However, the extended blank parameter allows you to define an early period, during which the 45MG will not perform echo detection, thereby preventing erroneous measurements.

To use the extended blank

1. Press **[GAIN/WAVE ADJ]** (only available when the waveform is active).
The waveform adjustment parameter and its value appear on the measurement screen (see Figure 9-2 on page 160).
2. If needed, use the **[▲]** and **[▼]** keys to select **EXT BLANK**.
The extended blank becomes active, but initially, its value is zero. The gauge remains in the measurement screen.
3. Use the **[▶]** or **[◀]** keys respectively to increase or decrease the blank value until early unwanted echoes are excluded from detection.
The extended blank horizontal bar just above the waveform display indicates the extended blank length (see Figure 9-2 on page 160).

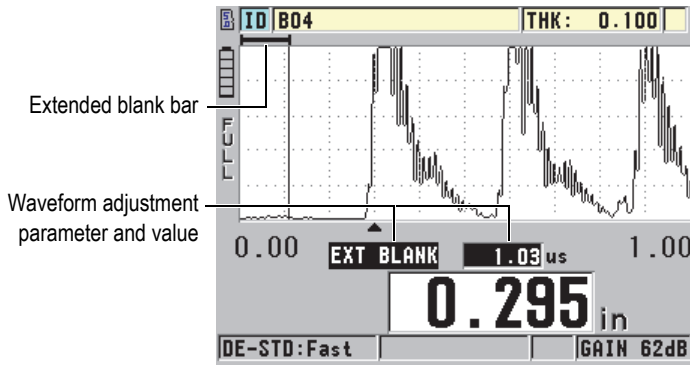

Figure 9-2 Adjusting the extended blank length

4. To turn off the extended blank, use the **[◀]** key to bring the extended blank value back down to zero.

NOTE

If the measurement point changes when the extended blank is moved, echoes can change in height. This is because in the normal waveform display mode, the 45MG attempts to adjust the height.

The instrument also attempts to make the most accurate measurement by identifying the beginning of an echo. When the extended blank is positioned within an echo instead of to its left, the gauge is unable to make an accurate detection.

9.3 B-Scan

A B-scan is a cross-sectional image of thickness readings. The 45MG can acquire and display B-scan data (see Figure 9-3 on page 161). When you activate the B-scan, the thickness reading profile builds up and scrolls on the screen. Once a B-scan is acquired, you can freeze the screen and review the recorded thickness values.

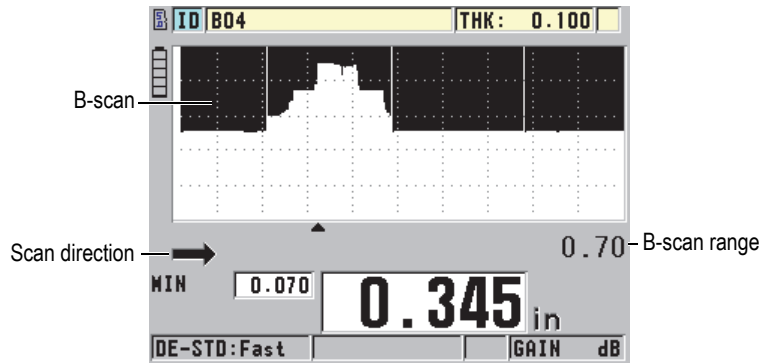

Figure 9-3 B-scan example

While the B-scan is running, you can save individual thickness readings, the current B-scan screen (with all thickness values), or the entire scan (up to 10000 readings) [see “Saving B-Scans or Thickness Readings (Optional Datalogger)” on page 165].

The B-scan can be actively configured from the **B-SCAN** screen (see Figure 9-4 on page 162), which is accessible by pressing [SETUP], and then selecting **B-SCAN** in the menu.

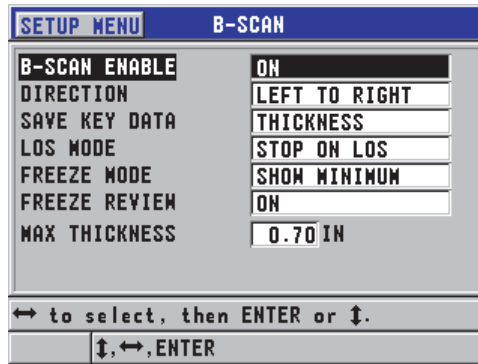

Figure 9-4 Changing B-scan parameters

The **B-SCAN** screen contains the following parameters:

DIRECTION:

Choose the B-scan direction to match the direction of transducer movement. A scan direction arrow appears below the left corner of the B-scan display to indicate the transducer scan direction (see Figure 9-5 on page 162). The data starts appearing on-screen in the opposite direction.

LEFT TO RIGHT

The transducer scans the part from left to right, and the data appears on the right of the screen, scrolling right to left.

RIGHT TO LEFT

The transducer scans the part from right to left, and the data appears on the left of the screen, scrolling left to right.

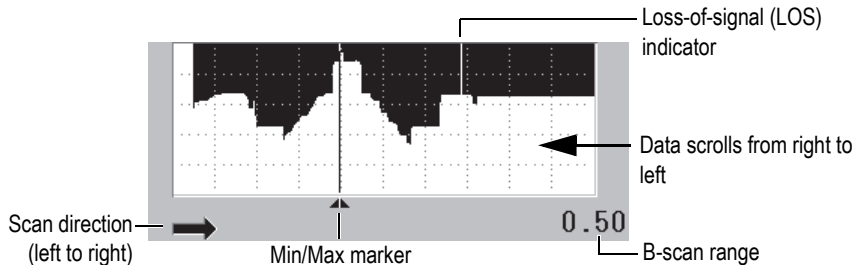

Figure 9-5 B-scan elements

LOS MODE

Determines how the B-scan behaves when a loss of signal (LOS) occurs.

STOP ON LOS

The B-scan stops scrolling when an LOS occurs. When the instrument regains the measurements, a thin blank vertical line is inserted into the B-scan to indicate that an LOS has occurred (see Figure 9-5 on page 162).

CONTINUE ON LOS

The B-scan continues scrolling when an LOS occurs.

FREEZE MODE

Determines which thickness readings are displayed when **[FREEZE]** is pressed while a B-scan is active.

SHOW MINIMUM

Displays the thickness reading for the minimum reading collected during the scan.

SHOW MAXIMUM

Displays the thickness reading for the maximum reading collected during the scan.

SHOW CURRENT

Displays the last thickness reading made before pressing **[FREEZE]**.

FREEZE REVIEW

When this feature is enabled and a B-scan is active, pressing **[FREEZE]** freezes the B-scan image in review mode. In this mode, a vertical line (review marker) appears, indicating the location of the displayed thickness (see Figure 9-6 on page 164). The displayed thickness is either the minimum, maximum, or current thickness, depending on which **B-SCAN FREEZE MODE** option is selected. Use the **[◀]** and **[▶]** keys to move the review marker and read the thickness at the review marker location.

TIP

If the minimum or maximum value moves off the B-scan screen, press **[FREEZE]** to center the B-scan and the review marker on the minimum or maximum thickness.

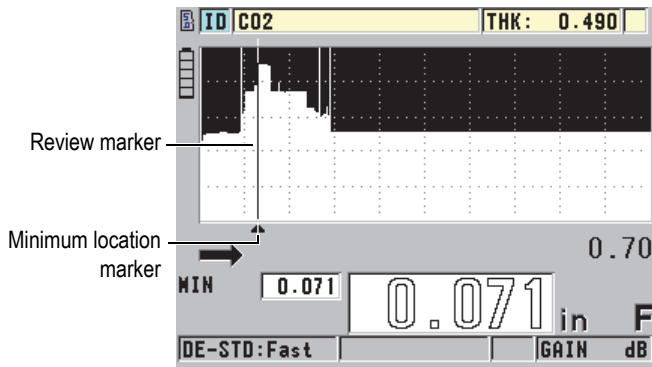

Figure 9-6 B-scan freeze review elements

MAX THK MODE:

Determines the vertical scale of the B-scan.

9.3.1 Using the B-Scan

The following procedure describes how to activate and use the B-scan.

To use the B-scan

1. While in the measurement screen, press [SETUP], and then select **B-SCAN**.
2. In the **B-SCAN** screen, set **B-SCAN ENABLE** to **ON**, and then configure the other B-scan parameter as desired (see “B-Scan” on page 161).
3. Press [MEAS] to return to the measurement screen with the B-scan active.
The B-scan begins drawing the cross section of the material as soon as the first non-LOS reading is collected.
4. To stop the collection of B-scan data:
Press [FREEZE].
OR
With **B-SCAN LOS MODE** set to **STOP ON LOS**, simply uncouple the transducer from the test material.
5. While the B-scan is frozen, if **B-SCAN FREEZE REVIEW** is set to **ON**, use the [◀] and [▶] keys to move the review marker, and then read the thickness value corresponding to the marker position.

6. Press **[MEAS]** again to reset the B-scan and begin a new B-scan.
7. Refer to “Saving B-Scans or Thickness Readings (Optional Datalogger)” on page 165 for details on how to save B-scan data.

9.3.2 Using the B-Scan Alarm Mode

You can specify B-scan low and high alarm reference values, and turn the visual and audible alarm functions **ON** and **OFF**. The B-scan alarm mode is similar to the standard alarm mode (see “Using Alarms” on page 141), except that the alarm lines are shown in the B-scan grid if the alarm reference values fall within the B-scan thickness range. The alarms are also operational as you review B-scan thicknesses in review mode within a frozen B-scan.

To use the B-scan alarm mode

1. Activate and configure the B-scan (see “Using the B-Scan” on page 164).
2. While in the measurement screen, press **[SETUP]**, and then select **ALARM**.
3. In the **ALARM** screen (see Figure 7-7 on page 145):
 - a) Set **ALARM ENABLE** to **ON**.
 - b) Set **ALARM MODE** to **B-SCAN**.
 - c) Enter the desired **LOW ALARM** and **HIGH ALARM** values.
4. Press **[MEAS]** to return to the measurement screen.
5. The horizontal red alarm lines appear on the B-scan (see Figure 7-5 on page 143).

9.3.3 Saving B-Scans or Thickness Readings (Optional Datalogger)

The 45MG is capable of performing the following tasks while the B-scan is in use:

- Save a live thickness reading while the B-scan is running.
- Save any reviewed thickness reading on a frozen B-scan.
- Save all thickness readings for one B-scan screen, along with the minimum or maximum thickness readings for a held B-scan.
- Save an entire B-scan history of up to 10000 thickness readings, the minimum or maximum thickness readings, and the held B-scan.

To save a live thickness reading while the B-scan is running

- ◆ Press **[SAVE]**.

To save any reviewed thickness reading on a frozen B-scan

1. While the B-scan is running, press **[FREEZE]** to enter the review mode.
2. Use the **[◀]** and **[▶]** keys to review any thickness on the frozen B-scan.
3. Press **[SAVE]** to save the thickness value for the review marker position to the datalogger.

To save the minimum or maximum thickness reading for a frozen B-scan

1. Set **B-SCAN FREEZE MODE** to **SHOW MINIMUM** or **SHOW MAXIMUM**. The gauge displays the minimum or maximum thickness reading with the corresponding waveform.
2. While the B-scan is running, press **[FREEZE]** to enter the review mode.
3. Press **[SAVE]** while the minimum or maximum thickness reading is displayed.

To save the entire B-scan (B-scan history)

1. In the **B-SCAN** screen (see Figure 9-4 on page 162), set **SAVE KEY DATA** to **THK + B-SCAN**.
2. While the B-scan is running, or when it is frozen, press **[SAVE]**. The **Save B-Scan history?** message appears on the help text bar.
3. Select **Yes** to save the entire B-scan history, including the Minimum or Maximum thickness with the corresponding waveforms.
OR
Select **No** to save the current B-scan screen and the waveform.

NOTE

When a B-scan screen is saved to the datalogger, the gauge saves the thickness values for the data points appearing on the display. All thickness values on a saved B-scan can be reviewed during ID Review. Recall the saved B-scan, and use the **[◀]** and **[▶]** keys to review each thickness reading.

NOTE

You can save a maximum of 10000 thickness readings to a B-scan. When the maximum number of thickness points reaches 10000, the gauge prompts you to save the B-scan history, or to reset the B-scan without saving.

9.4 DB Grid

The database grid (DB grid) is a table representation of 2-D data. This representation enables you to move freely in any direction on a grid, rather than follow a preset list of IDs. Instead of automatically incrementing to the next ID location, you can use the arrow keys to move to a location that is more convenient. You can simultaneously display the A-scan, the DB grid, and the thickness reading (see Figure 9-7 on page 167). You can configure the grid cells to show a data cell flag and a background color corresponding to the range in which their thickness reading falls.

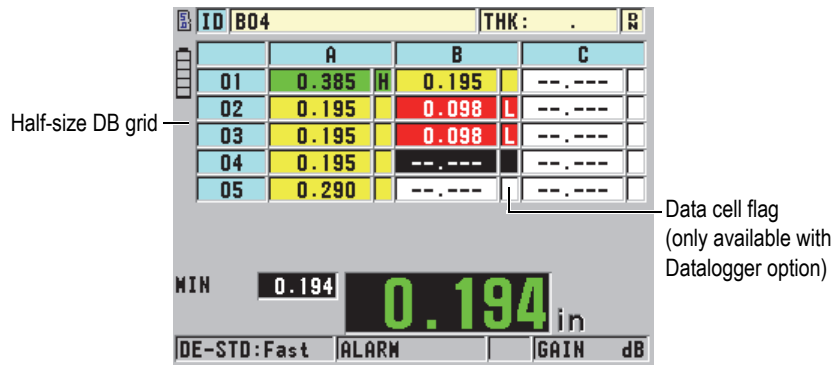

Figure 9-7 Example of the half-size DB grid

9.4.1 Activating and Configuring the DB Grid

Activate and configure the DB grid options from the **DB GRID** screen.

To activate and configure the DB grid

1. In the measurement screen, press [SETUP], and then select **DB GRID**.
2. In the **DB GRID** screen (see Figure 9-8 on page 168), perform the following steps.

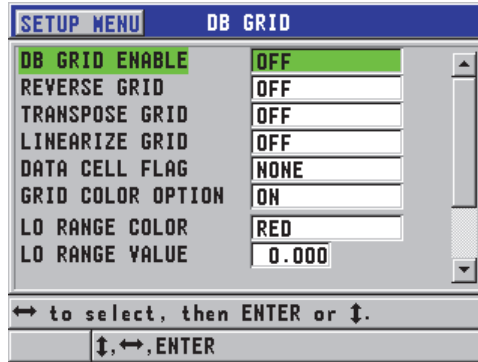

Figure 9-8 Changing DB grid parameters

3. Set **DB GRID ENABLE** to **ON** to activate the DB grid.
4. Set **TRANPOSE GRID** to **ON** to interchange the rows and columns in a grid (see Figure 9-9 on page 168).

TRANPOSE GRID set to OFF					TRANPOSE GRID set to ON				
	A	B	C	D		01	02	03	04
01	---	---	---	---	A	---	---	---	---
02	---	---	---	---	B	---	---	---	---
03	---	---	---	---	C	---	---	---	---
04	---	---	---	---	D	---	---	---	---

Figure 9-9 Grid transposition example

NOTE

The ID number increments in the order assigned when the file was initially set up independent of the TRANPOSE GRID value.

5. Set **LINEARIZE GRID** to **ON** to display the grid IDs in the linear form (see Figure 9-10 on page 169).

ID	THICKNESS
A01	---.---
A02	---.---
A03	---.---
A04	---.---

Figure 9-10 Example of a linearized DB grid

- Set **DATA CELL FLAG** to one of the available options in order to display a single data flag with each data cell in the DB grid. The data cell flag is a letter that appears in a small box to the right of the thickness value in the data cell (see Figure 9-7 on page 167). The available options are:

NONE

No data cell flag appears.

MIN/MAX

“m” indicates a minimum thickness.

“M” indicates a maximum thickness.

ALARM

“L” indicates any kind of low alarm condition, including a standard low alarm condition.

“H” indicates any high alarm condition.

- Set **GRID COLOR OPTION** to **ON** to activate usage of low, mid, and high-range colors for the grid cell background.
- Set **LO RANGE COLOR** to the desired cell background color (**RED**, **YELLOW**, or **GREEN**) when the cell thickness value is smaller than the **LO RANGE VALUE**.
- Set **MID RANGE COLOR** to the desired cell background color (**RED**, **YELLOW**, or **GREEN**) when the cell thickness value is between the **LO RANGE VALUE** and the **HI RANGE VALUE**.
- Set **HI RANGE COLOR** to the desired cell background color (**RED**, **YELLOW**, or **GREEN**) when the cell thickness value is higher than the **HI RANGE VALUE**.

9.4.2 Changing the Highlighted Cell in the DB Grid

Use the arrow keys to easily move the selected cell in the DB grid.

To change the highlighted cell in the DB grid

- Activate and configure the DB grid (see “Activating and Configuring the DB Grid” on page 167).

2. In the measurement screen, press **[2nd F]**, **[FILE]** (**ID#**).
3. In the ID review screen (see Figure 9-11 on page 170):
 - a) Use the **[▲]**, **[▼]**, **[◀]**, and **[▶]** keys to highlight the desired grid cell.
 - b) Press **[2nd F]**, **[▲]** to jump to the last ID location in the file.
 - c) Press **[2nd F]**, **[▼]** to jump to the first ID location in the file.
 - d) Press **[ID#]** at any time to edit the displayed ID location.

ID	C02	THK: 0.489IN		
		B	C	D
01		0.296	0.489	---.---
02		0.294	0.489	---.---
03		0.099	---.---	---.---
04		0.294	---.---	---.---

ID REVIEW

DE-STD	ALARM HIGH	GAIN	dB
↓, 2nd F ↓ to select, or ID# to edit ID.			
↓, 2nd F ↓, ID#			

Figure 9-11 The highlighted DB grid cell in the ID review screen

4. Press **[MEAS]** to return to the measurement screen with the current ID number changed to the ID location selected in the ID review screen.

9.4.3 Saving Thickness Readings in the DB Grid

To save thickness readings in the DB grid

1. Activate and configure the DB grid (see “Activating and Configuring the DB Grid” on page 167).
2. Move to the desired DB grid cell (see “Changing the Highlighted Cell in the DB Grid” on page 169).
3. In the measurement screen, while the thickness value is displayed, press **[SAVE]** to save the thickness.

The displayed thickness value and setup information are stored at the current ID location identified by the highlighted cell in the grid. If the thickness display is

blank when you press [SAVE] (Datalogger option only), then "--.---" is saved in place of a value.

The ID number is automatically updated to the next ID number in the sequence. The new ID number is indicated on the ID bar, and its cell is highlighted in the grid. If the ID number cannot be updated, a long beep sound is emitted and the instrument displays a message indicating why the ID was unable to update. In this case, the ID number on the display remains unchanged.

9.4.4 Viewing an Inserted or an Appended Cell in the DB Grid

It is possible to insert or append a cell in the DB grid. To maintain the format of the grid, the inserted or appended cell does not appear until you are on the cell with the inserted point. The file will automatically change to the linear form, and then return back to Grid view when you increment to the next grid location (see Figure 9-12 on page 171).

	01	02	03	04
A	0.104 L	--.---	0.202	--.---
B	0.199	--.---	--.---	--.---
C	0.295	--.---	--.---	--.---
D	0.402	--.---	--.---	--.---

Cell with an inserted or appended cell

Figure 9-12 Example of an inserted cell

To view an inserted or an appended cell in the DB grid

1. Activate and configure the DB grid (see "Activating and Configuring the DB Grid" on page 167).
2. Press [2nd F], [FILE] (ID#), and then use the arrow keys to move to the desired shaded grid cell.
3. Press [ENTER] to change the grid to a linear view, following which the inserted or appended ID number is displayed (see Figure 9-13 on page 171).
4. Press [ENTER] again to return to the normal DB grid view.

	ID	THICKNESS
	01A	0.104 L
	01B	0.199
Inserted cell	01BB	0.200
	01C	0.295

Figure 9-13 Example of a zoomed inserted cell

10. Custom Setups for Single Element Transducers

Once the Single Element High Resolution option has been activated, the 45MG includes predefined setups for standard single element transducers. In some cases, a 45MG ships from the factory preprogrammed with one or more custom setups to meet special customer requirements. You can create your own custom setups to meet the need of a particular single element transducer, or for a particular application. Predefined and custom setups allow you to quickly change between transducer and application setups by selecting a previously saved setup.

10.1 Creating a Custom Setup for a Single Element Transducer

A custom setup should be created when the measurement requirements of a particular application are not optimally met by one of the standard setups. Once the adjustments are made, you can name and store this setup in one of the 35 user-defined setup locations.



CAUTION

The adjustments described in the following procedure and subsections should be made only by a qualified technician who is familiar with the basic theory of ultrasonic gaging and the interpretation of ultrasonic waveforms.

Many of the adjustments that can be made in a setup are interactive. All adjustments have an effect on the measurement range and/or measurement accuracy of the 45MG. In most cases, do not attempt adjustments without monitoring the waveform.

Additionally, when establishing a custom setup for a specific application, it is essential to verify the performance on reference standards representing the materials and thickness range to be measured.

To create a custom setup for a single element transducer

1. Connect the single element transducer to the 45MG (see “Setting Up the Transducer” on page 61).
2. Press [2nd F], [FREEZE] (XDCR RECALL).
3. In the menu, select the **CUSTOM SINGLE ELEMENT**.
4. In the **CUSTOM SINGLE ELEMENT** screen, select the desired custom setup location (**SE-USER-n**) in which you want to save the custom setup.

TIP

To reduce the number of changes needing to be made to parameter values, you can also select an existing single element setup with parameter values that are close to the desired setup.

5. In the **ACTIVE** screen (see Figure 10-1 on page 174):
 - a) Set **DET MODE** to the desired detection mode (see “Detection Modes” on page 177 for details).

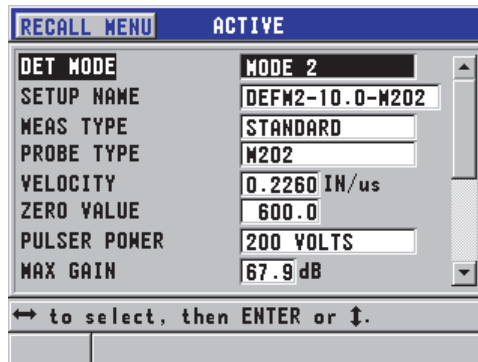

Figure 10-1 The **ACTIVE** screen for the setup of a single element transducer

-
- b) Enter a **SETUP NAME** that describes the transducer and/or the application to be used to create the setup.
 - c) Set **MEAS TYPE** to the desired measurement type. The available choices are:
 - **STANDARD**: For normal mode 1, 2, or 3 positive or negative peak measurement.
 - **FIRST PEAK**: For detection of the first of several peaks of similar amplitudes (see “First Peak” on page 179 for details).
 - d) Set **PROBE TYPE** to indicate the transducer type to be used with this setup. The selected probe type must match the frequency of the transducer being used for proper pulser/receiver performance.
 - e) Set **VELOCITY** to the value of the sound velocity in the material that is to be tested with this setup (see “Material Sound Velocity and the Zero Calibrations” on page 69).
 - f) Set **ZERO VALUE** to the calibrated zero-offset value (time of flight of the echo that is not traveling through the material) for this transducer (see “Calibrating the Instrument” on page 65).
 - g) If needed, increase the **PULSER POWER** to increase the ultrasound wave penetration in the material. Reduce the value for better near-surface resolution (see “Pulser Power” on page 180 for details).
 - h) Set **MAX GAIN** to the desired maximum gain value (see “Maximum Gain” on page 182 for details).
 - i) Set **INIT GAIN** to the desired initial gain value (see “Initial Gain” on page 183 for details).
 - j) Set **TDG SLOPE** to the desired time-dependent gain slope value (see “TDG Slope” on page 183 for details).
 - k) Set **MB BLANK** to the desired main bang blank time interval (see “Main Bang Blank” on page 183 for details).
 - l) Set **ECHO WINDOW** to the desired time interval (see “Echo Window” on page 185 for details).
 - m) Set **ECHO 1 DETECT** to **-SLOPE** to detect the negative peak of the first echo, or to **+SLOPE** to detect the positive peak of the first echo (see “Detection of Echo 1 and Echo 2” on page 187 for details).
6. Press **[SAVE]**.
 7. In the **SAVE SETUP** screen:
 - a) If needed, in the **SAVE AS** dialog box, edit the setup name.
 - b) In the **SAVE TO** list, select the desired custom setup location in which you want to save the setup.
-

- c) Select **SAVE**.
8. Press **[MEAS]** to return to the measurement screen.
The saved setup becomes the active setup.

10.2 Quickly Adjusting Waveform Parameters For Single Element Transducers

With single element transducers, you can quickly adjust individual waveform parameters using the **[GAIN/WAVE ADJ]** key.

To quickly adjust individual waveform parameters

1. Ensure that a single element transducer is connected to the 45MG.
2. In the measurement screen, press **[GAIN/WAVE ADJ]**.
The waveform adjustment parameter appears above the thickness value on the measurement screen (see Figure 10-2 on page 176).

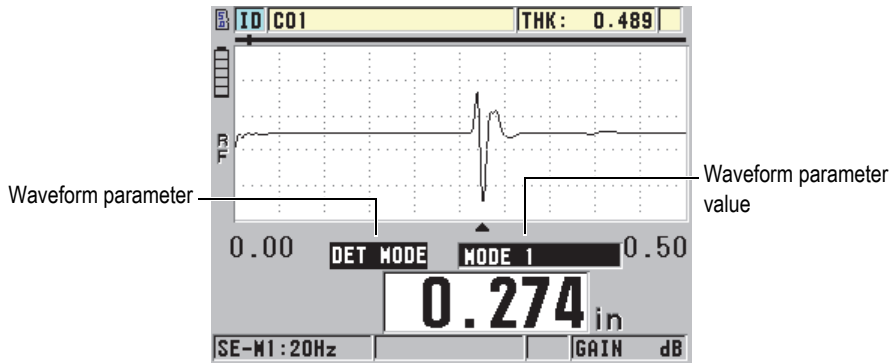

Figure 10-2 Adjusting the waveform parameters

3. Use the **[▲]** or **[▼]** key to select the parameter that you want to adjust. The choices are as follows:
 - **DET MODE** (see “Detection Modes” on page 177 for details)
 - **M3 BLANK** in mode 3 only (see “Mode 3 Echo Blank” on page 190 for details)

- **IF BLANK** in modes 2 and 3 only (see “Interface Blank” on page 188 for details)
 - **ECHO 2 DETECT** in modes 2 and 3 only (see “Detection of Echo 1 and Echo 2” on page 187 for details)
 - **ECHO 1 DETECT** (see “Detection of Echo 1 and Echo 2” on page 187 for details)
 - **ECHO WINDOW** (see “Detection of Echo 1 and Echo 2” on page 187 for details)
 - **MB BLANK** (see “Main Bang Blank” on page 183 for details)
 - **TDG SLOPE** (see “TDG Slope” on page 183 for details)
 - **INIT GAIN** (see “Initial Gain” on page 183 for details)
 - **MAX GAIN** (see “Maximum Gain” on page 182 for details)
 - **PULSER POWER** (see “Pulser Power” on page 180 for details)
 - **PROBE TYPE**
 - **MEAS TYPE** (see step 5.c in “Creating a Custom Setup for a Single Element Transducer” on page 173 for details)
4. Use the [◀] or [▶] keys to select the value for the selected parameter.
 5. Repeat steps 3 and 4 to adjust other parameters.
 6. Press [GAIN/WAVE ADJ] again to hide the waveform adjustment parameter.

10.3 Detection Modes

There are three detection modes (**Mode 1**, **Mode 2**, and **Mode 3**):

Mode 1

Uses a direct contact transducer to measure the time of flight between the main bang and the first back-wall echo (see Figure 10-3 on page 178).

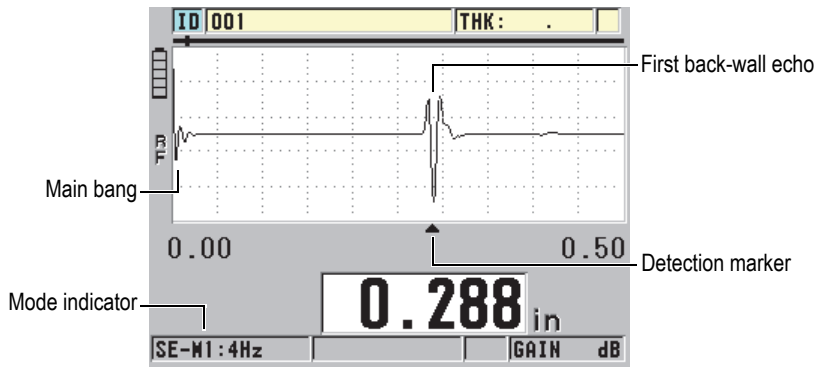

Figure 10-3 Mode 1 detection example

Mode 2

Measures the time of flight between the interface (or delay line) echo and first back-wall echo using a delay line or an immersion transducer (see Figure 10-4 on page 178).

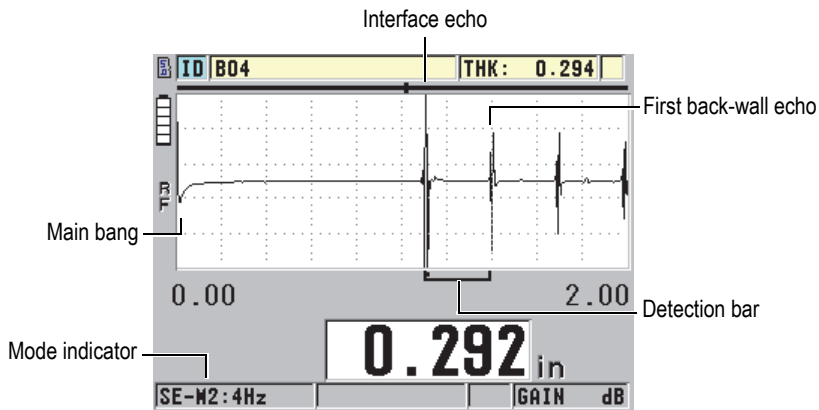

Figure 10-4 Mode 2 detection example

Mode 3

Uses a delay line or an immersion transducer to measure the time of flight between one back-wall echo and the next back-wall echo (see Figure 10-5 on page 179).

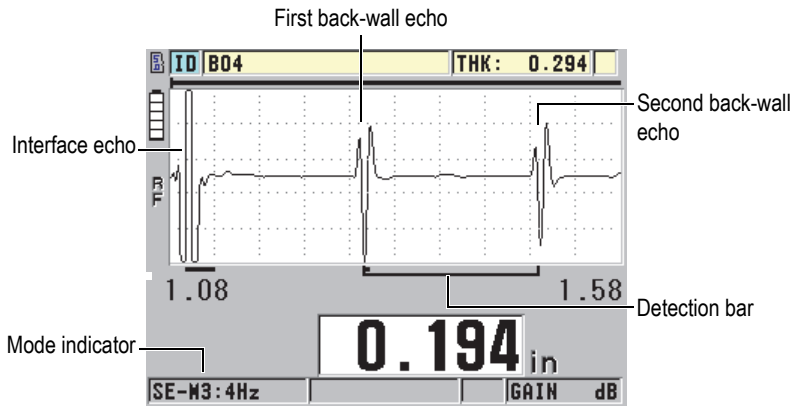

Figure 10-5 Mode 3 detection example

NOTE

Refer to “Echo Window” on page 185 for information on the modes in relation with the echo window.

10.4 First Peak

With single element transducers, the 45MG normally detects peaks on either the highest positive or highest negative peak of the RF waveform. This feature works well for most precision thickness applications.

This normal peak detection can be unstable for applications in which the back-wall echo is irregular and contains several negative or positive peaks that are close in amplitude. In such cases, the thickness reading can fluctuate as the gauge switches detection from one peak to another. This can happen, for example, in applications measuring the length of bolts, or the thickness of the gel coat over fiberglass (see Figure 10-6 on page 180). In such cases, help stabilize the echo detection and thickness measurements by selecting the first peak algorithm to detect the first of several peaks of similar amplitudes (see step 5.c in “Creating a Custom Setup for a Single Element Transducer” on page 173).

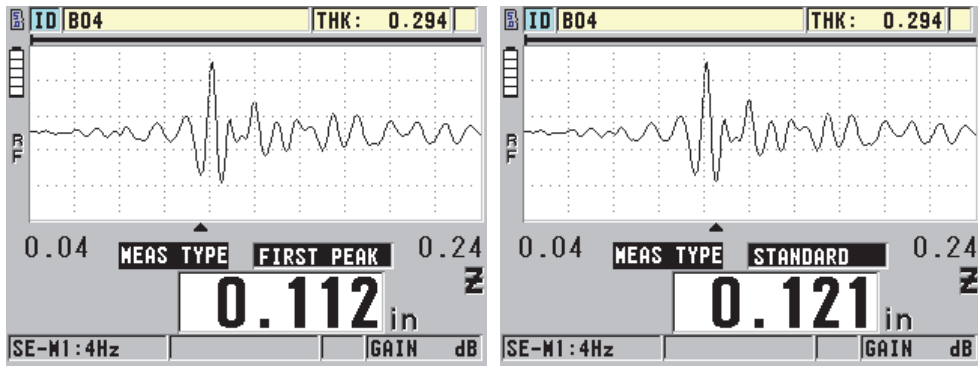

Figure 10-6 Detection of the first or the second negative peak

10.5 Pulsar Power

The excitation pulse (main bang) voltage can be set to one of the following values: 60 V, 110 V, 150 V, and 200 V.

Higher voltages may provide greater penetration at the expense of a lower near-surface resolution, especially in mode 1. Inversely, lower voltages may provide better near-surface resolution at the expense of a lower penetration.

For most applications, the 110 V value provides the best signal-to-noise ratio for returning echoes. The pulsar power indicates the voltage used to excite the transducer, and therefore affects the size of the initial pulse (see Figure 10-7 on page 181), and the amount of energy transmitted into the material.

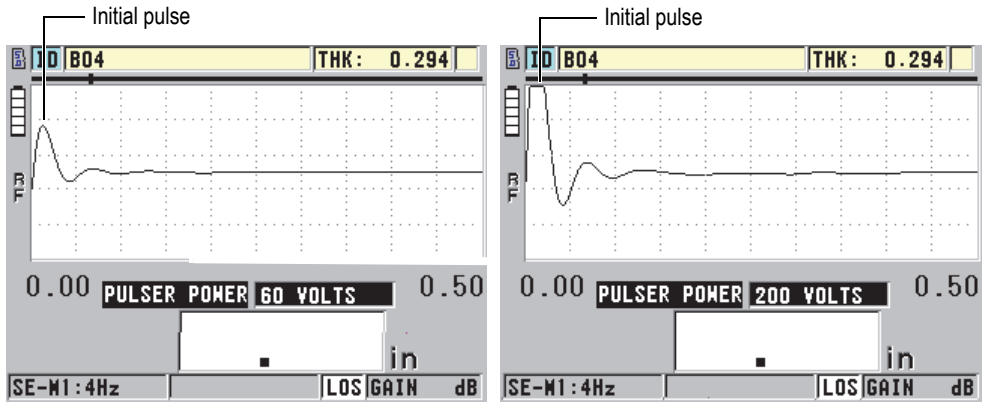

Figure 10-7 Comparing pulser powers set to 60 V and 200 V

NOTE

When the 45MG displays the **SAT** flag below the thickness reading, the input voltage from the transducer is above the maximum range, and proper measurements cannot be made. This can normally be corrected by lowering the **PULSER POWER** until the **SAT** flag no longer appears.

10.6 Time-Dependent Gain Curve

With single element transducers, the 45MG either uses the automatic gain control (AGC) [see “Configuring Measurement Parameters” on page 149 for details on how to activate the AGC] or the time-dependent gain (TDG) functions to automatically adjust receiver gain to an optimum level when an echo is detected.

The 45MG offers three parameters for drawing a time-dependent gain curve: **INIT GAIN**, **TDG SLOPE**, and **MAX GAIN** (see Figure 10-8 on page 182). From the initial gain level, receiver gain slopes up to the maximum gain level at the rate determined by the **TDG SLOPE** setting. When you adjust any of the received gain parameters, a black time-dependent gain curve is displayed that clearly indicates the zones of initial gain, slope, and maximum gain.

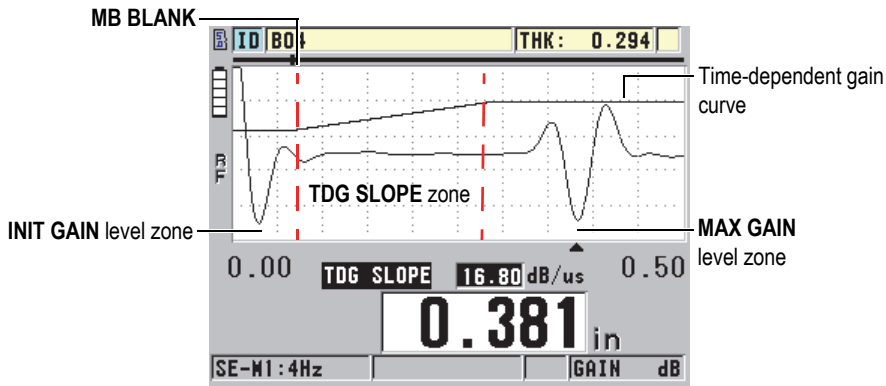

Figure 10-8 The TDG zones and parameters

The TDG curve can be used to optimize near-surface resolution while providing a higher maximum gain for thicker samples. You can also use the TDG curve in measurements of highly scattering materials, such as cast metals and fiberglass, in order to minimize detection of scattered echoes occurring ahead of the back-wall echo.

10.6.1 Maximum Gain

The maximum gain indicates the maximum (time-dependent) receiver gain possible. The maximum gain is used to amplify echoes that are further out in time. In general, for any given application, the maximum gain should be set high enough that all echoes of interest are detected.

The maximum available receiver gain can be adjusted from 0.0 dB to 99.0 dB. When no echo is detected (LOS prompt), the gain rises to the maximum level set by the initial gain, slope, and maximum gain. When the maximum gain is set too high, the gauge may hang up on transducer noise or other spurious signals; when it is set too low, returning echoes may not be high enough for detection.

NOTE

The max gain can never be lower than the initial gain, and has a maximum value of 99.0 dB.

10.6.2 Initial Gain

The initial gain sets an upper limit on receiver gain in the vicinity of the excitation pulse (mode 1) or the interface echo (modes 2 and 3). By effectively making the excitation pulse or interface echo smaller, the TDG curve allows for detection of echoes occurring close to the pulse. The initial gain can be adjusted from 0 dB to the maximum defined by the **MAX GAIN** setting.

The **INIT GAIN** setting is most critical in applications where minimum thickness measurements must be optimized. This setting should always be set with the aid of a reference standard representing that minimum. In cases where the minimum thickness capability is less important than penetration, and scatter echoes are not a problem, the initial gain can be set to be equal to the maximum gain.

The initial gain does the following:

- Indicates the initial (time-dependent) receiver gain currently selected.
- Amplifies echoes that are close to the main bang or interface echoes.
- Starts at time zero and extends to:
 - The main bang blank in mode 1.
 - The end of the interface blank in modes 2 and 3.

10.6.3 TDG Slope

The TDG slope controls the rate at which the receiver gain slopes up from the initial gain level to the maximum gain level. The TDG slope starts at the position of the **MB BLANK** parameter in mode 1, and at the end of the **IF BLANK** parameter in mode 2 and mode 3. The TDG slope helps suppress reflections from grain structure or fibers. Generally, the TDG slope should be set as high as possible in order for it to reach the maximum gain as quickly as possible without causing the gauge to hang up on spurious signals. The slope can be set from 0.0 dB/ μ s to 39.95 dB/ μ s.

10.7 Main Bang Blank

The main bang blank is effectively a blank zone that protects the receiver from false readings generated by the main bang. This blank or dead zone (up to 18 microseconds from the excitation pulse) prevents the trailing edge echoes of the excitation pulse from being detected as back-wall or interface echoes. The end of the main bang blank indicates the point in time at which the gauge begins to search for echoes.

In general, set the main bang blank just beyond the point at which the gauge hangs up, and then proceed to test with the transducer both coupled to and uncoupled from the test material in order to ensure accurate measurements.

In mode 1, however, the length of the main bang blank determines the minimum thickness that can be measured, and must therefore be positioned with care after selecting the initial gain level (see Figure 10-9 on page 184). When the main bang blank is too short, the instrument hangs up on the excitation pulse and readings are not possible. When the main bang blank is too long, the minimum measurable thickness is unnecessarily restricted. When using immersion transducers, ensure that the main bang blank is always set before the interface echo from the shortest water path.

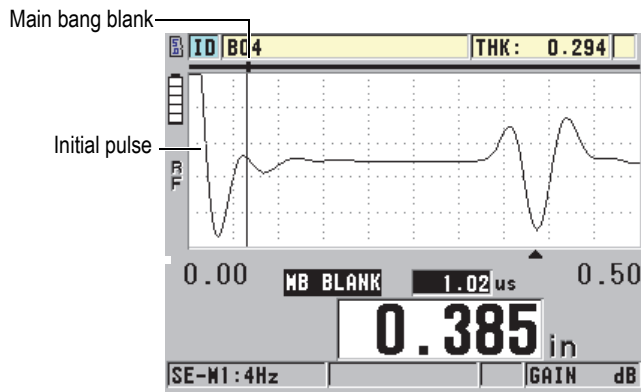

Figure 10-9 Main bang blank position for mode 1

In mode 2 and mode 3, the setting of the main bang blank is not critical if set to some point between the end of the excitation pulse and the interface echo (see Figure 10-10 on page 185).

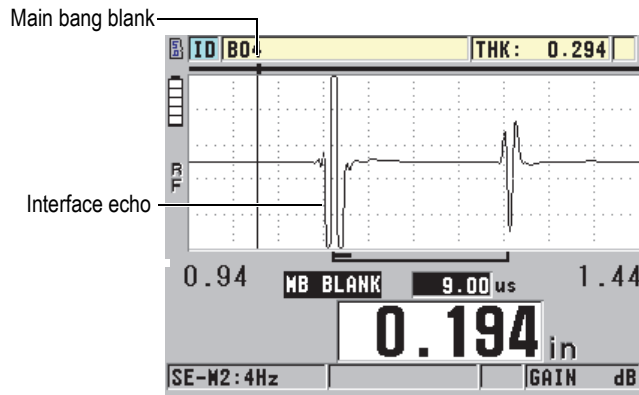

Figure 10-10 Main bang blank position for mode 2 and mode 3

10.8 Echo Window

The echo window is the time interval after each main bang, during which the instrument is enabled to detect echoes. The echo window interval begins at the end of the main bang blank. The echo window ends at x μs following the main bang in mode 1, or at x μs following the interface blank in mode 2 and mode 3.

In mode 1, you can usually set the echo window to any value greater than the round-trip pulse transit time in the thickest or slowest piece of material to be measured (see Figure 10-11 on page 186). The exact setting is not critical as long as it is long enough to include the farthest echo of interest.

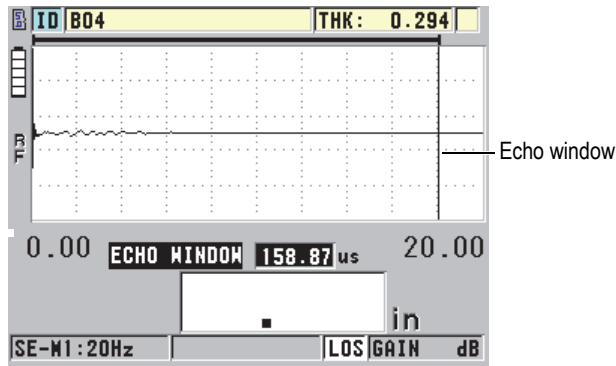

Figure 10-11 Echo window setting for mode 1

In mode 2 and mode 3, the echo window is limited to the time interval between successive interface echoes (see Figure 10-12 on page 186). The end of the echo window must be set ahead of the second interface echo in order to prevent an incorrect detection, which in turn determines a maximum measurable thickness. In applications involving mode 2 and mode 3 immersion measurements, the echo window placement must apply throughout the range of the water paths to be used.

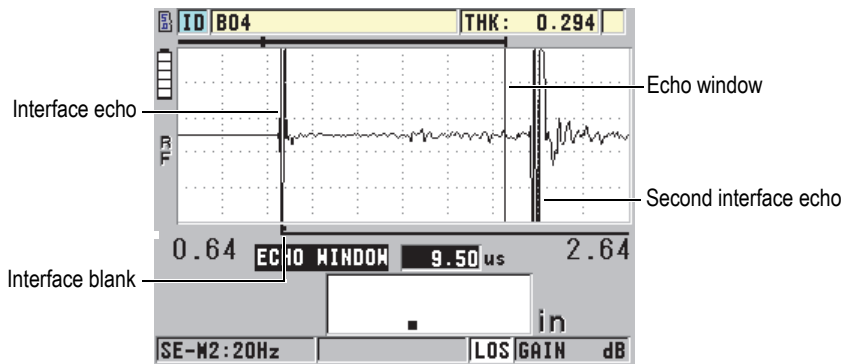

Figure 10-12 Echo window setting for mode 2 and mode 3

10.8.1 Detection of Echo 1 and Echo 2

It is possible to select the detection polarity (positive or negative) for the first and second echoes. Depending on the measurement mode and on the type of test material, the maximum amplitude in an echo can be either a positive or negative peak. Positive and negative polarity refer to processed echoes displayed on the waveform display (see Figure 10-13 on page 187). To measure thicknesses with the highest accuracy, it is important for the 45MG to detect the maximum amplitude peak in an echo.

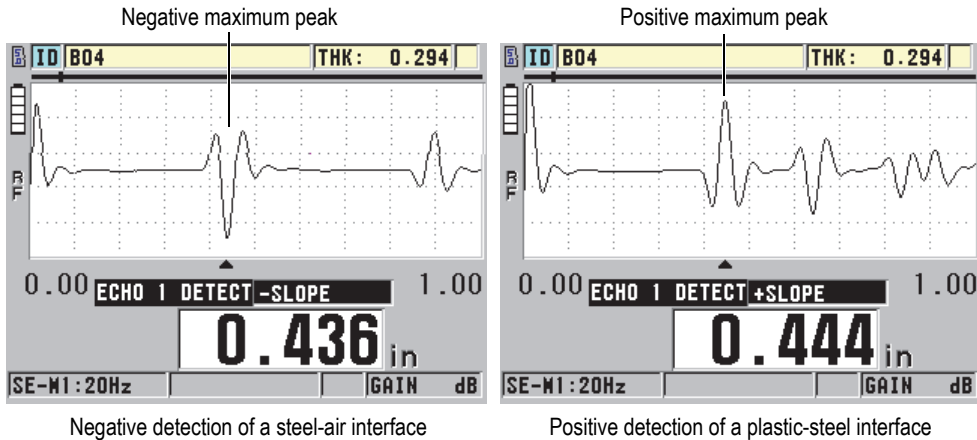

Figure 10-13 Negative and positive echo detection examples

Refer to Table 11 on page 188 for assistance in selecting the appropriate detection polarity for a given application.

Table 11 Polarity of echoes

Measurement mode	Echo 1	Echo 2
Mode 1 using contact transducer	The back-wall echo is normally negative, except when measuring material of low acoustic impedance bonded to a material of high impedance (such as plastic or rubber over metal), where the echo is phase-reversed.	Not applicable
Mode 2 using delay line or immersion transducers	The interface echo is normally positive for high-impedance materials such as metals and ceramics, and negative for low-impedance materials such as most plastics.	The back-wall echo is normally negative, unless the back-wall echo represents the sort of low-to-high impedance boundary.
Mode 3 using delay line or immersion transducers	The interface echo is normally positive for high-impedance materials.	The back-wall echo is normally negative, except in some special cases involving difficult geometries in which phase distortion may cause the positive side of the back-wall echo to be better defined than the negative side.

10.8.2 Interface Blank

The interface blank represents a blank or dead zone up to 20 μs long that follows the leading edge of the interface echo. The interface blank is only available in mode 2 and mode 3.

In mode 2, the interface blank prevents the detection of trailing lobes or cycles of the interface echo which might otherwise be detected as back-wall echoes, which results in a hang-up condition (see Figure 10-14 on page 189). The interface blank should be

set as short as possible to avoid unnecessarily restricting minimum measurable thicknesses. The initial gain parameter often helps reduce the interface echo amplitude, and permits the use of a shorter interface blank. Check the interface blank settings with the transducer both coupled to and uncoupled from the test material.

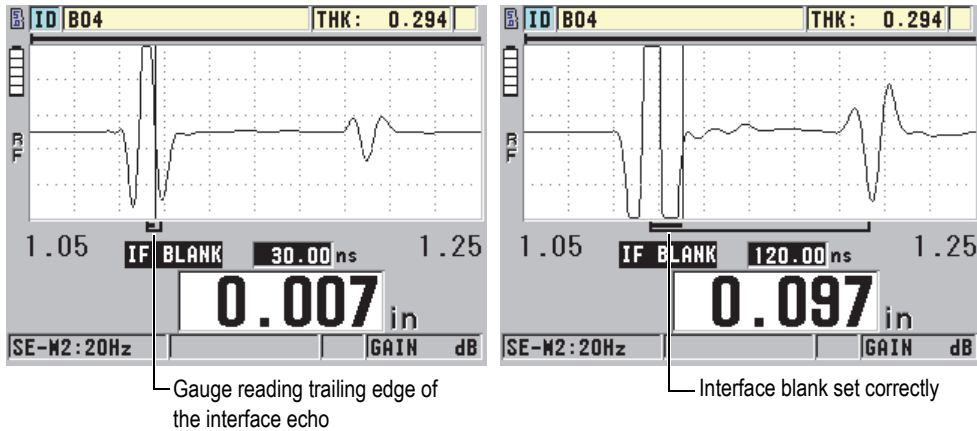

Figure 10-14 Examples of the interface blank in mode 2

In mode 3, the interface blank selects which pair of back-wall echoes are measured (see Figure 10-15 on page 190). In most conditions, the interface blank would be set just short of the first back-wall echo. However, as a practical matter, the first back-wall echo from thin materials is often distorted or lost in the interface echo. With some challenging geometries (such as tight radii), later pairs of back-wall echoes may be cleaner than early ones. In such cases, set the interface blank to a length that ensures detection of a clean and well-defined pair of back-wall echoes, even if the echoes are not the first two.

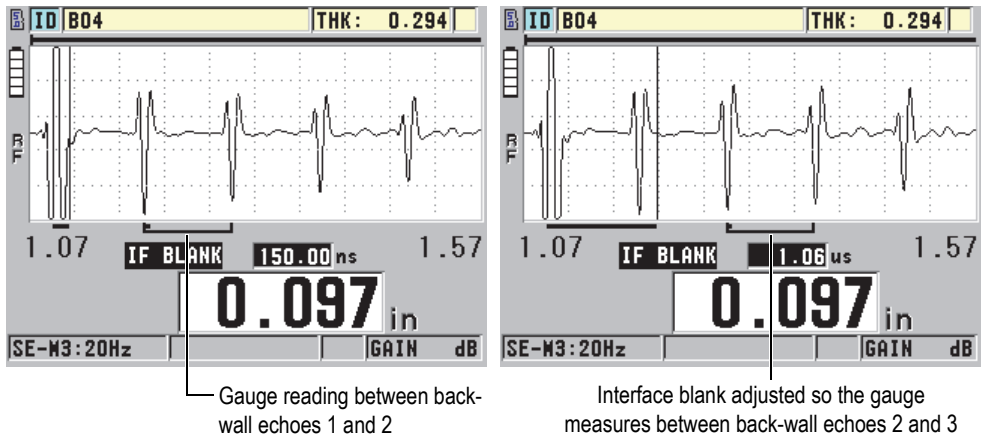

Figure 10-15 Examples of the interface blank in mode 3

10.8.3 Mode 3 Echo Blank

The echo blank in mode 3 (**M3 BLANK**) is similar to the interface blank in mode 2, or to the main bang blank in mode 1. This function creates a blank or dead zone up to 20 μ s long following the leading edge of the first detected back-wall echo in order to prevent detection of trailing lobes or cycles of that echo, and the resulting gauge hang-up (see Figure 10-16 on page 190).

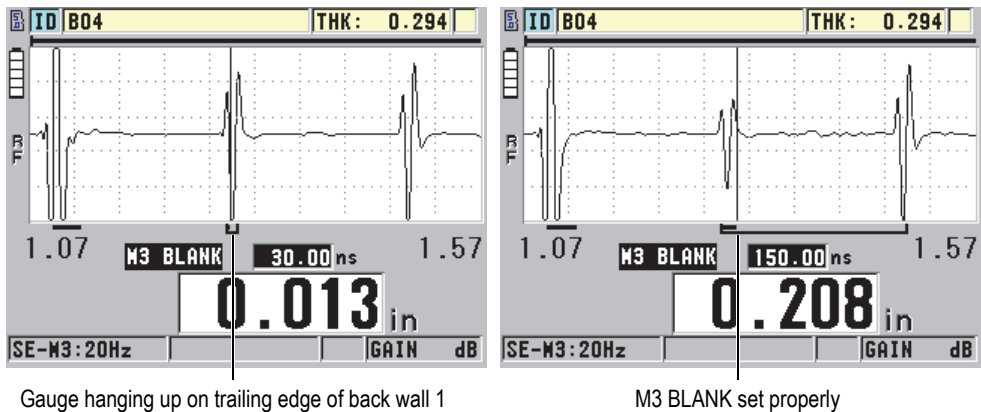

Figure 10-16 Examples of M3 Blank adjustment

Because the mode 3 echo blank limits minimum measurable thicknesses, set the controls to as short a period as possible; typically no longer than a few hundred nanoseconds. Special cases may be an exception where mode conversion effects on curved samples cause significant spurious signals between legitimate echo peaks. In such cases, set the mode 3 echo blank to as long a period as necessary in order to prevent detection of the spurious signals.

10.9 Saving Setup Parameters

After adjusting selected waveform parameters, it is possible to store the settings for quick and easy recall. The 45MG can store up to 35 custom setups in its internal memory.

To save setup parameters

1. Make the appropriate changes to the waveform parameters.
2. Press **[2nd F]**, **[FREEZE]** (**XDCR RECALL**).
In the menu, ensure that **ACTIVE** is highlighted. The changes you made are located in the active setup.
3. Press **[SAVE]**.
4. In the **SAVE SETUP** screen (see Figure 10-17 on page 192):
 - a) In the **SAVE AS** dialog box, enter a name for the custom setup.
 - b) In the **SAVE TO** list, select one of the 35 available custom setup locations.



CAUTION

Setups named **SE-USER-1** through **SE-USER-35** are empty locations. Use caution when selecting a location that already contains a custom setup, because the new setup will replace the old information.

-
- c) Select **SAVE** to save the custom setup.

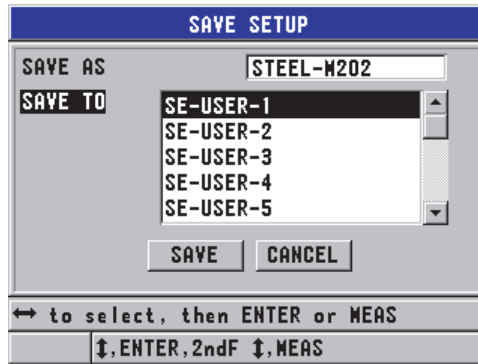

Figure 10-17 Saving custom setups

5. In the **ACTIVE** screen, review the setup parameters.
6. Press **[MEAS]** to return to the measurement screen.

10.10 Quickly Recalling a Custom Setup for Single Element Transducers

Normally, you can change the setup for a custom application by pressing **[RECALL XDCR]** to select the appropriate setup in the list of available setups), and then pressing **[MEAS]**. This process is adequate for typical setups that are changed infrequently. However, when it is necessary to change between two or more custom setups on a more frequent basis, use the quick setup recall function instead.

When the quick setup recall function is activated, a simple keypad shortcut can be used to quickly switch to any of the first four custom setups for single element transducers.

To activate the quick setup recall function

1. In the measurement screen, press **[SETUP]**, and then select **MEAS**.
2. In the **MEAS** screen, set **QUICK SETUP RECALL** to **ON**.
3. Press **[MEAS]** to return to the measurement screen.

To quickly recall one of the four first custom setups

- ◆ While in the measurement screen, with the quick setup recall function activated, press **[2nd F], [▲]** to recall the first custom single element transducer setup.
OR
Press **[2nd F], [▶]** to recall the second custom single element transducer setup.
OR
Press **[2nd F], [▼]** to recall the third custom single element transducer setup.
OR
Press **[2nd F], [◀]** to recall the fourth custom single element transducer setup.

NOTE

This feature only works when a single element transducer is plugged into the 45MG, and the single element transducer option has also been purchased.

11. Managing Communications and Data Transfer

This section describes the process through which the 45MG communicates with a computer to send, receive, import, and export files. The 45MG comes standard with a USB cable for communication using the USB 2.0 protocol.

11.1 GaugeView

GaugeView is the Evident interface program designed to communicate with instruments such as the 45MG. GaugeView provides the capability to create inspection database files, upload and download data files, and generate reports. Evident recommends using GaugeView to communicate with the 45MG, and to manage 45MG data.

GaugeView is compatible with Windows XP, Windows Vista, and Windows 7. For more details, refer to the *GageView Interface Program — User's Manual* (P/N: 910-259-EN [U8778347]).

11.2 Setting Up USB Communication

The communication protocol for the 45MG is USB 2.0.

To set up the USB communication

1. Ensure that the 45MG driver is installed on the computer.
This driver is installed when you install the GaugeView interface program.

NOTE

For more information on installing GaugeView, refer to the *GageView Interface Program – User’s Manual* (P/N: 910-259-EN [U8778347]).

2. If you use a communication program other than GaugeView, refer to the program documentation for proper configuration of the program for USB communication.
3. Turn the 45MG on.
4. Connect one end of a USB cable to the USB client connector on the top of the 45MG, and connect the other end to a USB port of the computer (see Figure 11-1 on page 196).

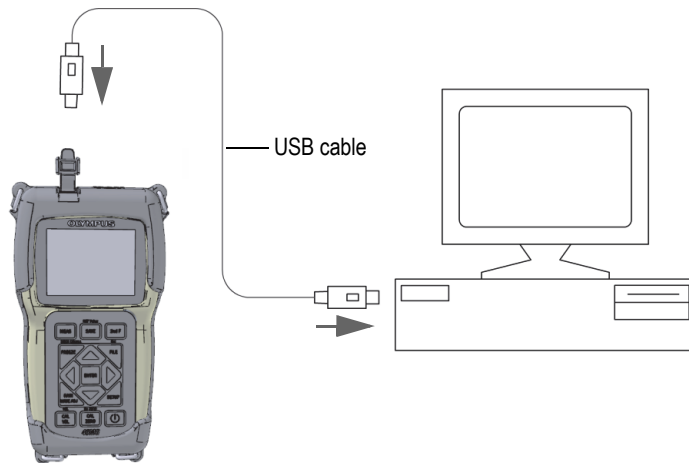

Figure 11-1 Connecting the 45MG to a computer

The first time the 45MG is connected to this computer, the computer alerts you that a new hardware device has been detected, and asks you if you want to install the driver. Refer to the *GageView Interface Program – User’s Manual* (P/N: 910-259-EN [U8778347]) for more information.

The driver loads, after which you can start using a program like GaugeView to communicate with the 45MG.

TIP

If you experience problems establishing communication between the 45MG and a remote device, consider using the 45MG communication reset function to return all communication parameters to their default values (see “Resetting the Communication Parameters” on page 203), and then reconfigure only those communication parameters that are needed.

11.3 Exchanging Data with a Remote Device

It is possible to exchange 45MG data with a remote device such as a computer.

NOTE

Data transmitted from the 45MG remains in the 45MG internal memory.

11.3.1 Exporting a File to the Memory Card (Datalogger Option Only)

The 45MG has the ability to export files from the internal memory to the external microSD memory card. Files can be exported in CSV (comma-separated variables), text (space delimited), or survey (used by the GaugeView interface program) format. A microSD card reader can then be used to open these files in Microsoft Excel, or any other program, directly on your computer. Survey files can be imported into GaugeView from the microSD card reader.

To export files to the external memory card

1. Ensure that a microSD memory card is inserted in the designated slot under the battery door of the 45MG (see Figure 1-4 on page 31).
2. If you inserted the microSD memory card when the 45MG was already turned on, turn off and restart the 45MG to force it to recognize the presence of the memory card.
3. In the measurement screen, press **[FILE]**, and then select **EXPORT**.
4. In the **EXPORT** screen (see Figure 11-2 on page 198):

- a) If necessary, select a different **SORT BY** parameter to change the way files are sorted in the file list.
 - b) In the file list, highlight the file you want to export.
 - c) Set **FILE** to the desired file format:
 - **SURVEY FILE**: For import into GaugeView.
 - **EXCEL CSV**: For data to be opened in CSV text format in Microsoft Excel.
 - **EXCEL GRID CSV**: For data to be opened in grid format in Microsoft Excel.
 - **TEXT FILE**: For data to be opened in various Windows-based programs.
5. Select **EXPORT**.
- The selected file is created in the following folder on the external microSD memory card: \EvidentNDT\45MG\Transfer.
- The instrument then automatically returns to the measurement screen.



Figure 11-2 The EXPORT screen

11.3.2 Importing Survey Files from the External Memory Card

It is possible to import a survey file from the external microSD memory card to the 45MG internal memory. This function can be used in conjunction with the GaugeView interface program to import survey files that have been exported from GaugeView to a microSD card. This feature allows you to import files into the 45MG while the instrument is in the field and cannot be connected to a computer.

To import survey files from the external memory card

1. Ensure that the \EvidentNDT\45MG\Transfer folder on your external microSD memory card contains the file you want to import into the 45MG's internal memory.
2. Insert the microSD memory card into its designated slot under the battery door of the 45MG (see Figure 1-4 on page 31).
3. If you inserted the microSD memory card while the 45MG was turned on, turn the 45MG off, and then back on so that it recognizes the presence of the memory card.
4. In the measurement screen, press **[FILE]**, and then select **IMPORT**.
5. In the **IMPORT** screen (see Figure 11-3 on page 199):
 - a) Select the file to be imported into the list of available files.
The listed files are those found in the \EvidentNDT\45MG\Transfer folder on the external microSD memory card.
 - b) Select **IMPORT**.
 - c) When a file with the same name already exists in the 45MG, the **Overwrite existing file?** message appears. When you still want to import the file, select **YES**.
A beep confirms the end of the file transfer and the instrument returns to the measurement screen.

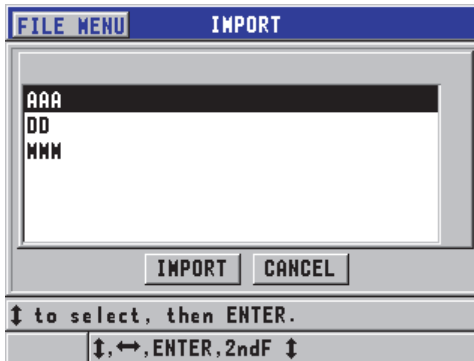

Figure 11-3 Example of the IMPORT screen

11.3.3 Receiving Files from a Computer

The same type of datalogger information that can be sent to a computer can also be received or downloaded from a computer to the instrument. There are two benefits:

- At the next survey date, months or years later, retrieve the previously saved survey thickness data stored in a computer file with ID numbers. This retrieved data can be used for the following purposes:
 - To guide you through the measurement sequence using the ID numbers.
 - To compare current values at the measurement site with previously measured thickness values.
 - To manually or automatically verify that the current measurement setup is identical to the previously used setup.
- Create ID number sequences in a computer, and then download them to the instrument. This externally created sequence can guide you through the prescribed measurement location path. The ID sequence created in the computer must have setup information. The setup can be the gauge default setups, or any other desired sequence of setups.

The data downloaded to the 45MG must be in the exact same format as the data transmitted. Evident recommends using the GaugeView interface program to handle all functions of interfacing, storing, and creating 45MG data. Please contact Evident for information on additional software data management programs.

To receive a data file from a computer

1. When using GaugeView or another program to send the file from the computer using the USB port (see “Setting Up USB Communication” on page 195), turn on the 45MG and make sure that the measurement screen is active.
2. From the computer, begin sending the formatted data.
The 45MG displays a **RECEIVING DATA** screen while the data is being sent, after which it returns to the measurement screen.

11.4 Capturing Screen Images

It is possible to save a screen capture of the full 45MG screen contents to an image file. This function is useful when you need an exact replica of the display for reporting or documentation purposes. A screen capture can be sent to GaugeView or the external microSD card.

11.4.1 Sending a Screen Capture to GaugeView

It is possible to send the full 45MG screen contents to the GaugeView interface program.

Refer to the *GageView Interface Program — User’s Manual* (P/N: 910-259-EN [U8778347]) for information on how to install and use GaugeView.

To send a screen capture to GaugeView

1. Set the USB communication parameters, and then connect the 45MG to the computer (see “Setting Up USB Communication” on page 195).
2. On the 45MG, select the screen that you want to capture.
3. On the computer, start up GaugeView.
4. In GaugeView, the following tasks are only to be performed the first time you connect the 45MG to GaugeView on this computer:
 - a) On the GaugeView menu, select **Device > Config**.
 - b) In the **Device Configuration** dialog box (see Figure 11-4 on page 201):
 - (1) In the **Device List**, select 45MG, and then click **Add**.
45MG (USB) appears in the **Current Configured Devices** list.
 - (2) Select the **Connect at Startup** check box to ensure that GaugeView automatically attempts to connect to the 45MG upon start-up.
 - (3) Click **OK**.

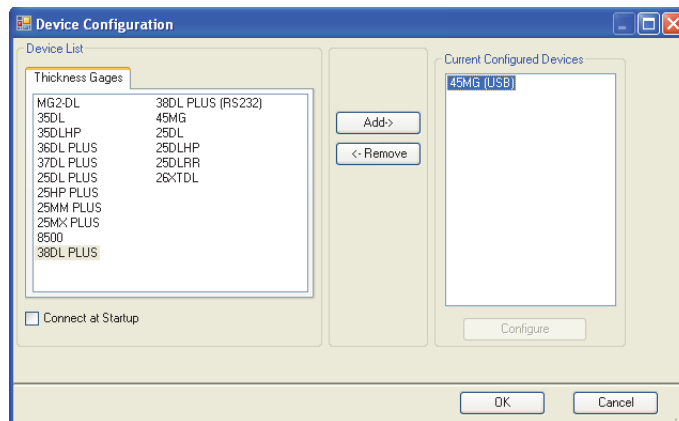

Figure 11-4 The Device Configuration dialog box

5. In GaugeView, perform the following tasks:
 - a) On the menu, select **Device > Tools**.
 - b) In the **Device Tools** dialog box (see Figure 11-5 on page 202), select **Screen Capture**, and then click **Receive**.
The screen image appears once the data transfer is complete.
 - c) Click **Copy** to copy the screen capture to the Windows clipboard.
OR
Click **Save** to save the image as a BMP file using the folder and file name of your choice.

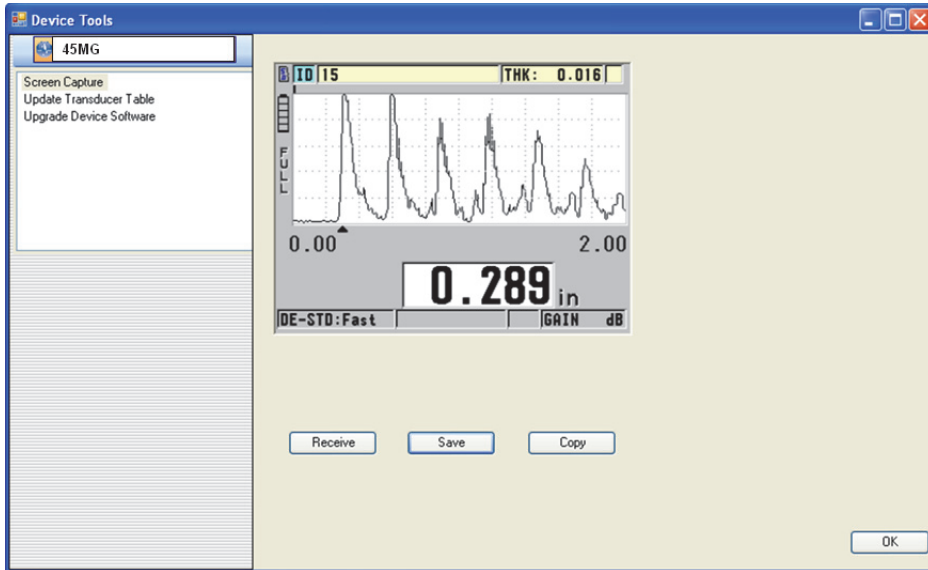

Figure 11-5 The Device Tools dialog box with a screen capture

11.4.2 Sending a Screen Capture to the External microSD Card

The 45MG has the capability to copy the contents of the current screen to the external microSD card. The resulting screenshot is saved as a bitmap (.bmp) file. You can then connect the microSD card to a computer and open the file in any program capable of viewing bitmap (.bmp) files.

To send a screen capture to the external microSD card

1. Ensure that a microSD memory card is inserted in its slot under the battery door of the 45MG (see Figure 1-4 on page 31).
2. If you inserted the microSD memory card while the 45MG was turned on, turn off and restart the 45MG to force it to recognize the presence of the memory card.
3. Ensure that the function for saving a screen capture to the microSD card is enabled:
 - a) In the measurement screen, press **[SETUP]**, and then select **SYSTEM**.
 - b) Set **PRINT SCREEN TO SD CARD** to **ON**.
4. Select the screen you want to capture.
5. Press **[2nd F]**, **[SETUP]**.
 The screen freezes for about 20 seconds as the file is being sent to the following folder on the external memory card: \EvidentNDT\45MG\Snapshot.
 The screenshots are automatically named BMP*n*.bmp, where *n* starts at 0 and is incremented by one each time a new screenshot is added.
6. To transfer the image file:
 - a) Remove the microSD memory card from its slot in the 45MG.
 - b) Using a microSD card reader, connect the memory card to a computer.
 - c) Copy the file from the \EvidentNDT\45MG\Snapshot folder on the card to the desired folder on the computer.

11.5 Resetting the Communication Parameters

The communication reset function quickly returns communication parameters to their factory default values. This function may be useful when you are experiencing difficulties in establishing communication with a remote device. Table 12 on page 203 summarizes the default values for the communication parameters.

Table 12 Default communication parameter values

Parameter	Value
COMM PROTOCOL	MULTI CHAR
OUTPUT FORMAT	F1
B-SCAN OUTPUT	OFF
FTP OUTPUT	45MG

Table 12 Default communication parameter values (continued)

Parameter	Value
OUTPUT TYPE	FTP

To reset the communication parameters

1. Press **[SETUP]**, and then select **RESETS**.
2. In the **RESETS** screen (see Figure 11-6 on page 204):
 - a) In the **RESETS** list, select **COMMUNICATION RESET**.
 - b) Select **RESET**.

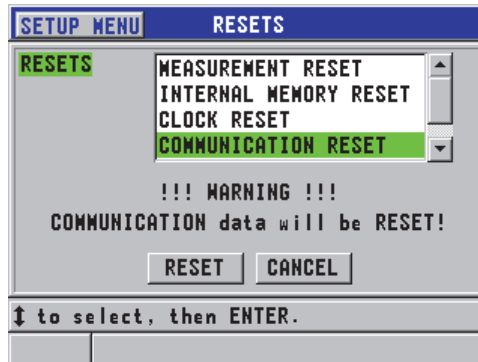
**Figure 11-6 Selecting COMMUNICATION RESET**

12. Maintaining and Troubleshooting the 45MG

To properly maintain and troubleshoot the 45MG, this chapter provides instructions on proper handling, reset functions, software diagnostics, error messages, and problem resolution.

12.1 Routine Gauge Handling

The 45MG case is sealed to prevent ingress of environmental liquids and dust when the battery door is closed. However, the instrument should never be immersed in any fluid.

The 45MG case is designed to withstand normal field use. However, as with any electronic instrument, damage is possible if the instrument is not handled with adequate care. Observe the following instructions in particular:

- Never press a key using a hard or sharp object.
- When connecting cables to the instrument, first align the connector with the mating receptacle on the instrument (dual element D79X series transducer center pin protruding downward), and then carefully insert the connector straight into the receptacle.
- When disconnecting cables from the instrument, first grasp the connector (not the cable), and then gently pull it out.
- Do not throw or drop the instrument.
- Do not use strong solvents or abrasives to clean the rubber boot, case, keypad, or display screen.

12.2 Cleaning the Instrument

First, clean the instrument with a dry damp cloth. If necessary, use a wet damp cloth with a mild detergent to wash the instrument. Dry the instrument before using it.

12.3 Maintaining Transducers

The ultrasonic transducers used with the 45MG are rugged devices that need little care. However, they are not indestructible, and some attention to the following items result in a longer lifespan.

- Take high-temperature measurements only with suitable high-temperature transducers. Standard transducers can be damaged or destroyed if brought into contact with surfaces hotter than approximately 125 °F (52 °C).
- Cutting, pinching, or pulling the cables causes damage to them. Take care to prevent mechanical abuse to the cables. Never leave a transducer in any area where there is a risk that a heavy object could be placed on the cable. Never remove a transducer from the gauge by pulling on the cable; pull on the molded connector only. Never tie a knot in the transducer cable. Do not twist or pull the cable at the point where it connects to the transducer.
- Excessive wear at the tip of the transducer degrades its performance. To minimize wear, do not scrape or drag the transducer across rough surfaces. Operation of the transducer may become erratic or impossible in the event that a transducer tip becomes rough or cracked. Although some wear is normal, severe wear limits transducer life. Take particular care with plastic delay line transducers; replace worn delay lines.

12.4 Using Instrument Resets

The 45MG includes reset functions that can be used to quickly restore the gauge to its default parameters. Resets are useful shortcuts to known configurations. The reset functions are as follows:

MEASUREMENT RESET

Changes the measurement parameters to the default factory values listed in Table 13 on page 207.

Table 13 Measurement default settings

Parameter	Default value
Measurement mode with differential	Fast, min, max, and alarms turned off
Material sound velocity	5.969 mm/s (or 0.2350 in./s) (approximate velocity of the included test blocks)
Differential reference value	0.0 mm (or 0.0 in.)
Low alarm reference value	0.0 mm (or 0.0 in.)
High alarm reference value	635.0 mm (or 25.0 in.)
Display update rate	4 per second
Zoom	Off
Range	Minimum range
LOS condition	Blank thickness display
Resolution	0.01 mm (or 0.001 in.)

INTERNAL MEMORY RESET

Deletes all stored data on the internal microSD memory card and reformats the card.

**CAUTION**

The internal memory reset permanently deletes all thickness readings/waveforms that are stored in the memory card. However, this reset does not delete any stored transducer setups.

CLOCK RESET

Resets the date to 01/01/2010 in the MM/DD/YYYY format, and the time to 12:00 A.M. in the 12-hour format.

COMMUNICATION RESET

Changes the communication settings to the default factory values listed in Table 14 on page 208.

Table 14 Default communication settings

Parameter	Default value
COMM PROTOCOL	MULTI CHAR
OUTPUT FORMAT	F1
B-SCAN OUTPUT	OFF
FTP OUTPUT	45MG
OUTPUT TYPE	FTP

MASTER RESET

Performs the measurement reset and the internal memory reset in a single step.

**CAUTION**

The master reset permanently deletes all stored thickness readings/waveforms that are stored in the internal memory card of the 45MG.

To activate a reset function

1. In the measurement screen, press **[SETUP]**, and then select **RESETS**.
2. In the **RESETS** screen (see Figure 12-1 on page 209):
 - a) In the **RESETS** list, highlight the desired reset function.
A warning message appears, indicating the type of data that will be reset.
 - b) Select **RESET**.

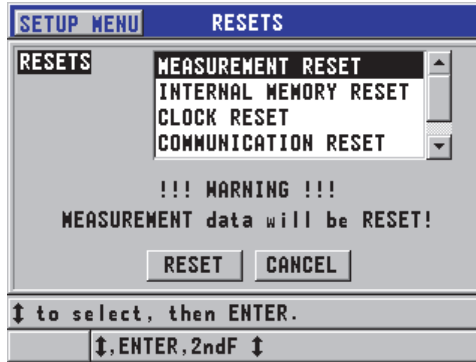

Figure 12-1 Activating a reset function

12.5 Performing Hardware Diagnostic Tests

The 45MG includes a function that can be used to perform several diagnostic self tests. The tests can help to localize a suspected hardware problem, or to verify correct hardware operation. Some tests are designed for Evident internal testing procedures during the manufacturing process.

The available tests are as follows:

- Keypad test
- Video test
- Internal microSD card test (Pass or Fail)
- External microSD card test (Pass or Fail)
- Dual element transducer test
- ESS test (Electronic Stress Screening) [for Evident internal use only]
- B-scan test (for Evident internal use only)
- Battery test (for Evident internal use only)
- One-wire test (for Evident internal use only)

To perform a diagnostic test

1. In the measurement screen, press [SETUP], and then press **SP MENU**.
2. In the **SP MENU** (see Figure 4-2 on page 55), select **TESTS**.

3. In the **TESTS** screen, select the desired test, and then press **[ENTER]**.
4. When **KEYPAD TEST** is selected, in the **KEYPAD TEST** screen (see Figure 12-2 on page 210), perform the following steps:
 - a) Test any key by pressing it on the keypad.
When that specific key is working correctly, the instrument displays the name of the key in the **Last Key pressed** box.
 - b) Press **[ENTER]** to terminate the keypad test.

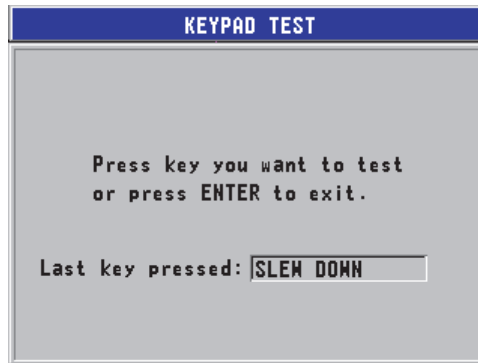

Figure 12-2 The KEYPAD TEST screen

5. When **VIDEO TEST** is selected:
 - a) In the **VIDEO TEST** screen, press **[MEAS]** to start the video test.
The display shows vertical color strips. Any problems with the display show up as a disruption of the pattern.
 - b) Press **[ENTER]** to terminate the video test.
6. When **INTERNAL SD CARD TEST** or **EXTERNAL SD CARD TEST** is selected, in the **INTERNAL SD CARD TEST** or **EXTERNAL SD CARD TEST** screen:
 - a) Press **[MEAS]** to start the test.
The test result appears under **SD Card Test Status**. The possible results are as follows:
 - **PASS**: Indicates that the card is functioning properly.
 - **FAIL**: Indicates that there is a problem with the memory card. When the external card fails, reinstall or replace the card, and then restart the instrument. When the internal card fails, contact Evident for service.
 - b) Press **[ENTER]** to terminate the **SD CARD** test.

7. When **DUAL XDCR TEST** is selected, in the **DUAL XDCR TEST** screen (see Figure 12-3 on page 211):
 - a) Press **[MEAS]** to start the test that measures the time of flight through each side of a dual element transducer.
The measured parameter values appear.
 - b) Interpret the **Tx** and the **Rx** values as follows:
 - Similar values indicate a normal dual element transducer.
 - A difference between the values indicates that the delay line wear is not the same for each element.
 - A missing value indicates that a cable is broken, or that the element is not functioning.
 - c) Take note of the calculated **ZERO VALUE**.
 - d) Press **[ENTER]** to terminate the dual element transducer test.

DUAL XDCR TEST	
Press MEAS key to start test or press ENTER to exit.	
TYPE	0790/791
Tx:	2764
Rx:	2766
ZERO VALUE	620.00

Figure 12-3 The DUAL XDCR TEST screen

12.6 Performing the Software Diagnostic Test

The software diagnostic (**SW DIAG**) function generates an error log documenting all errors that occurred during instrument operation. Evident uses this information to troubleshoot the 45MG operating software.

To access the software diagnostic

1. In the measurement screen, press **[SETUP]**, and then select **SP MENU**.

2. In the **SP MENU** (see Figure 4-2 on page 55), select **SW DIAG**.
The **SW DIAG** screen appears, which contains the error log (see Figure 12-4 on page 212).

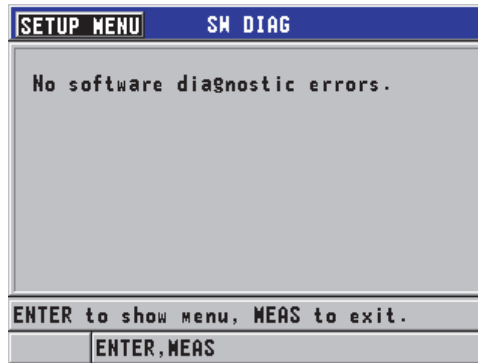

Figure 12-4 Example of the SW DIAG screen

3. Press **[MEAS]** to return to the measurement screen.

12.7 Viewing the Instrument Status

The **STATUS** screen lists important information about the instrument. The status screen displays the following information:

- Current instrument internal temperature
- Current battery charge level
- Instrument model
- Software release date (build date)
- Software version
- Hardware version
- Options code (S/N) to be communicated to Evident for software option activation

To view the instrument status

1. In the measurement screen, press **[SETUP]**, then select **SP MENU**.

- In the **SP MENU** (see Figure 4-2 on page 55), select **STATUS** (see Figure 12-5 on page 213).

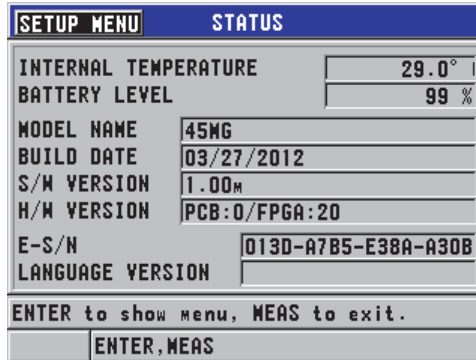

Figure 12-5 Example of the STATUS screen

- Press **[MEAS]** to return to the measurement screen.

12.8 Understanding Error Messages

When operating the gauge, certain error messages may appear. These messages usually indicate a problem with the operating procedure, but certain messages might indicate a physical problem with the gauge itself. If you do not understand an error message, contact Evident for assistance.

12.9 Resolving Battery Problems

The power indicator (in the upper-left corner of the display) contains bars that indicate the percentage of remaining battery charge level. When the charge level becomes low, the gauge automatically turns off. If the gauge turns off immediately after you turn it on, or if you are unable to turn it on, the batteries are probably depleted.

Replace the batteries with three new AA-size batteries.

12.10 Resolving Measurement Problems

Table 15 Measurement troubleshooting

Symptom	Possible explanation
No echoes or weak echoes, and no measurement (LOS)	<ul style="list-style-type: none"> • There is insufficient couplant, especially on rough or curved surfaces. • The gain is set too low. • The material is too attenuating, or the surfaces are unparallelled or too rough. • The gauge requires service; try the master reset. • The echo is too low in amplitude to be detected. Try increasing the gain.
Strong echoes, no measurements	<ul style="list-style-type: none"> • The echo may be in a blank area of the waveform, and cannot be detected. • The echo is outside of the echo window.
Strong echoes, incorrect measurements	<ul style="list-style-type: none"> • Out of calibration; perform calibration. • Differential mode — check DIFF flag. • Min or Max mode — see “Using the Minimum, Maximum, or Min/Max Thickness Mode” on page 139. • The material is too grainy, has flaws, inclusions or laminations, or very high surface noise; try manual gain adjustment or extended blank.

Appendix A: Technical Specifications

Table 16 General EN15317 specifications

Parameter	Value
Size	Height × Width × Depth (without protective boot): 162.0 mm × 91.1 mm × 41.1 mm (6.38 in. × 3.59 in. × 1.62 in.)
Weight	430.9 g (0.95 lb)
Power supply types	Three AA-size batteries: Alkaline (nonrechargeable), NiMH (externally rechargeable), or lithium (nonrechargeable)
Probe socket types	Dual LEMO with center pin IP67
Battery operating time	For continuous measurement at an update rate of 4 Hz with the backlight set to 20 %: Alkaline (nonrechargeable) 20–21 hours NiMH (externally rechargeable) 22–23 hours Lithium (nonrechargeable) 35–36 hours
Operating temperature	–10 °C to 50 °C (14 °F to 122 °F)
Battery storage temperature	–20 °C to 40 °C (–4 °F to 104 °F)
Battery indicator	Five-step battery charge level indication
Pulse repetition frequency (PRF)	1 kHz burst Measurement rates: 4 Hz, 8 Hz, 16 Hz, and Fast or Max (up to 20 Hz)
Alarm indicators	Visual high-alarm and low-alarm indicators with audio tone
Thru coating	Echo-to-echo and THRU-COAT measurements
Minimum and maximum thickness	Single element: 0.1 mm to 635.0 mm (0.004 in. to 25.0 in.) Dual element: 0.5 mm to 635.0 mm (0.020 in. to 25 in.) Note: The exact thickness range depends on the transducer type and measurement mode used.

Table 17 Display EN15317 specifications

Parameter	Value
Type	Color graphical TFT, LCD, 320 × 240 pixels
Size	[Height] × [Width], [Diagonal] 41.15 mm × 54.61 mm, 68.58 mm (1.62 in. × 2.15 in., 2.70 in.)

Table 18 Transmitter EN15317 specifications

Parameter	Value
Transmitter pulse	Adjustable square wave pulser
Pulser voltage	Pulse voltages: 60 V, 110 V, 150 V, and 200 V
Pulse rise time	Damping in: 5 ns typical Damping out: 3.5 ns typical (pulse-width dependent)
Pulse duration	Adjustable to probe frequency

Table 19 Receiver EN15317 specifications

Parameter	Value
Gain control	Automatic or manual: 40 dB to 99 dB
Frequency range	0.5 MHz to 24 MHz typical (filter dependent)

Table 20 Other EN15317 specifications

Parameter	Value
Data storage	Internal and external microSD memory cards, maximum capacity of 2 GB. Each card: 475000 thickness readings or 20000 waveforms with thickness readings
Data output types	2.0 USB client Removable microSD memory card
Calibration setting storage	Default single and dual element transducer setups 35 custom setups (single element)

Table 20 Other EN15317 specifications (continued)

Parameter	Value
Calibration	Single or two-point calibration using a test block Velocity can be entered manually.
Display response time	Normal (4 Hz) or fast (up to 20 Hz) for dual element transducers Adjustable: 4 Hz, 8 Hz, 16 Hz, and Max (up to 20 Hz) for single element transducers
Number of pixels to display a waveform	320 × 240 pixels

Table 21 Environmental rating specifications

Parameter	Value
IP rating	Designed for IP67
Explosive atmosphere	MIL-STD-810G, Section 511.5, Procedure I
Shock test	MIL-STD-810G, Section 516.6, Procedure I
Vibration test	MIL-STD-810G, Section 514.6, Procedure I
Drop test	MIL-STD-810G, Section 516.6, Procedure IV- Transit Drop

Table 22 Measurement specifications

Parameter	Value
Measurement modes	<p>Standard dual element: Time between excitation pulse and first back-wall echo using dual element transducer.</p> <p>Dual Echo-to-Echo: Time between successive back-wall echoes using dual element transducers.</p> <p>THRU-COAT: Time between excitation pulse and first back-wall echo while ignoring or displaying a coating thickness.</p> <p>Mode 1: Time between excitation pulse and first echo following a blank period using contact transducers.</p> <p>Mode 2: Time between the interface echo and the first back-wall echo. Normally used with delay line or immersion transducers.</p> <p>Mode 3: Time between a pair of back-wall echoes following the interface echo. Normally used with delay line or immersion transducers.</p>
V-path correction	Automatic, dependent on transducer type

Table 22 Measurement specifications (continued)

Parameter	Value
Measurement resolution	Selectable from the keypad: LOW: 0.1 mm (0.01 in.) STD: 0.01 mm (0.001 in.) HI: 0.001 mm (0.0001 in.) with the High Resolution option. Not all resolutions are available for all measurement modes.
Material sound velocity range	0.508 mm/ μ s to 18.699 mm/ μ s (0.0200 in./ μ s to 0.7362 in./ μ s)
Material sound velocity resolution	0.001 mm/ μ s (0.0001 in./ μ s)
Alarm set point range	0.00 mm to 500.00 mm (0.00 in. to 20.00 in.)

Table 23 Datalogger specifications

Parameter	Value
Storage capacity	475000 thickness readings or 20000 waveforms with thickness readings
ID number length	1 to 20 characters
File name length	1 to 32 characters
File formats	Incremental Sequential (defined by starting and ending ID number) Sequential with custom points 2-D grid Boiler
External memory card	microSD memory card 2 GB maximum capacity

Table 24 Transducer selection

Probe	MHz	Connector	Tip diameter	Range (steel)	Temperature range
D7910	5.0	Right angle	12.7 mm (0.50 in.)	1 mm to 254 mm (0.040 in. to 10 in.)	0 °C to 50 °C (32 °F to 122 °F)
D790 D790-SM D790-RL D790-SL	5.0	Straight Straight Right angle Straight	11.0 mm (0.434 in.)	1 mm to 500 mm (0.040 in. to 20 in.)	-20 °C to 500 °C (-5 °F to 932 °F)
D791	5.0	Right angle	11.0 mm (0.434 in.)	1 mm to 500 mm (0.040 in. to 20 in.)	-20 °C to 500 °C (-5 °F to 932 °F)
D791-RM	5.0	Right angle	11.0 mm (0.434 in.)	1 mm to 500 mm (0.040 in. to 20 in.)	-20 °C to 400 °C (-5 °F to 752 °F)
D792 D793	10	Straight Right angle	7.2 mm (0.283 in.)	0.5 mm to 25 mm (0.020 in. to 1 in.)	0 °C to 50 °C (32 °F to 122 °F)
D7912	10.0	Straight	7.5 mm (0.295)	0.5 mm to 25 mm (0.020 in. to 1 in.)	0 °C to 50 °C (32 °F to 122 °F)
D7913	10.0	90 degree	7.5 mm (0.295)	0.5 mm to 25 mm (0.020 in. to 1 in.)	0 °C to 50 °C (32 °F to 122 °F)
D794	5.0	Straight	7.2 mm (0.283 in.)	0.75 mm to 50 mm (0.030 in. to 2 in.)	0 °C to 50 °C (32 °F to 122 °F)

Table 24 Transducer selection (continued)

Probe	MHz	Connector	Tip diameter	Range (steel)	Temperature range
D797 D797-SM	2.0	Right angle Straight	22.9 mm (0.900 in.)	3.8 mm to 635 mm (0.150 in. to 25 in.)	-20 °C to 400 °C (-5 °F to 752 °F)
D7226 D798-LF	7.5	Right angle	8.9 mm (0.350 in.)	0.71 mm to 50 mm (0.028 in. to 2 in.)	-20 °C to 150 °C (-5 °F to 300 °F)
D798 D798-SM	7.5	Right angle Straight	7.2 mm (0.283 in.)	0.71 mm to 50 mm (0.028 in. to 2 in.)	-20 °C to 150 °C (-5 °F to 300 °F)
D799	5.0	Right angle	11.0 mm (0.434 in.)	1 mm to 500 mm (0.040 in. to 20 in.)	-20 °C to 150 °C (-5 °F to 300 °F)
MTD705	5.0	Right angle	5.1 mm (0.200 in.)	1.0 mm to 19 mm (0.040 in. to 0.75 in.)	0 °C to 50 °C (32 °F to 122 °F)

Table 25 Typical ranges and default setups for single element transducers^a

Setup name	Transducer	Typical measurement range
DEFM1-20.0-M116	M116	Steel: 0.508 mm to 38.10 mm (0.020 in. to 1.500 in.)
DEFM1-10.0-M112	M112	Steel: 0.760 mm to 250.00 mm (0.030 in. to 10.000 in.)
DEFM1-10.0-M1016	M1016	Steel: 0.760 mm to 250.00 mm (0.030 in. to 10.000 in.)
DEFM1-5.0-M110	M110	Steel: 1.00 mm to 380.00 mm (0.040 in. to 15.000 in.)
DEFM1-5.0-M109	M109	Steel: 1.00 mm to 500.00 mm (0.050 in. to 20.000 in.)
DEFM1-2.25-M106	M106	Steel: 2.00 mm to 635.00 mm (0.080 in. to 25.000 in.)
DEFM1-2.25-M1036	M1036	Steel: 2.00 mm to 635.00 mm (0.080 in. to 25.000 in.)

Table 25 Typical ranges and default setups for single element transducers^a

Setup name	Transducer	Typical measurement range
DEFM3-20.0-M208	M208	Steel: 0.25 mm to 5.00 mm (0.008 in. to 0.200 in.)
DEFP2-20.0-M208	M208	Plastic: 0.12 mm to 5.00 mm (0.005 in. to 0.200 in.)
DEFM3-10.0-M202	M202	Steel: 0.25 mm to 12.00 mm (0.010 in. to 0.500 in.)
DEFM2-10.0-M202	M202	Steel: 0.75 mm to 12.00 mm (0.030 in. to 0.500 in.)
DEFP2-10.0-M202	M202	Plastic: 0.60 mm to 6.00 mm (0.025 in. to 0.250 in.)
DEFM3-15.0-V260	V260	Steel: 0.25 mm to 5.00 mm (0.010 in. to 0.200 in.)
DEFM2-15.0-V260	V260	Steel: 0.75 mm to 12.50 mm (0.030 in. to 0.500 in.)
DEFP2-15.0-V260	V260	Plastic: 0.25 mm to 3.00 mm (0.010 in. to 0.120 in.)
DEFM2-5.0-M201	M201	Steel: 1.50 mm to 25.40 mm (0.050 in. to 1.000 in.)
DEFP2-5.0-M201	M201	Plastic: 0.62 mm to 12.50 mm (0.025 in. to 0.500 in.)
DEFM2-5.0-M206	M206	Steel: 1.25 mm to 19.00 mm (0.050 in. to 0.750 in.)
DEFP2-5.0-M206	M206	Plastic: 1.00 mm to 12.50 mm (0.040 in. to 0.500 in.)
DEFM2-2.25-M207	M207	Steel: 2.00 mm to 19.00 mm (0.080 in. to 0.750 in.)
DEFP2-2.25-M207	M207	Plastic: 2.00 mm to 12.50 mm (0.080 in. to 0.500 in.)
DEFM1-0.5-M101	M101	Steel: 12.50 mm to 635.00 mm (0.500 in. to 25.000 in.)
DEFM1-1.0-M102	M102	Steel: 5.00 mm to 635.00 mm (0.200 in. to 25.000 in.)
DEFM1-1.0-M103	M103	Steel: 2.50 mm to 635.00 mm (0.100 in. to 25.000 in.)
DEFP1-0.5-M2008	M2008	Fiberglass: 5.00 mm to 76.00 mm (0.200 in. to 3.000 in.)

- a. The maximum thickness measuring capability depends on the transducer type, material conditions, and temperature.

Table 26 Setup parameter description

Name	Description	Units/Resolutions/Range
MEAS OPTION	Echo detect mode	Standard dual Dual Echo-to-Echo THRU-COAT Mode 1 Mode 2 Mode 3
MEAS TYPE	Special measurement modes	Standard First Peak (with Single Element option)

Table 26 Setup parameter description (continued)

Name	Description	Units/Resolutions/Range
PROBE TYPE	Transducer types	Dual element Direct contact (with Single element option) Delay line Immersion
PULSER POWER	Pulser power	60 V, 110 V, 150 V, or 200 V
MAX GAIN	Maximum receiver gain	0.0 dB to 99.0 dB, 0.3 dB steps
INIT GAIN	Initial TDG gain	0 to Max Gain, 1 dB steps.
TDG SLOPE	Time Gain slope (default)	0.0 dB/s to 39.9 dB/s
MB BLANK	Main bang blank	0 ns to 225 μ s
ECHO WINDOW	Echo detect gate which begins at end of MB (main bang) blank in mode 1, or interface echo in modes 2 and 3. The value reported for the end of the echo window is relative to the main bang.	0 ns to 224.71 μ s, 55 ns, or MB blank time interval, whichever is less.
ECHO 1 DETECT	Detection polarity of first echo	+ or -
ECHO 2 DETECT	Detection polarity of second echo	+ or -
IF BLANK	Blank after interface echo	0 μ s to 20 μ s
M3 BLANK	Blank after first measured back-wall echo in mode 3	0 μ s to 20 μ s
VELOCITY	Ultrasonic sound velocity of material to be measured	0.508 mm/ μ s to 18.699 mm/ μ s (0.0200 in./ μ s to 0.7362 in./ μ s)
ZERO	Zero calibration factor	0.00 to 999.99

Table 27 General specifications

Element	Description
Keypad	Sealed and embossed membrane surface. Tactile and audible feedback, color-coded graphics, 15 keys.
Dual element transducers	Automatically identifies the transducer type and optimizes the gauge for that transducer. Non-Evident transducers might work, but performance is not guaranteed. The following transducers are supported: D790, D790-SM, D791, D791-RM, D792, D7912, D793, D7913, D794, D797, D798, D7906-SM, D7908, D799, and MTD705.
Single element transducers (optional)	Can be used with contact, delay line, and immersion transducers from 2.25 MHz to 30 MHz. High Penetration software option expands the frequency range from 0.5 MHz to 30.0 MHz

Appendix B: Sound Velocities

The following table lists the sound velocities in a variety of common materials. Use this table only as a guide. The actual velocity in these materials may vary significantly due to a variety of causes, such as composition, preferred crystallographic orientation, porosity, and temperature. Therefore, for maximum accuracy when establishing the sound velocity in a given material, first test a sample of the material.

Table 28 Sound velocities in common materials

Material	V (m/s)	V (in./ μ s)
Acrylic resin (Perspex)	2730	0.107
Aluminum	6320	0.249
Beryllium	12900	0.508
Brass, naval	4430	0.174
Copper	4660	0.183
Diamond	18000	0.709
Glycerin	1920	0.076
Inconel	5820	0.229
Iron, Cast (slow)	3500	0.138
Iron, Cast (fast)	5600	0.220
Iron oxide (magnetite)	5890	0.232
Lead	2160	0.085
Lucite	2680	0.106
Molybdenum	6250	0.246
Motor oil (SAE 20/30)	1740	0.069
Nickel, pure	5630	0.222

Table 28 Sound velocities in common materials (continued)

Material	V (m/s)	V (in./ μ s)
Polyamide (slow)	2200	0.087
Nylon, fast	2600	0.102
Polyethylene, high-density (HDPE)	2460	0.097
Polyethylene, low-density (LDPE)	2080	0.082
Polystyrene	2340	0.092
Polyvinyl chloride, (PVC, hard)	2395	0.094
Rubber (polybutadiene)	1610	0.063
Silicon	9620	0.379
Silicone	1485	0.058
Steel, 1020	5890	0.232
Steel, 4340	5850	0.230
Steel, 302 austenitic stainless	5660	0.223
Steel, 347 austenitic stainless	5740	0.226
Tin	3320	0.131
Titanium, Ti 150A	6100	0.240
Tungsten	5180	0.204
Water (20 °C)	1480	0.0580
Zinc	4170	0.164
Zirconium	4650	0.183

References

Folds, D. L. *Experimental Determination of Ultrasonic Wave Velocities in Plastics, Elastomers, and Syntactic Foam as a Function of Temperature*. Panama City, Florida: Naval Research and Development Laboratory, 1971.

Fredericks, J. R. *Ultrasonic Engineering*. New York: John Wiley & Sons, Inc., 1965.

Handbook of Chemistry and Physics. Cleveland, Ohio: Chemical Rubber Co., 1963.

Mason, W. P. *Physical Acoustics and the Properties of Solids*. New York: D. Van Nostrand Co., 1958.

Papadakis, E. P. Panametrics – unpublished notes, 1972.

Appendix C: Accessories and Replacement Parts

Table 29 Software options

Description	Part number
Optional Echo-to-Echo & THRU-COAT (installed in units using an activation code)	45MG-EETC [U8147021]
Optional Datalogger software (installed in units using an activation code)	45MG-DL [U8147020]
Optional Waveform software (installed in units using an activation code)	45MG-WF [U8147019]
Optional Single Element including High Resolution (installed in units using an activation code)	45MG-SE [U8147022]
Optional Single Element & High Penetration software (installed in units using an activation code)	45MG-HP [U8147023]

Table 30 Accessories and replacement parts

Description	Part number
Carrying case	45MG-CC [U8764105]
Protective rubber boot	45MG-RPC [U8779676]
Gauge stand	45MG-GS [U8780044]
Chest harness	441-087 [U8902895]
Rectangular rubber boot rings	412-1061LF [U8907259]
45MG documentation CD	45MG-MAN-CD [U8147024]
45MG Getting Started Guide	DMTA-10024-01EN [U8778520]
Interface program CD-ROM (standard)	GaugeView [U8147006]

Table 30 Accessories and replacement parts (continued)

Description	Part number
Batteries	Alkaline, NiMH, or lithium

Table 31 Interface cables and power accessories

Description	Part number
1.83 m (6 ft) USB cable (connection on top of instrument)	EPLTC-C-USB-A-6 [U8840031]
2 GB external microSD memory card	MICROSD-ADP-2GB [U8779307]

Table 32 Couplants

Description	Part number
Glycerin, 0.06 l (2 oz.)	Couplant B-2 [U8770023]
Gel type, 0.35 l (12 oz.)	Couplant D-12 [U8770026]
High temperature couplant up to 398 °C (750 °F), 0.06 l (2 oz.)	Couplant H-2 [Q7700002]

Table 33 Test blocks

Description	Part number
5-step, 1018 steel English units: 0.100 in., 0.200 in., 0.300 in., 0.400 in., 0.500 in.	2214E [U8880014]
5-step, 1018 steel Metric units: 2.5 mm, 5.0 mm, 7.5 mm, 10.0 mm, 12.5 mm	2214M [U8880016]
5-step, aluminum English units: 0.100 in., 0.200 in., 0.300 in., 0.400 in., 0.500 in.	2213E [U8880010]
4-step, 1018 steel English units: 0.250 in., 0.500 in., 0.750 in., 1.500 in.	2212E [U8880008]
2-step, 303 stainless steel English units: 0.050 in., 0.150 in.	2218E [U8880022]
2-step, 303 stainless steel Metric units: 1 mm, 15 mm	2218M [U8880024]

Table 33 Test blocks (continued)

Description	Part number
2-step, 303 stainless steel, English units: 0.200 in., 1.500 in.	2219E [U8880026]
2-step, 303 stainless steel, Metric units: 5 mm, 30 mm	2219M [U8880028]

List of Figures

Figure i-1	The 45MG instrument	25
Figure 1-1	The 45MG hardware components – Front, top, and side views	30
Figure 1-2	The 45MG connections	30
Figure 1-3	The top end connectors	31
Figure 1-4	The microSD connector behind the battery door	31
Figure 1-5	The 45MG keypads	32
Figure 2-1	The power indicator when using batteries	37
Figure 2-2	The power indicator when using a computer or an AC power supply	38
Figure 2-3	Opening the battery compartment	39
Figure 2-4	Selecting the battery type	41
Figure 3-1	The measurement screen – No waveform enabled	43
Figure 3-2	The measurement screen – Waveform option enabled	44
Figure 3-3	The ID bar	44
Figure 3-4	Other elements – No Waveform option enabled	45
Figure 3-5	Other elements – Waveform option enabled	46
Figure 3-6	The loss-of-signal (LOS) indicator	46
Figure 3-7	Menu and submenu example	47
Figure 3-8	Parameter screen example	48
Figure 3-9	Example of the virtual keyboard	50
Figure 3-10	The character cycle of the traditional text edit method	51
Figure 4-1	The SYSTEM screen	54
Figure 4-2	The SP MENU screen	55
Figure 4-3	The CLOCK screen	55
Figure 4-4	The DISPLAY screen	56
Figure 4-5	Example of the indoor and the outdoor color schemes	57
Figure 4-6	The measurement update rate indicator	59
Figure 5-1	Plugging in the transducer	62
Figure 5-2	Initial screen with a standard D79X dual element transducer	62
Figure 5-3	Selecting a default single element transducer setup	63
Figure 5-4	Sound velocity calibration on a five-step test block – Thick part	65

Figure 5-5	Performing the sound velocity calibration on a five-step test block	66
Figure 5-6	Sound velocity calibration on a five-step test block – Thin part	66
Figure 5-7	Performing the zero calibration on a five-step test block	67
Figure 5-8	Example of a five-step test block	68
Figure 5-9	Entering a known material sound velocity	70
Figure 5-10	The calibration lock message	71
Figure 5-11	Coupling a dual element transducer	74
Figure 5-12	Reading the measured thickness	75
Figure 5-13	The active file name appearing in the ID bar	75
Figure 6-1	The OPTIONS screen	79
Figure 6-2	Measuring with the standard echo detection mode	80
Figure 6-3	Measuring with the automatic Echo-to-Echo detection mode	81
Figure 6-4	Measuring with the manual Echo-to-Echo detection mode	82
Figure 6-5	Comparing manual measurements	84
Figure 6-6	Opening the THRU-COAT setup dialog box	87
Figure 6-7	Standard display	89
Figure 6-8	Waveform display	90
Figure 6-9	Examples of the rectification modes	91
Figure 6-10	Examples of waveform trace modes	92
Figure 6-11	The range of the waveform display	93
Figure 6-12	Comparing the normal and zoomed display in mode 1	95
Figure 6-13	Comparing the normal and zoomed display in mode 2	95
Figure 6-14	Comparing the normal and zoomed display in mode 3	96
Figure 6-15	The active file name appears in the ID bar	99
Figure 6-16	Identifying datalogger parameters	100
Figure 6-17	Example of the CREATE screen	103
Figure 6-18	The CREATE screen for the incremental data file type	105
Figure 6-19	Selecting the ID range for the sequential file type	107
Figure 6-20	Defining an ID range for a sequential data file with custom points	108
Figure 6-21	General 2-D grid example	109
Figure 6-22	One grid for 75 identical parts	110
Figure 6-23	Differently named grid for each part	111
Figure 6-24	Configuring the ID range for a 2-D grid data file type	112
Figure 6-25	Configuring the ID range for a boiler data file type	114
Figure 6-26	The FILE menu	116
Figure 6-27	Opening a file	117
Figure 6-28	Copying a file	118
Figure 6-29	Entering new file information	120
Figure 6-30	Displaying the grid edit screen	121
Figure 6-31	Deleting a file	122
Figure 6-32	Deleting the data of an ID range in the active file	123
Figure 6-33	Warning message when resetting measurements	124

Figure 6-34	The MEMORY status screen	124
Figure 6-35	The ID overwrite protection message	125
Figure 6-36	Identifying the ID review screen	126
Figure 6-37	Editing the ID # edit mode	128
Figure 6-38	The message when the edited ID is not in the database	129
Figure 6-39	The FILE SUMMARY report screen	131
Figure 6-40	The FILE SUMMARY report result screen	132
Figure 6-41	The MIN/MAX SUMMARY report screen	132
Figure 6-42	The FILE COMPARISON report screen	133
Figure 6-43	The FILE COMPARISON report result screen	133
Figure 6-44	The ALARM SUMMARY report result screen	134
Figure 6-45	The MIN/MAX SUMMARY report result screen	135
Figure 6-46	Returning to the measurement screen	135
Figure 7-1	Normal differential mode (Waveform option activated)	137
Figure 7-2	The DIFF screen	139
Figure 7-3	Displaying the Min and/or Max thickness (Waveform option activated)	140
Figure 7-4	Example of a HIGH alarm indicator (Waveform option activated)	142
Figure 7-5	Example of a B-scan alarm mode	143
Figure 7-6	YEL (yellow) and RED alarm indicators (Waveform option activated) ..	144
Figure 7-7	Setting up the STANDARD alarm	145
Figure 7-8	Example of a locked function message in the help bar	146
Figure 7-9	The PASSWORD screen	147
Figure 7-10	The LOCKS screen	148
Figure 8-1	The MEAS screen	150
Figure 8-2	The SYSTEM screen	152
Figure 8-3	The COMM screen	155
Figure 9-1	Manually adjusting the gain	158
Figure 9-2	Adjusting the extended blank length	160
Figure 9-3	B-scan example	161
Figure 9-4	Changing B-scan parameters	162
Figure 9-5	B-scan elements	162
Figure 9-6	B-scan freeze review elements	164
Figure 9-7	Example of the half-size DB grid	167
Figure 9-8	Changing DB grid parameters	168
Figure 9-9	Grid transposition example	168
Figure 9-10	Example of a linearized DB grid	169
Figure 9-11	The highlighted DB grid cell in the ID review screen	170
Figure 9-12	Example of an inserted cell	171
Figure 9-13	Example of a zoomed inserted cell	171
Figure 10-1	The ACTIVE screen for the setup of a single element transducer	174
Figure 10-2	Adjusting the waveform parameters	176

Figure 10-3	Mode 1 detection example	178
Figure 10-4	Mode 2 detection example	178
Figure 10-5	Mode 3 detection example	179
Figure 10-6	Detection of the first or the second negative peak	180
Figure 10-7	Comparing pulser powers set to 60 V and 200 V	181
Figure 10-8	The TDG zones and parameters	182
Figure 10-9	Main bang blank position for mode 1	184
Figure 10-10	Main bang blank position for mode 2 and mode 3	185
Figure 10-11	Echo window setting for mode 1	186
Figure 10-12	Echo window setting for mode 2 and mode 3	186
Figure 10-13	Negative and positive echo detection examples	187
Figure 10-14	Examples of the interface blank in mode 2	189
Figure 10-15	Examples of the interface blank in mode 3	190
Figure 10-16	Examples of M3 Blank adjustment	190
Figure 10-17	Saving custom setups	192
Figure 11-1	Connecting the 45MG to a computer	196
Figure 11-2	The EXPORT screen	198
Figure 11-3	Example of the IMPORT screen	199
Figure 11-4	The Device Configuration dialog box	201
Figure 11-5	The Device Tools dialog box with a screen capture	202
Figure 11-6	Selecting COMMUNICATION RESET	204
Figure 12-1	Activating a reset function	209
Figure 12-2	The KEYPAD TEST screen	210
Figure 12-3	The DUAL XDCR TEST screen	211
Figure 12-4	Example of the SW DIAG screen	212
Figure 12-5	Example of the STATUS screen	213

List of Tables

Table 1	Keypad functions	33
Table 2	45MG software options	77
Table 3	Recommended transducers for various steel thickness ranges	84
Table 4	File contents summary	99
Table 5	Additional information stored with the data	101
Table 6	Resulting ID examples for the INCREMENTAL file type	104
Table 7	Resulting ID examples for the SEQUENTIAL file type	106
Table 8	Resulting ID example for the SEQ+CUSTOM PT file type	107
Table 9	Resulting ID example for the BOILER file type	113
Table 10	File data-mode stored measurements	114
Table 11	Polarity of echoes	188
Table 12	Default communication parameter values	203
Table 13	Measurement default settings	207
Table 14	Default communication settings	208
Table 15	Measurement troubleshooting	214
Table 16	General EN15317 specifications	215
Table 17	Display EN15317 specifications	216
Table 18	Transmitter EN15317 specifications	216
Table 19	Receiver EN15317 specifications	216
Table 20	Other EN15317 specifications	216
Table 21	Environmental rating specifications	217
Table 22	Measurement specifications	217
Table 23	Datalogger specifications	218
Table 24	Transducer selection	219
Table 25	Typical ranges and default setups for single element transducers	220
Table 26	Setup parameter description	221
Table 27	General specifications	223
Table 28	Sound velocities in common materials	225
Table 29	Software options	227
Table 30	Accessories and replacement parts	227

Table 31	Interface cables and power accessories	228
Table 32	Couplants	228
Table 33	Test blocks	228