

## Before Use

STM6-CAL22 TEACHING EDITING SOFTWARE system provides the following components.

Make sure that all the components are complete before use this system. If the components may be incomplete and damaged, consult your local Olympus representative.

### COMPONENTS

User's Manual · · · · ·	1
Floppy disk (3.5 inches / 1.44MB) · · · · ·	4
RS-232C cross cable (9-pin female - 9-pin female)	
Dongle (Hardware protect key) · · · · ·	1

# User's Manual

# STM6-CAL22

## TEACHING EDITING SOFTWARE

**【Ver 1.01】**

### Petition

Thank you for adopting TEACHING EDITING SOFTWARE.

To ensure the safety, obtain optimal performance and familiarize yourself fully with this software, we recommend you to study this manual thoroughly before operation.

This user's manual is simply for the STM6-CAL22 TEACHING EDITING SOFTWARE.

To obtain comprehensive knowledge of your microscope system, refer to "User's Manual MM6-AL22".

Retain this manual at accessible place while operating the equipment.

And after reading through, keep this manual with care for future reference.



## **CAUTION**

1. Reproduction, copying or duplication of a part or all of this software and manual is prohibited.
2. The information described in this manual may be subject to change without notice.

## **Registered Trademarks**

Microsoft, Windows are registered trademarks of Microsoft Corporation.



Other brand names and product names are trademarks or registered trademarks of their respective owners.

## NOTATIONS IN THIS MANUAL

## NOTATIONS IN THIS MANUAL

This manual complies with the following notations.

### ✧ Notation of Caution, Notes and Tips

Notation	Description
	Caution to prevent injuries to the user or damage to the product (including surrounding objects).
	Note for the user.
	Hint or one-point advice for user reference.

### ✧ Notation of menu, Command Buttons and Dialog Boxes









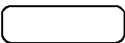

Notation	Description
[END] dialog box	The name of a dialog box, check box, and others are enclosed inside square brackets ([ ]).
<OK> button	The name of a button in a dialog box and MM6-CAL22 key are enclosed inside angle brackets (< >).

### ✧ Notation of Mouse Operations

Notation	Description
clicking	Action of pressing, then immediately releasing the mouse button.
double-clicking	Action of clicking the mouse button twice in quick succession.
dragging	Action of moving the mouse while holding down the mouse button, then releasing the mouse button at the desired destination.

(Note) In this manual, clicking, double-clicking and dragging involves pressing the left button of the mouse, unless otherwise specified.

### ✧ Notation of key operations

Notation	Description
	The name of a key is enclosed inside  .
 + 	The positive sign (+) expresses the combination of more than one key operation. For example,  +  refers to pressing the  key while holding the  key down.
Direction keys	Generic names given to the  ,  ,  and  keys.





(Note) Some of the panels and dialog boxes shown in this manual are not the precise reproductions of the originals. Some windows are resized to facilitate the reading and some grayed-out characters are printed in readable characters.

**REFERENCE TO MANUAL**



**This user's manual is for the STM6-CAL22 TEACHING EDITING SOFTWARE.**  
**See the MM6-CAL22 User's Manual following the notes, "Refer to the MM6-CAL22 User's Manual" in this manual.**

**Operation**

Description of Alignment Items, Measurement Items, Ancillary Functions, and so on.  
 Refer to the "Operation" of the MM6-CAL22 User's Manual.

**Maintenance**

Refer to the "Maintenance" of the MM6-CAL22 User's Manual.

**Specification**

Refer to the "Specifications" of the MM6-CAL22 User's Manual.



<b>1 Initial Settings</b>	<b>1-1</b>
<b>1-1 Basic Operation</b>	<b>1-1</b>
<b>1-2 Setup/Uninstall the Software</b>	<b>1-2</b>
1-2-1 Setup the software	1-2
1 System Requirements	1-2
2 Before Starting Setup	1-3
3 Setup Procedure	1-3
1-2-2 Uninstall the software	1-7
<b>1-3 Attaching the Dongle</b>	<b>1-9</b>
<b>1-4 Connecting the Cable</b>	<b>1-10</b>
1-4-1 Connecting method	1-10
1-4-2 Setting the DIP Switch	1-11
<b>1-5 Turning the MM6-CAL22 power on in Maintenance mode</b>	<b>1-12</b>
<b>1-6 Starting the Software</b>	<b>1-13</b>
<b>1-7 Exiting from the Software</b>	<b>1-14</b>
<b>1-8 Setting the Communication Environment</b>	<b>1-15</b>
1-8-1 Reconnecting the Software	1-16



**2 First Teaching 2-1**

- 2-1 Window Names and Their Control Methods . . . . . 2-1**
- 2-2 Basic Operations . . . . . 2-3**
  - 2-2-1 Off-line Mode Operation . . . . . 2-4
  - 2-2-2 On-line Mode Operation . . . . . 2-5
- 2-3 Examples of Creation and Editing of Teaching Program . . . . . 2-6**
  - 2-3-1 Program Example . . . . . 2-6
  - 2-3-2 Example of Teaching Program Creation in Offline Mode . . . . . 2-8
    - 1 Connecting the dongle. . . . . 2-8
    - 2 Starting the application. . . . . 2-8
    - 3 Selecting the file . . . . . 2-8
    - 4 Creating a new teaching program . . . . . 2-9
    - 5 Exiting from the editing window (Saving the program) . . . . . 2-15
    - 6 Entering or modifying the comment. . . . . 2-16
    - 7 Connecting the MM6-CAL22. . . . . 2-16
    - 8 Downloading the program file . . . . . 2-17
    - 9 Exiting from the application . . . . . 2-19
  - 2-3-3 Example of Teaching Program Editing in Offline Mode . . . . . 2-19
    - 1 Connecting the dongle. . . . . 2-19
    - 2 Starting the application. . . . . 2-19
    - 3 Selecting the file . . . . . 2-19
    - 4 Editing the teaching program . . . . . 2-19
    - 5 Exiting from the teaching program (Saving the program) . . . . . 2-22
    - 6 Modifying the comment. . . . . 2-22
    - 7 Connecting the MM6-CAL22. . . . . 2-22
    - 8 Downloading the program file . . . . . 2-22
    - 9 Exiting from the application . . . . . 2-23
    - 10 Teaching program after editing . . . . . 2-23

2-3-4 Example of Teaching Program Editing in Online Mode .....	2-24
1 Preparations .....	2-24
2 Starting the application. ....	2-24
3 Uploading the program file .....	2-24
4 Selecting the file .....	2-26
5 Editing the teaching program .....	2-27
6 Closing the [Edit] window (Saving the program) .....	2-27
7 Modifying the comment. ....	2-27
8 Downloading the program .....	2-27
9 Exiting from the software .....	2-27
10 After modification of the teaching program .....	2-27



**3 [MAIN] Window 3-1**

- 3-1 Basic Screen Display Items ..... 3-1**
- 3-2 Menu Bar ..... 3-2**
  - 3-2-1 File Menu ..... 3-2
    - 1 Backup ..... 3-2
    - 2 Print List ..... 3-2
    - 3 Exit ..... 3-3
  - 3-2-2 Settings Menu ..... 3-3
    - 1 Set Communication Environment ..... 3-3
    - 2 Set backup directory ..... 3-4
  - 3-2-3 Help Menu ..... 3-5
    - 1 Version ..... 3-5
- 3-3 [Main] Window ..... 3-6**
  - 3-3-1 Remote System Drive and Directory Selection ..... 3-6
    - 1 Selecting the drive name ..... 3-6
    - 2 Selecting the directory ..... 3-6
    - 3 Creating a new folder ..... 3-6
  - 3-3-2 [MM6-CAL22] Teaching Program List ..... 3-7
  - 3-3-3 [Remote System] Teaching Program List ..... 3-8
  - 3-3-4 CLEAR Buttons ..... 3-9
  - 3-3-5 <Upload>/<Download> Buttons ..... 3-10
    - 1 Upload button ..... 3-10
    - 2 <Download> button ..... 3-13
  - 3-3-6 Communication Status Check ..... 3-15

## **4 [EDIT] Window 4-1**

<b>4-1 Basic Screen Display Items</b> .....	<b>4-1</b>
<b>4-2 Menu Bar</b> .....	<b>4-2</b>
4-2-1 File Menu .....	4-2
1 Print List .....	4-2
4-2-2 Edit Menu .....	4-2
1 Delete .....	4-2
2 Copy .....	4-2
3 Paste .....	4-3
4 Undo .....	4-3
5 Modification .....	4-3
4-2-3 Set Menu .....	4-3
1 Unit of Measurement .....	4-3
2 Initial Setup .....	4-4
4-2-4 Help Menu .....	4-5
1 Version .....	4-5
<b>4-3 Toolbar</b> .....	<b>4-6</b>
4-3-1 Delete .....	4-6
4-3-2 Copy .....	4-6
4-3-3 Paste .....	4-6
4-3-4 Undo .....	4-7
4-3-5 Print List .....	4-7
<b>4-4 Edit Window Description</b> .....	<b>4-8</b>
4-4-1 [Alignment] Item Buttons .....	4-8
1 <AL1> to <AL6>, <AL8>, <AL10> to <AL12> buttons .....	4-9
2 <AL7> button .....	4-9
3 <AL9> button .....	4-10
4 <AL13> button .....	4-11
4-4-2 [Measurement] Item Buttons .....	4-12
1 <CL1> to <CL16> and <CL19> buttons .....	4-13
2 <CL17> and <CL18> buttons .....	4-13
4-4-3 [Input Property] Buttons .....	4-14

# CONTENTS



4-4-4 [Auxiliary Function] Buttons .....	4-14
1 <STAT> button .....	4-15
2 <TOLER> button .....	4-17
3 <SAMPL> button .....	4-19
4 <COND> button .....	4-19
5 <OUTSL> button .....	4-21
6 <MULTI> button .....	4-22
7 <MEMWR> button .....	4-23
8 <MEMRD> button .....	4-24
9 <IPCAL> button .....	4-25
10 <PRINT> button .....	4-25
4-4-5 <DATA> Button .....	4-25
4-4-6 <ENT> Button .....	4-25
4-4-7 Teaching Program Editing Situation Display .....	4-26
4-4-8 <OK> Button .....	4-27
4-4-9 <CANCEL> Button .....	4-28
4-4-10 Teaching Program Line List .....	4-29



--

---

## **APPENDIX A ICON LIST** **A-1**

A-1 Alignment Items .....	A-1
A-2 Measurement Items .....	A-3
A-3 Input Types .....	A-6
A-4 Ancillary Functions .....	A-8

## **APPENDIX B Delete, Copy, Paste and Modify** **B-1**

B-1 Delete .....	B-1
B-2 Copy .....	B-3
B-3 Paste .....	B-4
B-4 Modify .....	B-5

## **APPENDIX C SYNTAX DESCRIPTION** **C-1**

C-1 Alignment Items .....	C-1
C-1-1 AL1 .....	C-1
C-1-2 AL2 .....	C-2
C-1-3 AL3 .....	C-2
C-1-4 AL4 .....	C-3
C-1-5 AL5 .....	C-3
C-1-6 AL6 .....	C-4
C-1-7 AL7 .....	C-5
C-1-8 AL8 .....	C-6
C-1-9 AL9 .....	C-6
C-1-10 AL10 .....	C-6
C-1-11 AL11 .....	C-7
C-1-12 AL12 .....	C-7
C-1-13 AL13 .....	C-7
C-2 Measurement Items .....	C-8
C-2-1 CL1 .....	C-8
C-2-2 CL2 .....	C-8
C-2-3 CL3 .....	C-9

# CONTENTS



C-2-4 CL4	C-9
C-2-5 CL5	C-10
C-2-6 CL6	C-10
C-2-7 CL7	C-11
C-2-8 CL8	C-11
C-2-9 CL9	C-12
C-2-10 CL10	C-12
C-2-11 CL11	C-13
C-2-12 CL12	C-13
C-2-13 CL13	C-14
C-2-14 CL14	C-14
C-2-15 CL15	C-15
C-2-16 CL16	C-15
C-2-17 CL17	C-16
C-2-18 CL18	C-16
C-2-19 CL19	C-17
<b>C-3 Input Property</b>	<b>C-17</b>
<b>C-4 Auxiliary Functions</b>	<b>C-18</b>
C-4-1 STAT (Statistics)	C-18
C-4-2 TOLER (Tolerance)	C-18
C-4-3 SAMPL (Sample Number)	C-19
C-4-4 COND (Condition)	C-19
1 Comment	C-19
2 Date setting	C-19
3 Buzzer volume	C-19
C-4-5 OUTSL (Output Selection)	C-20
C-4-6 MULTI (Multipoint)	C-20
C-4-7 MEMWR (Memory Write)	C-20
C-4-8 MEMRD (Memory Read)	C-21
C-4-9 IPCAL (Input Point Calculation)	C-21
C-4-10 PRINT	C-21





# 1 Initial Settings

## 1-1 Basic Operation

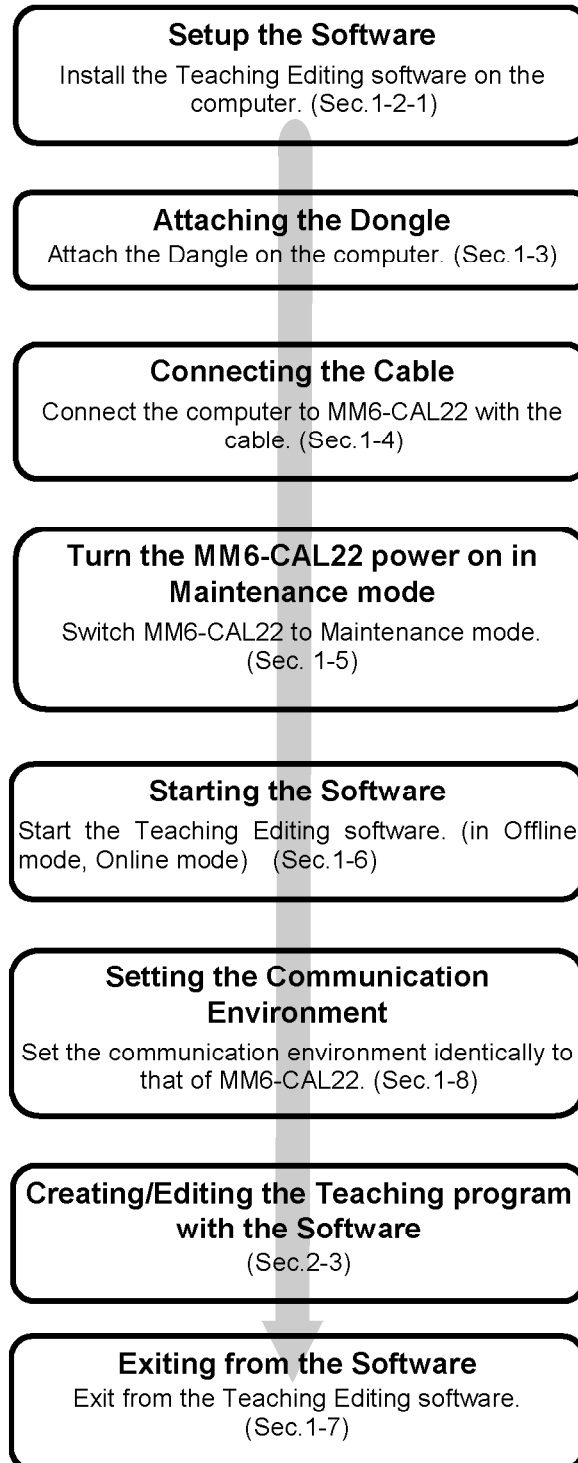

## 1-2 Setup/Uninstall the Software

Follow the procedures described below to setup the Teaching Editing software. And uninstall the software only when the deletion of the Teaching Editing software from the computer is required.

### 1-2-1 Setup the software

#### 1 System Requirements

---

To operate the Teaching Editing software, the following software and hardware are required.

- Software

Microsoft Windows 98 of Japanese version, or English version

- Required available space in RAM and Hard disk

RAM : 32MB or more

Available space in Hard disk : 5MB or more

- Hardware (Indispensable)

PC : IBM compatible

I/O device : Communication port (COM1 or COM2), Parallel port, and Floppy disk drive

CPU : INTEL 80486DX2/66MHz or higher processor, Pentium processor, or other compatible processor

Display : More than 800X600 pixels resolution, in more than 16 colors

Display adapter : Windows recommendations

Pointing device : Microsoft Mouse, or compatible pointing device

Keyboard : Windows recommendations

Dongle : The accessory of the MM6-CAL22 system

## 2 Before Starting Setup

---

- Required available space in HD

For installation, in addition to 5MB (required as operating condition), 2.5MB or more should be available. (This space is used for Temporary file at installation and deleted when the installation completes).

- Client-access licenses

Confirm that the client-access licenses exists in the followings to setup and startup the Teaching Editing software properly on Windows 98.

- The folder to install the Teaching Editing software
- Windows system folder
- System registry

## 3 Setup Procedure

---

1. Load the first setup floppy disk of Teaching Editing Software in the FD drive.
2. Click the <Start> button on the task bar to display the [Start] menu, then select the [Run] command. The [Run] dialog box as shown below appears.



3. Click the <Browse> button. The [Browse] dialog box appears. Select drive (A:) as the file location and select file "Setup". Then click the <Open> button to return to the [Run] dialog box.
4. Confirm that "A:\Setup.exe" is displayed in the [Run] dialog box and click the <OK> button.



5. The displayed dialog box describes the “Program Usage Licensing Agreement”. And significant information about the permission of the software use is described in the “Program Usage Licensing Agreement”. Be sure to read through the “Program Usage Licensing Agreement” before opening this software system.
6. When the [Choose Destination Location] dialog box appears, click the <Next> button.

**TIP** Clicking the <Browse> button changes the destination location.



7. The [Setup Type] dialog box appears. Then select “SetUp” and click the <Next> button.

**TIP** Select “Version Up” when the Teaching Editing software is already installed. Selecting “Version Up” follows the setting of the installed Teaching Editing software as far as possible.





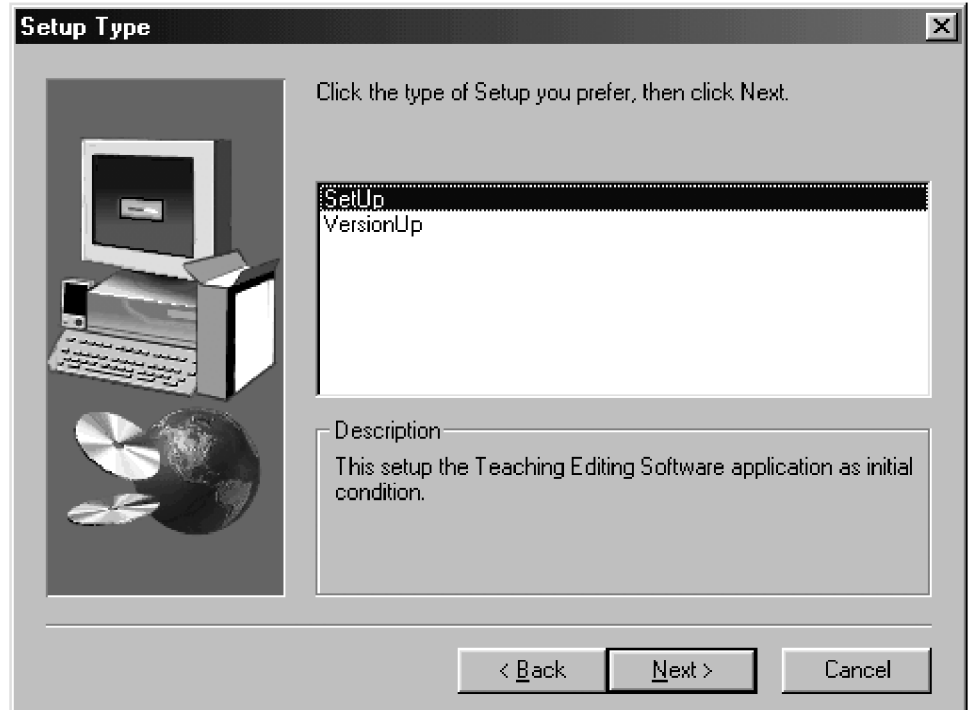

8. When the [Select Program Folder] dialog box appears, usually do nothing but click the <Next> button. The setup will start.



9. Replacement of the floppy disk is required during the setup. Follow the instructions on the display.



10. After completion of the setup, the [Setup Complete] dialog box appears. Eject the Teaching Editing software setup floppy disk from the FD drive, then select “Yes, I want to restart my computer now.” and click the <Finish> button.



## 1-2-2 Uninstall the software

1. Select the <Start> button on the task bar to display the [Start] menu, then select the [Settings] and click the [Control Panel].
2. Select [Add/Remove Programs] in the [Control Panel] dialog box. The [Add/Remove Programs Properties] dialog box as shown below appears.

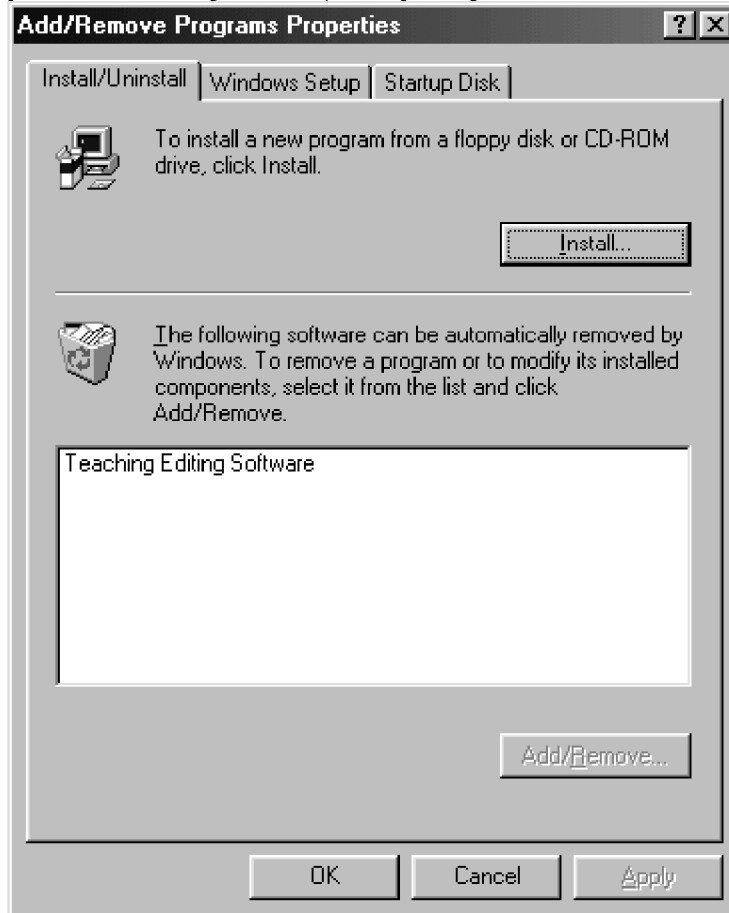

3. In the list of installed software programs, select "Teaching Editing Software" and select the <Add/Remove> button. When the confirming message is displayed, select the <Yes> button.



4. The [Remove Programs From Your Computer] dialog box appears and removal of the software starts. When the message "Uninstall successfully completed" is displayed, select the <OK> button.



5. When the [Add/Remove Program Properties] is displayed again, select the <OK> button.

### 1-3 Attaching the Dongle

A dongle is included in the Teaching Editing software components. The Teaching Editing software cannot start unless the dongle is attached to the computer.



**Do not attach or remove the dongle when the power of the computer turns ON. Otherwise, the dongle may be damaged and make it impossible to start the Teaching Editing software.**

1. Make sure that the power switch of the computer is set to OFF.
2. Insert the dongle into the parallel connector on the rear of the computer. Tighten the 2 screws of the dongle to secure it firmly. To remove the dongle, loose the 2 screws and pull the dongle off.

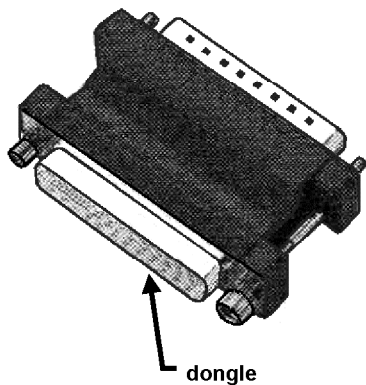

**Attach the dongle to the parallel port. It may be impossible to communicate with MM6-CAL22 if the dongle is attached to another port.**

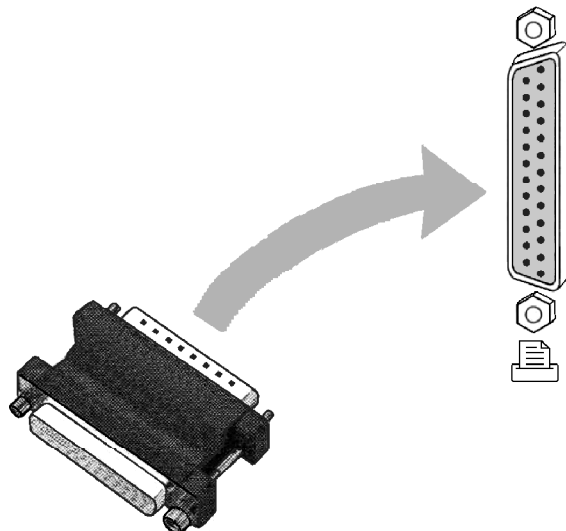

The printer cable should be connected via the dongle.



If the dongle of another system has already been attached, see the manual of another system for the order of dongle attachment. (The dongle of another system may be subject to the attachment order while the Teaching Editing software dongle is not effected by the order.)



Refer to your computer manual for the location of the parallel port.

## 1-4 Connecting the Cable

### 1-4-1 Connecting method

Connect the cables after the dongle attachment is completed.



Take care on the following points when connecting an external computer.

1. With the DIP switch ②, set the communication rate, parity bits, bit length and line delimiters for the Teaching Editing software. See “Section 1-4-2” for further details.
2. Use an RS232C cable (cross cable) for connection.
3. As the flow control is not applied, reduce the communication rate if the data received at the computer lacks.

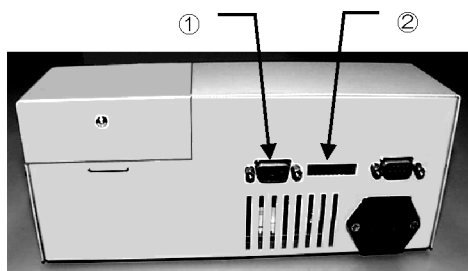

Fig. 1-1

1. Ensure that the power switches of MM6-CAL22 and the computer are set to OFF.
2. Insert the end of the serial cable D-SUB 9-pin into the connector ① on the MM6-CAL22 rear panel (Fig. 1-1) and the other end to the parallel port of the computer. (See your computer manual for the location to be connected to.)



**TIP**

Use the conversion connector for connection if the connector configuration of the COM port is not D-SUB 9-pin (male). To set the conversion connector, it is required that each pin correspond to the connection of the cross cable depending on the conditions of the serial communication cable and conversion connector.

**1-4-2 Setting the DIP Switch**

The following tables show the details of the DIP switch (Fig.1-1, ②) tabs and the available communication rates. The settings described here should correspond to the communication settings of the Teaching Editing software (See Section 1-8).

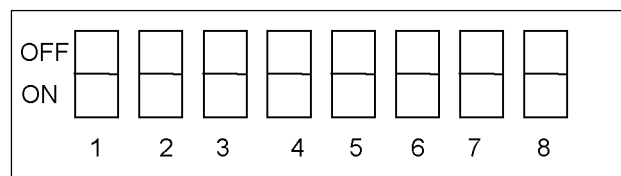

	1	2	3	4	5	6	7	8
	EXT Port baud rate		EXT Port parity		EXT port bit length	EXT port terminator	Start area selection	Language selection
	Communi- cation rate	Communi- cation rate	Parity	Parity	Bit length	Delimiter	Not used	Language selection
OFF	See table below		Odd	Parity	7bit	CR	Permanen- tly On.	English
ON			Even	No Parity	8bit	CR+LF		Japanese <i>katakana</i>

1	2	Communication Rate
OFF	OFF	2400 bps
ON	OFF	4800 bps
OFF	ON	9600 bps
ON	ON	19200 bps

- The stop bit is fixed per 1 bit.
- The unit is unchanged if the displayed language is switched from Japanese to English.
- Resetting is enabled after the MM6-CAL22 power switch is set to OFF and to ON again.

## 1-5 Turning the MM6-CAL22 power on in Maintenance mode

It is impossible to communicate the Teaching Editing software with MM6-CAL22 simply by turning the MM6-CAL22 power on. To communicate with MM6-CAL22, switch to Maintenance mode when turning the power on. The operating procedure is described below.

1. Turn the MM6-CAL22 power on in Maintenance mode. Set the MM6-CAL power switch to "I" (ON) holding down the <RESET> key.

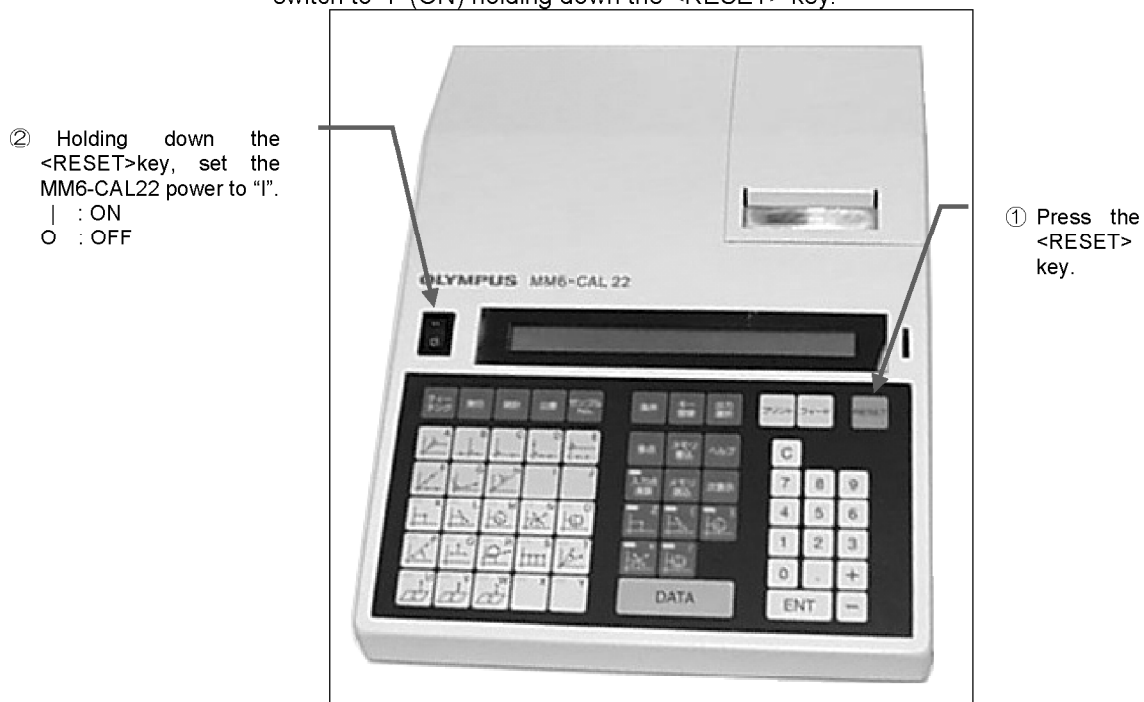

Fig. 1-2

2. Release the <RESET> key 5 second later than the initial screen is displayed on the MM6-CAL22 display. Then, the message of Maintenance mode appears. This condition is Maintenance mode.

If any of the measurement items appears in the display, it means that switching to Maintenance mode fails. In this case, follow the step1 to 2 once more.

\*\*\* OLYMPUS MM6-CAL22 Ver.01.03 \*\*\*

The initial screen on the MM6-CAL22 display

MAINTENANCE MODE PC CONNECTING

Maintenance mode on the MM6-CAL22 display



**NOTE**

In Maintenance mode, MM6-CAL22 is not available. Note that the data of STM6 is not loaded in MM6-CAL22.

3. Turn the switch of the computer on to start up Windows 98.

## 1-6 Starting the Software



The <Teaching Editing software> icon

1. Login to Microsoft Windows 98.
2. Double-click the <Teaching Editing software> icon on the desktop.
3. The [Main] Window appears when the Teaching Editing software starts. In Online mode (connected with MM6-CAL22), the [Main] Window appears (Fig.1-3). In Offline mode (disconnected with MM6-CAL22), the confirming message (Fig. 1-4) appears in addition to the [Main] Window. Click the <OK> button to close the message box.

**TIP**

- Clicking the <Start> button on the task bar also starts the Teach Editing software.
- According to the user setting, a part of window may be disappeared when using this software in 800X600 desk-top size. In case, position the window to be visible.

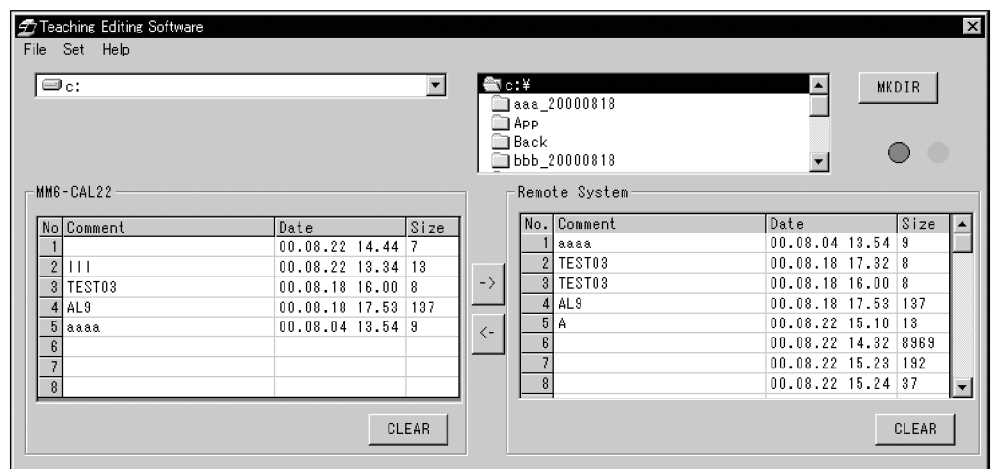

Fig. 1-3

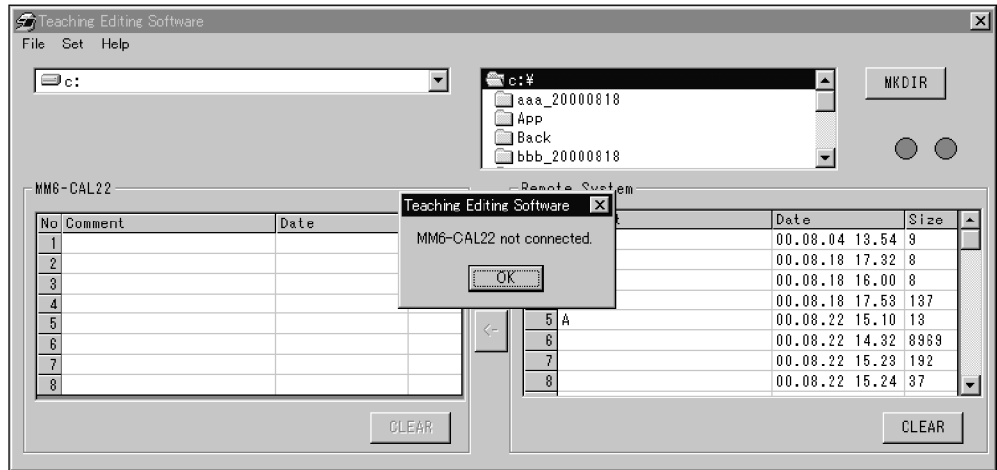

Fig. 1-4



In Offline mode, the functions of Upload/Download, and Backup are not available. Connect with MM6-CAL22 to use these functions.

## 1-7 Exiting from the Software

Exit from the Teaching Editing software.

1. Select the [END] in the [FILE] menu. Then, the [END] dialog box appears.

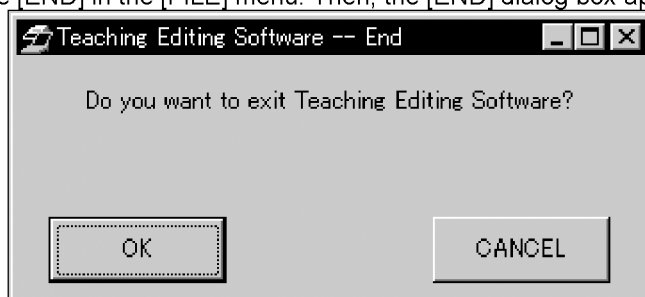

2. Click the <OK> button to exit from the Teaching Editing software.
3. To execute the measurement, set MM6-CAL22 back to the ordinary mode. Turning the MM6-CAL22 power on once more or pressing the <RESET> key returns back to the ordinary mode. It is impossible to execute the measurement when MM6-CAL22 is set to Maintenance mode.

## 1-8 Setting the Communication Environment

### Set

Set Communication Environment  
Set Backup Directory

Set the operating conditions to communicate with MM6-CAL22.

Startup the Teaching Editing software to display the [Main] Window. Then, select the [Set Communication Directory] in the [set] menu.

Set the environment in the [Connect] dialog box. These settings should correspond to those of the communication environment of MM6-CAL22. (Section 1-4-2). The partly different dialog box appears according to the communication with MM6-CAL22. When the Teaching Editing software is not connected with MM6-CAL22, clicking the <Connect> button connects it with MM6-CAL22 after the settings complete.

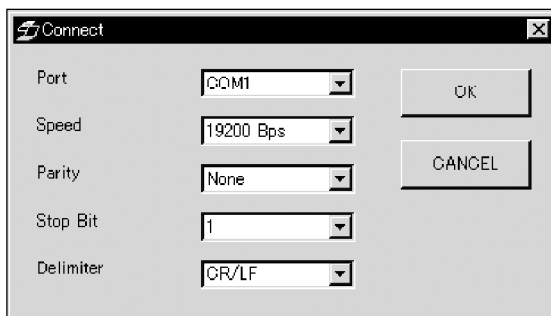

Communicated with MM6-CAL22

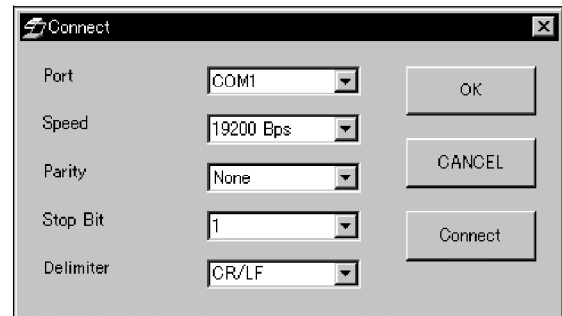

Not communicated with MM6-CAL22

- Port : Set the serial port on the computer. Select either COM1 or COM2.
- Speed : Set the transmission rate for the serial communication. Select the one, 19200bps, 9600bps, 4800bps, or 2400bps.
- Parity : Set the parity check for the serial communication. Select None, Odd, or Even.
- Stop Bit : Set the stop bit for the serial communication. Select either 1 or 2.
- Delimiter : Set the delimiter for the serial communication. Select either CR/LF or CR.
- <OK> button : This saves the communication settings and closes the [Connect] dialog box.
- <CANCEL> button : This cancels the save of the modified communication settings and closes the [Connect] dialog box.
- <Connect> button : This is displayed in the disconnection with MM6-CAL22. Clicking the <Connect> button starts the reconnection with MM6-CAL22. If the reconnection is failed, the error message appears.



The initial settings are as followings :  
Port : COM1, Speed : 19200bps, Parity : None, Stop Bit : 1, and Delimiter : CR/LF.

### 1-8-1 Reconnecting the Software



Execute reconnection in the condition :  
1. When connecting with MM6-CAL22 is required after using the Teaching Editing software in the disconnection mode.  
2. When the connection with MM6-CAL22 is failed.

1. When the connection with MM6-CAL22 is failed, the message of communication error appears on the computer display. Click the <OK> button to close the message box.
2. Attach the dongle and connect the cable. (See "Section1-3 Attaching the Dongle" and "Section1-4 Connecting the Cable" for further details).
3. Set the MM6-CAL22 power to "I" (ON). (See "Section1-5".)
4. Select the [Set] - [Set Communication Environment] in the menu bar in the [Main] Window. Then, the [Set Communication Environment] dialog box (Fig. 1-5) appears. Set every communication conditions corresponding to that of the MM6-CAL22 Dip Switch. (See "Section1-8" for further details.)

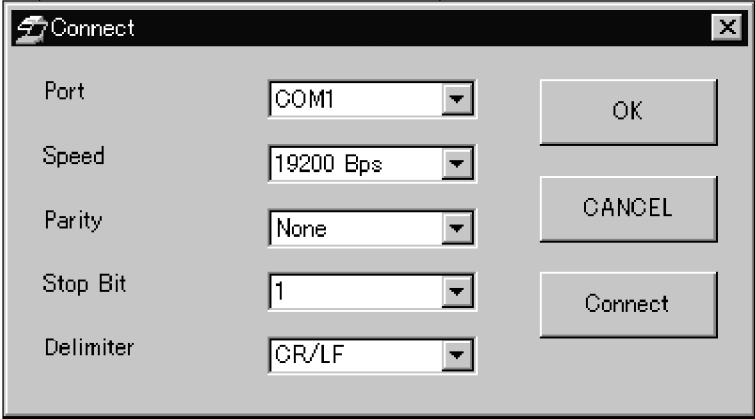

Fig. 1-5

5. Click the <Connect> button when the modification completes. Reconnecting is started following the modified communication settings.



# 2 First Teaching

## 2-1 Window Names and Their Control Methods

This section describes the names of the windows and the outline of their operation methods.

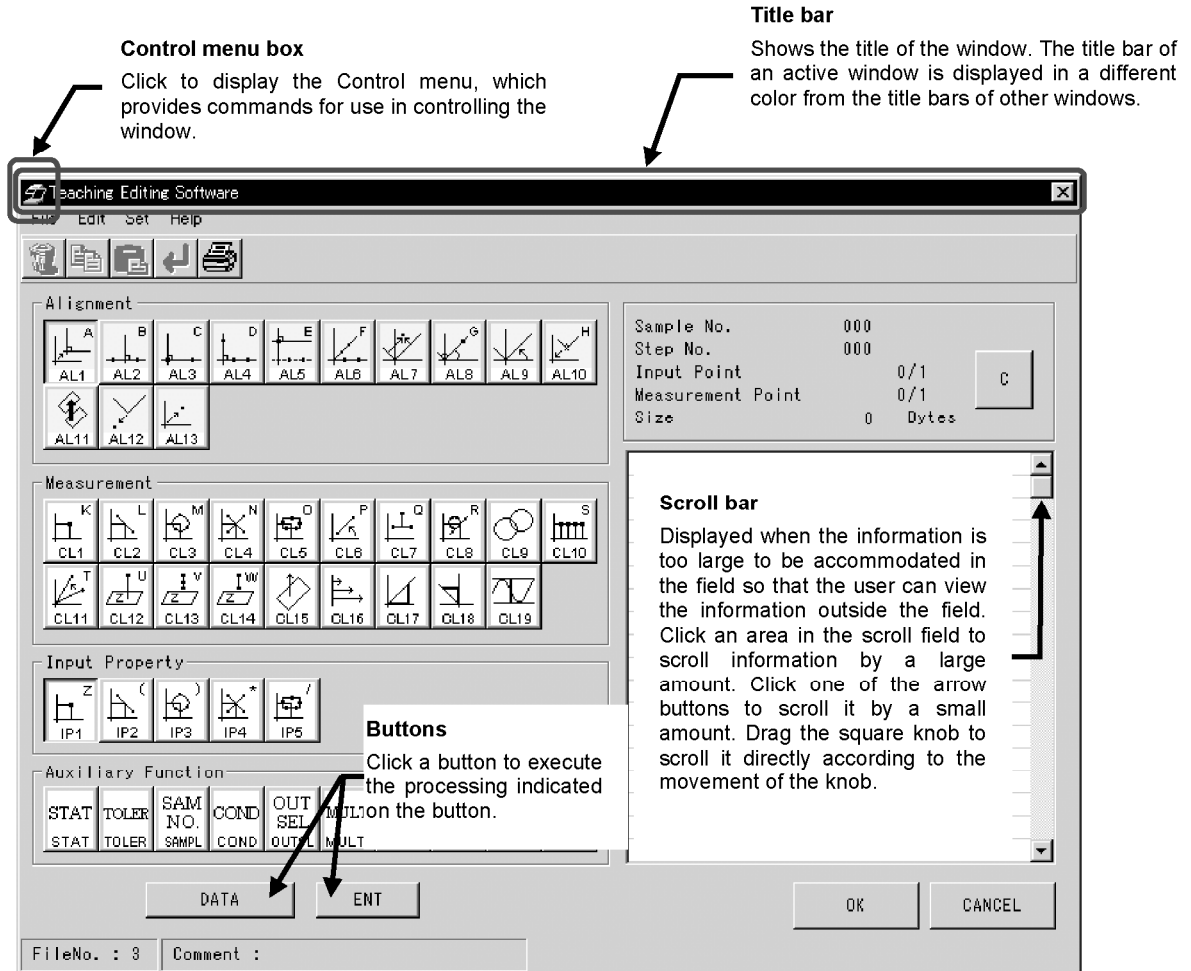

Fig. 2-1 Window and Main Functions



**Option buttons**  
Shows the items from which the user can select only one item. Click the circular button to select the item described on its right. The selected button is indicated by the black dot inside one of the option buttons.

**Group box**  
Refers to a group of functions related to a specific function and displayed inside a box.

**Text box**  
A field accepting direct entry of characters, a value, etc.

Fig. 2-2 Dialog Box and Main Functions

**Drop-down list**  
A list of available options, displayed by clicking ▾. Click one of the items in the list to select the item.

**Check box**  
Click the box to enable or disable the item described on the right. The item is enabled when the check mark (✓) is shown in the box.

Fig. 2-3 Dialog Box and Main Functions

## 2-2 Basic Operations

The teaching program editing software is capable of editing teaching programs saved in the MM6-CAL22 on a PC or saving teaching programs (a maximum of 8 files) which has been created on the PC in the MM6-CAL22. This section shows the basic teaching program editing/creation flow in off-line mode (i.e. when the MM6-CAL22 is not connected) and that in on-line mode (i.e. when the MM6-CAL22 is connected).

**2-2-1 Off-line Mode Operation**

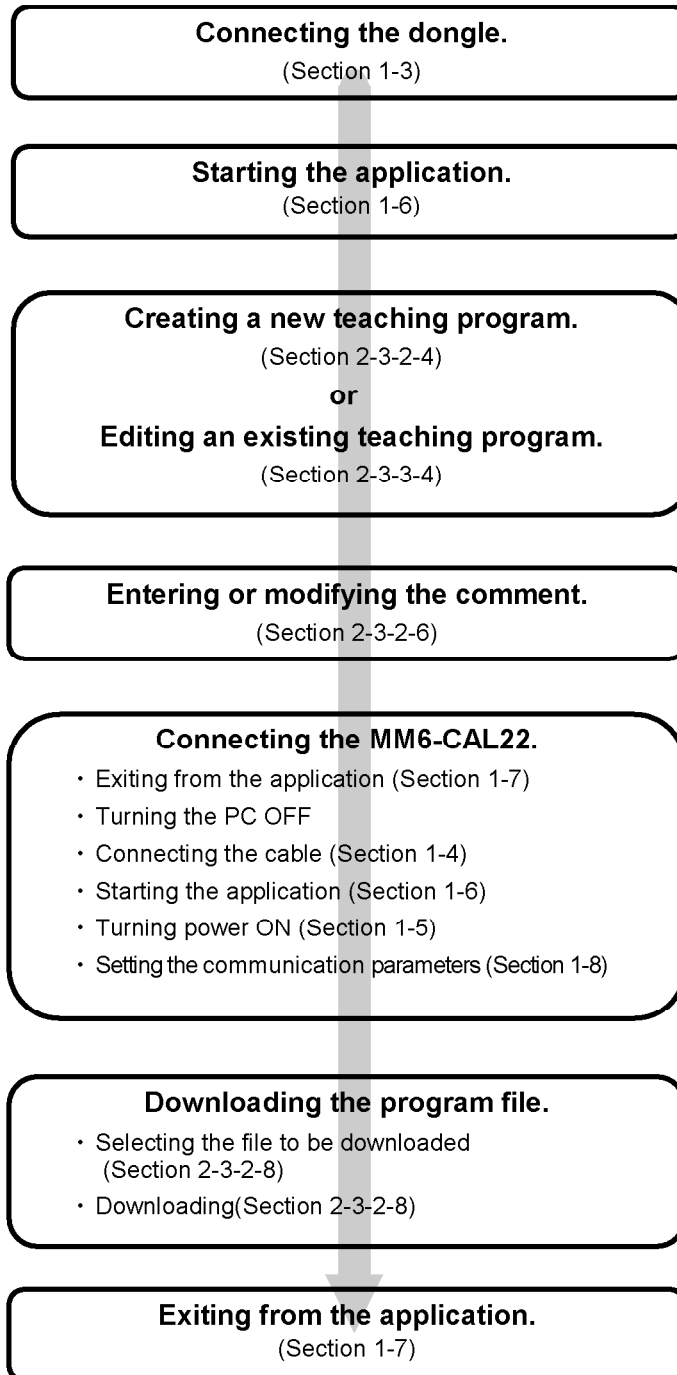



**2-2-2 On-line Mode Operation****Preparations.**

- Connecting the dongle (Section 1-3)
- Connecting the cable (Section 1-4)
- Turning power ON (Section 1-5)
- Setting the communication environment (Section 1-8)

**Starting the application.**

(Section 1-6)

**Uploading the file.**

- Selecting the file uploading destination (Section 2-3-4-3)
- Selecting the file to be uploaded (Section 2-3-4-3)
- Uploading (Section 2-3-4-3)

**Creating a new teaching program.**

(Section 2-3-2-4)

or

**Editing an existing teaching program.**

(Section 2-3-3-4)

**Modifying the comment.**

(Section 2-3-2-6)

**Downloading the file.**

- Selecting the file to be downloaded (Section 2-3-2-8)
- Downloading (Section 2-3-2-8)

**Exiting from the application.**

(Section 1-7)

## 2-3 Examples of Creation and Editing of Teaching Program

This section describes the methods for newly creating a teaching program in offline mode (i.e. when the MM6-CAL22 is not connected to the PC) (section 2-3-2), editing an exiting program file in offline mode (section 2-3-3) and editing a teaching program in online mode (when the MM6-CAL22 is connected) (section 2-3-4) by using some examples.

Try editing operation by using the following program example as the program to be newly created or as the existing program.

### 2-3-1 Program Example

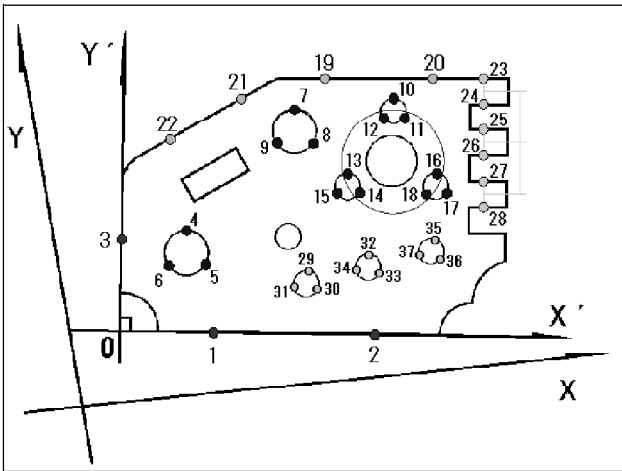

This program was created using the test piece (Fig. 2-4) provided with the MM6-CAL22.



For details on the program context, see "Appendix C".

Fig. 2-4

LineNo.	Teaching Program List	Description
1	IPCAL,1	Cancels input point calculation.
2	MULTI,1	Cancels multipoint setting.
3	OUTSL,1,99,ENT	Selects the output destination. It is the internal printer and the entire measurement results will be printed.
4	TOLER,1,98,4, +0004.0000,+0000.5000,-0000.5000	Writes a tolerance judgment result in a file No98. The judgment whether the measurement result of "R" is within the tolerance range defined by standard value of +4.0, upper tolerance limit of +0.5 and lower tolerance limit of -0.5.

LineNo.	Teaching Program List	Description
5	TOLER,1,99,6, +150.00.00,+001.00.00,-001.00.00	Write a tolerance judgment result in a file No99. The judgment whether the measurement result of "A" is within the tolerance range defined by standard value of +15°, upper tolerance limit of +1° and lower tolerance limit of -1°.
6	AL4 IP1 IP1 IP1	Executes alignment (measurement points 1 to 3 in Fig. 2-4).
7	OUTSL,1,1,2,3,5,6,7,8,9,10,11,12,13,14,15,ENT	Selects the output destination. It is the internal printer but the output of measurement results of except "R" is inhibited.
8	CL3 IP1 IP1 IP1	Measures a circle (measurement points 4 to 6 in Fig. 2-4).
9	TOLER,2,98	Executes tolerance judgment. The judgment is made based on the contents of file No. 98.
10	CL3 IP1 IP1 IP1	Measures a circle (measurement points 7 to 9 in Fig. 2-4).
11	TOLER,2,98	Executes tolerance judgment. The judgment is made based on the contents of file No. 98.
12	CL3 IP3 IP3 IP3	Measures a circle (measurement points 10 to 18 in Fig. 2-4).
13	OUTSL,1,1,2,3,4,5,7,8,9,10,11,12,13,14,15,ENT	Selects the output destination. It is the internal printer but the output of measurement result of except "A" is inhibited.
14	CL4 IP1 IP1 IP1 IP1	Measures the angle formed by two lines. The input property is 1-input point (measurement points 19 to 22 in Fig. 2-4).
15	TOLER,2,99	Executes tolerance judgment. The judgment is made based on the contents of file No. 99.
16	OUTSL,1,1,2,3,4,5,6,7,8,9,10,11,12,14,15,ENT	Selects the output destination. It is the internal printer but the output of measurement result of except "dY" is inhibited.
17	CL10 IP2 IP2 IP2 ENT	Measures the pitch (measurement points 23 to 28 in Fig. 2-4).

**2-3-2 Example of Teaching Program Creation in Offline Mode**

**1 Connecting the dongle.**

Connect the dongle. See section 1-3 for the connection procedure.

**2 Starting the application.**

Start the teaching program editing software. See section 1-6 for the startup procedure.

**3 Selecting the file**

1. From the Main window (Fig. 2-5), select the drive name where you want to save the newly created program.
2. Select the directory you want to save the program. (To create a new directory, see section 3-3-1-3.)
3. Select the number of the created file from the [Remote System] teaching program list. Since the number of a newly created file should be selected, select a number with which no program is saved (i.e. select a number with which Comment, Date and Size are blank). Note that the number can be changed any time after the file has been saved. See section 2-3-2-5 for details. Now, double-click the selected number to display the [Edit] window (Fig. 2-6) on the screen.

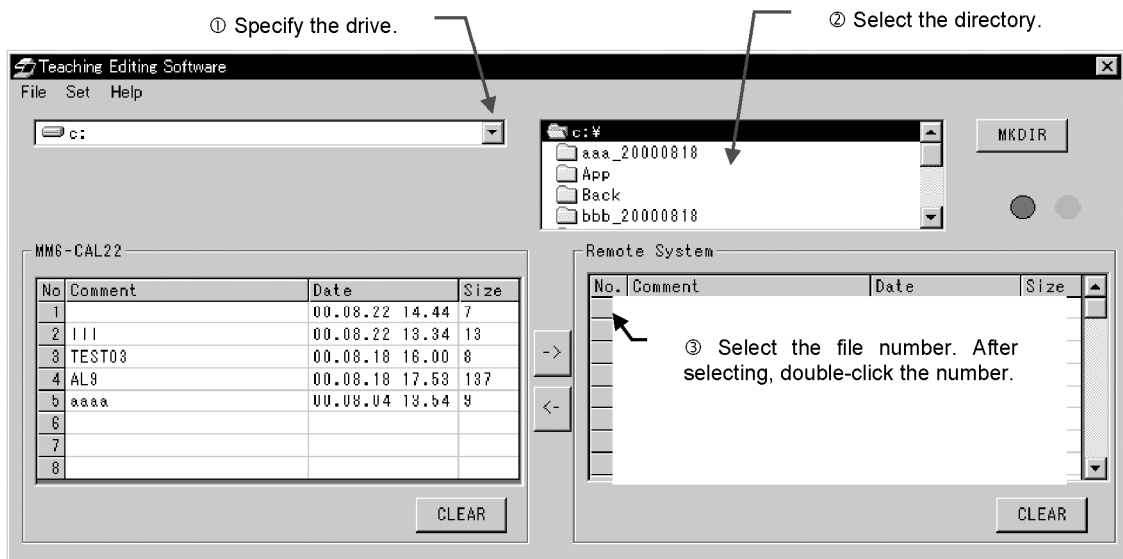

Fig. 2-5

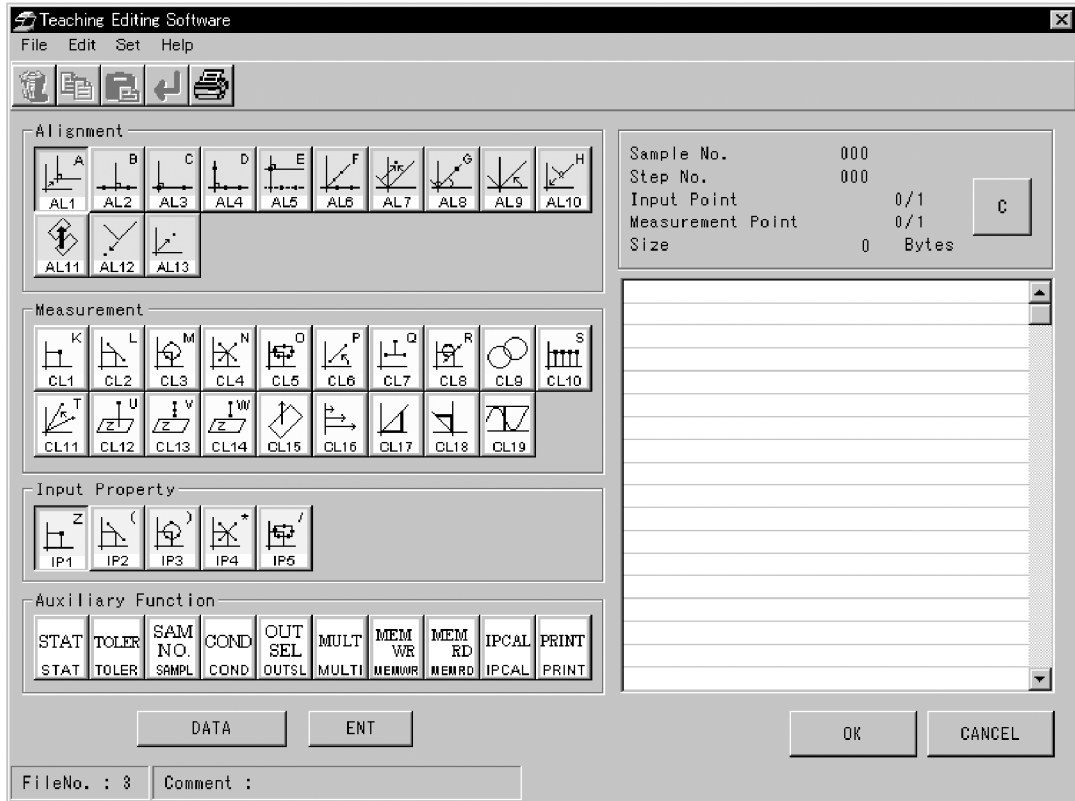

Fig. 2-6

#### 4 Creating a new teaching program

Write line numbers 1 to 9 in the program example shown in section 2-3-1. The teaching program line list in the [Edit] window can be created as described below.

- Initial setup
  - “IPCAL,1” (Cancel input point calculation setting)
  - “MULTI,1” (Cancel multipoint measurement)

Perform the initial setup before newly creating or editing a teaching program. If input point calculation or multipoint measurement has been used before the program listed in the teaching program line list, the teaching program will be created or edited based on the previously made setting, which may lead to inconsistency in the program. To prevent inconsistency in the input point calculation and multipoint measurement, be sure to perform the initial setup.

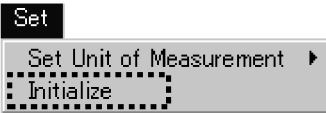
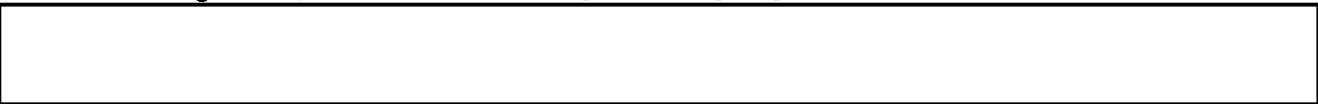

Select [Initialize] from the [Set] menu in the [Edit] window. The [Initialization] dialog box will appear.

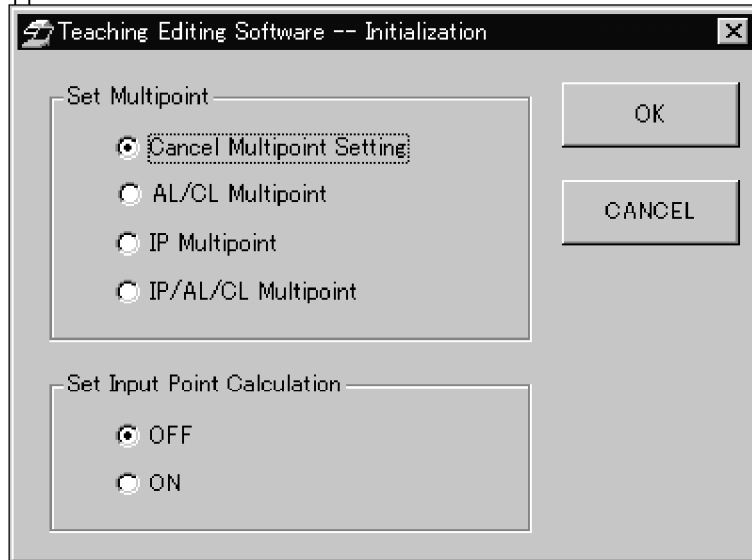

[Set Multipoint] group box: Select "Cancel Multipoint Setting".

[Set Input Point Calculation] group box: Select "OFF".

Click the <OK> button to close the dialog box.



<OUTSL> button

- "OUTSL,1,99,ENT" (Output selection setting)

Click the <OUTSL> button to display the [Output Selection] dialog box.



Select "Internal printer" from the [Output Device] drop-down list and click the <Output All> button in the [Prohibitive items] group box. Then click the <OK> button to close the dialog box.

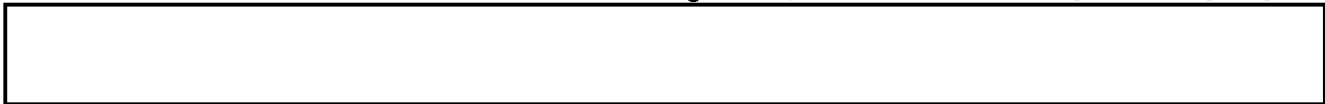

<TOLER> button

- "TOLER,1,98,4,+0004.0000,+0000.5000,-0000.5000 (Tolerance judgment setting)

Click the <TOLER> button to display the [Tolerance Judgment] dialog box.

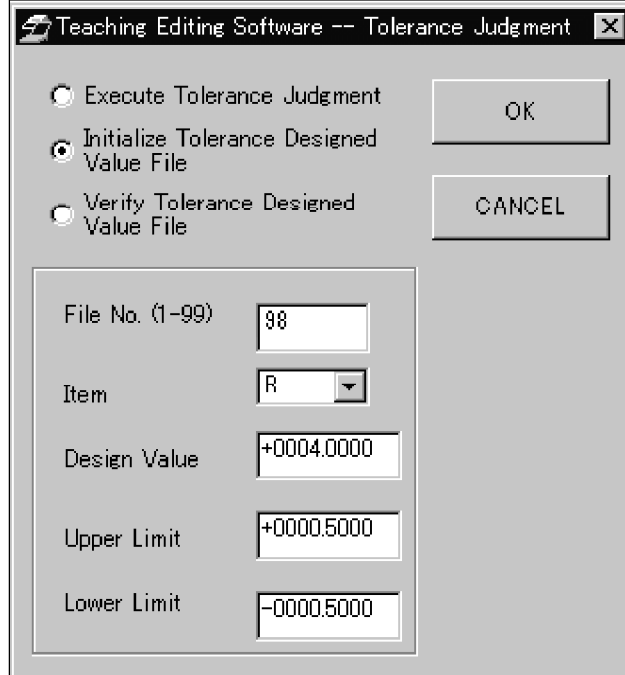

Select "Initialize Tolerance Designed Value file" and perform the following settings.

[File No.] text box: Enter "98".

[Item] drop-down list: Select "R".

[Design Value] text box: Enter "+0004.0000".

[Upper Limit] text box: Enter "+0000.5000".

[Lower Limit] text box: Enter "-0000.5000".

Click the <OK> button to close the dialog box.

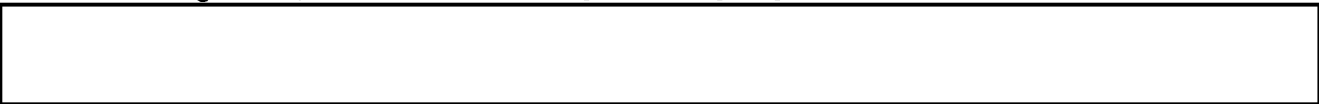

- "TOLER,1,99,6,+150.,00.00,+001.00.00,-001.00.00 (Tolerance judgment setting)

Click the <TOLER> button to display the [Tolerance Judgment] dialog box.



<TOLER> button

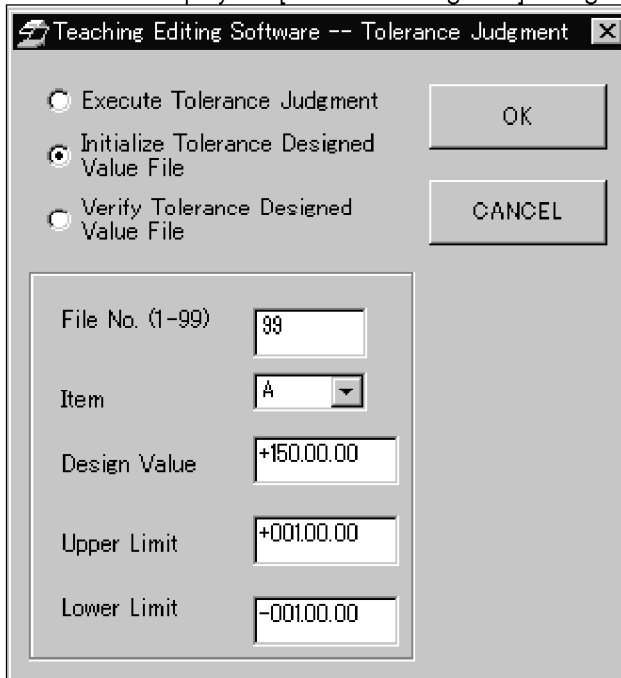

Select "Initialize Tolerance Designed Value file" and perform the following settings.

[File No.] text box: Enter "99".

[Item] drop-down list: Select "A".

[Design Value] text box: Enter "+150.00.00".

[Upper Limit] text box: Enter "+001.00.00".

[Lower Limit] text box: Enter "-001.00.00".

Click the <OK> button to close the dialog box.





<AL4> button



<IP1> button



<DATA> button

● “AL4 IP1 IP1 IP1” (Alignment item setting)

Click the <AL4> button so that the button is displayed in the pressed-in position. Then click the <IP1> button and click the <DATA> button 3 times. The <AL4> button display will change to the out position display.



<OUTSL> button

● “OUTSL,1,1,2,3,5,6,7,8,9,10,11,12,13,14,15,ENT” (Output selection setting)

Click the <OUTSL> button to display the [Output Selection] dialog box.

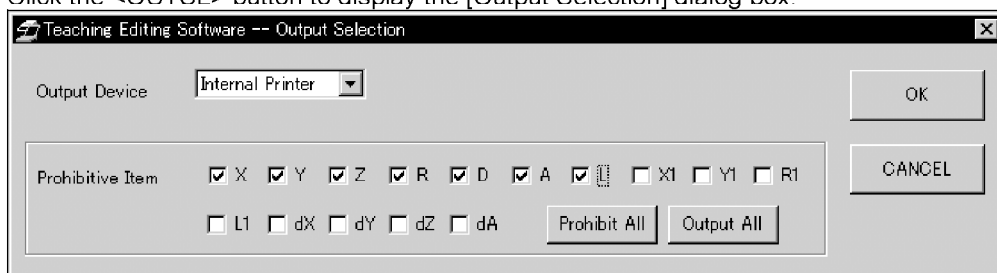

Select [Internal printer] from the [Output Device] drop-down list, then click check boxes except “R” in the [Output inhibited items] group box to remove the check marks in the boxes. Then click the <OK> button to close the dialog box.



<CL3> button



<IP1> button



<DATA> button

● “CL3 IP1 IP1 IP1” (Measurement item setting)

Click the <CL3> button so that the button is displayed in the pressed-in position. Then click the <IP1> button and click the <DATA> button 3 times. The <CL3> button display will change to the out position display.



<TOLER> button

- "TOLER,2,98" (Tolerance judgment execution)

Click the <TOLER> button to display the [Tolerance Judgment] dialog box.

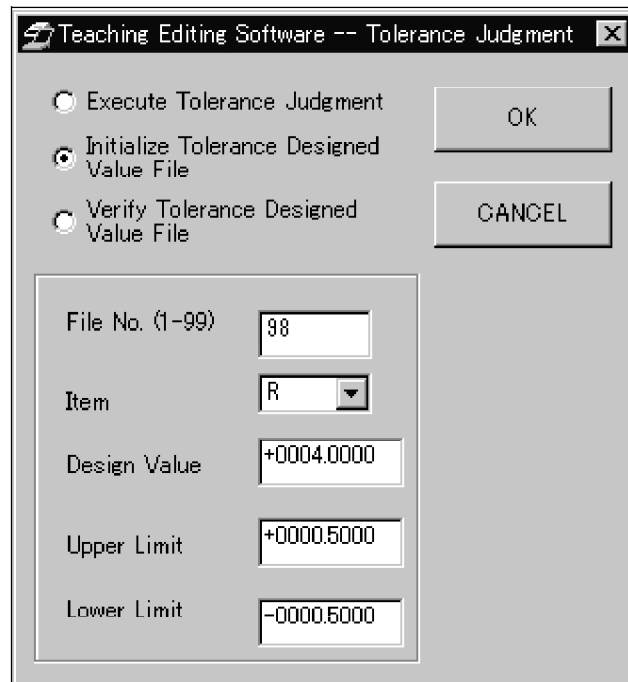

Select "Execute Tolerance Judgment" and enter "98" in the [File No.] text box. Then click the <OK> button to close the dialog box.

## 5 Exiting from the editing window (Saving the program)

To exit from the teaching program by saving the created program, click the <OK> button in the [Edit] window to display the [Select File No.] dialog box.

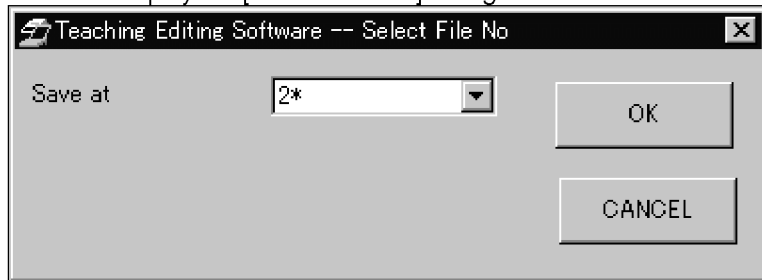

Select the file number to be used (saved file number) from the [Save at] drop-down list. The file number can be selected from numbers 1 to 128. Asterisk "\*" on the top right of a number indicates that there is a program saved with that number. To save the file, click the <OK> button.

If a program already exists in the selected file number, the [Check Overwrite] dialog box appears.

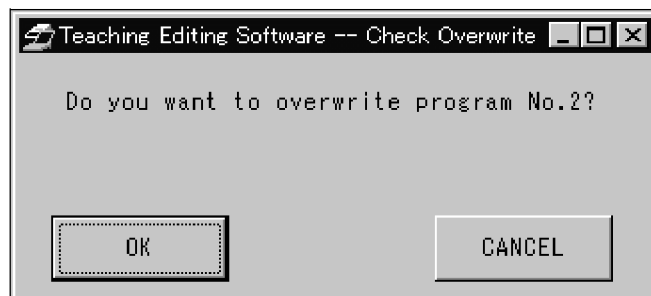

Click the <OK> button to overwrite the existing teaching program.

Click the <CANCEL> button to cancel overwriting.

When the above operation has completed, the [Edit] window closes and the [Main] window re-appears.



## 6 Entering or modifying the comment.

Comment can be entered in the created program using the [Edit] window.

1. Select the file number of the created program and double-click the mouse in the "Comment" column.

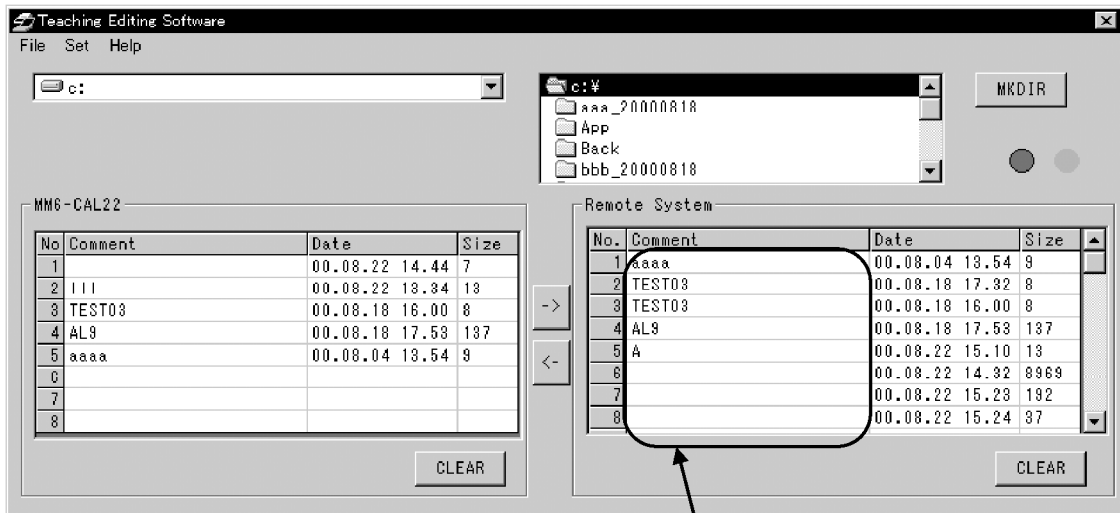

Double-click the mouse in the "Comment" column of the program No. you want to enter comment.

2. Enter comment, which can be entered using up to 24 alphanumeric and Japanese *katakana* characters.

## 7 Connecting the MM6-CAL22.

1. To prepare for the connection of the MM6-CAL22, exit from the application and turn the PC off (see section 1-7).
2. Connect the cable. See section 1-4 for the connection procedure.
3. Turn the MM6-CAL22 ON in the maintenance mode, then turn the PC on. See section 1-5 for the procedure for turning the MM6-CAL22 ON.
4. Start up the application (See section 1-6).
5. Set the communication environment. See section 1-8 for the setting procedures.



## 8 Downloading the program file

Downloading makes it possible to transfer a program file edited on the remote system to the MM6-CAL22.

### Downloading:

In this manual, downloading always refers to transferring a teaching program saved in the [Remote System] teaching program list to the MM6-CAL22.



**NOTE** Make sure to connect the MM6-CAL22 to the PC before proceeding to downloading.

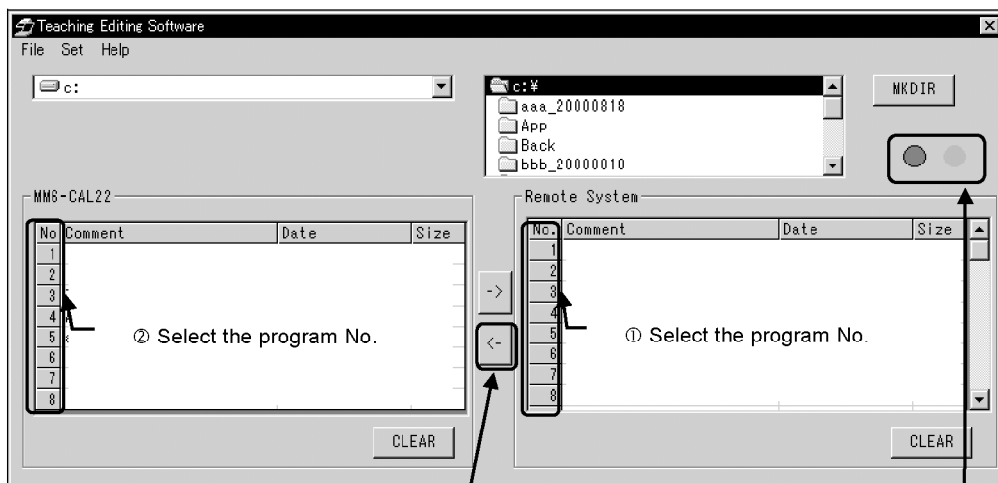

③ Click the <Download> button to start downloading.

### <Communication status check>

The two circles show the status of the connection with the MM6-CAL22. The MM6-CAL22 is not connected if the two circles are not gray.

1. In the [Main] window, select the program number to be downloaded from the "No." column in the [Remote System] teaching program list.
2. Select the program file number to save the downloaded file from the "No." column in the [MM6-CAL22] teaching program list.



<Download> button

3. Click the <Download> button to display the [Download] dialog box.
4. In the [Download] dialog box shown below, select the [MM6-CAL22] program numbers to save the downloaded data.

Click  to select the MM6-CAL22 program number to save the downloaded file.  
 Asterisk "\*" on the top right of a number indicates that there is already a program saved with that number.

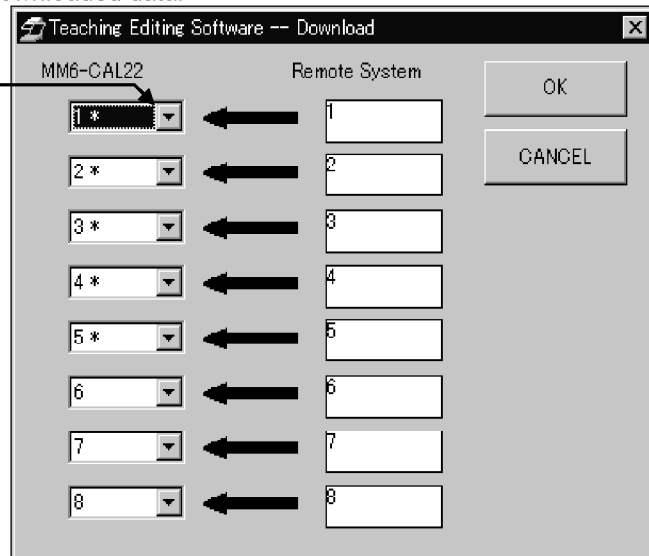

Click the <OK> button to close the dialog box.



When the downloaded program number and destination file number have been selected in the [Remote System] and [MM6-CAL22] teaching program lists, clicking the <Download> button starts downloading without displaying the [Download] dialog box shown above.

When a program is downloaded to the MM6-CAL22 file number with which a program has already been saved, the [Check Overwrite] dialog box appears.

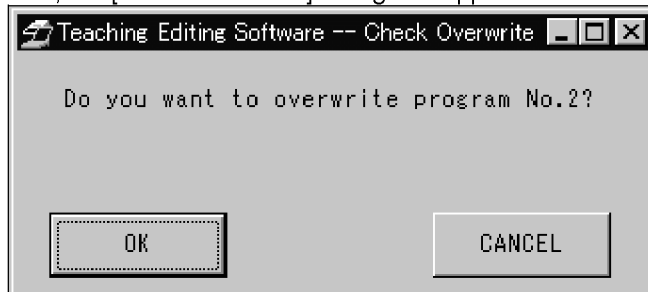

Click the <OK> button to overwrite the previously saved program.



## 9 Exiting from the application

---

See section 1-7.

## 2-3-3 Example of Teaching Program Editing in Offline Mode

### 1 Connecting the dongle.

---

Connect the dongle. See section 1-3 for the connection procedure.

### 2 Starting the application.

---

Start the teaching program editing software. See section 1-6 for the startup procedure.

### 3 Selecting the file

---

Select the program file to be edited. See section 2-3-2-3 for the selection procedure.

### 4 Editing the teaching program

---

In this operation, assume that the program shown in section 2-3-1 is an exiting program and try deletion, copy/paste, modification and insertion of program.

<< Deletion >>

To delete line numbers 8 to 11 in the program shown in section 2-3-1:

1. Select line numbers 8 to 11.



Multiple line numbers of a program can be selected in one of the following three methods.

- Drag line numbers 8 to 11 with the mouse.
- Click line number 8 and, while pressing and holding the <Shift> key, click line number 11.
- Click one line first to select it then, while pressing and holding the <Ctrl> key, click other line numbers.



<Delete> button

2. Select [Delete] from the [Edit] menu or click the <Delete> button in the toolbar.
3. The [Item Deletion Confirmation] dialog box appears before the deletion is executed.



Click the <OK> button to delete the specified range.



For details on the program deletion, see Appendix B-1.

<< Copy/paste >>

To copy line number 13 of the program shown in section 2-3-1 and paste it after the last line in the program:



<Copy> button

● Copying the program

1. Select the line to be copied in the teaching program line list in the [Edit] window.
2. With the line to be copied selected, select [Copy] from the [Edit] menu or click the <Copy> button in the toolbar. The selected program will be copied.

● Pasting the program

1. Select the last line of the program.
2. Select [Paste] from the [Edit] menu or click the <Paste> button in the toolbar. The copied program will be appended to the last line in the teaching program line list in the [Edit] window.



<Paste> button



For details on the copy and paste of programs, see Appendixes B-2 and B-3.



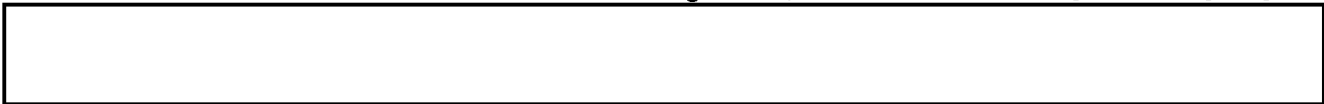

<< Program modification >>

To modify the program pasted in section 2-3-1:

Modification content: Change the internal printer output tem from “A” to “L”.

1. In the teaching program line list in the [Edit] window, double-click the program line to be modified.
2. When the [Output Selection] dialog box appears, showing the current settings. Check all check box in the [Prohibitive Item] group box to set a check mark in it except "L".

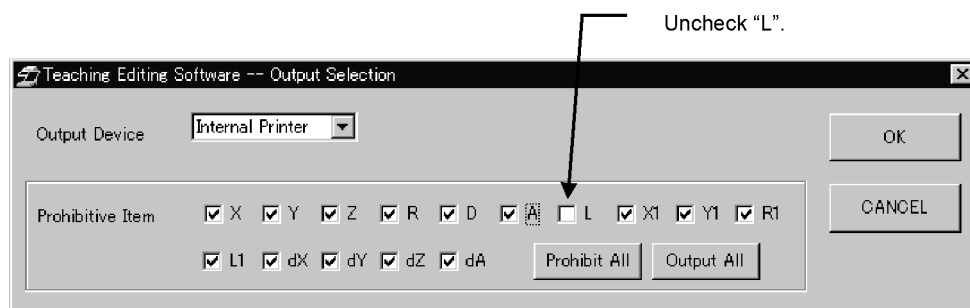

3. After the selection, click the <OK> button to close the [Output Selection] dialog box.

The pasted program line is modified as shown below.

After modification: OUTSL,1,1,2,3,4,5,6,8,9,10,11,12,13,14,15,ENT

Before modification: OUTSL,1,1,2,3,4,5,7,8,9,10,11,12,13,14,15,ENT

**TIP** For details on the program modification, see Appendix B-4.

<< Program insertion >>

To append a newly created program line after the last line in the program shown in section 2-3-1:

The newly created program line is used to input and measure measurement points 29 to 37 shown in Fig. 2-4, and the content is as shown below

Displayed program line: CL10 IP2 IP2 IP2 ENT (Pitch measurement)



<CL10> button



<IP2> button



<DATA> button



<ENT> button

1. Click the <CL10> button. The <CL10> button will remain displayed in the pressed-in position till the completion of measurement.
2. Select the input property: Click the <IP2> button.
3. Click the <DATA> button three times.
4. Click the <ENT> button to end successive measurement.
5. The <CL10> button is displayed in the out position and the program line is added to the last line in the teaching program line list in the [Edit] window.

**TIP**

- The numbers of input points and measurement points can be confirmed in the [Teaching program editing situation] display. See section 4-4-7 for details.
- When a program is added to an existing teaching program, the program is always appended to end of the existing program.

### 5 Exiting from the teaching program (Saving the program)

Exit from the teaching program by saving the edited program.

See section 2-3-2-5 for details.

### 6 Modifying the comment.

Modify the comment entered using the [Edit] window.

See section 2-3-2-6 for details.

### 7 Connecting the MM6-CAL22.

1. To prepare for the connection of the MM6-CAL22, exit from the application and turn the PC off (see section 1-7).
2. Connect the cable. See section 1-4 for the connection procedure.
3. Turn the MM6-CAL22 ON in the maintenance mode, then turn the PC on. See section 1-5 for the procedure for turning the MM6-CAL22 ON.
4. Start up the application (See section 1-6).
5. Set the communication environment. See section 1-8 for the setting procedures.

### 8 Downloading the program file

Download the edited program to the MM6-CAL22.

See section 2-3-2-8 for details.



**9 Exiting from the application**

See section 1-7.

**10 Teaching program after editing**

Teaching Program List	Description
IPCAL,1	Cancels input point calculation.
MULTI,1	Cancels multipoint setting.
OUTSL,1,99,ENT	Selects the output destination. It is the internal printer and the entire measurement results will be printed.
TOLER,1,98,4, +0004.0000,+0000.5000,-0000.5000	Writes a tolerance judgment result in a file. The judgment whether the measurement result of "R" is within the tolerance range defined by standard value of +4.0, upper tolerance limit of +0.5 and lower tolerance limit of -0.5.
TOLER,1,99,6, +150.00.00,+001.00.00,-001.00.00	Write a tolerance judgment result in a file. The judgment whether the measurement result of "A" is within the tolerance range defined by standard value of +15°, upper tolerance limit of +1° and lower tolerance limit of -1°.
AL4 IP1 IP1 IP1	Executes alignment (measurement points 1 to 3 in Fig. 2-4).
OUTSL,1,1,2,3,5,6,7,8,9,10,11,12,13,14,15,ENT	Selects the output destination. It is the internal printer but the output of measurement results of except "R" is inhibited.
CL3 IP3 IP3 IP3	Measures a circle (measurement points 10 to 18 in Fig. 2-4).
OUTSL,1,1,2,3,4,5,7,8,9,10,11,12,13,14,15,ENT	Selects the output destination. It is the internal printer but the output of measurement result of except "A" is inhibited.
CL4 IP1 IP1 IP1 IP1	Measures the angle formed by two lines. The input property is 1-input point (measurement points 19 to 22 in Fig. 2-4).



Teaching Program List	Description
TOLER,2,99	Executes tolerance judgment. The judgment is made based on the contents of file No. 99.
OUTSL,1,1,2,3,4,5,6,7,8,9,10,11,12,14,15,ENT	Selects the output destination. It is the internal printer but the output of measurement result of except "dY" is inhibited.
CL10 IP2 IP2 IP2 ENT	Measures the pitch (measurement points 23 to 28 in Fig. 2-4).
OUTSL,1,1,2,3,4,5,6,8,9,10,11,12,13,14,15,ENT	Selects the output destination. It is the internal printer but the output of measurement result of except "L" is inhibited.
CL10 IP3 IP3 IP3 ENT	Measures the pitch (measurement points 29 to 37 in Fig. 2-4).

**2-3-4 Example of Teaching Program Editing in Online Mode**

**1 Preparations**

1. To prepare for the connection of the MM6-CAL22, turn the PC off.
2. Connect the dongle. See section 1-3 for the connection procedure.
3. Connect the cable. See section 1-4 for the connection procedure.
4. Turn the MM6-CAL22 ON in the maintenance mode, then turn the PC on. See section 1-5 for the procedure for turning the MM6-CAL22 ON.
5. Set the communication environment. See section 1-8 for the setting procedures.

**2 Starting the application.**

Start the teaching program editing software. See section 1-6 for the startup procedure.

**3 Uploading the program file**

**Uploading:**

In this manual, uploading always refers to transferring a teaching program saved in the MM6-CAL22 into the [Remote System] teaching program list of the MM6-CAL22.



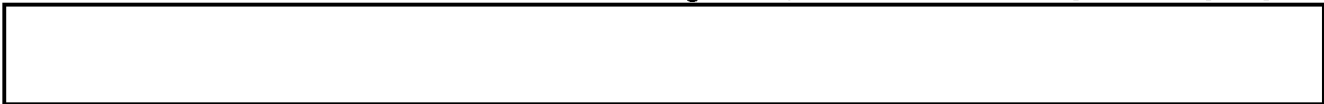

Uploading makes it possible to transfer a program file from the MM6-CAL22 to the remote system (PC).

**NOTE** Make sure to connect the MM6-CAL22 to the PC before proceeding to uploading.

② Select the upload destination directory.

① Select the upload destination drive.

③ Select the program number to be uploaded

④ Select the program number to save the uploaded data.

⑤ Click the <Upload> button to start uploading.

**<Communication status check>**

The two circles show the status of the connection with the MM6-CAL22.  
The MM6-CAL22 is not connected if the two circles are not gray.

1. In the [Main] window, select the drive name where the uploaded program is to be saved.
2. Select the directory name where the uploaded program is to be saved. (To create a new directory, see 3-3-1-3.)
3. In the [MM6-CAL22] teaching program list, select the program number to be uploaded.
4. In the [Remote System] teaching program list, select the program number to save the uploaded data.
5. Click the <Upload> button to display the [Upload] dialog box.
6. In the [Upload] dialog box shown below, select the [Remote System] program number(s) to save the uploaded data.





Click  to select the remote system program number to save the downloaded file.

Asterisk "\*" on the top right of a number indicates that there is already a program saved with that number.

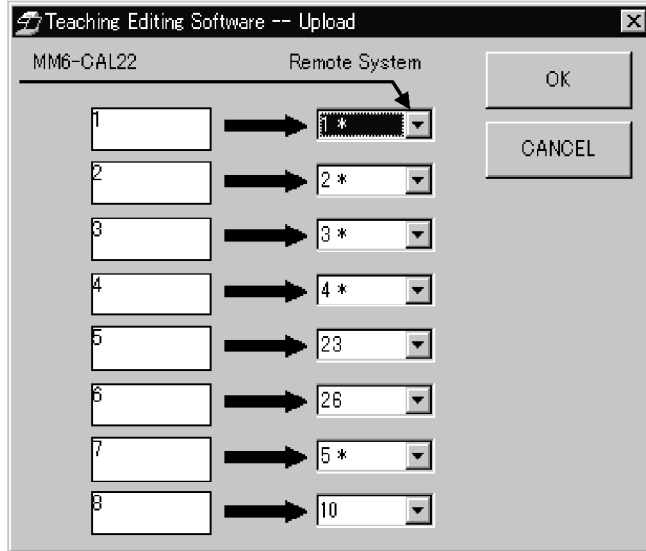

When the uploaded program number and destination file number have been selected in the [MM6-CAL22] and [Remote System] teaching program lists, clicking the <Upload> button starts uploading without displaying the [Upload] dialog box shown above.

Click the <OK> button to close the dialog box.

When a program in MM6-CAL22 is uploaded to the remote system file number with which a program has already been saved, the [Check Overwrite] dialog box appears.

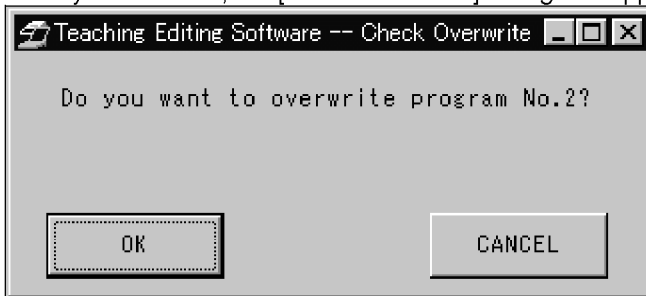

Click the <OK> button to overwrite the previously saved program.

#### 4 Selecting the file

Select the program file saving data uploaded as described in section 2-3-4-3. See section 2-3-2-3 for the selection procedure.



### **5 Editing the teaching program**

---

In this operation, assume that the program shown in section 2-3-1 is an existing program and try deletion, copy/paste, modification and insertion of program.

See section 2-3-3-4 for details of the editing operation.

### **6 Closing the [Edit] window (Saving the program)**

---

Complete the teaching program editing by saving the edited program.

See section 2-3-2-5 for details.

### **7 Modifying the comment.**

---

Modify the comment entered using the [Edit] window.

See section 2-3-2-6 for details.

### **8 Downloading the program**

---

Download the edited program in the MM6-CAL22.

See section 2-3-2-8 for detailed procedure of downloading.

### **9 Exiting from the software**

---

See section 1-7.

### **10 After modification of the teaching program**

---

See section 2-3-3-10.





# 3 [MAIN] Window

## 3-1 Basic Screen Display Items

**Menu bar**  
(Section 3-2)

**Drive select drop-down list**  
Specify the drive name of the remote system. (Section 3-3-1-1)

**Directory select box**  
Specify the directory name in the remote system. (Section 3-3-1-2)

**Communication status check**  
(Section 3-3-6)

**<MKDIR> button**  
Click to create a new folder. (Section 3-3-1-3)

**[MM6-CAL22] teaching program list**  
(Section 3-3-2)

No.	Comment	Date	Size
1		00.08.22 14.44	7
2	lll	00.08.22 18.34	13
3	TEST03	00.08.18 16.00	8
4	AL9	00.08.18 17.53	137
5	aaaa	00.08.04 13.54	9
6			
7			
8			

**[Remote System] teaching program list**  
Double-click a file number in the "No." column to open the program in the selected file number. (Section 3-3-3)

No.	Comment	Date	Size
1	aaaa	00.08.04 13.54	9
2	TEST03	00.08.18 17.32	8
3	TEST03	00.08.18 16.00	8
4	AL9	00.08.18 17.53	137
5	A	00.08.22 15.10	13
6		00.08.22 14.32	8969
7		00.08.22 15.23	192
8		00.08.22 15.24	37

**<CLEAR> button**  
Click to clear the selected programs in the [MM6-CAL22] teaching program list. (Section 3-3-4)

**Teaching program <Upload>/<Download> buttons**  
(Section 3-3-5)

**<CLEAR> button**  
Click to clear the selected programs in the [Remote System] teaching program list. (Section 3-3-4)

**TIP** According to the user setting, a part of window may be disappeared when using this software in 800X600 desk-top size. In case, position the window to be visible.



### 3-2 Menu Bar

#### 3-2-1 File Menu

##### 1 Backup

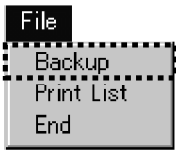

This item is used to back up all of the teaching programs saved in the MM6-CAL22 in a designated directory. The directory can be designated in the [Set Backup Directory] dialog box. See section 3-2-2-2 for the setting procedure.

The teaching programs are copied in the designated directory. If teaching programs have already been saved in the designated directory, the [Check Overwrite] dialog box appears.

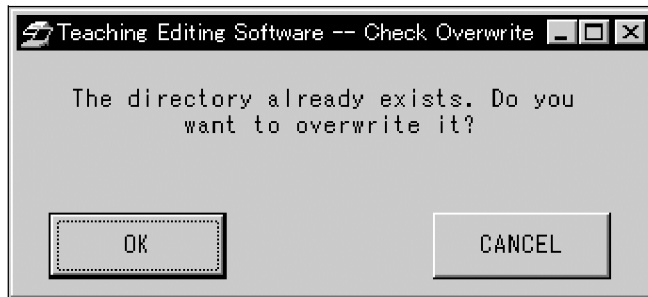

Click the <OK> button to overwrite the existing programs. If you do not want to overwrite them, click the <CANCEL> button.

The backed-up programs are named automatically as shown below.

Backed-up file name: CALTEACH\_1.tch

Teaching program No. (1 to 8) is inserted.

##### 2 Print List

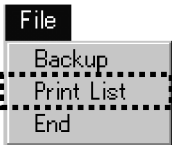

This item is used to print the list of the teaching programs saved in the MM6-CAL22. The printing format is similar to the format used in printing by the MM6-CAL22.



### 3 Exit

Exits from the teaching program editing software. The [End] dialog box appears.

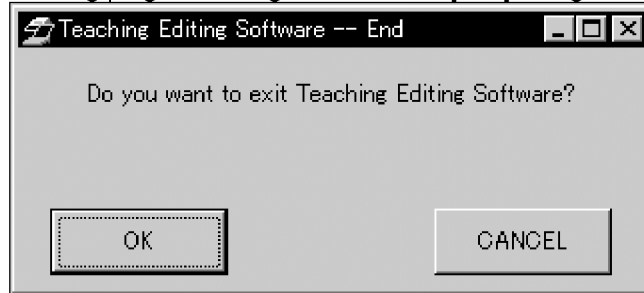
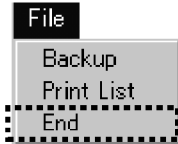

Click the <OK> button to exit from the teaching program editing software. If you do not want to exit from it, click the <CANCEL> button.

## 3-2-2 Settings Menu

### 1 Set Communication Environment



This item is used to set the environment for communication with the MM6-CAL22. The [Connect] dialog box appears for actual settings. The displayed dialog box is variable depending on whether or not the MM6-CAL22 is connected to the PC.

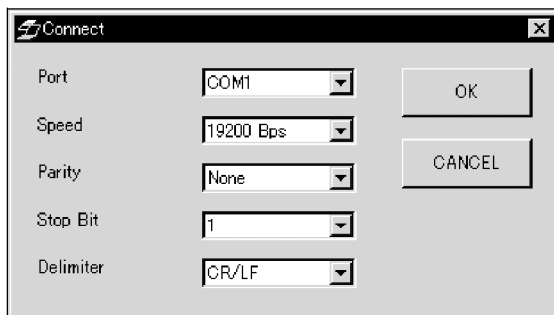

Dialog box when the MM6-CAL22 is connected

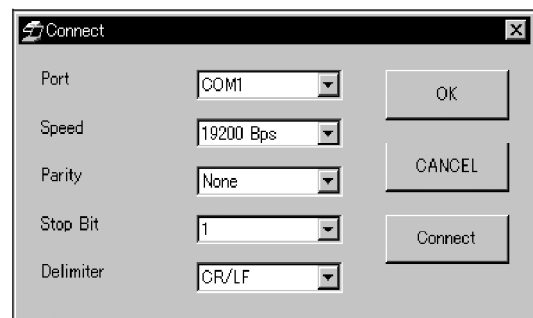

Dialog box when the MM6-CAL22 is not connected

The initial setup of the communication environment is as follows.

Port: COM1, Speed: 19,200 Bps, Parity: None, Stop bit: 1, Delimiter : CR/LF.



- Port : Set the serial port on the PC by selecting either COM1 or COM2.
- Speed : Set the serial communication rate by selecting one of 19200 Bps, 9600 Bps, 4800 Bps and 2400 Bps.
- Parity : Set the parity check in serial communication by selecting one of None, Odd and Even.
- Stop bit : Set the stop bit in serial communication by selecting either 1 or 2.
- Delimiter : Set the delimiter in serial communication by selecting either CR/LF or CR.
- <OK> button : Click to save the set communication environment and close the [Connect] dialog box.
- <CANCEL> button : Click to close the [Connect] dialog box without saving the set communication environment.
- <Connect> button : This button is displayed only when the MM6-CAL22 is not connected. Click this button to start connection. An error message would be displayed if connection failed.

## 2 Set backup directory

**Set**

- Set Communication Environment
- Set Backup Directory**

This item is used to designate the backup directory where the backup file of all the teaching programs saved in the MM6-CAL22 by opening the [Set Backup Directory] dialog box.

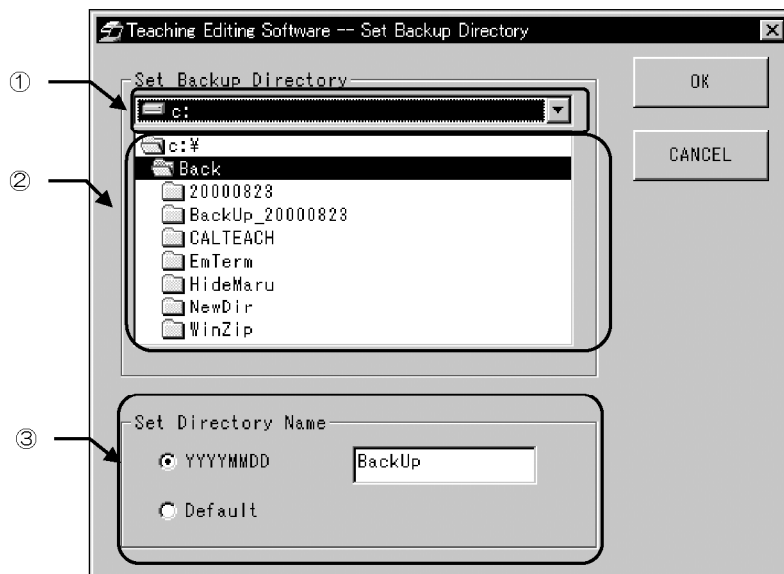

1. Designate the drive of the backup directory by clicking  of ①.
2. Designate the directory by selecting its name from ②.
3. Set the directory name by selecting "YYYYMMDD" or "Default" in ③.

<When "YYYYMMDD" is selected>

The backup execution date (year, month, day) is set as the directory name. Desired characters can be placed before the date characters by entering the desired characters in the text box on the right. In this case, an underline ( \_ ) is inserted between the entered characters and date characters.

Example: Directory name when no character is entered: 20000510

Directory name when "BackUp" is entered in the text box:

BackUp\_20000510

<When "Default" is selected>

The characters entered in the text box is set as the directory name.

Example: Directory name when "BackUp" is entered in the text box: BackUp

4. Click the <OK> button or <CANCEL> button.

Click the <OK> button to save the settings and close the [Set Backup Directory] dialog box.

Click the <CANCEL> button to close the [Set Backup Directory] dialog box without saving the changed settings.

### 3-2-3 Help Menu

#### 1 Version



This item is used to show the version of the teaching program editing software and that of the MM6-CAL22 in the [Version] dialog box. (The version of the MM6-CAL22 is not shown when it is not connected.)



Click the <OK> button to close the [Version] dialog box.

### 3-3 [Main] Window

#### 3-3-1 Remote System Drive and Directory Selection

To show the teaching programs saved in the remote system (PC) in the [Remote System] teaching program list, it is required to designate the drive and directory of the remote system. It is also possible to create a new directory under the designated directory.

##### 1 Selecting the drive name

Select the drive name of the remote system.

Click the <▼> button of the drive selection drop-down list and select the drive name from the drop-down list. The directories in the selected drive are displayed.

##### 2 Selecting the directory

Select the directory in the remote system to be used.

The drive name selected in section 3-3-1-1 and the directories in the drive are shown in the directory selection box.



A directory can store up to 128 files.

##### 3 Creating a new folder

A new directory can be created under the directory selected in the [directory select] box.

Click the <MKDIR> button to display the [Create Directory] dialog box.

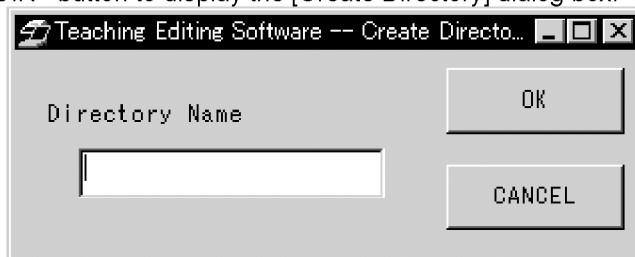

Enter the name of the directory to be created newly, then click the <OK> button. If the <CANCEL> button is clicked, the dialog box closes without creating a new directory.

**NOTE**

If the entered directory name is already used with another directory, an error message will be displayed. In this case, click the <OK> button to reset the error message then click the <MKDIR> button again and enter a different directory name.

**3-3-2 [MM6-CAL22] Teaching Program List****NOTE**

This function can be selected only when the MM6-CAL22 is connected.

This list shows the teaching programs saved in the MM6-CAL22.

To select a program, select its number in the "No" column. One or more programs can be selected together.

Click one of these numbers to select a program.

No	Comment	Date	Size
1		00.08.22 14.44	7
2	llll	00.08.22 13.34	13
3	TEST03	00.08.18 16.00	8
4	AL9	00.08.18 17.53	137
5	aaaa	00.08.04 13.54	9
6			
7			
8			

No. : Indicates the teaching program number (1 to 8). If a line of a program number contains no data in the "Comment", "Date" and "Size" columns, there is no program saved in the program number.

Comment: Shows the comment entered for the teaching program.

Date : Shows the date of the teaching program creation and saving in the MM6-CAL22.

Size : Shows the capacity of the teaching program (unit: Bytes).



Multiple program numbers can be selected in one of the following three methods.

- When selecting serial program numbers (Example: No. 1 through No. 3), drag the selected program numbers with the mouse.
- When selecting serial program numbers (Example: No. 1 through No. 3), click the starting line number and, while pressing and holding the <Shift> key, click the ending line number.
- Click one program number first to select it then, while pressing and holding the <Ctrl> key, click other program numbers.

### 3-3-3 [Remote System] Teaching Program List

This list shows the teaching programs saved in the designated drive and directory.

To select a program, select its number in the “No” column. One or more programs can be selected together.

When the selected program number is double-clicked, the [Edit] program for the selected number appears. If a program number without any program saved is double-clicked, a program can be created newly in the selected program number. See Chapter 4 for details on the [Edit] window.

Click one of these numbers to select a program. Double-click one of the numbers to display the [Edit] window (chapter 4).

No.	Comment	Date	Size
1	aaaa	00.08.04 13.54	9
2	TEST03	00.08.18 17.32	8
3	TEST03	00.08.18 18.00	8
4	AL9	00.08.18 17.53	137
5	A	00.08.22 15.10	13
6		00.08.22 14.32	8969
7		00.08.22 15.23	192
8		00.08.22 15.24	37

CLEAR

**No.** : Indicates the teaching program number (1 to 128). If a line of a program number contains no data in the “Comment”, “Date” and “Size” columns, there is no program saved in the program number.

**Comment** : Shows the comment entered for the teaching program. Comment can be entered in an existing program by clicking the “Comment” column of the program number you want to enter comment. The comment can be entered using up to 24 alphanumeric and Japanese *katakana* characters.

**Date** : Shows the date of the teaching program creation and saving in the remote system.

**Size** : Shows the capacity of the teaching program (unit: Bytes).



**TIP**

Multiple program numbers can be selected in one of the following three methods.

- When selecting serial program numbers (Example: No. 1 through No. 3), drag the selected program numbers with the mouse.
- When selecting serial program numbers (Example: No. 1 through No. 3), click the starting line number and, while pressing and holding the <Shift key>, click the ending line number.
- Click one program number first to select it then, while pressing and holding the <Ctrl> key, click other program numbers.

**3-3-4 CLEAR Buttons**

The CLEAR buttons clears the teaching program saved in the MM6-CAL22 or remote system. To clear a program(s) in the [MM6-CAL22] teaching program list, select the program(s) in the list and click the <CLEAR> button on the below right. To clear a program(s) in the [Remote System] teaching program list, select the program(s) in the list and click the <CLEAR> button on the below right.

**TIP**

Multiple program numbers can be selected and cleared in one of the following three methods.

- When selecting and clearing serial program numbers (Example: No. 1 through No. 3), drag the selected program numbers with the mouse.
- When selecting and clearing serial program numbers (Example: No. 1 through No. 3), click the starting line number and, while pressing and holding the <Shift key>, click the ending line number.
- Click one program number first to select it then, while pressing and holding the <Ctrl> key, click other program numbers.

When the program(s) to be cleared is selected and the <CLEAR> button is clicked, the [Deletion Check] dialog box appears. The displayed dialog box is variable depending on the number of selected program(s).

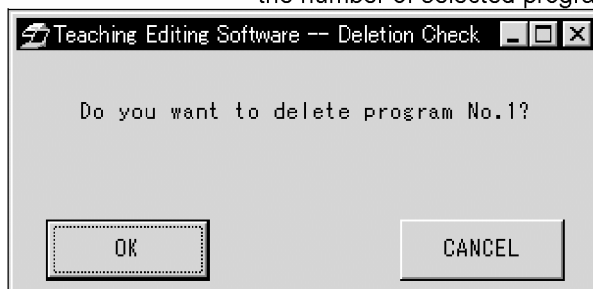

Dialog box when clearing a single program

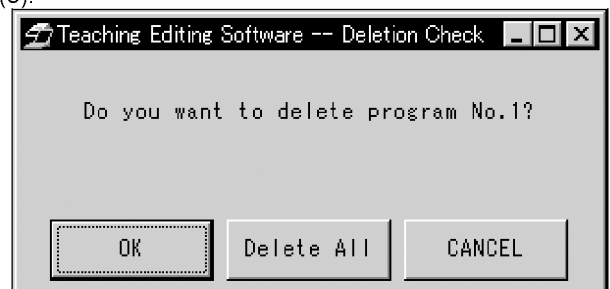

Dialog box when clearing multiple programs



To clear a single program:

Click the <OK> button to clear the selected program.

Click the <CANCEL> button to cancel the program clearing.

To clear multiple programs:

The dialog box shows one of the program numbers to be cleared.

Click the <OK> button to clear only the program number being displayed.

Click the <Delete All> button to clear all of the selected programs at once.

Click the <CANCEL> button to cancel the clear of the program being displayed.

### 3-3-5 <Upload>/<Download> Buttons



**This function is available only when the MM6-CAL22 is connected.**

#### 1 Upload button

This button is used to upload the program selected in the [MM6-CAL22] teaching program list into the [Remote System] teaching program list. (Uploading is not possible during communication with the MM6-CAL22 or when it is not connected.) The button can also be used to upload multiple programs together.

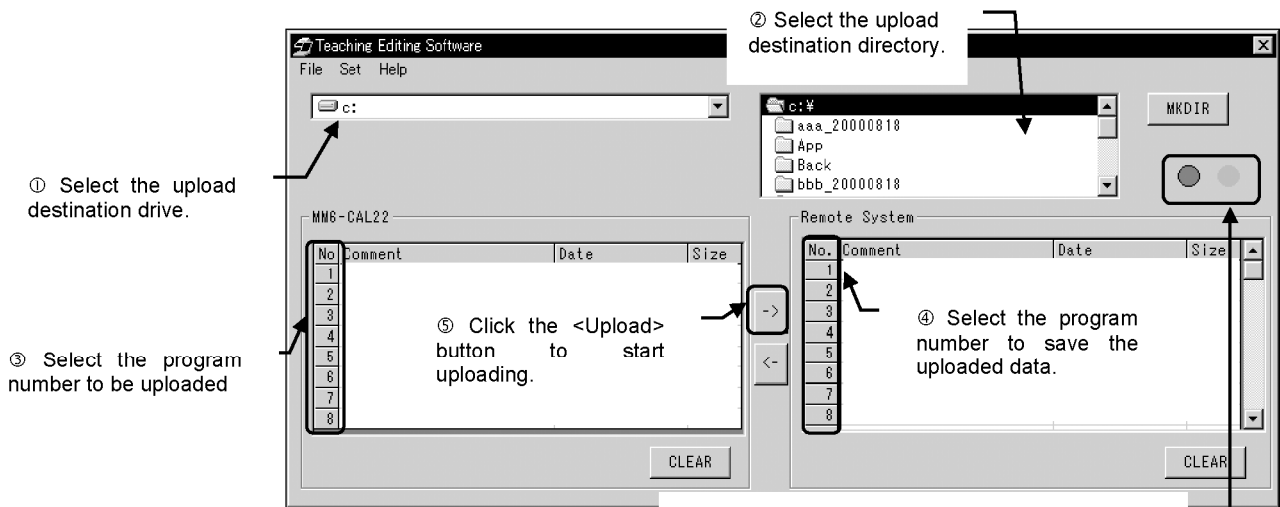

#### <Communication status check>

The two circles show the status of the connection with the MM6-CAL22. The MM6-CAL22 is not connected if the two circles are not gray.

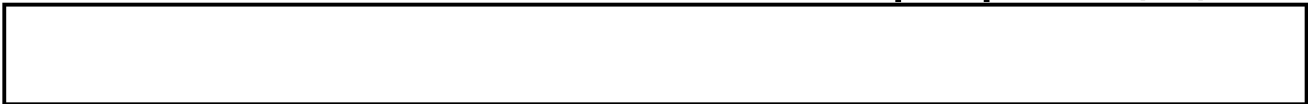

<< Uploading procedure >>

1. Select the upload destination drive name where the uploaded program(s) is to be saved.
2. Select the upload destination directory name. (To create a new directory, see 3-3-1-3.)
3. In the [MM6-CAL22] teaching program list, select the program number(s) to be uploaded (up to 8 program numbers can be selected together).
4. In the [Remote System] teaching program list, select the program number to save the uploaded data (up to 8 program numbers can be selected together).



Multiple program numbers can be selected in one of the following three methods.

- When selecting serial program numbers (Example: No. 1 through No. 3), drag the selected program numbers with the mouse.
- When selecting serial program numbers (Example: No. 1 through No. 3), click the starting line number and, while pressing and holding the <Shift key>, click the ending line number.
- Click one program number first to select it then, while pressing and holding the <Ctrl> key, click other program numbers.



<Upload> button

5. Click the <Upload> button to display the [Upload] dialog box.
6. In the [Upload] dialog box shown below, select the [Remote System] program number(s) to save the uploaded data.

Click  to select the remote system program number to save the uploaded file.

Asterisk "\*" on the top right of a number indicates that there is already a program saved with that number.

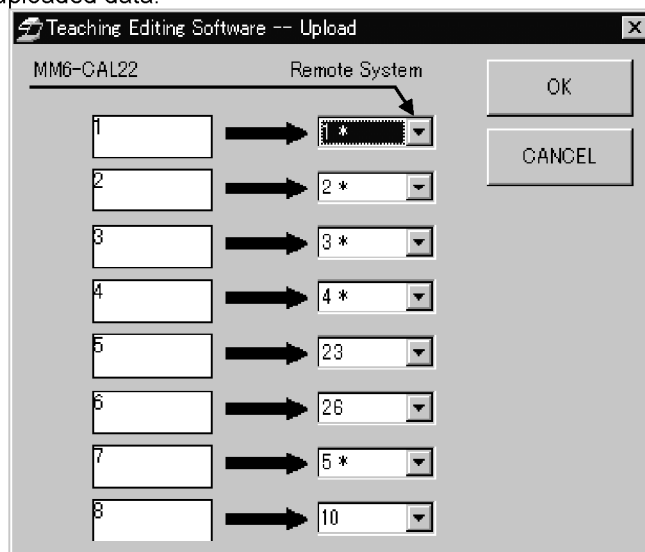

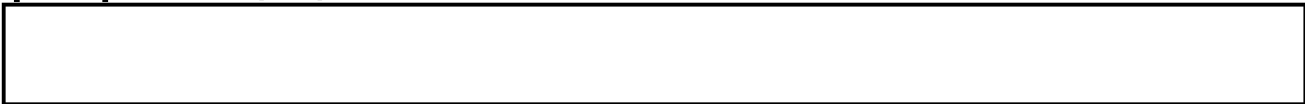

When the uploaded program number and destination file number have been selected in the [MM6-CAL22] and [Remote System] teaching program lists, clicking the <Upload> button starts uploading without displaying the [Upload] dialog box shown above.

7. Click the <OK> button to close the dialog box.

When a program in MM6-CAL22 is uploaded to the remote system file number with which a program has already been saved, the [Check Overwrite] dialog box appears.

The displayed dialog box is variable depending on the number of selected program(s).

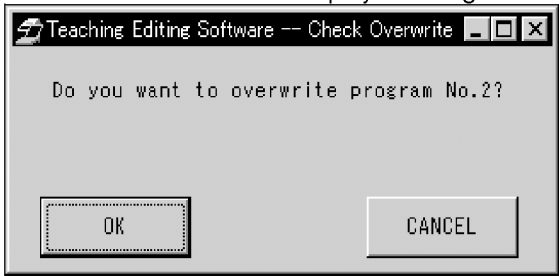

Dialog box when overwriting a single program

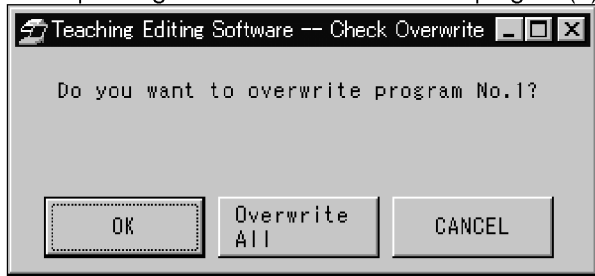

Dialog box when overwriting multiple programs

To overwrite a single program:

Click the <OK> button to overwrite the existing program.

Click the <CANCEL> button to cancel the program overwriting.

To overwrite multiple programs:

Click the <OK> button to overwrite only the program being displayed.

Click the <Overwrite All> button to overwrite all of the existing programs at once.

Click the <CANCEL> button to cancel the overwrite of the program being displayed.



## 2 <Download> button

This button is used to download the program selected in the [Remote System] teaching program list into the [MM6-CAL22] teaching program list. (Downloading is not possible during communication with the MM6-CAL22 or when it is not connected.) The button can also be used to download multiple programs together.

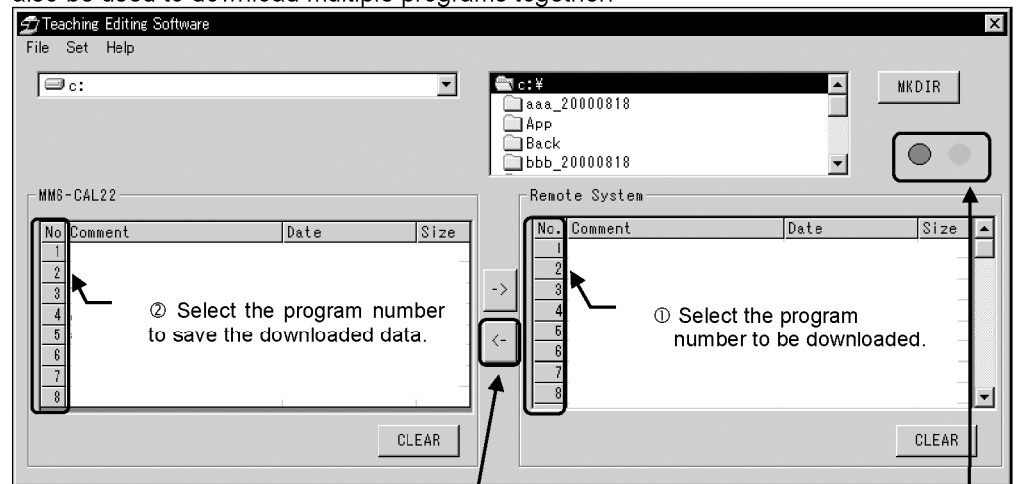

③ Click the <Download> button to start downloading.

### <Communication status check>

The two circles show the status of the connection with the MM6-CAL22. The MM6-CAL22 is not connected if the two circles are not gray.

### << Downloading procedure >>

1. In the [Remote System] teaching program list, select the program number(s) to be downloaded (up to 8 program numbers can be selected together).
2. In the [MM6-CAL22] teaching program list, select the program number(s) to save the uploaded data (up to 8 program numbers can be selected together).

### TIP

Multiple program numbers can be selected in one of the following three methods.

- When selecting serial program numbers (Example: No. 1 through No. 3), drag the selected program numbers with the mouse.
- When selecting serial program numbers (Example: No. 1 through No. 3), click the starting line number and, while pressing and holding the <Shift> key, click the ending line number.
- Click one program number first to select it then, while pressing and holding the <Ctrl> key, click other program numbers.



<Download> button

1. Click the <Download> button to display the [Download] dialog box.
2. In the [Download] dialog box shown below, select the [MM6-CAL22] program number(s) to save the downloaded data.

Click  to select the remote system program number to save the downloaded file. Asterisk "\*" on the top right of a number indicates that there is already a program saved with that number.

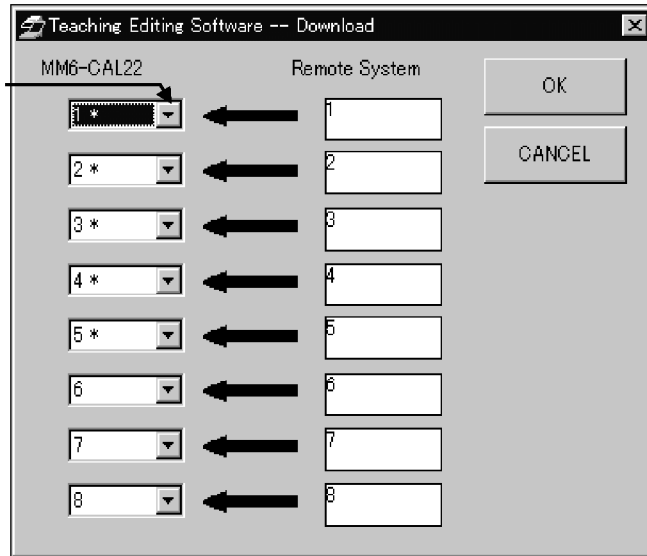

Click the <OK> button to close the dialog box.



When the downloaded program number and destination file number have been selected in the [Remote System] and [MM6-CAL22] teaching program lists, clicking the <Download> button starts downloading without displaying the [Download] dialog box shown above.

When a program in the remote system is downloaded to the MM6-CAL22 file number with which a program has already been saved, the [Check Overwrite] dialog box appears.

The displayed dialog box is variable depending on the number of selected program(s).

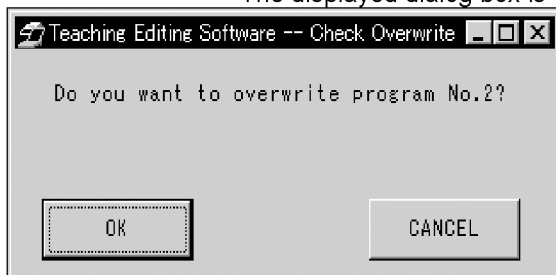

Dialog box when overwriting a single program

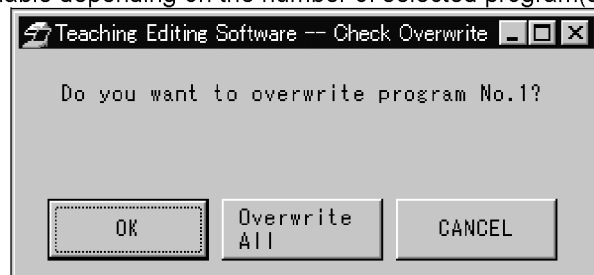

Dialog box when overwriting multiple programs



To overwrite a single program:

Click the <OK> button to overwrite the existing program.

Click the <CANCEL> button to cancel the program overwriting.

To overwrite multiple programs:

Click the <OK> button to overwrite only the program being displayed.

Click the <Overwrite All> button to overwrite all of the existing programs at once.

Click the <CANCEL> button to cancel the overwrite of the program being displayed.

### **3-3-6 Communication Status Check**

The two circles show the current communication status.

When the circles are green and gray: Communication ready.

When the circles are gray and red: Communicating.

When both circles are gray: MM6-CAL22 not connected.





# 4 [EDIT] Window

## 4-1 Basic Screen Display Items

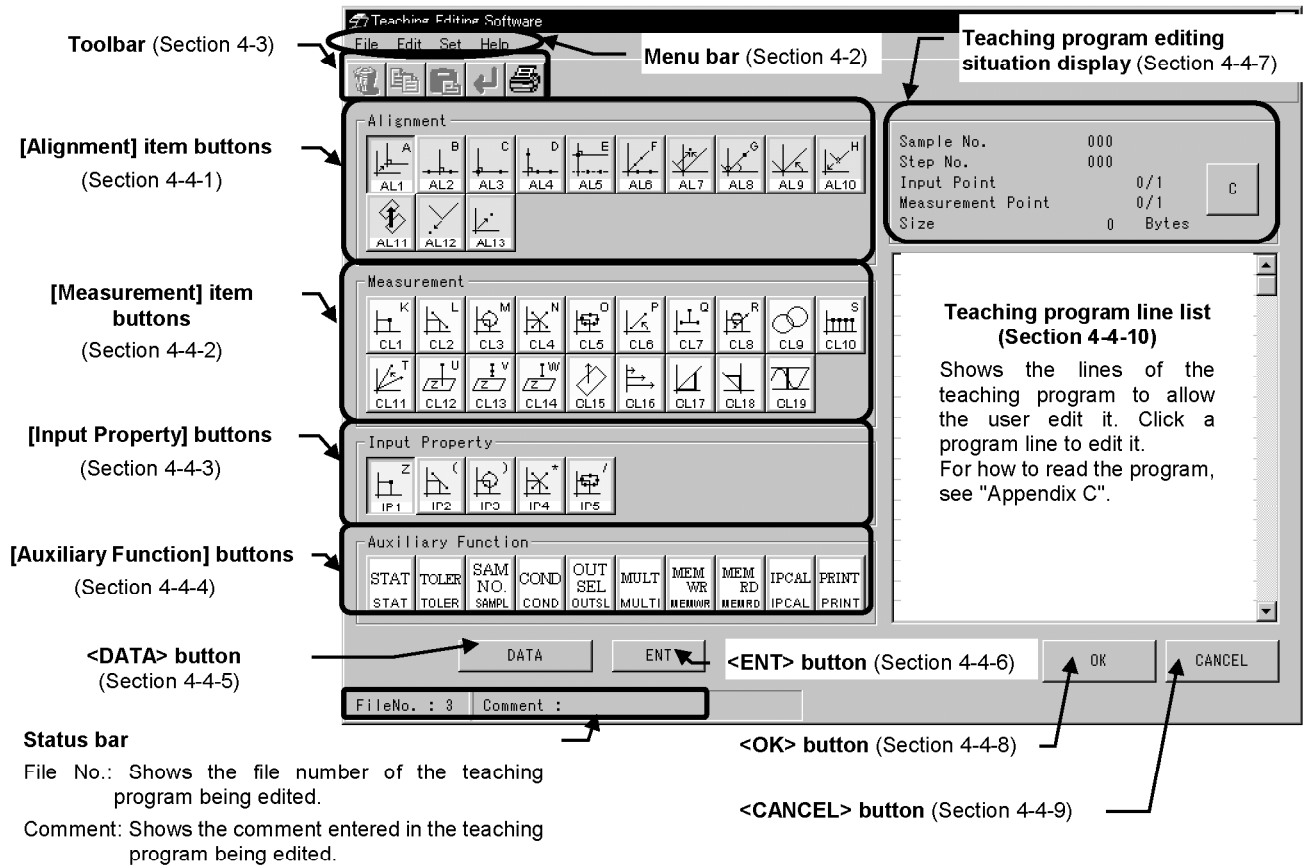

According to the user setting, a part of window may be disappeared when using this software in 800X600 desk-top size. In case, position the window to be visible.

### Main Functions of the [Edit] Window

The [Edit] makes the user possible to create and edit teaching programs using the following functions.

- Teaching program display  
The teaching program line list shows the lines of a teaching program.
- Print, Delete, Copy, Paste, Undo  
The teaching program lines shown in the teaching program line list can be printed (section 4-2-1-1), deleted (section 4-2-2-1), copied (section 4-2-2-2) and pasted (section 4-2-2-3), and any of these operations can be undone (section 4-2-2-4).
- Modification of program, program appending to the existing program  
The teaching program lines shown in the teaching program line list can be modified (section 4-2-2-5) and the newly created program lines can be appended to the existing program. Note that new program lines are always appended after the last line in the existing program.



## 4-2 Menu Bar

### 4-2-1 File Menu

#### 1 Print List



This item is used to print the list of the teaching program being edited in the [Edit] window.

### 4-2-2 Edit Menu

#### 1 Delete

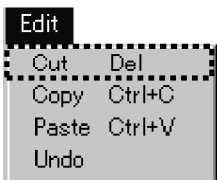

This item is used to delete the selected range of lines in the teaching program line list. First specify the range of program lines to be deleted. For the detailed specification procedure, see Appendix B-1.

If the specified range is incorrect, an error message will be displayed. In this case, reset the error and restart the deleted range specification from the beginning.

The [Item Deletion Confirmation] dialog box appears before the specified range is deleted actually.



Click the <OK> button to delete the specified range.

Click the <CANCEL> button to cancel deletion of the specified range.

**TIP** Delete of selected lines is also possible by pressing <Delete>.

#### 2 Copy

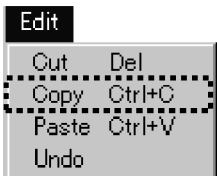

This item is used to copy the selected range of lines in the teaching program line list. First specify the range of program lines to be copied. For the detailed specification procedure, see Appendix B-2.

If the specified range is incorrect, an error message will be displayed. In this case, reset the error and restart the copied range specification from the beginning.

**TIP** Copy of selected lines is also possible by pressing <Ctrl> + <C>.

### 3 Paste

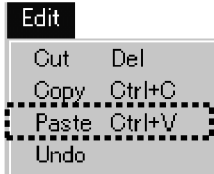

This item is used to paste the copied range of lines in the desired lines in the teaching program line list.

First select the paste destination position. For details on the pasted position selection, see Appendix B-3.

If the copied range of lines is pasted in a wrong position, an error message will be displayed. In this case, reset the error and restart pasting again.



Paste of copied lines is also possible by pressing <Ctrl> + <V>.

### 4 Undo

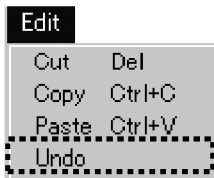

This item is used when it is required to retry the operation performed immediately before (Delete, Copy, Paste or Modification)

Undo cannot delete lines in the teaching program line list. These lines can be deleted only by using the Cut function.

Undo cannot be selected during creation of a teaching program.

### 5 Modification



The Modification function is not provided in the File menu.

Modification should be performed by observing the following rule. For an example of modification, see Appendix B-4.

- To modify a line in a teaching program, double-click the desired line in the teaching program line list
- The functions that can be modified include only the AL7, AL9, AL13, CL17, CL18 and auxiliary functions. If it is required to modify other item than them, delete it (Appendix B-1) and insert a new item.
- Note that new program lines are always appended after the last line in the existing program.

## 4-2-3 Set Menu

### 1 Unit of Measurement

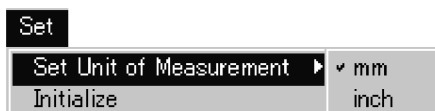

This item is used to set the unit of measurement to "mm" or "inch".



## 2 Initial Setup

Perform the initial setup before newly creating or editing a teaching program. If input point calculation or multipoint measurement has been used before the program listed in the teaching program line list, the teaching program will be created or edited based on the previously made setting, which may lead to inconsistency in the program. To prevent inconsistency in the input point calculation and multipoint measurement, be sure to perform the initial setup.

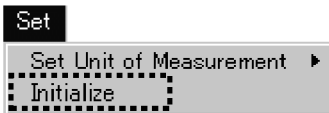

Perform initial setup of the teaching program editing conditions. Open the [Initialization] dialog box and set the following items.

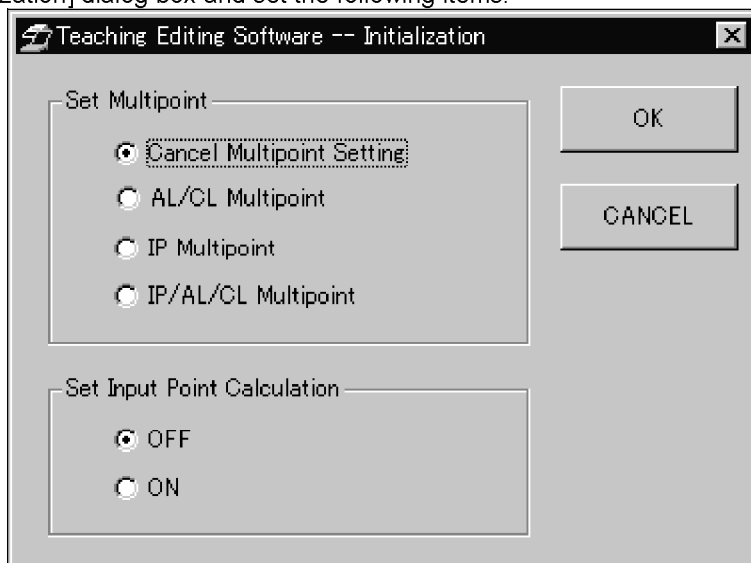

[Set Multipoint] group box

This is used for initial setup of the multipoint measurement function. If the multipoint function has been used before the currently selected program is displayed in the teaching program line list and the use of multipoint function is expected with the current program, perform initial setting here to prevent inconsistency in programs.

- Cancel Multipoint Setting : Multipoint function will not be used.
- AL/CL Multipoint : Multipoint function is set to the AL (alignment items) and CL (measurement items).
- IP Multipoint : Multipoint function is set to the IP (input property).
- IP/AL/CL Multipoint : Multipoint function is set to the IP (input property), AL (alignment items) and CL (measurement items)



[Set Input Point Calculation] group box

This is used for initial setup of the input point calculation function. If the input point calculation function has been used before the currently selected program is displayed in the teaching program line list and the use of input point calculation function is expected with the current program, perform initial setting here to prevent inconsistency in programs.

- OFF : Input point calculation will not be used.
- ON : Input point calculation will be used.

## 4-2-4 Help Menu

### 1 Version



This item is used to show the version of the teaching program editing software and that of the MM6-CAL22 in the [Version] dialog box. (The version of the MM6-CAL22 is not shown when it is not connected.)

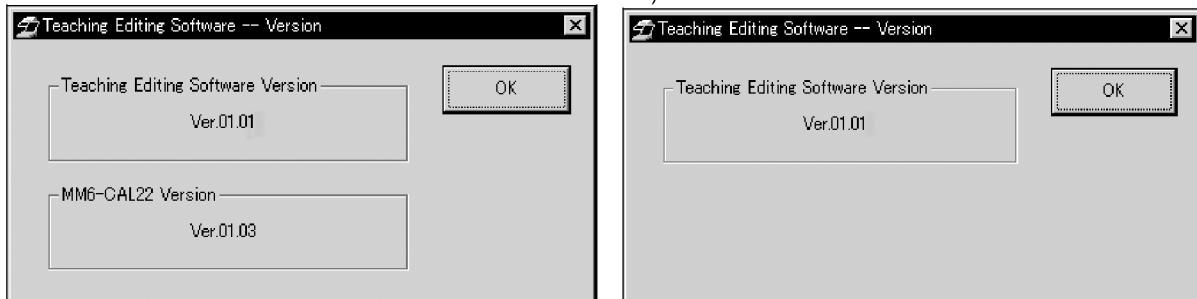

Click the <OK> button to close the [Version] dialog box.



## 4-3 Toolbar

Before applying a function is the toolbar, it is required to specify the range to which the function is applied in the teaching program line list.

### 4-3-1 Delete



<Delete> button

This button deletes the selected range of lines in the teaching program line list. First specify the range of program lines be deleted. For the detailed specification procedure, see Appendix B-1.

The [Item Deletion Confirmation] dialog box appears before the specified range is deleted actually.

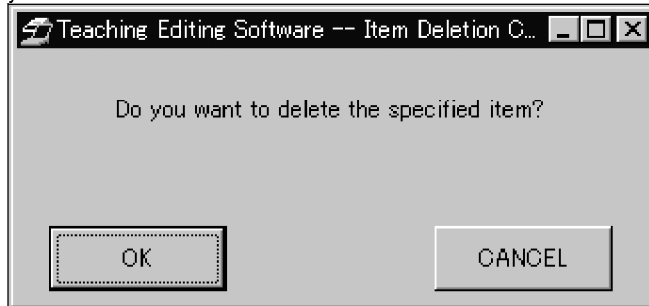

Click the <OK> button to delete the specified range.

Click the <CANCEL> button to cancel deletion of the specified range.

### 4-3-2 Copy



<Copy> button

This button copies the selected range of lines in the teaching program line list. First specify the range of program lines to be copied. For the detailed specification procedure, see Appendix B-2.

### 4-3-3 Paste



<Paste> button

This button pastes the copied range of lines in the desired lines in the teaching program line list.

First select the paste destination position. For details on the pasted position selection, see Appendix B-3.



#### 4-3-4 Undo



<Undo> button

This button is used when it is required to retry the operation performed immediately before (Delete, Copy, Paste or Modification)

Undo cannot delete lines in the teaching program line list. These lines can be deleted only by using the Delete function.

Undo cannot be selected during creation of a teaching program.

#### 4-3-5 Print List



< Print List > button

This button prints the list of the teaching program being edited in the [Edit] window.

## 4-4 Edit Window Description

### 4-4-1 [Alignment] Item Buttons

Select the button to register in the teaching program by clicking one of the [alignment] item buttons.

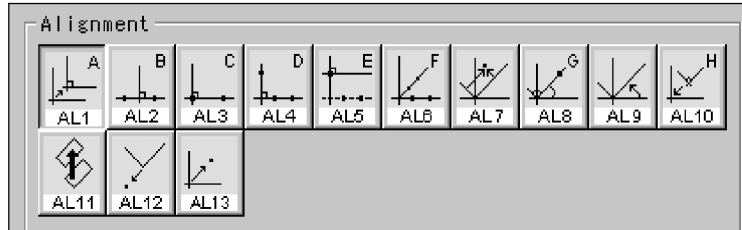

When an [alignment] item button is selected and the input and measurement points are entered, other buttons are defeated and cannot be selected (except for the <IPCAL> button). The input and measurement points can be confirmed in the teaching program editing situation display (below).

When these values are not "0", other buttons (except for the <IPCAL> button) cannot be selected. To select other buttons, click the <C> button to clear the numbers of the input and measurement points to "0".

Sample No. 000

Step No. 000

Input Point (20) 0/1

Measurement Point 0/1

Size 1000 Bytes

C

Sample No. 000

Step No. 000

Input Point 0/2

Measurement Point 0/1

Size 1000 Bytes

C

**Display with multipoint measurement**

**Display with ordinary measurement**

When an [alignment] item button is selected, it remains displayed in the pressed-in position until the setting of the item completes. When the settings completes, the result is shown in the teaching program line list and the alignment item button returns to the out position. Instead, the <CL1> (<Measurement> item) button and <IP1> (<Input Property>) button are automatically displayed in the pressed-in positions.

**TIP** For the function of each of the [alignment] item buttons, see Appendix A-1 or the instruction manual entitled "User's Manual MM6-CAL22".

The setting of the [alignment] item buttons is variable depending on the buttons.



## 1 <AL1> to <AL6>, <AL8>, <AL10> to <AL12> buttons

Click one of these [alignment] item buttons, then click one of the [Input Property] buttons and select the measurement points. (The measurement point selection is not required with the <AL10> and <AL12> buttons.)

## 2 <AL7> button



<AL7> button

1. Click the <AL7> button.
2. Click one of the [Input Property] buttons to select the measurement point(s).
3. Click the <DATA> button until getting the input points.
4. The [AL7] dialog box appears when the measurement point(s) is selected.

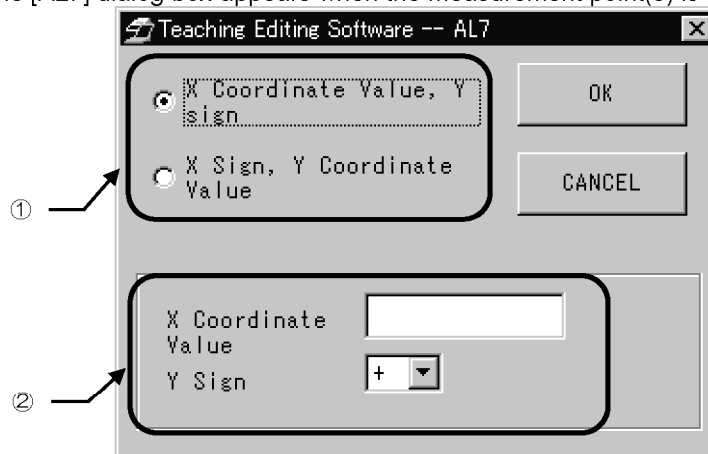

5. Select either "X coordinate value, Y sign" or "X sign, Y coordinate value" in ①.
6. Set the coordinate value and sign in ②. The display is varies depending on whether "X coordinate value, Y sign" or "X sign, Y coordinate value" is selected above.

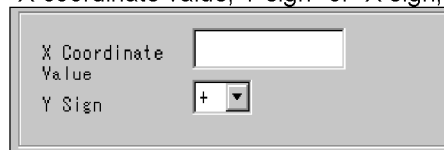

**Display when "X coordinate value, Y sign" is selected**

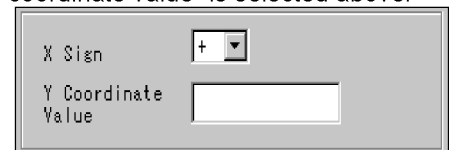

**Display when "X sign, Y coordinate value" is selected**

When "X coordinate value, Y sign" is selected above, enter the X-coordinate value in the [X Coordinate Value] text box and select the sign of the Y-coordinate Value from the [Y Sign] drop-down list.

When "X sign, Y coordinate value" is selected above, enter the Y-coordinate value in the [Y Coordinate Value] text box and select the sign of the X-coordinate value from the [X Sign] drop-down list.

When the unit of measurement is "mm", the coordinate values can be entered using 3 integer digits and 4 decimal digits. When the unit is "inch", the coordinate values can be entered using 2 integer digits and 5 decimal digits.



When a teaching program line in the teaching program line list is double-clicked, the [AL7] dialog box appears to allow you edit the program.

7. Click the <OK> button. The settings made in the [AL7] dialog box will be displayed in the teaching program line list.

If you click the <CANCEL> button, the [AL7] dialog box closes and the <AL7> button is deselected.

### 3 <AL9> button



<AL9> button

1. Click the <AL9> button.

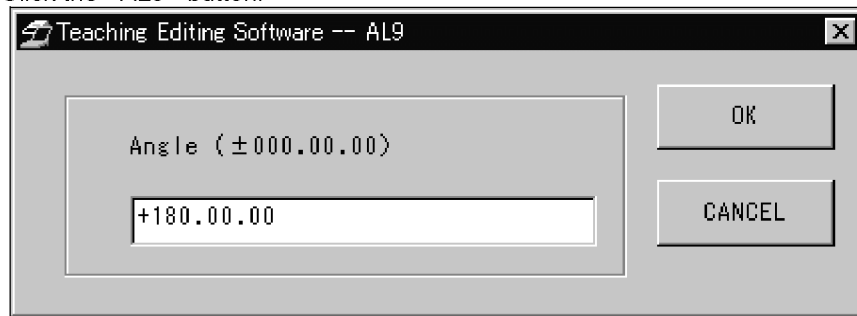

2. Enter the angle in the text box in the [AL9] dialog box. Input the angle in degree, minute and second. If the angle is to be 0, figure "0" should be input. (Example: When the angle to be set is 20°15', input "+20.15.0".)
3. Click the <OK> button. The settings made in the [AL9] dialog box will be displayed in the teaching program line list.

If you click the <CANCEL> button, the [AL9] dialog box closes and the <AL9> button is deselected.



When a teaching program line in the teaching program line list is double-clicked, the [AL9] dialog box appears to allow you edit the program.



#### 4 <AL13> button



<AL13> button

1. Click the <AL13> button.

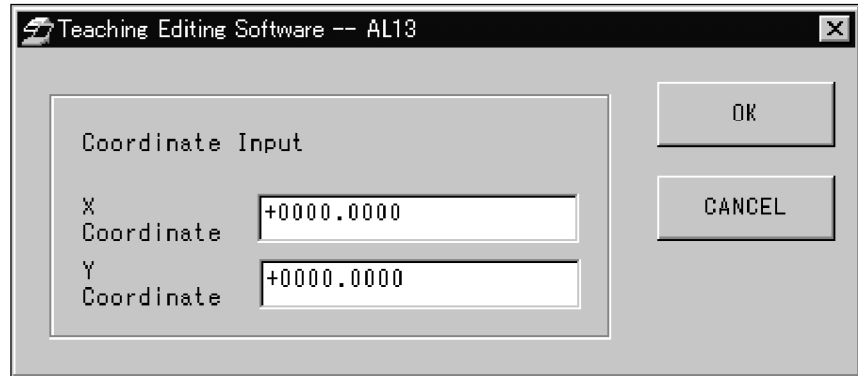

2. Enter the coordinate values in the text boxes in the [AL13] dialog box.  
When the unit of measurement is "mm", the coordinate values can be entered using 3 integer digits and 4 decimal digits. When the unit is "inch", the coordinate values can be entered using 2 integer digits and 5 decimal digits.
3. Click the <OK> button. The settings made in the [AL13] dialog box will be displayed in the teaching program line list.  
If you click the <CANCEL> button, the [AL13] dialog box closes and the <AL13> button is deselected.



When a teaching program line in the teaching program line list is double-clicked, the [AL13] dialog box appears to allow you edit the program.

### 4-4-2 [Measurement] Item Buttons

Select the measurement item to be registered in the teaching program and click the corresponding button among the [Measurement] item buttons.

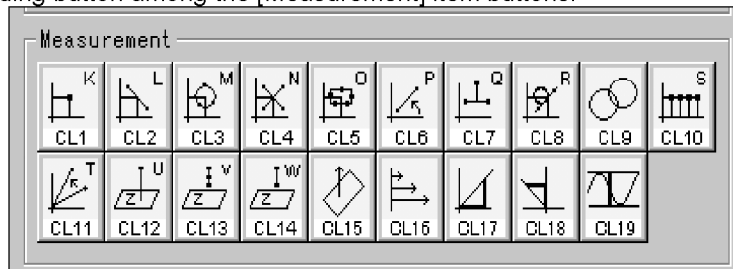

When a [Measurement] item button is clicked and the input and measurement points are entered, other buttons (except for the <IPCAL> button) cannot be selected. The input and measurement points can be confirmed in the teaching program editing situation display (below).

When these values are not "0", other buttons (except for the input point calculation button) cannot be selected. To select other buttons, click the <C> button to clear the numbers of input and measurement points to "0".

Sample No.	000		
Step No.	000		
Input Point	(20)	0 / 1	C
Measurement Point		0 / 1	
Size	1000	Bytes	

Display with multipoint measurement

Sample No.	000		
Step No.	000		
Input Point		0 / 2	C
Measurement Point		0 / 1	
Size	1000	Bytes	

Display with ordinary measurement

When a [Measurement] item button is selected, it remains displayed in the pressed-in position until the setting of the item completes. When the settings completes, the result is shown in the teaching program line list and the [Measurement] item button returns to the out position.



For the function of each of the [Measurement] item buttons, see Appendix A-2 or the instruction manual entitled "User's Manual MM6-CAL22".

The setting of the [Measurement] item buttons is variable depending on the buttons.

## 1 <CL1> to <CL16> and <CL19> buttons

Click one of these [Measurement] item buttons and select the measurement point from the [Input Property] buttons. (With CL12, CL13, CL14, CL15 and CL19, the measurement point selection is not required because their input property is fixed to the 1-point input.)

## 2 <CL17> and <CL18> buttons



<CL17> button



<CL18> button

1. Click the <CL17> and <CL18> buttons
2. Select the measurement point using the [Input Property] buttons.
3. Click the <DATA> button until getting the input point.

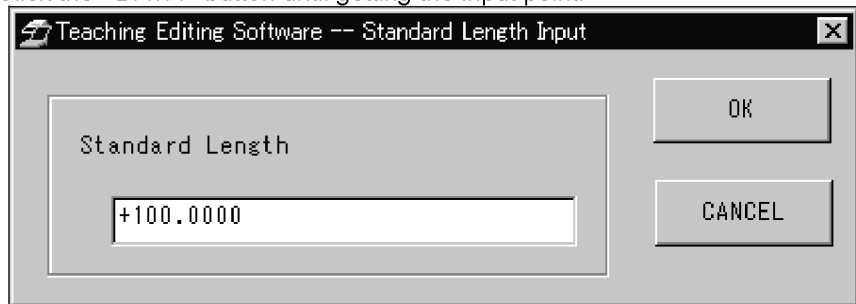

4. Enter the standard length in the [Standard Length Input] dialog box.  
When the unit of measurement is "mm", the coordinate values can be entered using 3 integer digits and 4 decimal digits. When the unit is "inch", the coordinate values can be entered using 2 integer digits and 5 decimal digits.
5. Click the <OK> button. The settings made in the [Standard Length Input] dialog box will be displayed in the teaching program line list.  
If you click the <CANCEL> button, the [Standard Length Input] dialog box closes and the <CL17> or <CL18> button is deselected.

### TIP

When a teaching program line in the teaching program line list is double-clicked, the [Standard Length Input] dialog box appears to allow you edit the program.

### 4-4-3 [Input Property] Buttons

Select the measurements points required for the teaching program and click the corresponding [Input Property] button.

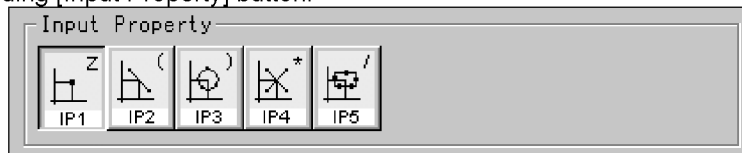

When an [Input Property] button is selected, it remains displayed in the pressed-in position until the setting of the item completes. When the settings completes, the result is shown in the teaching program line list and the [Input Property] button returns to the out position.



For the function of each of the [Input Property] buttons, see Appendix A-3 or the instruction manual entitled "User's Manual MM6-CAL22".

### 4-4-4 [Auxiliary Function] Buttons

Select the auxiliary function to be registered in the teaching program and click the corresponding button among the [Auxiliary Function] buttons.

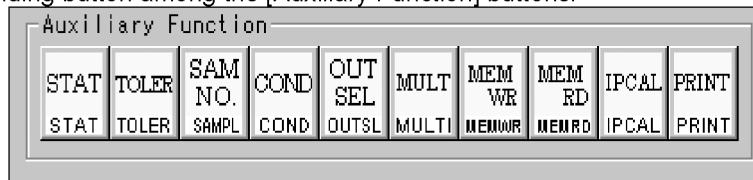

When an [Auxiliary Function] button is clicked and the input and measurement points are entered, other buttons (except for the input point calculation button) cannot be selected. The input and measurement points can be confirmed in the teaching program editing situation display (below).

When these values are not "0", other buttons (except for the input point calculation button) cannot be selected. To select other buttons, click the <C> button to clear the numbers of input and measurement points to "0".

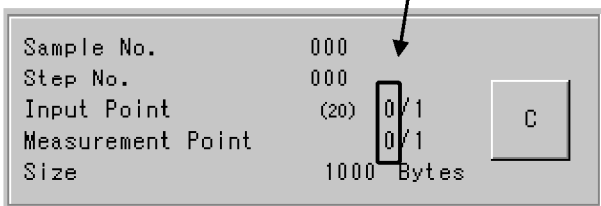

Display with multipoint measurement

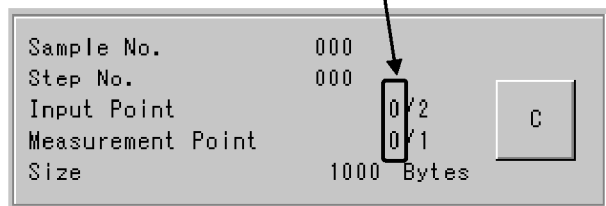

Display with ordinary measurement

When an [Auxiliary Function] button is selected, it remains displayed in the pressed-in position until the setting of the item completes. When the settings completes, the result is shown in the teaching program line list and the [Auxiliary Function] button returns to the out position.



For the function of each of the [Auxiliary Function] buttons, see Appendix A-4 or the instruction manual entitled "User's Manual MM6-CAL22".

## 1 <STAT> button



<STAT> button

Click the <STAT> button to open the [Statistics Processing] dialog box.

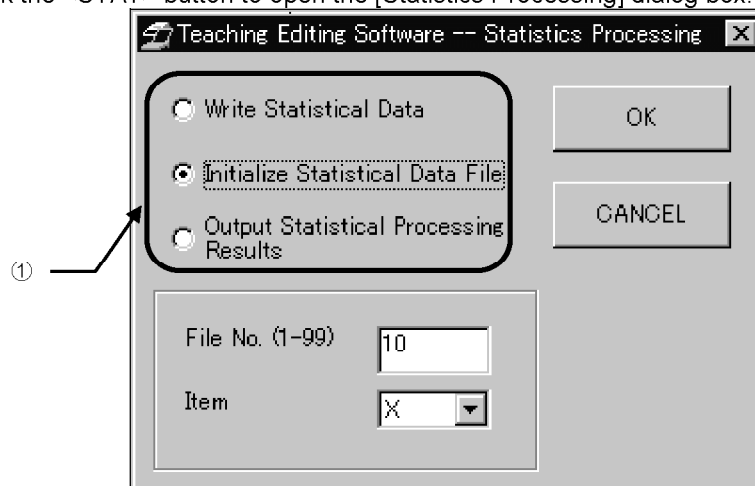

From ①, select "Write Statistical Data", "Initialize Statistical Data File" or "Output Statistical Processing Results".

Write Statistical Data:

Syntax: STAT,2,*fileno*.

Writes measurement results in a file.

Enter the file number in the [File No.] text box. The file number can be selected in the range from 1 to 99.



#### Initialize Statistical Data File

Syntax: STAT,1,*fileno*,*item*

Initializes the previously saved statistic processing items and set new ones.

In the [File No.] text box, enter the file number containing the statistic processing items to be initialized. The file number can be selected in the range from 1 to 99.

In the [Item] drop-down list, select the new statistic processing items to be set. These items can be selected from the following 15 items:

X, Y, Z, R, D, A, L, X1, Y1, R1, L1, dX, dY, dZ, dA

#### Output Statistical Processing Results

Syntax: STAT,3,*fileno*

Outputs the results of statistic processing.

In the [File No.] text box, enter the file name where the results are to be output.

Click the <OK> button. The settings made in the [Statistic Processing] dialog box will be displayed in the teaching program line list.

If you click the <CANCEL> button, the [Statistic Processing] dialog box closes and the <Statistic Processing> button is deselected.



When a teaching program line in the teaching program line list is double-clicked, the [Statistic Processing] dialog box appears to allow you edit the program.







## 2 <TOLER> button

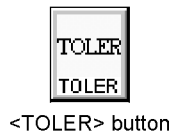

Click the <TOLER> button to open the [Tolerance Judgment] dialog box.

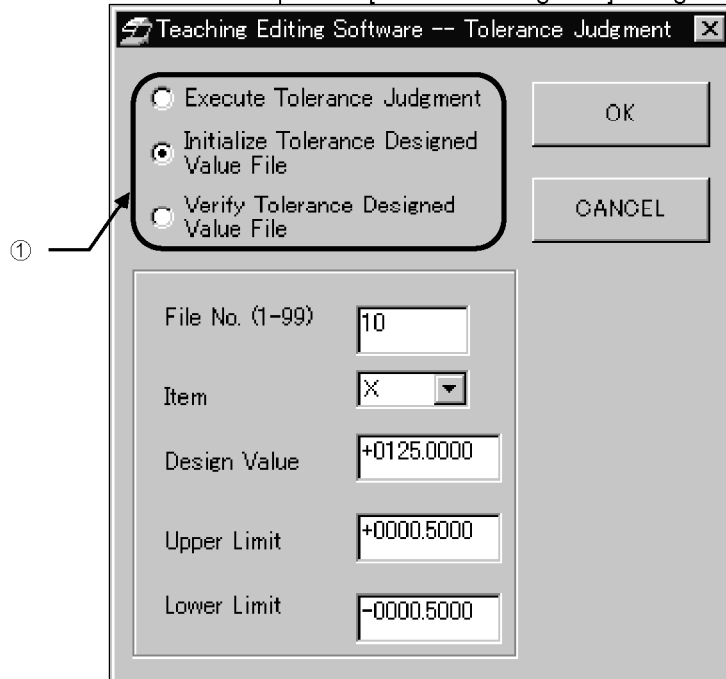

From ①, select “Execute Tolerance Judgment”, “Initialize Tolerance Designed Value File” or “Verify Tolerance Designed Value File”.

Execute Tolerance Judgment

Syntax: TOLER,2,*fileno*

Executes the judgment if the measured value matches the set condition.

Enter the file number in the [File No.] text box. The file number can be selected in the range from 1 to 99.



#### Initialize Tolerance Designed Value File

Syntax: TOLER,1,*fileno,item,designvalue,upperlimit,lowerlimit*

Initializes a tolerance design value file and set new design values.

Enter the file number in the [File No.] text box. The file number can be selected in the range from 1 to 99.

In the [Item] drop-down list, select the new tolerance judgment items to be set. These items can be selected from the following 15 items:

X, Y, Z, R, D, A, L, X1, Y1, R1, L1, dX, dY, dZ, dA

In the [Design Value] text box, enter the standard value which is used as the reference of design values.

Enter the upper limit value in the [Upper Limit] text box.

Enter the lower limit value in the [Lower Limit] text box.



If a value entered as the design value, upper limit value or lower limit value is not suitable, the text box becomes blank.

#### Verify Tolerance Designed Value File

Syntax: TOLER.3,*fileno*

Outputs the result of checking how the design values in a file are set.

Enter the file number in the [File No.] text box. The file number can be selected in the range from 1 to 99.

Click the <OK> button. The settings made in the [Tolerance Judgment] dialog box will be displayed in the teaching program line list.

If you click the <CANCEL> button, the [Tolerance Judgment] dialog box closes and the <Tolerance Judgment> button is deselected.



When a teaching program line in the teaching program line list is double-clicked, the [Tolerance Judgment] dialog box appears to allow you edit the program.





<SAMPL>  
button

### 3 <SAMPL> button

Click the <SAMPL> button to open the [Sample No. Setting] dialog box.

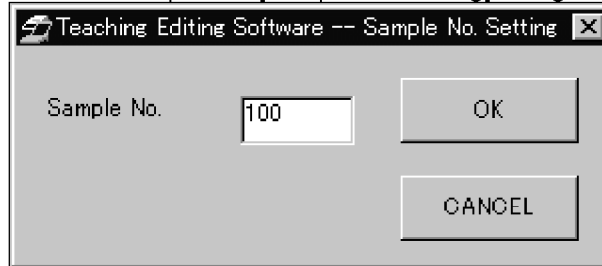

Set the sample number in an integral number between 000 and 999.

Click the <OK> button. The settings made in the [Sample No. Setting] dialog box will be displayed in the teaching program line list.

If you click the <CANCEL> button, the [Sample No. Setting] dialog box closes and the <SAMPL> button is deselected.



When a teaching program line in the teaching program line list is double-clicked, the [Sample No. Setting] dialog box appears to allow you edit the program.

### 4 <COND> button



<COND> button

Click the <COND> button to open the [Condition Setting] dialog box.

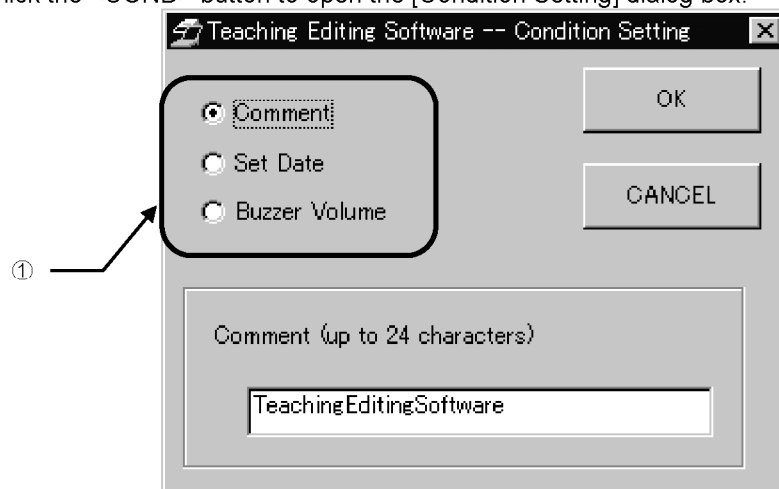

From ①, select "Comment", "Set Date" or "Buzzer Volume".



Comment

Syntax: COND,1,*comment*

Outputs the comment text before performing measurement.

Comment (up to 24 characters)

Enter a comment in the [Comment] text box using up to 24 characters.

Set Date

Syntax: COND,2,*date,time*

Sets the date and time.

Date (YYYY.MM.DD)

Time (HH:MM)

Enter Date in order of Year, Month, Day. To delimit these, enter a period (.) between them.

Enter Time in order of Hour (24-hour system) and Minute. To delimit these, enter a period (.) between them.

Buzzer volume

Syntax: COND,3,*buzzervalue*

Sets the buzzer volume.

Buzzer Volume

Adjust the buzzer volume on the scale. The volume decreases on the left and increases on the right. The volume is muted when the scale slider is set to the leftmost position.



Click the <OK> button. The settings made in the [Condition Setting] dialog box will be displayed in the teaching program line list.

If you click the <CANCEL> button, the [Condition Setting] dialog box closes and the <COND> button is deselected.



When a teaching program line in the teaching program line list is double-clicked, the [Condition Setting] dialog box appears to allow you edit the program.

## 5 <OUTSL> button



<OUTSL> button

Click the <OUTSL> button to open the [Output Selection] dialog box.

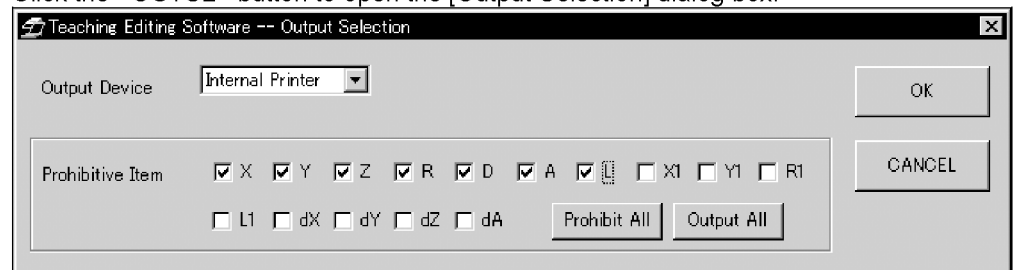

Select the output destination from the [Output device] drop-down list. The following three options are provided.

Printer OFF: Outputs the measurement results on the display, not at the printer.

Internal Printer: Outputs the results at the printer of the MM6-CAL22.

External: Transfers the result data to the PC.

In the [Prohibitive Item] group box, select the items the measurement results of which are not to be output.

This setting is required only when "Internal Printer" or "External" is selected in the [Output device] drop-down list.

To inhibit the output of an item, enter a check mark (✓) in the check box to the left of the item.

Click the <Prohibit All> button to inhibit all items.

Click the <Output All> button to output all items



Click the <OK> button. The settings made in the [Output Selection] dialog box will be displayed in the teaching program line list.

If you click the <CANCEL> button, the [Output Selection] dialog box closes and the <OUTSL> button is deselected.



When a teaching program line in the teaching program line list is double-clicked, the [Output Selection] dialog box appears to allow you edit the program.

### 6 <MULTI> button



<MULTI> button

Click the <MULTI> button to open the [Multipoint Setting] dialog box.

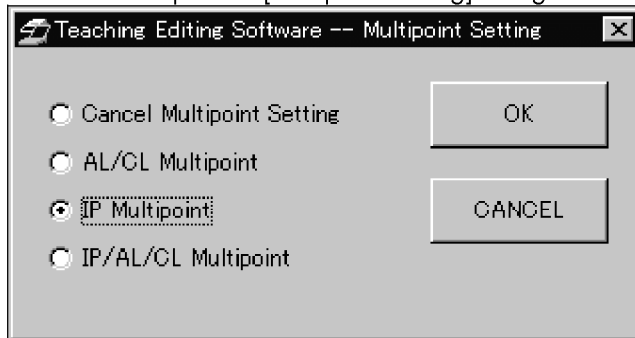

From the dialog box, select "Cancel Multipoint Setting", "AL/CL Multipoint", "IP Multipoint" or "IP/AL/CL Multipoint":

Cancel Multipoint Setting

Syntax: MULTI,1

Cancels the multipoint setting shown in the teaching program line list.

This function should be set before entering the input and measurement points.

AL/CL Multipoint

Syntax: MULTI,2

Performs multipoint measurement on the AL (alignment) and CL (measurement).

This function should be set before entering the input and measurement points.

IP Multipoint

Syntax: MULTI,3

Sets the IP (input property) to multipoint measurement. This function should be set before entering the measurement points.

IP/AL/CL Multipoint

Syntax: MULTI,4

Performs multipoint measurement on the IP (input property), AL (alignment) and CL (measurement). This function should be set before entering the input and measurement points.

Click the <OK> button. The settings made in the [Multipoint Setting] dialog box will be displayed in the teaching program line list.

If you click the <CANCEL> button, the [Multipoint Setting] dialog box closes and the <MULTI> button is deselected.



When a teaching program line in the teaching program line list is double-clicked, the [Multipoint Setting] dialog box appears to allow you edit the program.

## 7 <MEMWR> button



<MEMWR> button

Click the <MEMWR> button to open the [Memory Write] dialog box.



Enter the file number in the [File No.] text box. The file number can be selected in the range from 1 to 99.

If the measurement results in the file to be written in memory include X1Y1, select which of the results (XY or X1Y1) is to be saved using option buttons ①.



The measurement results which can be written in memory are XY, X1Y1 and Z. If the measurement results include none of them, the [Memory Write] dialog box is not displayed even when the <MEMWR> button is clicked.

Click the <OK> button. The settings made in the [Memory Write] dialog box will be displayed in the teaching program line list.

If you click the <CANCEL> button, the [Memory Write] dialog box closes and the <MEMWR> button is deselected.

**TIP** When a teaching program line in the teaching program line list is double-clicked, the [Memory Write] dialog box appears to allow you edit the program.

### 8 <MEMRD> button



<MEMRD> button

Click the <MEMRD> button to open the [Memory Read] dialog box.

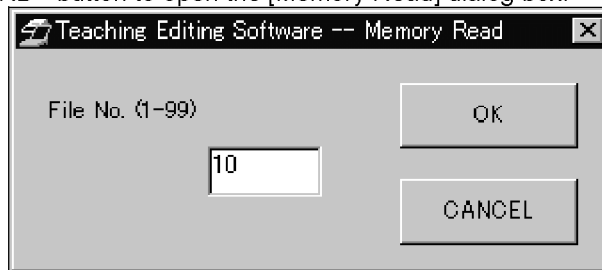

Enter the file number in the [File No.] text box. The file number can be selected in the range from 1 to 99.

**NOTE** Since memory read is not possible in flatness measurement, the [Memory Read] dialog box is not displayed in flatness measurement.

Click the <OK> button. The settings made in the [Memory Read] dialog box will be displayed in the teaching program line list.

If you click the <CANCEL> button, the [Memory Read] dialog box closes and the <MEMRD> button is deselected.





**TIP**

When a teaching program line in the teaching program line list is double-clicked, the [Memory Read] dialog box appears to allow you edit the program.

**9 <IPCAL> button**

<IPCAL> button

Click the <IPCAL> button to add the input point calculation function to the teaching program line list. The button is displayed in the pressed-in condition while it is selected. When the <IPCAL> button is clicked again after it has been selected, the button returns to the deselected condition and the input point calculation is canceled.

**TIP**

When the input point calculation setting teaching program line in the teaching program line list is double-clicked, the input point calculation function can be toggled on and off.

**10 <PRINT> button**

<PRINT> button

Click the <PRINT> button to add the function for printing the results of measurement executed immediately before to the teaching program line list. This function makes it possible to print data at the internal printer even when the output selection has been set not to print the output results on a printer.

**4-4-5 <DATA> Button**

<DATA> button

This button is used to count the measurement points for the alignment and measurement items.

Click the <DATA> button to count them in the number of measurement points shown in the [Teaching program editing situation] display.

**TIP**

The same effect as clicking the <DATA> button is also available by pressing the space key on the keyboard.

**4-4-6 <ENT> Button**

<ENT> button

This button is used to delimits the multiple points after completing successive measurements of the alignment items, measurement items and auxiliary functions.

**TIP**

The same effect as clicking the <ENT> button is also available by pressing the ENTER key on the keyboard.

**4-4-7 Teaching Program Editing Situation Display**

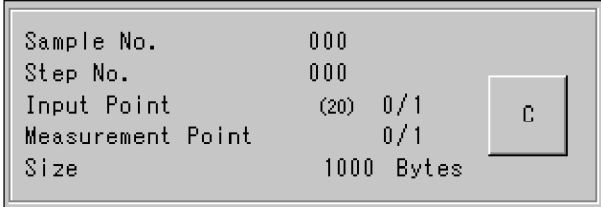

Display with multipoint measurement

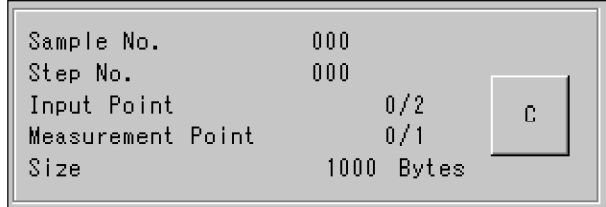

Display with ordinary measurement

Sample No. : Shows the current sample number. For the method of changing the sample number, see section 4-4-4-3.

Step No. : Shows the current step number. The step number increments by 001 when an input point calculation result, measurement result or pitch measurement result is output. It is reset to 000 when the sample number is changed.

Input Point : Shows the number of points required for the alignment or measurement and the number of actually input points.

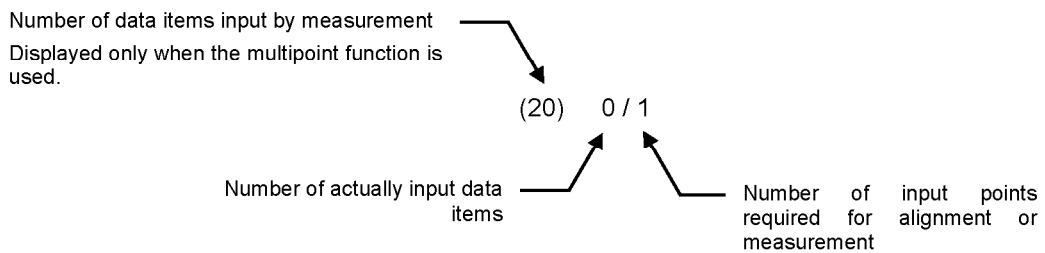

Measurement Point : Shows the number of points required for measuring the input points and the number of actually input points.

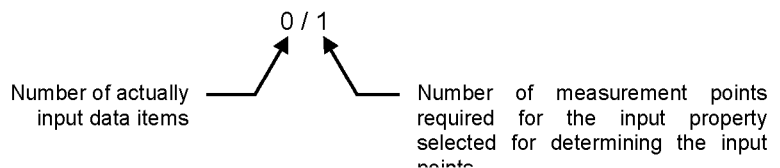

Size : Shows the program size. The size value is updated every time the program is changed.

<C> button: Cancels the alignment item or measurement item being processed.

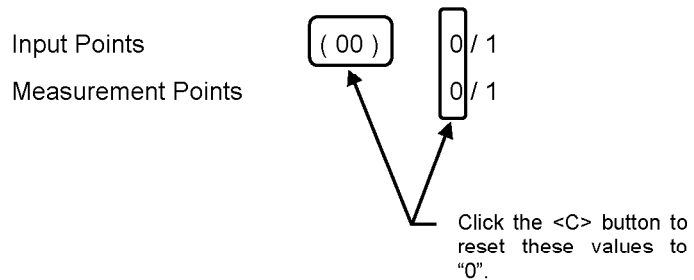

**TIP**

The same effect as clicking the <C> button is also available by pressing the Esc key on the keyboard.

#### 4-4-8 <OK> Button

This button is used to end teaching program editing and save the program being selected.

1. Click the <OK> button to open the [Select File No.] dialog box.

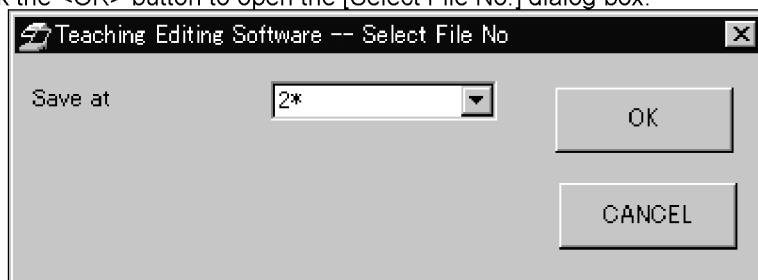

2. Select the file number to be saved from the [Save at] drop-down list. The file number can be selected in the range from 1 to 128. Asterisk "\*" on the top right of a number indicates that there is already a program saved with that number.

Click the <OK> button in the [Select File No.] dialog box to determine and save the file number. If you click the <CANCEL> button, the [Edit] window is displayed without saving the program.

If a program already exists in the selected save file number, the [Check Overwrite] dialog box appears.

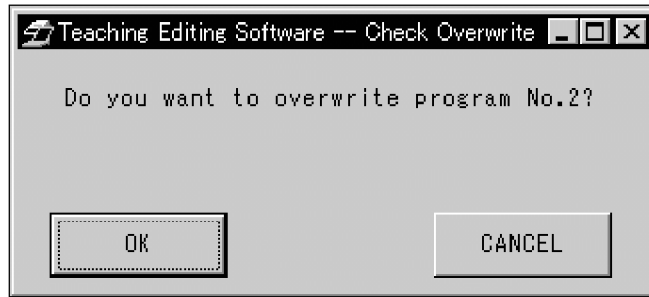

Click the <OK> button to overwrite the existing program.

Click the <CANCEL> button to cancel the program overwriting.

When the above operation completes, the [Edit] window closes and the [Main] window is displayed again.

#### 4-4-9 <CANCEL> Button

This button is used to close the [Edit] window without saving the program being selected.

## 4-4-10 Teaching Program Line List

The teaching program line list shows the lines of the selected teaching program.

Although each line basically contains the contents of one measurement, there are also some exceptions

Example 1:

```
CL2 IP1 IP1
```

Example 2

```
CL2 IP2
```

```
  O IPCAL,2 IP1
```

The 2nd and subsequent lines are indented.

Example 3

```
CL10,IP1,IP1,IP1,...
```

```
  O IP1,IP1,ENT
```

The 2nd and subsequent lines are indented.

Example 1 shows a general display method.

Example 2 shows part of a program in which an auxiliary function is inserted between measurement items. The line in which the auxiliary function is inserted extends over more than one line. The second and subsequent lines are indented to indicate that they are continued from the measurement in the previous line.

Example 3 shows a series of successive measurements which cannot be accommodated in a single line. The second and subsequent lines are indented to indicate that they are continued from the measurement in the previous line.





For how to read the program (its syntax), see Appendix C.

Program lines can be deleted, copied, pasted or modified in the teaching program line list. For details, see Appendix B.





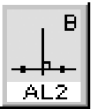
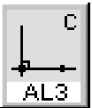
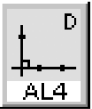

# APPENDIX A ICON LIST

## A-1 Alignment Items

Key	Function Details	Abbreviation	Ref in MM6-CAL22 Manual
	Parallel shifting of the X- and Y-axes so that input point 1 becomes the origin.	AL1	2-1-1
	Setting of the line passing input points 1 and 2 as the X-axis, and the midpoint between input points 1 and 2 as the origin.	AL2	2-1-2
	Setting of the line passing input points 1 and 2 as the X-axis, and input point 1 as the origin.	AL3	2-1-3
	Setting of the line passing input points 1 and 2 as the X-axis, and the line which passes input point 3 and is perpendicular to the X-axis as the Y-axis.	AL4	2-1-4
	Setting of a line which is parallel to the line passing input points 1 and 2 as the X-axis, and input point 3 as the origin.	AL5	2-1-5
	Setting of the line passing input points 1 and 2 as the X-axis, and the intersection point between the line passing input points 3 and 4 and the X-axis as the origin.	AL6	2-1-6

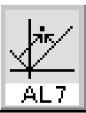
APPENDIX A ICON LIST/Alignment Items

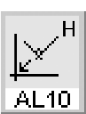

Key	Function Details	Abbreviation	Ref in MM6-CAL22 Manual
 <p>AL7</p>	<p>When the user inputs input point 1, then inputs either the X-coordinate value and Y-coordinate sign or the X-coordinate sign and Y-coordinate value of input point 1, the coordinate system is rotated so that input point 1 takes the set value and sign.</p>	AL7	2-1-7
 <p>AL8</p>	<p>Rotation of the coordinate system so that input point 1 is always located on the X-axis, but without changing the origin.</p>	AL8	2-1-8
 <p>AL9</p>	<p>Rotation of the coordinate system by angle A which is input in numerical value.</p>	AL9	2-1-9
 <p>AL10</p>	<p>Returning to the previous coordinate system set.</p>	AL10	2-1-10
 <p>AL11</p>	<p>Parallel shifting of the Z-coordinate value of the origin so that the origin is located on the plane including input point 1.</p>	AL11	2-1-11
 <p>AL12</p>	<p>Returning of the currently set coordinate system to initial coordinate system set in booting.</p>	AL12	2-1-12





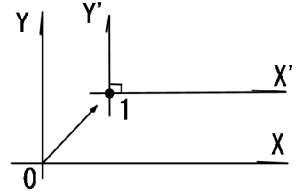

Key	Function Details	Abbreviation	Ref in MM6-CAL22 Manual
	<p>Parallel shifting of the coordinate system so that the origin becomes the point specified by the X- and Y-coordinate values which are input from the keyboard.</p>	AL13	2-1-13



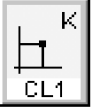

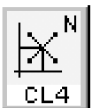

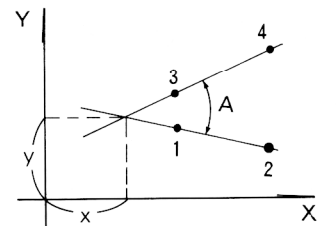
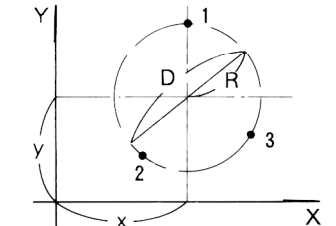
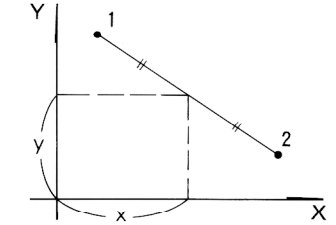
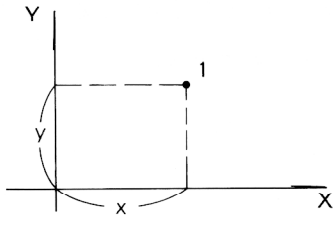
**A-2 Measurement Items**



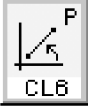
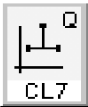

Key	Function Details	Abbreviation	Ref in MM6-CAL22 Manual
	<p>Measurement of the X- and Y-coordinate values of an input point.</p>	CL1	2-2-1
	<p>Measurement of the coordinate values of the midpoint of input points 1 and 2.</p>	CL2	2-2-2
	<p>Measurement of the diameter, radius and center coordinates of a circle formed by input points 1, 2 and 3.</p>	CL3	2-2-3
	<p>Measurement of the coordinates of the intersection point and angle of intersection A between the two lines formed by input points 1 and 2 and input points 3 and 4 respectively.</p>	CL4	2-2-4



APPENDIX A ICON LIST/Measurement Items

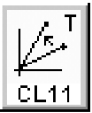
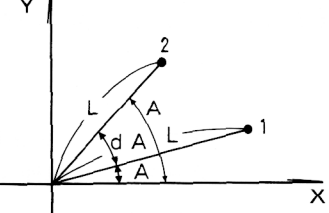
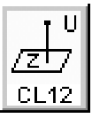
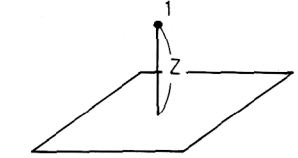

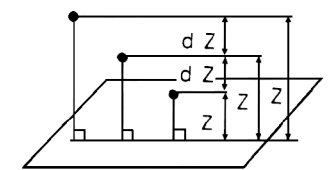
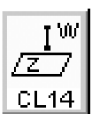
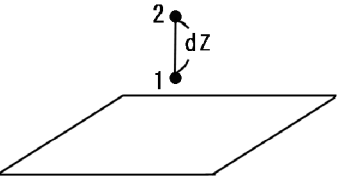

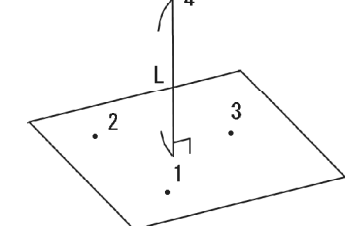
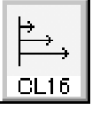
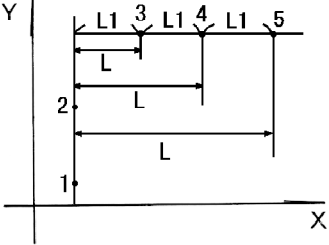
Key	Function Details	Abbreviation	Ref in MM6-CAL22 Manual
	<p>Measurement of the lengths of sides and the center coordinate values of the rectangle passing input points 1, 2, 3, 4 and 5.</p>	CL5	2-2-5
	<p>Measurement of the angle between the line passing input points 1 and 2 and the X-axis, as well as the length (distance), the difference in X-coordinate value and the difference in Y-coordinate value between the two input points.</p>	CL6	2-2-6
	<p>Measurement of the length of the perpendicular line drawn from input point 3 to the line formed by input points 1 and 2.</p>	CL7	2-2-7
	<p>Measurement of the coordinate values of the intersection points between the circle passing input points 1, 2 and 3 and the line passing input points 4 and 5, and the radius of the above circle.</p>	CL8	2-2-8
	<p>Measurement of the coordinate values of the points of intersection between the circle passing input points 1, 2 and 3 and the circle passing input points 4, 5 and 6, as well as the radii of the two circles.</p>	CL9	2-2-9
	<p>Measurement of the X- and Y-coordinate values of each input point, the differences in X- and Y-coordinate values from the previous input point, and the length (distance) from the previous input point.</p>	CL10	2-2-10

Key	Function Details	Abbreviation	Ref in MM6-CAL22 Manual
 <p>CL11</p>	<p>Measurement of the length (distance) of an input point from the origin, the angle of the line from the origin to the input point with respect to the X-axis, and the difference in angle with respect to the X-axis from the previous input point.</p>		<p>CL11</p> <p>2-2-11</p>
 <p>CL12</p>	<p>Measurement of the Z-axis distance from a reference plane to an input point.</p>		<p>CL12</p> <p>2-2-12</p>
 <p>CL13</p>	<p>Measurement of the Z-coordinate value of the plane where an input point is located, and the difference in Z-axis distance from the plane where the previous input point is located.</p>		<p>CL13</p> <p>2-2-13</p>
 <p>CL14</p>	<p>Measurement of the difference in height between two points input at different heights.</p>		<p>CL14</p> <p>2-2-14</p>
 <p>CL15</p>	<p>Measurement of the length of a perpendicular line from input point 4 to the plane formed by input points 1, 2 and 3.</p>		<p>CL15</p> <p>2-2-15</p>
 <p>CL16</p>	<p>Setting of a line passing input points 1 and 2 (endline), and measurement of the length (distance) from another input point to the endline and the difference in length from the previous input point.</p>		<p>CL16</p> <p>2-2-16</p>

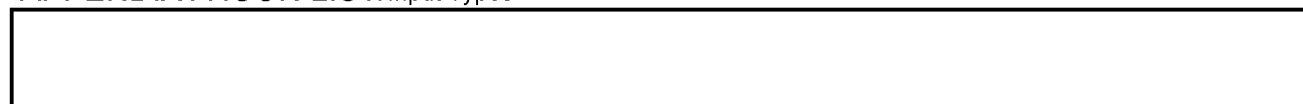



APPENDIX A ICON LIST/Input Types



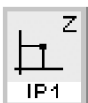





Key	Function Details	Abbreviation	Ref in MM6-CAL22 Manual
 CL17	Setting of a line passing input points 1 and 2 and a line passing input points 3 and 4, and measurement of the angle of intersection between the two lines and the difference in length between a key input value and them.	CL17	2-2-17
 CL18	Measurement of the coordinate values of the point of intersection between a line passing input points 1 and 2 and a line passing input points 3 and 4, and the deviation (with respect to 90 degrees) of the intersection angle of the two lines, as well as the measurement of the difference in distance between a key input value and each of two lines as the representation of squareness.	CL18	2-2-18
 CL19	Measurement of differences in height between some arbitrarily input points on a plane by comparing the points with highest and lowest Z-axis values, as the representation of flatness.	CL19	2-2-19

**A-3 Input Types**





Key	Function Details	Abbreviation	Ref in MM6-CAL22 Manual
 IP1	Direct Coordinate Input (1-Point input): Used to input the points as direct data. The data of the measurement points are processed as the input point data.	IP1	2-3-1

Key	Function Details	Abbreviation	Ref in MM6-CAL22 Manual
	<p>Midpoint Measuring (2-Point input): Used when an input point is located at the midpoint between two points. The midpoint coordinates of the two measurement points are processed as the input point data.</p>	IP2	2-3-2
	<p>Circle Center Input (3-Point input): Used when an input point is located at the center of a circle. The center coordinates of the circle formed by three measurement points are processed as the input point data.</p>	IP3	2-3-3
	<p>Two-Line Intersection Input (4-Point input): Used when an input point is located at the intersection point of two lines. The coordinates of the point of intersection between two lines formed by two pairs of measurement points are processed as the input point data.</p>	IP4	2-3-4
	<p>Square Hole Center Input (5-Point input): Used when an input point is located at the center of a rectangle. The center coordinates of the rectangle, which is formed by a side formed by two measurement points and three more measurement points, are processed as the input point data.</p>	IP5	2-3-5

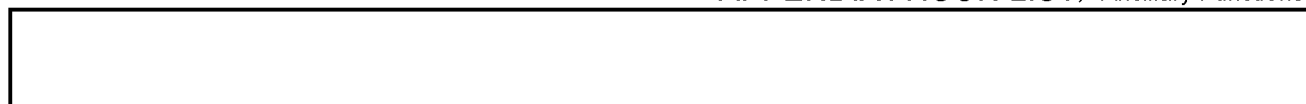
**A-4 Ancillary Functions**

Key	Name	Function Details	Remark	Abbreviation	Ref in MM6-CAL22 Manual
	Statistical processing	Used to execute statistical processing based on the measurement results. { Averaging [AVR] Standard deviation [S] Maximum value [MAX] Minimum value [MIN] Number of samples [N]	Up to 99 files can be saved.	STAT	2-4-4
	Tolerance judgment	Judges whether a measurement value is within the designed tolerance and for measuring the difference between the measured value and design value. { Within tolerance : OK Outside tolerance : NG Difference between measured value and design value : DEV	Up to 99 files can be saved.	TOLER	2-4-5
	Sample No. setting	Sets the sample number.	Select a number from 000 to 999.	SAMPL	2-4-7
	Condition	Sets prints comment.	Max. 24 characters can be input.	COND	2-4-6
		Sets the date (auto calendar).	The date is printed when the main switch is set to "I" (ON) or the reset key is pressed.		
		Sets the buzzer volume.	The buzzer sound can be muted.		
	Output selection	Switches the printer ON/OFF or makes printing setup of any measurement results.		OUTSL	2-4-3
	Multipoint measurement	Used in multipoint measurement for alignment items, measurement items and input types.	Max. 20 points can be input for planes, circles, lines and points.	MULTI	2-4-1



Key	Name	Function Details	Remark	Abbreviation	Ref in MM6-CAL22 Manual
	Memory write	Stores the coordinate values in the measurement results in the built-in memory: { X- and Y-coordinate values Z-coordinate values X1- and Y1-coordinate values	Up to 99 files can be saved.	MEMWR	2-4-9
	Memory read	Uses the coordinate values stored in the built-in memory in place of data from the counter.		MEMRD	2-4-10
  	Input point calculation  Print	Outputs the calculation results also on the input type.  When the printer setup is OFF, used to output the displayed measurement results at the printer.	The results are output in the same way as the measurement results.	IPCAL  PRINT	2-4-2  2-4-14





# APPENDIX B Delete, Copy, Paste and Modify

This section describes the operating methods to delete, copy, paste, and modify the program in the teaching Program line list.

## B-1 Delete

To define the area of the program to be deleted, select the program in which its respective measurement completes.

e.g. 1: CL2 IP1 IP1

e.g. 2 : CL2 IP1  
IPCAL , 2 IP1

More than one programs containing their respective measurements can be deleted at once if the programs are arranged serially.

In the following example, lines of AL4 to CL3 can be deleted simultaneously if they are included in an area. Lines of AL4 and CL3 alone cannot be deleted at once.

e.g. : AL4 IP1 IP1 IP1  
CL2 IP1  
IPCAL , 2 IP1  
CL3 IP1 IP1 IP1



Two operating methods are provided to define the area including the lines of serial programs.

- Drag the lines with mouse.
- Select the line to start the area, then select the line to end holding down the <Shift> key.

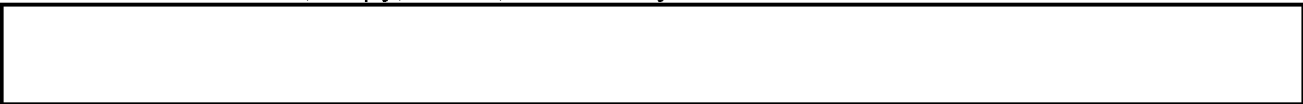

In execution of deletion, the selected area are entirely deleted or otherwise.

The selected area are entirely deleted :

- when multipoint measurement is not included
- when the contents of multipoint measurements described just above and below the area are completely the same
- when the end of the area comes to the final line of the programs.

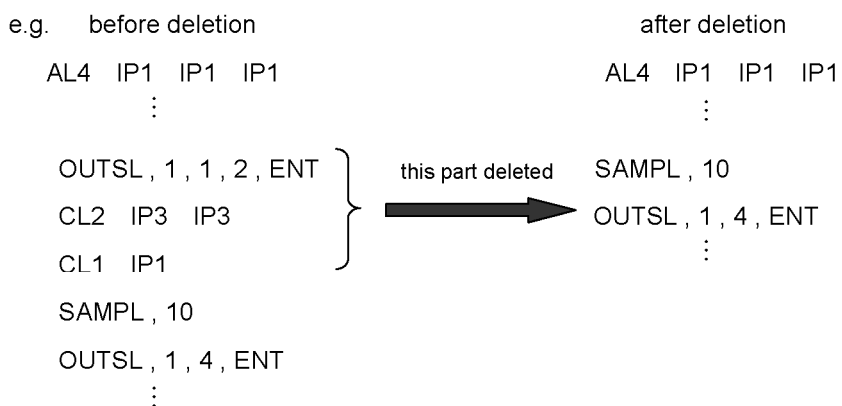

The selected area are not entirely deleted :

- when the contents of multipoint measurement described just above and below the area are different.

In this case, the last multipoint measurement included in the selected area remains.

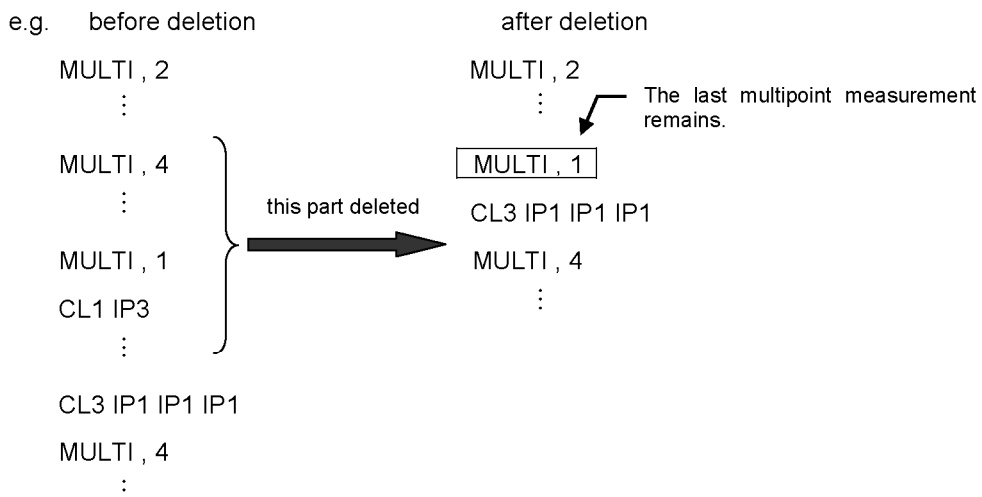

**B-2 Copy**

To define the area of the program to be copied, select the program in which its respective measurement completes.

e.g. 1 : CL2 IP1 IP1

e.g. 2 : CL2 IP1

IPCAL , 2 IP1

More than one programs containing their respective measurements can be copied at once if the programs are arranged serially.

In the following example, lines of AL4 to CL3 can be copied simultaneously if they are included in an area. Lines of AL4 and CL3 alone cannot be copied at once.

e.g. : AL4 IP1 IP1 IP1

CL2 IP1

IPCAL , 2 IP1

CL3 IP1 IP1 IP1



Two operating methods are provided to define the area including the lines of serial programs.

- Drag the lines with mouse.
- Select the line to start the area, then select the line to end holding down the <Shift> key.

Simply the last information of copy is recorded in selecting copy. The second last information has already erased.

**B-3 Paste**

Paste the information copied in advance.

Where the copied information is pasted on comes before the cursor. The contents to be pasted is simply the copied information or otherwise.

Simply the copied information is pasted on :

- where multipoint measurement is not described before or behind the cursor.
- where the same multipoint measurement as the copied information is described before or behind the cursor.

e.g. : Paste the program of "OUTSEL 2,4,ENT" between AL4 and CL3

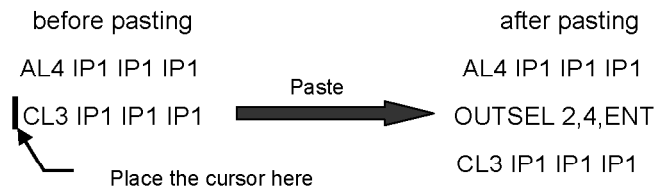

Other than the copied information is pasted on :

- where another multipoint measurement than that in the copied information is described before or behind the cursor, if the copied information includes the multipoint measurement. In this case, the copied multipoint measurement has priority.

e.g. : Copy "CL1 IP1 IP1 IP1 ENT" in the programs and paste below the program of "CL3 IP1 IP1 IP1".

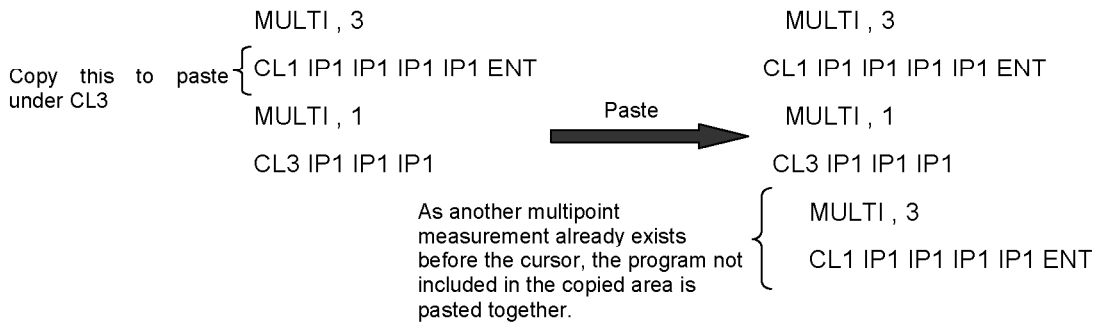

## B-4 Modify

Modify the program. Double-clicking the line of the program can be modified displays the dialog box. Modify the settings in this displayed dialog box.

e.g. : Modify Statistics Processing function. The following program writes the measurement result in the file No. 20 and "X" in the item of the measurement result.

```
STAT , 2 , 10 , 1
```

Modify this item of the measurement result to be written to "Y".

1. Double-click on "STAT , 2 , 10 , 1" in the teaching program line list. Then the [Statistics Processing] dialog box appears.

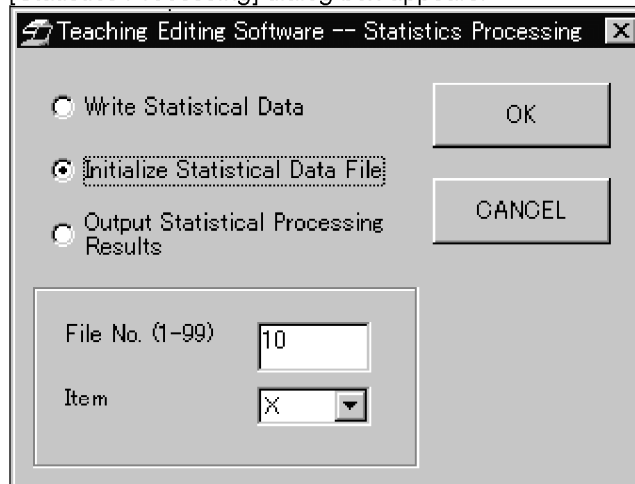

2. Change "X" in the item into "Y".
3. Click the <OK> button to close the dialog box. Then the program is modified as following.

After the modification : STAT , 2 , 10 , 2



# APPENDIX C SYNTAX DESCRIPTION

This appendix describes how a program is described in the teaching program line list.

The syntax is described according to the following notation rule.

Notation	Description
[A]	The description inside [ ] may be unnecessary according to the context.
...	Multiple input properties or output inhibited items can be described. (The output inhibited items should be delimited with comma.)

## C-1 Alignment Items

Press the desired [Alignment] item button to describe the program for the selected alignment item in the teaching program line list.

### C-1-1 AL1

<< Description in ordinary measurement >>

**AL1 IP**

AL1: Description of the selected alignment item.

IP: Description of the input property (1-point to 5-point input) or memory read.

<< Description in multipoint measurement >>

**AL1 { IP IP ... } ENT**

The origin is determined.

AL1 : Description of the selected alignment item.

IP : Description of the input property (1-point to 5-point input) or memory read.

... : Description of more than one IP (up to 20 points).

ENT : Description the end of input point description.

**C-1-2 AL2**

<< Description in ordinary measurement >>

**AL2** *IP IP*

AL2 : Description of the selected alignment item.

*IP* : Description of the input property (1-point to 5-point input) or memory read.

<< Description in multipoint measurement >>

**AL2**  $\underbrace{IP\ IP\ \dots}_{\text{Input point 1 is determined.}}ENT$       $\underbrace{IP\ IP\ \dots}_{\text{Input point 2 is determined.}}ENT$

AL2 : Description of the selected alignment item.

*IP* : Description of the input property (1-point to 5-point input) or memory read.

*...* : Description of more than one *IP* (up to 20 points).

ENT : Description the end of input point description.

**C-1-3 AL3**

<< Description in ordinary measurement >>

**AL3** *IP IP*

AL3 : Description of the selected alignment item.

*IP* : Description of the input property (1-point to 5-point input) or memory read.

<< Description in multipoint measurement >>

**AL3**  $\underbrace{IP\ IP\ \dots}_{\text{The origin is determined.}}ENT$       $\underbrace{IP\ IP\ \dots}_{\text{The X-axis is determined.}}ENT$

AL3 : Description of the selected alignment item.

*IP* : Description of the input property (1-point to 5-point input) or memory read.

*...* : Description of more than one *IP* (up to 20 points).

ENT : Description the end of input point description.



**C-1-4 AL4**

<< Description in ordinary measurement >>

**AL4** *IP IP IP*

AL4 : Description of the selected alignment item.

*IP* : Description of the input property (1-point to 5-point input) or memory read.

<< Description in multipoint measurement >>

**AL4**  $\underbrace{IP\ IP\ \dots}_{}$ ENT  $\underbrace{IP\ IP\ \dots}_{}$ ENT

The X-axis is determined.

The Y-axis is determined

AL4 : Description of the selected alignment item.

*IP* : Description of the input property (1-point to 5-point input) or memory read.

*...* : Description of more than one *IP* (up to 20 points).

ENT : Description the end of input point description.

**C-1-5 AL5**

<< Description in ordinary measurement >>

**AL5** *IP IP IP*

AL5 : Description of the selected alignment item.

*IP* : Description of the input property (1-point to 5-point input) or memory read.

<< Description in multipoint measurement >>

**AL5**  $\underbrace{IP\ IP\ \dots}_{}$ ENT  $\underbrace{IP\ IP\ \dots}_{}$ ENT

The line parallel to the X-axis is determined.

The origin is determined

AL5 : Description of the selected alignment item.

*IP* : Description of the input property (1-point to 5-point input) or memory read.

*...* : Description of more than one *IP* (up to 20 points).

ENT : Description the end of input point description.

**C-1-6 AL6**

<< Description in ordinary measurement >>

**AL6** *IP IP IP IP*

AL6 : Description of the selected alignment item.

*IP* : Description of the input property (1-point to 5-point input) or memory read.

<< Description in multipoint measurement >>

**AL6**  $\underbrace{IP \ IP \ \dots}_{}$ ENT       $\underbrace{IP \ IP \ \dots}_{}$ ENT

The X-axis is  
determined.

The line is  
determined

AL6 : Description of the selected alignment item.

*IP* : Description of the input property (1-point to 5-point input) or memory read.

*...* : Description of more than one *IP* (up to 20 points).

ENT : Description the end of input point description.

**C-1-7 AL7**

<< Description in ordinary measurement >>

**AL7 *IP* , *XCOORD* , *YSIGN* or AL7 *IP* , *XSIGN* , *YCOORD***

*AL7* : Description of the selected alignment item.

*IP* : Description of the input property (1-point to 5-point input) or memory read.

*XCOORD* : Description of the X-coordinate value of *IP*.

*YCOORD* : Description of the Y-coordinate value of *IP*.

*XSIGN* : Description of the X-axis sign of *IP*.

*YSIGN* : Description of the Y-axis sign of *IP*.

<< Description in multipoint measurement >>

**AL7 *IP IP ... ENT* , *XCOORD* , *YSIGN***

or

**AL7  $\underbrace{IP IP \dots}$  ENT , *XSIGN* , *YCOORD***

The point where the coordinate value and sign are set is determined.

*AL7* : Description of the selected alignment item.

*IP* : Description of the input property (1-point to 5-point input) or memory read.

*...* : Description of more than one *IP* (up to 20 points).

*XCOORD* : Description of the X-coordinate value of *IP*.

*YCOORD* : Description of the Y-coordinate value of *IP*.

*XSIGN* : Description of the X-axis sign of *IP*.

*YSIGN* : Description of the Y-axis sign of *IP*.

*ENT* : Description the end of input point description.

**C-1-8 AL8**

<< Description in ordinary measurement >>

**AL8** *IP1*

AL8 : Description of the selected alignment item.

*IP* : Description of the input property (1-point to 5-point input) or memory read.

<< Description in multipoint measurement >>

**AL8** *IP IP ...* ENT

The X-axis point is determined.

AL8 : Description of the selected alignment item.

*IP* : Description of the input property (1-point to 5-point input) or memory read.

*...* : Description of more than one *IP* (up to 20 points).

ENT : Description the end of input point description.

**C-1-9 AL9**

<< Description in all measurements >>>

**AL9** , *ANGLE*

AL9 : Description of the selected alignment item.

*ANGLE* : Angle for rotating the coordinate by the specified amount.

**C-1-10 AL10**

<< Description in all measurements >>

**AL10**

AL10 : Description of the selected alignment item.

Returns the coordinate system to the last set system.

**C-1-11 AL11**

<< Description in ordinary measurement >>

**AL11, *IP***

AL11 : Description of the selected alignment item.

*IP* : Description of the input property (1-point input only) or memory read.

<< Description in multipoint measurement >>

**AL11 *IP IP...* ENT**

The plane where the origin exists is determined.

AL11 : Description of the selected alignment item.

*IP* : Description of the input property (1-point input only) or memory read.

*...* : Description of more than one *IP* (up to 20 points).

ENT : Description the end of input point description.

**C-1-12 AL12**

<< Description in all measurements >>

**AL12**

AL12 : Description of the selected alignment item.

Returns the coordinate system to the last set system.

**C-1-13 AL13**

<< Description in all measurements >>

**AL13 *XCOORD*, *YCOORD***

AL13 : Description of the selected alignment item.

*XCOORD* : Description of the X-coordinate value of *IP*.

*YCOORD* : Description of the Y-coordinate value of *IP*.

**C-2 Measurement Items**

Press the desired [Measurement] item button to describe the program for the selected measurement item in the teaching program line list.

**C-2-1 CL1**

<< Description in ordinary measurement >>

**CL1** *IP*

CL1 : Description of the selected measurement item.

*IP* : Description of the input property (1-point to 5-point input) or memory read.

<< Description in multipoint measurement >>

**CL1** *IP IP ... ENT*

The input point is determined.

CL1 : Description of the selected measurement item.

*IP* : Description of the input property (1-point to 5-point input) or memory read.

*...* : Description of more than one *IP* (up to 20 points).

ENT : Description the end of input point description.

**C-2-2 CL2**

<< Description in ordinary measurement >>

**CL2** *IP IP*

CL2 : Description of the selected measurement item.

*IP* : Description of the input property (1-point to 5-point input) or memory read.

<< Description in multipoint measurement >>

**CL2** *IP IP ... ENT*      *IP IP ... ENT*

The first point is determined.

The second point is determined.

CL2 : Description of the selected measurement item.

*IP* : Description of the input property (1-point to 5-point input) or memory read.

*...* : Description of more than one *IP* (up to 20 points).

ENT : Description the end of input point description.

**C-2-3 CL3**

<< Description in ordinary measurement >>

**CL3 *IP IP IP***

CL3 : Description of the selected measurement item.

*IP* : Description of the input property (1-point to 5-point input) or memory read.

<< Description in multipoint measurement >>

**CL3 *IP IP ... ENT***

The periphery of the circle is determined.

CL3 : Description of the selected measurement item.

*IP* : Description of the input property (1-point to 5-point input) or memory read.

*...* : Description of more than one *IP* (up to 20 points).

ENT : Description the end of input point description.

**C-2-4 CL4**

<< Description in ordinary measurement >>

**CL4 *IP IP IP IP***

CL4 : Description of the selected measurement item.

*IP* : Description of the input property (1-point to 5-point input) or memory read.

<< Description in multipoint measurement >>

**CL4 *IP IP ... ENT IP IP ... ENT***

The first line is determined.

The second line is determined.

CL4 : Description of the selected measurement item.

*IP* : Description of the input property (1-point to 5-point input) or memory read.

*...* : Description of more than one *IP* (up to 20 points).

ENT : Description the end of input point description.

**C-2-5 CL5**

<< Description in ordinary measurement >>

**CL5** *IP IP IP IP IP*

CL5 : Description of the selected measurement item.

*IP* : Description of the input property (1-point to 5-point input) or memory read.

<< Description in multipoint measurement >>

**CL5** *{IP IP ...} ENT*      *{IP IP ...} ENT*      *{IP IP ...} ENT*      *{IP IP ...} ENT*

The first line is determined.

The line perpendicular to the first line is determined.

The line parallel with the first line is determined.

The line perpendicular to the first line is determined.

CL5 : Description of the selected measurement item.

*IP* : Description of the input property (1-point to 5-point input) or memory read.

*...* : Description of more than one *IP* (up to 20 points).

ENT : Description the end of input point description.

**C-2-6 CL6**

<< Description in ordinary measurement >>

**CL6** *IP IP*

CL6 : Description of the selected measurement item.

*IP* : Description of the input property (1-point to 5-point input) or memory read.

<< Description in multipoint measurement >>

**CL6** *{IP IP ...} ENT*      *{IP IP ...} ENT*

The first point is determined.

The second point is determined.

CL6 : Description of the selected measurement item.

*IP* : Description of the input property (1-point to 5-point input) or memory read.

*...* : Description of more than one *IP* (up to 20 points).

ENT : Description the end of input point description.



**C-2-7 CL7**

<< Description in ordinary measurement >>

**CL7 IP IP IP**

CL7 : Description of the selected measurement item.

IP : Description of the input property (1-point to 5-point input) or memory read.

<< Description in multipoint measurement >>

**CL7  $\underbrace{IP IP \dots}_{}$ ENT  $\underbrace{IP IP \dots}_{}$ ENT**

The line is determined.

The input point is determined.

CL7 : Description of the selected measurement item.

IP : Description of the input property (1-point to 5-point input) or memory read.

... : Description of more than one IP (up to 20 points).

ENT : Description the end of input point description.

**C-2-8 CL8**

<< Description in ordinary measurement >>

**CL8 IP IP IP IP IP**

CL8 : Description of the selected measurement item.

IP : Description of the input property (1-point to 5-point input) or memory read.

<< Description in multipoint measurement >>

**CL8  $\underbrace{IP IP \dots}_{}$ ENT  $\underbrace{IP IP \dots}_{}$ ENT**

The periphery is determined.

The line is determined.

CL8 : Description of the selected measurement item.

IP : Description of the input property (1-point to 5-point input) or memory read.

... : Description of more than one IP (up to 20 points).

ENT : Description the end of input point description.

**C-2-9 CL9**

<< Description in ordinary measurement >>

**CL9** *IP IP IP IP IP IP*

CL9 : Description of the selected measurement item.

*IP* : Description of the input property (1-point to 5-point input) or memory read.

<< Description in multipoint measurement >>

**CL9**  $\underbrace{IP IP \dots}_{}$  ENT       $\underbrace{IP IP \dots}_{}$  ENT

The first circle is determined.

The second circle is determined.

CL9 : Description of the selected measurement item.

*IP* : Description of the input property (1-point to 5-point input) or memory read.

*...* : Description of more than one *IP* (up to 20 points).

ENT : Description the end of input point description.

**C-2-10 CL10**

<< Description in ordinary measurement >>

**CL10** *IP IP ... ENT*

CL10 : Description of the selected measurement item.

*IP* : Description of the input property (1-point to 5-point input) or memory read.

*...* : Description of more than one *IP* (the number is unlimited).

ENT : Description the end of successive measurement.

<< Description in multipoint measurement >>

**CL10**  $\underbrace{IP IP \dots}_{}$  ENT       $\underbrace{IP IP \dots}_{}$  ENT ..... ENT

An input point is determined.

An input point is determined.

CL10 : Description of the selected measurement item.

*IP* : Description of the input property (1-point to 5-point input) or memory read.

*...* : Description of more than one *IP* (up to 20 points).

ENT : Description the end of input point description and successive measurement.

*.....* : Indication of the possibility of successive measurement.







**C-2-17 CL17**

<< Description in ordinary measurement >>

**CL17 *IP IP IP IP , STDLEN***

CL17 : Description of the selected measurement item.

*IP* : Description of the input property (1-point to 5-point input) or memory read.

*STDLEN* : Description of the standard length.

<< Description in multipoint measurement >>

**CL17 *IP IP ... ENT*      *IP IP ... ENT , STDLEN***

The first line is determined.

The second line is determined.

CL17 : Description of the selected measurement item.

*IP* : Description of the input property (1-point to 5-point input) or memory read.

*...* : Description of more than one *IP* (up to 20 points).

*ENT* : Description the end of input point description and successive measurement.

*STDLEN* : Description of the standard length.

**C-2-18 CL18**

<< Description in ordinary measurement >>

**CL18 *IP IP IP IP , STDLEN***

CL18 : Description of the selected measurement item.

*IP* : Description of the input property (1-point to 5-point input) or memory read.

*STDLEN* : Description of the standard length.

<< Description in multipoint measurement >>

**CL18 *IP IP ... ENT*      *IP IP ... ENT , STDLEN***

The first line is determined.

The second line is determined.

CL18 : Description of the selected measurement item.

*IP* : Description of the input property (1-point to 5-point input) or memory read.

*...* : Description of more than one *IP* (up to 20 points).

*ENT* : Description the end of input point description and successive measurement.

*STDLEN* : Description of the standard length.

**C-2-19 CL19**

<< Description in ordinary measurement >>

**CL19** *IP IP IP IP*

CL19 : Description of the selected measurement item.

*IP* : Description of the input property (1-point input only) or memory read.

<< Description in multipoint measurement >>

**CL19** *IP IP...* ENT

The input point on the plane is determined.

CL19 : Description of the selected measurement item.

*IP* : Description of the input property (1-point input only) or memory read.

*...* : Description of more than one *IP* (up to 20 points).

ENT : Description the end of input point description and successive measurement.

**C-3 Input Property**

Press the desired [Input Property] item button to describe the program for the selected input property in the teaching program line list.

## C-4 Auxiliary Functions

Press the desired [Auxiliary Function] button to describe the program for the selected auxiliary function in the teaching program line list.

### C-4-1 STAT (Statistics)

**STAT , sel , file [ , Item ]**

*STAT* : Description of the selected auxiliary function.

*sel* : Description in number of the statistic processing item.

1 : Initialize Statistic Processing File

2 : Write Statistic Processing Data

3 : Output Statistic Processing Results

*file* : Description of the file number.

*Item* : Description of the item used in statistic processing.

This should be described only when "Initialize" is selected in *sel*.

1 2 3 4 5 6 7 8 9 10 11 12 13 14 15  
X Y Z R D A L X1 Y1 R1 L1 dX dY dZ dA

### C-4-2 TOLER (Tolerance)

**TOLER , sel , file [ , Item , design , upper , lower ]**

*TOLER* : Description of the selected auxiliary function.

*sel* : Description in number of the tolerance judgment item.

1 : Initialize Tolerance Design Value File

2 : Execute Tolerance Judgment

3 : Check Tolerance Design Value File

*file* : Description of the file number.

*Item* : Description of the item used in tolerance judgment.

This should be described only when "Initialize" is selected in *sel*.

1 2 3 4 5 6 7 8 9 10 11 12 13 14 15  
X Y Z R D A L X1 Y1 R1 L1 dX dY dZ dA

*design* : Description of the tolerance design value.

This should be described only when "Initialize" is selected in *sel*.

*upper* : Upper tolerance limit.

This should be described only when "Initialize" is selected in *sel*.

*lower* : Lower tolerance limit.

This should be described only when "Initialize" is selected in *sel*.



**C-4-3 SAMPL (Sample Number)****SAMPL , *sampleno***

SAMPL : Description of the selected auxiliary function.

*sampleno* : Description of the sample number.**C-4-4 COND (Condition)****1 Comment****COND , 1 , *comment***

COND : Description of the selected auxiliary function.

1 : Description in number of the condition processing item (i.e. comment input).

*comment* : Description of the comment text.**2 Date setting****COND , 2 , *date* , *time***

COND : Description of the selected auxiliary function.

2 : Description in number of the condition processing item (i.e. date setting).

*date* : Description of the date (Year, Month, Day).*time* : Description of the time (Hour, Minute).**3 Buzzer volume****COND , 3 , *value***

COND : Description of the selected auxiliary function.

3 : Description in number of the condition processing item (i.e. buzzer volume setting).

*value* : Description of the buzzer volume value.

**C-4-5 OUTSL (Output Selection)**

**OUTSL , *sel* , *Item* , *Item ...* , ENT**

OUTSL : Description of the selected auxiliary function.

*sel* : Description in number of the selected output destination.

0 : Printer OFF

1 : Internal Printer

2 : External

*Item* : Description in number of the output inhibited item.

This should be described only when "Initialize" is selected in *sel*.

0	1	2	3	4	5	6	7	8	9	10	11	12	13	14	15	99
All-item	X	Y	Z	R	D	A	L	X1	Y1	R1	L1	dX	dY	dZ	dA	All-item
inhibited																output

*...* : Description of all output inhibited items if multiple items are selected.

ENT : End of output selection.

**C-4-6 MULTI (Multipoint)**

**MULTI , *sel***

MULTI : Description of the selected auxiliary function.

*sel* : Description of the multipoint measurement setting.

1 : Cancel multipoint setting

2 : AL/CL multipoint measurement

3 : IP multipoint measurement

4 : AL/CL/ IP multipoint measurement

**C-4-7 MEMWR (Memory Write)**

**MEMWR , *file* , *xytype***

MEMWR : Description of the selected auxiliary function.

*file* : Description of the file number.

*xytype* : Description of the result items to be written in memory.

1 : X, Y

2 : X1, Y1

3 : Z

**C-4-8 MEMRD (Memory Read)**

MEMRD , *file*

MEMWR : Description of the selected auxiliary function.

*file* : Description of the file number.

**C-4-9 IPCAL (Input Point Calculation)**

IPCAL , *flag*

IPCAL : Description of the selected auxiliary function.

*flag* : Description of the input point calculation status.

1 : Input point calculation is not set.

2 : Input point calculation is set.



The <IPCAL> button is displayed in the pressed-in position when input point calculation is set. When it is not set, the button is displayed in the out position.

**C-4-10 PRINT**

PRINT

PRINT : Description of the selected auxiliary function.

This function makes it possible to print data at the internal printer even when the output selection has been set not to print the output results on a printer.



# APPENDIX D Troubleshooting Guide

Under certain conditions, performance of this system may be adversely affected by factors other than defects. If a problem occurs, refer to the following list and take remedial action as needed.

If you cannot solve the problem after checking the entire list, please contact your local Olympus representative for assistance.

## 1 The Teaching Editing software cannot be started up

Check Items	Treatment	Manual Ref.
① Check the connection of the dongle for the Teaching Editing software to the computer.	The Teaching Editing software cannot be started up unless the dongle for this software is attached to the computer. Turn all the powers OFF to attach the dongle for this software included in the Teaching Editing software system. Then turn the powers ON and start up the Teaching Editing software again.	Sec.1-3 Sec.1-6
② Refer to Sec.1-2-1 to confirm that the Teaching Editing software has properly been installed.	If installing of the Teaching Editing software has failed, install the software again and restart the computer. Then start up the Teaching Editing software.	Sec.1-2 Sec.1-6

**The Dongle may be damaged if the Teaching Editing software still cannot be started even in the condition that the dongle for the Teaching Editing software is properly attached and the Teaching Editing software is successfully installed. In this case, please contact your local Olympus representative for assistance.**

## 2 The computer cannot communicate with MM6-CAL22

Check Items	Treatment	Manual Ref.
① Ensure that the cable is correctly connected.	Correctly connect the enclosed cable between MM6-CAL22 and computer. If the receptacle on the computer is not for the serial cable, use the appropriate conversion connector.	Sec.1-4
② Ensure that the correct cable is being used.	Use the enclosed "RS-232C cross cable". If the receptacle on the computer is not for this cable, use the appropriate conversion connector.	Sec.1-4
③ Ensure that the " MAINTENANCE MODE PC CONNECTING" message appears on the LCD display of MM6-CAL22.	MM6-CAL22 is not started up in Maintenance mode. Start up the MM6-CAL22 in Maintenance mode. Then restart the Teaching Editing software.	Sec.1-5 Sec.1-8-1

## APPENDIX D Troubleshooting Guide

Check Items	Treatment	Manual Ref.
④ Ensure that the communication settings of MM6-CAL22 corresponds to the communication settings of the Teaching Editing software.	Before restart the Teaching Editing software, meet the settings of the DIP switch on the MM6-CAL22 rear panel to the communication settings of the Teaching Editing software. If the computer still cannot communicate with MM6-CAL22, lower the communication rate.	Sec.1-4-2 Sec.1-8
⑤ Check the height of the value for the buffer setting of the communication port being used.	<ol style="list-style-type: none"> <li>1. Select the &lt;Start&gt; button on the task bar to display the [Start] menu, then select the [Settings] and click the [Control Panel].</li> <li>2. Select [System] in the [Control Panel] dialog box. The [System Properties] dialog box appears.</li> <li>3. Select the [Device Manager] tab in the [System Properties] dialog box. In this tab, select the &lt;View devices by type&gt; option button, double-click "Ports(COM&amp;LPT)", and click the &lt;Properties&gt; button while selecting the communication port in use (COM1 or COM2). Then the [Communication Port(COM1 or COM2)Properties] dialog box appears.</li> <li>4. Select the [Port Settings] tab in the [Communication Port(COM1 or COM2)Properties] dialog box and click the &lt;Advanced&gt; button. The [Advanced Port Settings] dialog box appears.</li> <li>5. Lower the values in "Receive Buffer" and "Transmit Buffer" in the [Advanced Port Settings] dialog box.</li> <li>6. Click the &lt;OK&gt; button to close the dialog boxes displayed.</li> </ol>	

### 3 Upload is disabled

Check Item	Treatment	Manual Ref.
Ensure that the <Upload> button is selectable.	Communicate the computer with MM6-CAL22. Upload is enabled when the computer communicates with MM6-CAL22. Then the <Upload> button will be selectable.	Sec. 1-8-1

**4 Download is disabled**

Check Item	Treatment	Manual Ref.
Ensure that the <Download> button is selectable.	Communicate the computer with MM6-CAL22. Upload is enabled when the computer communicates with MM6-CAL22. Then the <Download> button will be selectable.	Sec.1-8-1

**5 The teaching program saved in MM6-CAL22 cannot be deleted on the Teaching Editing software.**

Check Items	Treatment	Manual Ref.
① Check the communication between the computer and MM6-CAL22.	Simply when the computer communicates with MM6-CAL22, the <CLEAR> button in the [MM6-CAL22] teaching program list in the [Main] window is selectable. Check the Check Items in "2 The computer cannot communicate with MM6-CAL22".	Sec.1-8-1
② Ensure that the teaching program to be deleted is being selected.	Double-click the mouse on the number of the teaching program to be deleted in [MM6-CAL22] teaching program list in the [Main] window. Then select the <CLEAR> button.	Sec.3-3-2

**6 Backup is disabled**

Check Items	Treatment	Manual Ref.
① Ensure that the "Setup" in the [File] menu is selectable.	Communicate the computer with MM6-CAL22. Backup is enabled when the computer communicates with MM6-CAL22. Then the "Backup" in the [File] menu will be selectable.	Sec.1-8-1
② Check the access right in the backup destination directory.	To enable the backup, the access right in the backup destination directory is required. Change the backup destination directory or set the access right.	

**7 The comment cannot be entered/modified in the teaching program saved on the computer.**

Check Items	Treatment	Manual Ref.
① Double-click the comment to be entered/modified in the [REMOTE SYSTEM] teaching program list in the [Main] window.	To enter/modify the comment, double-clicking the mouse on the comment is required. Double-click the mouse on the comment to enter or modify the comment.	Sec.2-3-2-6
② Check the rate of double-clicking.	To enter/modify the comment, double-clicking the mouse on the comment is required. If the appropriate double-clicking rate has not been set, the comment cannot be selected. Click the [Start] menu to select the [Set]-[Control Panel]-[Mouse], then set the appropriate double-clicking rate.	

**8 The [Edit] window cannot be opened**

Check Items	Treatment	Manual Ref.
① Double-click the mouse on the number of the teaching program to be edited in the [REMOTE SYSTEM] teaching program list in the [Main] window, not on the comment.	To open the [Edit] window, double-click the number of the teaching program in the [REMOTE SYSTEM] teaching program list. Double-clicking the comment enables the comment to be entered or modified.	Sec.3-3-3
② Check the rate of double-clicking.	To open the [Edit] window, double-clicking the number of the teaching program in the [REMOTE SYSTEM] teaching program list is required. If the appropriate double-clicking rate has not been set, the number cannot be selected. Click the [Start] menu to select the [Set]-[Control Panel]-[Mouse], then set the appropriate double-clicking rate.	





**9 The teaching program cannot be newly created**

Check Items	Treatment	Manual Ref.
① In the [REMOTE SYSTEM] teaching program list in the [Main] window, double-click the number on the line of the blank columns; Comment, Date, and Size.	The number whose columns of Comment, Date, and Size are filled with letters or numbers already has a teaching program. Double-clicking the number with filled columns enables editing the teaching program. To newly create the teaching program, select the number with the entirely blank columns of Comment, Data, and Size.	Sec.2-3-2-3
② Check the rate of double-clicking.	To newly create the teaching program, double-clicking the number with the entirely blank columns in the [REMOTE SYSTEM] teaching program list is required. If the appropriate double-clicking rate has not been set, the number cannot be selected. Click the [Start] menu to select the [Set]-[Control Panel]-[Mouse], then set the right double-clicking rate.	

**10 The directory cannot be newly created**

Check Item	Treatment	Manual Ref.
Ensure that the name of directory is enabled.	In the following case, new directory cannot be created. <ul style="list-style-type: none"> <li>· The column of the directory name is blank.</li> <li>· The entered directory name is already exist.</li> <li>· Unusable letters are entered as the directory name.</li> </ul> Keeping these in mind, enter the directory name.	Sec.3-3-1-3

**11 The directory on the network cannot be selected**

Check Item	Treatment	Manual Ref.
Ensure that the directory to be selected on the network is assigned as the network drive.	If the directory is not assigned as the network drive, set the network drive by selecting the "Network drive assignment" in the [Tool] menu with the explorer.	

**12 The <Alignment Items> button cannot be selected**

Check Items	Treatment	Manual Ref.
① Check that the number of the measurement point or input point is "0".	It shows the middle of the measurement. The measurement items cannot be changed during the measurement. In this case, cancel or complete the measurement.	Sec.4-4-7
② Ensure that the CL10,CL11,CL13,or CL16 button is not being pressed.	The CL10,CL11,CL13,and CL16 are the successive measurements. It is impossible to change the items during the successive measurement until the <C> key is pressed. Clear all the data by pressing the <C> key before pressing the <ENT> key to complete the successive measurement.	Sec.4-4-7

**13 The <Measurement Items> button cannot be selected**

Check Items	Treatment	Manual Ref.
① Check that the number of the measurement point or input point is "0".	It shows the middle of the measurement. The measurement items cannot be changed during the measurement. In this case, cancel or complete the measurement.	Sec.4-4-7
② Ensure that the CL10,CL11,CL13,or CL16 button is not being pressed.	The CL10,CL11,CL13,and CL16 are the successive measurements. It is impossible to change the items during the successive measurement until the <C> key is pressed. Clear all the data by pressing the <C> key before pressing the <ENT> key to complete the successive measurement.	Sec.4-4-7

**14 The <Input Types> button cannot be selected**

Check Items	Treatment	Manual Ref.
① In the [Teaching program editing situation display] in the [Edit] window, check that the left side value of the number of the measurement point is "0".	It shows the middle of the measurement. When the left side value of the number of the measurement point is "0", the input types can be changed. If the value is other than "0", continuing the measurement or pressing the <C> key to clear all data to cancel the measurement enables the input types to be changed.	Sec.4-4-7
② Ensure that the AL11,CL12,CL13,CL14, CL15 or CL19 button is not being pressed.	AL11,CL12,CL13,CL14,CL15,and CL19 are the items to measure the height. During any of these items is executed, the input type is limited to the one point input and other input types cannot be selected.	

**15 The <Ancillary Functions> button cannot be selected**

Check Item	Treatment	Manual Ref.
	The condition disables the ancillary function. Select the <Ancillary Functions> button once more on the condition that each ancillary function is enabled.	

**16 Modification is disabled**

Check Items	Treatment	Manual Ref.
① Ensure that the item can be modified.	The items can be modified are limited to AL7,AL9,AL13, CL17,CL18,and the ancillary functions. Other than these items cannot be modified. Delete the item with the delete function (See sec. APPENDIX B-1) and insert new item.	
② Double-click the mouse on the program in the [Program list display] in the [Edit] window.	To modify the item, double-click the item in the [Program list display]. However some items cannot be modified.	

**17 Copying is disabled**

Check Item	Treatment	Manual Ref.
Ensure that the area to be copied is selected in the [Program list display] in the [Edit] window.	It is required to select the lines to be copied in the [Program list display]. Select the lines to be copied and execute copying once more.	APPENDIX B-2

**18 Pasting is disabled**

Check Items	Treatment	Manual Ref.
① Ensure that the area to be pasted is copied.	The pasting function requires the area being copied in advance. Copy the lines to be pasted before executing pasting.	APPENDIX B-3
② Ensure that the pasting destination is defined.	Pasting is disabled unless the area to be pasted is defined. Confirm the pasting destination in the [Program list display] and click the mouse on the head of the line next to the pasting destination. Then execute pasting.	APPENDIX B-3

## APPENDIX D Troubleshooting Guide

### **19 Deleting is disabled**

---

Check Item	Treatment	Manual Ref.
Ensure that the area to be deleted is defined.	Define the area to be deleted. In the [Program list display], select the area to be deleted and execute deleting.	APPENDIX B-1

### **20 Returning to the initial settings is disabled**

---

Check Item	Treatment	Manual Ref.
Check that any of the alignments, measurements, or ancillary functions is being executed.	If any of measurement is being executed, this function is disabled. To cancel the measurement being executed, click the <C> button to clear all the data.	

### **21 To move the teaching program file to another directory**

---

Check Item	Treatment	Manual Ref.
	The function to copy/delete the teaching program file between the directories is not equipped to the Teaching Editing software. Use the explorer or other methods to directly copy/move the file. Be careful not to lose the data while coping/moving the file.	



# **OLYMPUS®**

---

**OLYMPUS CORPORATION**

Shinjuku Monolith, 3-1, Nishi Shinjuku 2-chome, Shinjuku-ku, Tokyo, Japan

**OLYMPUS EUROPA HOLDING GMBH**

Wendenstrasse 14-18, 20097 Hamburg, Germany

**OLYMPUS AMERICA INC.**

3500 Corporate Parkway, Center Valley, Pennsylvania 18034-0610, U.S.A.

**OLYMPUS AUSTRALIA PTY. LTD.**

31 Gilby Road, Mount Waverley, VIC., 3149, Melbourne, Australia

**OLYMPUS LATIN AMERICA, INC.**

5301 Blue Lagoon Drive, Suite 290 Miami, FL 33126, U.S.A.

