

# INSTRUCTIONS

---

# SZ2-ILST

## LED ILLUMINATOR STAND

Optical Microscope Accessory

This instruction manual is for the Evident SZ2-ILST LED Illuminator Stand. To ensure the safety, obtain optimum performance and to familiarize yourself fully with the use of this equipment, we recommend that you study this manual thoroughly before operating the system. Retain this instruction manual in an easily accessible place near the work desk for future reference.

This product is applied with the requirements of standard IEC/EN61326-1 concerning electromagnetic compatibility.

- Immunity Industrial and basic electromagnetic environment

Emissions exceeding the level required by aforementioned standards may occur if this product is electrically connected to other equipment.



In accordance with European Directive on Waste Electrical and Electronic Equipment, this symbol indicates that the product must not be disposed of as unsorted municipal waste, but should be collected separately.

Refer to your local Evident distributor in EU for return and/or collection systems available in your country.

**NOTE:** This product has been tested and found to comply with the limits for a Class A digital device, pursuant to Part 15 of the FCC Rules. These limits are designed to provide reasonable protection against harmful interference when the product is operated in a commercial environment. This product generates, uses, and can radiate radio frequency energy and, if not installed and used in accordance with the instruction manual, may cause harmful interference to radio communications.

Operation of this product in a residential area is likely to cause harmful interference in which case the user will be required to correct the interference at his own expense.

**FCC WARNING:** Changes or modifications not expressly approved by the party responsible for compliance could void the user's authority to operate the product.

#### **For Korea only**

B급 기기 (가정용 방송통신기자재)

이 기기는 가정용(B급) 전자파적합기기로서 주로 가정에서 사용하는 것을 목적으로 하며, 모든 지역에서 사용할 수 있습니다.

**CONTENTS**

**IMPORTANT** – Be sure to read this chapter for safe use of the equipment. – 1-2

**1 NOMENCLATURE** 3

**2 ASSEMBLY** 4

**3 OPERATION** 5

**1** Lighting the Illuminator and Adjusting the Light Intensity ..... 5

**2** Adjusting the Reflected (Oblique) Illumination Angle ..... 5

**3** Adjusting the Focus Adjustment Knob Tension ..... 5

**4 SPECIFICATIONS** 6

**■ PROPER SELECTION OF THE POWER SUPPLY CORD** ..... 7-8

# IMPORTANT

This manual pertains only to the operation of the LED illuminator stand. Please also read the instruction manuals for the SZ2 series or applicable microscope to understand the comprehensive operating instructions of the microscope system.



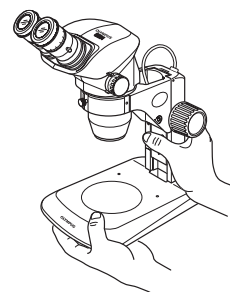

## SAFETY PRECAUTIONS

- After the equipment has been used in an observation of a specimen that is accompanied with a potential of infection, clean the parts coming in contact with the specimen to prevent infection.
  - Moving this product is accompanied with the risk of dropping the specimen. Be sure to remove the specimen before moving this product.
  - In case the specimen is damaged by erroneous operation, promptly take the infection prevention measures.
  - The product becomes unstable if its height is increased by an accessory mounted on it. In this case, take anti-toppling measures to prevent the specimen from being dropped when the product topples down.
- When moving the microscope, hold the bottom of the base with one hand and the pillar with the other hand, and carry the microscope without tilting it.
  - Before carrying, remove the stage glass so that it will not drop during carrying. Also remove other modules from the microscope as they may increase the weight and increases danger.
- LED (Light Emitting Diode) device is included in this product.
  - Do not stare at the LED illumination (particularly the reflected illumination) light directly, as this may damage your eye.
  - When a mirror or similar element is engaged in the illumination light path, take special care against the reflected light that may enter your eye.
  - Use of controls or adjustments performance of procedures other than those specified herein may result in hazardous radiation exposure.
- Always use the power cord provided by Evident. If no power cord is provided, please select the proper power cord by referring to the section "PROPER SELECTION OF THE POWER SUPPLY CORD" at the end of this instruction manual. If the proper power cord is not used, product safety performance cannot be warranted.
- Always ensure that the **grounding terminals** are properly connected. If the equipment is not grounded, Evident can no longer warrant the electrical safety performance of the equipment.
- If water or a liquid is spilt on the top of the LED illuminator stand, treat it quickly and properly as described in "**2 Maintenance and Storage**" below.



### Safety Symbols

The following symbols are found on the equipment. Study the meaning of the symbols and always use the equipment in the safest possible manner.

Symbol	Explanation
	Before use, carefully read the instruction manual. Improper use could result in personal injury to the user and/or damage to the equipment.
	Indicates the transmitted light illumination.
	Indicates the reflected light illumination.
	Indicates that the main switch is ON.
	Indicates that the main switch is OFF.

## 1 Getting Ready

1. The LED illuminator stand is a precision instrument. Handle it with care and avoid subjecting it to sudden or severe impact.
2. Do not use the LED illuminator stand where it is subjected to direct sunlight, high temperature and humidity, dust or vibrations. (For the operating conditions, refer to chapter 4, "SPECIFICATIONS" on page 6.)
3. The LED illuminator stand can be used with the following microscope bodies.
  - SZ2 series microscopes (SZ51, SZ51-60, SZ61, SZ61-60 or SZ61TR) and SZX7
  - Previous SZ series microscopes
4. Install the LED illuminator stand on a desktop surface that is as level as less than 3° from the horizontal plane, and the mounted load should be less than 7 kilograms.
5. This equipment is not provided with the ESD (electro static discharge) compatibility.
6. The illumination performance cannot be manifested fully if an optional low-power auxiliary objective (SZ2 series) or objective (SZX7) is used. (For details, see page 5.)
7. Light intensity does not change linearly with respect to the rotation of the light intensity knob.
8. The color hues may be variable depending on the variance of each LED.
9. The following modules cannot be mounted on this equipment.
  - Stage plate
  - Stage or stage adapter
  - Oblique illuminator LSGA
  - Coaxial reflected light illuminator SZ2-ILLC

## 2 Maintenance and Storage

1. To clean the lenses and other glass components, simply blow dirty away using a commercially available blower and wipe gently using a piece of cleaning paper (or clean gauze).  
If a lens is stained with fingerprints or oil smudges, wipe it gauze slightly moistened with commercially available absolute alcohol.
  - ▲ **Since the absolute alcohol is highly flammable, it must be handled carefully.**  
Be sure to keep it away from open flames or potential sources of electrical sparks — for example, electrical equipment that is being switched on or off.  
Also remember to always use it only in a well-ventilated room.
2. Do not attempt to use organic solvents to clean the parts other than the glass components. To clean them, use a lint-free, soft cloth slightly moistened with a diluted neutral detergent.
3. The stage surface is provided with a simplified waterproof construction. If water is spilt on it, promptly set the main switch to "O" (OFF), unplug the power cord and wipe with a dry cloth.
  - ▲ **If water penetrates inside the equipment, contact Evident to have the electrical safety checked.**
4. Do not disassemble any part of the equipment as this could result in malfunction or reduced performance.

## 3 Caution

If the LED illuminator stand is used in a manner not specified by this manual, the safety of the user may be imperiled. In addition, the equipment may also be damaged. Always use the equipment as outlined in this instruction manual.

The following symbols are used to set off text in this instruction manual.

- ▲ : Indicates that failure to follow the instructions in the warning could result in bodily harm to the user and/or damage to equipment (including objects in the vicinity of the equipment).
- ★ : Indicates that failure to follow the instructions could result in damage to equipment.
- ◎ : Indicates commentary (for ease of operation and maintenance).

## 4 Intended use

This instrument has been designed to be used to observe magnified images of specimens in routine and research applications.

Do not use this instrument for any purpose other than its intended use.

# 1 NOMENCLATURE

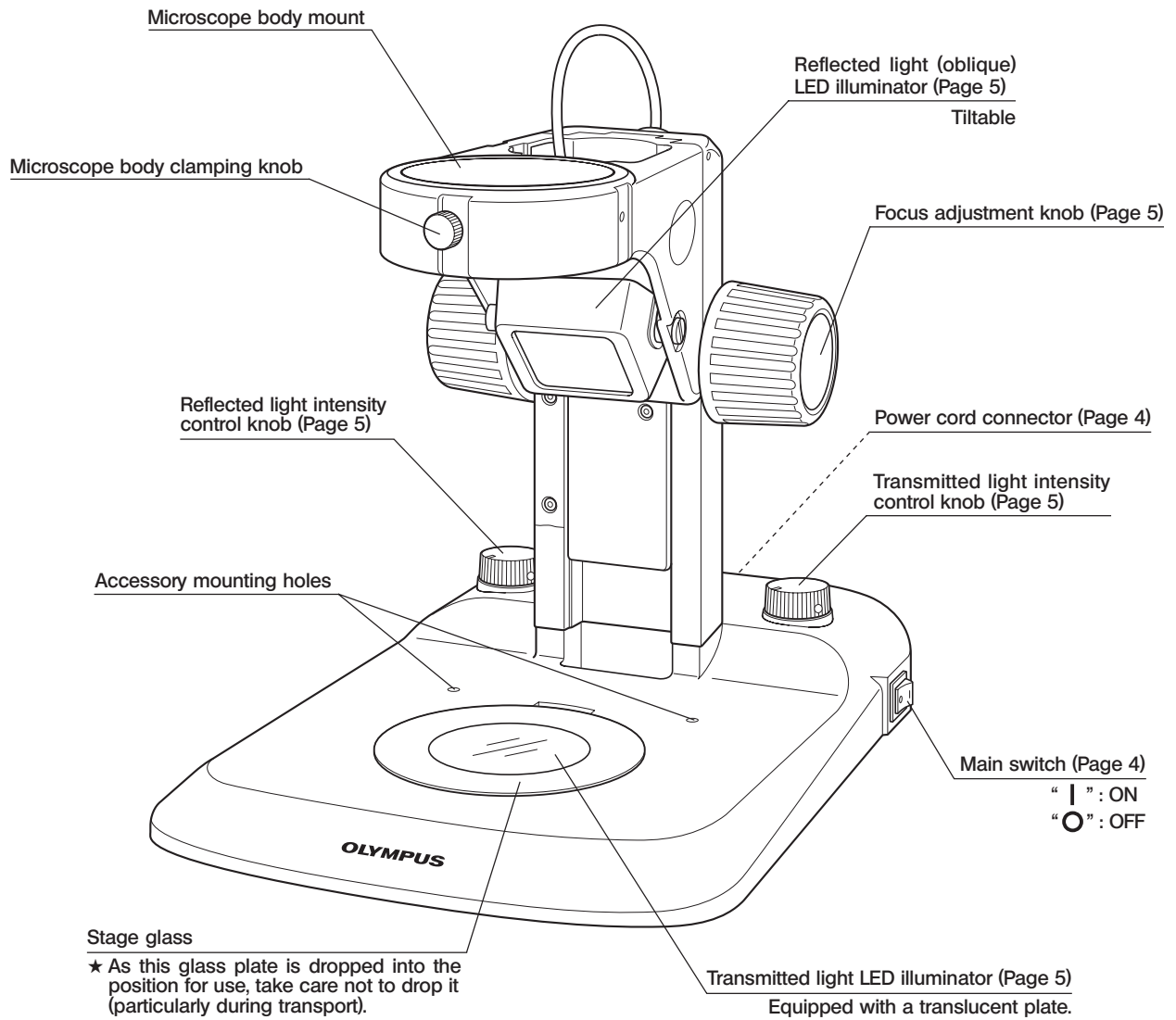

# 2 ASSEMBLY

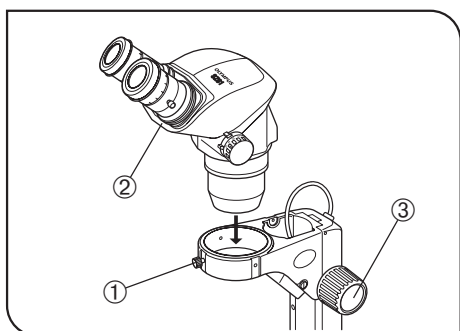

Fig. 1

## 1 Mounting the Microscope Body (Fig. 1)

1. Loosen the microscope body clamping knob ①.
2. Gently insert an applicable microscope body ② and tighten the clamping knob.

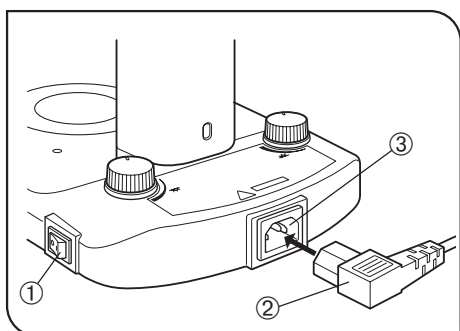

Fig. 2

## 2 Setting Up the Power Supply (Figs. 2 & 3)

- ▲ Cables and cords are vulnerable when bent or twisted. Never subject them to excessive force.
- ▲ Make sure that the main switch ① is set to “O” (OFF) before connecting the power cord.
- ▲ Always use the power cord provided by Evident. If no power cord is provided, please select the proper power cord by referring to the section “PROPER SELECTION OF THE POWER SUPPLY CORD” at the end of this instruction manual.

1. Connect the connector ③ of the power cord to the power cord ② firmly.
- ▲ Be sure to supply power from a grounded, 3-conductor power outlet using the proper power cord. If the power outlet is not grounded properly, Evident can no longer warrant the electrical safety performance of the equipment.
2. Connect the plug ④ of the power cord to the wall outlet ⑤.

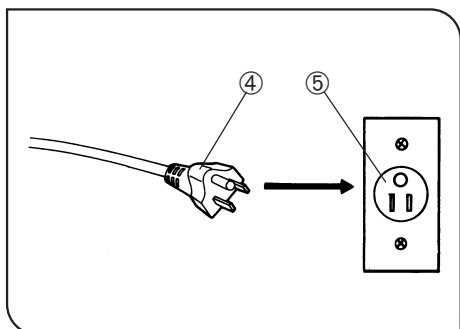

Fig. 3

# 3 OPERATION

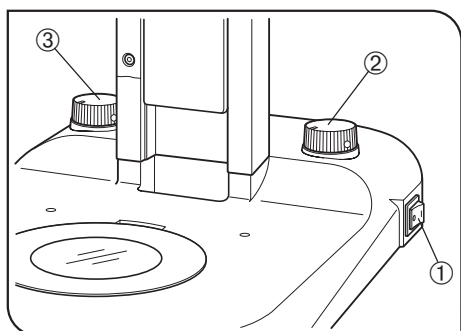

Fig. 4

## 1 Lighting the Illuminator and Adjusting the Light Intensity (Fig. 4)

1. Press the "I" (ON) segment of the main switch ① to turn on the LED illuminator.  
The LED illuminator can be used in both transmitted and reflected light illumination.
2. Turn the transmitted light intensity control knob ② and reflected light intensity control knob ③ clockwise to increase the brightness.

### Objectives and illumination performances

#### SZ2 series

Auxiliary objective	Transmitted light	Reflected light
110 AL 0.5X	Zoom 1.5X or more*	Zoom 1.2X or more*
110 AL 0.62X	Zoom 1.2X or more*	
110 AL 0.75X	Zoom 1X or more*	Any magnification available.
—		
110 AL 1.5X		
110 AL 2X		

#### SZ7

Auxiliary objective	Transmitted light	Reflected light
DFPL 0.5X-4	Zoom 1.6X or more*	Zoom 1.25X or more*
DFPL 0.75X-4	Zoom 1.25X or more*	Zoom 1X or more*
DFPLAPO 1X-4	Any magnification available.	
SZX-ACH 1X		
SZX-ACH 1.25X		
DFPL 1.5X-4		Zoom 3.2X or more*
DFPL 2X-4		Not available**

© When the TV light path of the SZ61TR is used with the image pickup CCD size of 2/3 in. or more, the light in the peripheral area may be insufficient.

\* Irregularities in illumination or insufficiency in the peripheral light may occur at lower magnifications than mentioned.

\*\* This is because the illumination is obscured by the objective.

## 2 Adjusting the Reflected (Oblique) Illumination Angle

Hold the oblique light illuminator and adjust its angle so that the illumination light hits the specimen.

## 3 Adjusting the Focus Adjustment Knob Tension

Use the same procedure as the procedure for the standard stand, which is described in the instruction manual for the microscope body.



# 4 SPECIFICATIONS

Item	Specifications
Applicable microscopes	SZ2 series microscopes (SZ51, SZ51-60, SZ61, SZ61-60 or SZ61TR) and SZX7 SZ series microscopes (Previous models)
Focus adjustment	Focusing stroke 120 mm (85 mm up, 35 mm down) Focus adjustment knob tension is adjustable.
Transmitted light illumination	White LED (48 elements) illumination Average LED life: 6000 hours*
Reflected light illumination	White LED (30 elements) illumination Average LED life: 6000 hours*
Dimensions & weight	226(W) x 237(H) x 318(D) mm. approx. 2.6 kg
Input rating	100-120 V/220-240 V ~ , 0.15/0.1 A, 50/60 Hz
Operating environment	<ul style="list-style-type: none"> <li>• Indoor use</li> <li>• Altitude: Max. 2000 m</li> <li>• Ambient temperature: 5°C to 40°C (41°F to 104°F)</li> <li>• Maximum relative humidity: 80% for temperatures up to 31°C (88°F), decreasing linearly through 70% at 34°C (93°F), 60% at 37°C (99°F), to 50% relative humidity at 40°C (104°F)</li> <li>• Supply voltage fluctuations: ±10%</li> <li>• Pollution degree: 2 (in accordance with IEC60664)</li> <li>• Installation (overvoltage) category: II (in accordance with IEC60664)</li> </ul>

\* When the luminance is 50%.

## ■ PROPER SELECTION OF THE POWER SUPPLY CORD

If no power supply cord is provided, please select the proper power supply cord for the equipment by referring to “ Specifications ” and “ Certified Cord ” below:

**CAUTION:** In case you use a non-approved power supply cord for Evident products, Evident can no longer warrant the electrical safety of the equipment.

### Specifications

Voltage Rating	125V AC (for 100-120V AC area) or, 250V AC (for 220-240V AC area)
Current Rating	6A minimum
Temperature Rating	60°C minimum
Length	3.05 m maximum
Fittings Configuration	Grounding type attachment plug cap. Opposite terminates in molded-on IEC configuration appliance coupling.

**Table 1 Certified Cord**

A power supply cord should be certified by one of the agencies listed in Table 1 , or comprised of cordage marked with an agency marking per Table 1 or marked per Table 2. The fittings are to be marked with at least one of agencies listed in Table 1. In case you are unable to buy locally in your country the power supply cord which is approved by one of the agencies mentioned in Table 1, please use replacements approved by any other equivalent and authorized agencies in your country.



















Country	Agency	Certification Mark	Country	Agency	Certification Mark
Argentina	IRAM		Italy	IMQ	
Australia	SAA		Japan	JET, JQA, TÜV, UL-APEX / MITI	
Austria	ÖVE		Netherlands	KEMA	
Belgium	CEBEC		Norway	NEMKO	
Canada	CSA		Spain	AEE	
Denmark	DEMKO		Sweden	SEMKO	
Finland	FEI		Switzerland	SEV	
France	UTE		United Kingdom	ASTA BSI	
Germany	VDE		USA	UL	
Ireland	NSAI				

Table 2 HAR Flexible Cord

APPROVAL ORGANIZATIONS AND CORDAGE HARMONIZATION MARKING METHODS

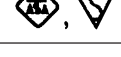
Approval Organization	Printed or Embossed Harmonization Marking (May be located on jacket or insulation of internal wiring)		Alternative Marking Utilizing Black-Red-Yellow Thread (Length of color section in mm)		
			Black	Red	Yellow
Comite Electrotechnique Belge (CEBEC)	CEBEC	⟨HAR⟩	10	30	10
Verband Deutscher Elektrotechniker (VDE) e.V. Prüfstelle	⟨VDE⟩	⟨HAR⟩	30	10	10
Union Technique de l'Electricite' (UTE)	USE	⟨HAR⟩	30	10	30
Instituto Italiano del Marchio di Qualita' (IMQ)	IEMMEQU	⟨HAR⟩	10	30	50
British Approvals Service for Electric Cables (BASEC)	BASEC	⟨HAR⟩	10	10	30
N.V. KEMA	KEMA-KEUR	⟨HAR⟩	10	30	30
SEMKO AB Svenska Elektriska Materielkontrollanstalter	SEMKO	⟨HAR⟩	10	10	50
Österreichischer Verband für Elektrotechnik (ÖVE)	⟨ÖVE⟩	⟨HAR⟩	30	10	50
Danmarks Elektriske Materialkontroll (DEMKO)	⟨DEMKO⟩	⟨HAR⟩	30	10	30
National Standards Authority of Ireland (NSAI)	⟨NSAI⟩	⟨HAR⟩	30	30	50
Norges Elektriske Materielkontroll (NEMKO)	NEMKO	⟨HAR⟩	10	10	70
Asociacion Electrotecnica Y Electronica Espanola (AEE)	⟨UNED⟩	⟨HAR⟩	30	10	70
Hellenic Organization for Standardization (ELOT)	ELOT	⟨HAR⟩	30	30	70
Instituto Portages da Qualidade (IPQ)	np	⟨HAR⟩	10	10	90
Schweizerischer Elektro Technischer Verein (SEV)	SEV	⟨HAR⟩	10	30	90
Elektriska Inspektoratet	SETI	⟨HAR⟩	10	30	90

Underwriters Laboratories Inc. (UL)  
Canadian Standards Association (CSA)

SV, SVT, SJ or SJT, 3 X 18AWG  
SV, SVT, SJ or SJT, 3 X 18AWG

Manufactured by

**Evident Corporation**

6666 Inatomi, Tatsuno-machi, Kamiina-gun, Nagano 399-0495, Japan

Distributed by

**Evident Europe GmbH**

Caffamacherreihe 8-10, 20355 Hamburg, Germany

**Evident Europe GmbH – UK Branch**

Part 2nd Floor Part A, Endeavour House, Coopers End Road, Stansted CM24 1AL, UK

**Evident Scientific, Inc.**

48 Woerd Ave, Waltham, MA 02453, USA

**Evident Scientific Singapore PTE. LTD.**

#04-04/05, 25 Ubi Rd 4, UBIX Singapore 408621

**Evident Australia PTY LTD**

Level 4, 97 Waterloo Road Macquarie Park NSW 2113, Australia

**Life science solutions**

Service Center



<https://www.olympus-lifescience.com/support/service/>

Official website



<https://www.olympus-lifescience.com>

**Industrial solutions**

Service Center



<https://www.olympus-ims.com/service-and-support/service-centers/>

Official website



<https://www.olympus-ims.com>