

OLYMPUS



Instruction manual

OLYMPUS LC35

Digital Microscope Camera

Optical Microscope Accessory

English

Contents

1 Safety	4
1.1 Intended use	4
1.2 Avoiding personal injury and device damage	4
1.3 Explanation of the symbols used	6
2 The OLYMPUS LC35 camera	7
2.1 Scope of supply	7
2.2 System diagram	8
2.3 LED status indication	9
2.4 Specifications	10
2.5 Operating and storage conditions	11
3 System environment	12
3.1 Microscope and camera adapter	12
3.2 Recommended computer and monitor configuration	13
3.3 Restrictions on use	13
4 Assembly	15
4.1 Attaching the camera	15
4.2 Connecting the USB camera cable	16
4.3 Installing the software	17
5 Acquiring images	18
6 Cleaning the camera	19
7 Troubleshooting	20
7.1 Possible problems	20
7.2 Contacting Customer Service	24
8 Declarations of conformity and notes on disposal	25
AdressSticker_08042022	29

About the camera

The OLYMPUS LC35 is a CMOS color camera with a high frame rate. It was developed for acquisitions using light microscopy. The camera can be connected to all common types of light microscopes using a C-mount.

About this instruction manual

This instruction manual is for the OLYMPUS LC35 microscope digital camera.

Information about the operation of the microscope, computer or software can be found in the instruction manuals for the corresponding device or software.

Trademark

Microsoft and Windows are registered trademarks of Microsoft Corporation, USA. All other brand names and product names mentioned in this manual are registered trademarks or trademarks of their respective owners.

1 Safety

The camera has been developed and produced in conformity with recognized safety regulations. However, it is not possible to entirely rule out possible hazards for the user, damage to the camera or microscope, or impairments of the camera's functionality. For this reason, always read and follow the general safety instructions and warnings before and during installation.

1.1 Intended use

This camera is intended to be used for the acquisition of digital images, but not for medical diagnostic purposes.

1.2 Avoiding personal injury and device damage

WARNING - Avoiding personal injury

Electric shock due to damaged cable

When a cable is frayed or damaged, a person touching it risks receiving an electric shock. Shut off the hardware and replace the cable immediately.

Poisoning due to toxic gases

In the event of a fire, the material of the camera can give off toxic gases. When these are inhaled, it can cause irritation or damage to the respiratory tract. Wear respiratory protection when fighting the fire.

 CAUTION - Avoiding personal injury**Tripping hazard**

Cables laid across a room can be a dangerous tripping hazard. This can cause injuries to people and damage to equipment. Wherever possible, lay cables along the wall or behind furniture. Fix and label cables that run across the room.

ATTENTION - Avoiding device damage**Never open the camera**

The camera's CMOS chip is extremely sensitive. Electrostatic discharge can permanently damage the camera. Therefore, never open the camera housing.

Use only the supplied USB camera cable

Operate the camera only with the supplied USB camera cable. Only then will the functionality of the camera and compliance with the EMC basic standards be ensured.

Don't touch the protective glass

The protective glass over the CMOS chip is extremely sensitive and must not come into contact with bare hands or any other objects, otherwise the acquired images will be impaired by fingerprints or scratches.

Avoid vibration shocks

Mechanical shocks and strong vibrations can damage the camera. Don't drop the camera during assembly. Make sure the camera is securely mounted on the microscope. When the camera is not in use, store it in a safe place.

Comply with operating and storage conditions

Exposure to high temperatures or humidity can damage component parts of the camera. Always observe the operating and storage conditions (see page 11).

1.3 Explanation of the symbols used

WARNING

Indicates a potentially hazardous situation which, if not avoided, may result in major injury.

CAUTION

Indicates a potentially hazardous situation which, if not avoided, may result in minor or moderate injury.

ATTENTION

Indicates a situation which, if not avoided, may damage the equipment or other property.

2 The OLYMPUS LC35 camera

2.1 Scope of supply

Camera

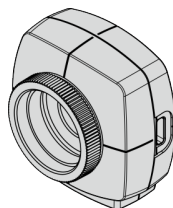

USB camera cable

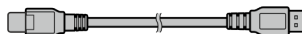

Safety and warning information



A printed copy of the safety and warning information are supplied with the camera.

The complete instruction manual is available for download. You can download the manual from the following web pages

<https://www.olympus-lifescience.com/support/instruction-manual-downloads/>

<https://www.olympus-ims.com/user-manuals/>

2.2 System diagram

To use the OLYMPUS LC35 with a light microscope, you need suitable software and a computer as well as a monitor. For the recommended computer and monitor configuration, refer to page 13.

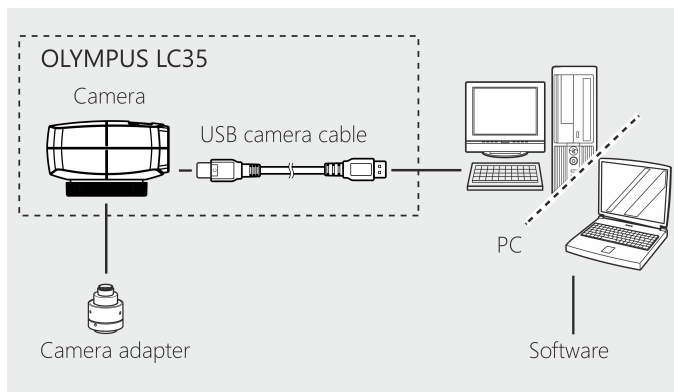

You can use the following Olympus software applications:

Software application		Minimum version
cellSens*	Life science image analysis software	3.2
OLYMPUS Stream*	Image analysis software	2.5

Software application		Minimum version
PRECiV*	Image and measurement software	1.1
DP2-TWAIN**	Free image acquisition software	10.2
LCmicro**	Free image acquisition software	2.3

* Perform the available service updates.

** This software is available only as a download from the following web pages.

<https://www.olympus-lifescience.com/support/downloads>

<https://www.olympus-ims.com/service-and-support/downloads>

2.3 LED status indication

There is an LED on the camera which indicates the following statuses.

LED	Status
The LED flashes green.	The camera is being initialized.
The LED lights up continuously green.	The camera is successfully connected to the USB 3.1 port.
The LED flashes red/orange.	There is a camera error. Contact Customer Service (see page 24).
The LED lights up orange.	The camera is not connected to the USB 3.1 port. If this is the case, you will receive a corresponding error message.

2.4 Specifications

The OLYMPUS LC35 is a CMOS color camera with a high frame rate. It was developed for acquisitions using light microscopy. The camera can be connected to all common types of light microscopes using a C-mount.

Chip type	CMOS color sensor
Chip size	1/2.5 Inch
Recording area	5.702 mm x 4.277 mm 7.13 mm diagonal
Maximum resolution	2160 x 1620 pixels 3.5 million pixels
Camera port of the microscope	C-Mount
Input / output	On the camera: USB 3.1 type C On the computer: USB 3.1 type A

Resolution		Frame rate*	Exposure time
2160 x 1620	Full resolution	19 fps	25 μ s - 1534 ms
1296 x 972	Fast mode	40 fps	
1920 x 1080	Full HD	25 fps	
* The maximum achievable frame rate is listed. The frame rate depends, among other things, on the computer being used.			

2.5 Operating and storage conditions

Always meet the operating and storage conditions.

Operating environment

Ambient temperature	+5 °C - +40°C
Relative humidity	5% - 85% (without condensation)
Altitude	Up to 2000 m

Storage conditions

Ambient temperature	-20°C - +60°C
Relative humidity	10% - 90%

Camera storage

When not using the camera, attach the cover to the C-mount and store the camera in a safe place.

3 System environment

3.1 Microscope and camera adapter

Supported microscopes

Upright microscopes

CX23 / CX33 / CX43 / BX43 / BX46 / BX53/ BX53M

Inverted microscopes

CKX53

Stereo microscopes

SZX7 / SZX10 / SZX16 / SZ61TR

Camera adapter connected to OLYMPUS LC35

U-TV1XC / U-TV1X+U-CMAD3	O
U-TV0.63XC	O
U-TV0.5XC-3	O
U-TV0.35XC-2	(-)*
0.5XC (integrated in SZ61TR)	O

O Compatible

(-)* Limited compatible: Depending on the microscope used, this camera adapter can lead to a point-like brightening in the center of the image and shadowing at the edge of the image

You can find more information in chapter "Restrictions on use" on the facing page.

3.2 Recommended computer and monitor configuration

When you connect the OLYMPUS LC35 to a computer, the following system requirements must be met.

CPU	Intel® Core i5, Intel® Core i7, Intel® Core i9 Intel® Xeon (or equivalent)
CPU cores	Recommendation: 4 or more physical CPU cores
RAM	Recommendation: 8 GB or more (dual channel)
Monitor	Resolution 1920 x 1080 or higher
Communication port	USB 3.1 type A
Removable media drive	Optical drive (double-layer capable)
Computer input device	Recommendation: 3-button mouse with wheel. Keyboard
Operating system	Microsoft® Windows® 10 (64 Bit)

3.3 Restrictions on use

OLYMPUS LC35 With other microscopes

The camera can be used in combination with many available microscopes. However, the performance of the camera can only be guaranteed for the microscopes listed in the "Microscope and camera adapter" chapter on page 12.

The camera's performance in combination with other microscopes has not been tested.

Brightness fluctuations in the camera image

With very high illumination intensities and short exposure times at the same time, the following phenomena can occur:

- Flickering in the image displayed
- Uneven exposure

If possible, reduce the illumination light level or use an attenuation filter to increase the exposure time to 20 ms or longer.

Clouding at the edges of the field of view caused by an intermediate tube that is too long

If the intermediate tube is too long (see following example), clouding can occur at the edges of the field of view.

Examples of an intermediate tube that is too long:

- Two or more intermediate adapters are being used together.
- BX3 series: The vertical illuminator and the intermediate adapter are being used together.

Flare when the aperture stop is small

Spot flare can occur when the aperture stop is closed. This flare can be decreased by opening the aperture stop.

No support of simultaneous image acquisition using several cameras

You can mount several OLYMPUS LC35 cameras to one microscope. However, it isn't possible to simultaneously operate several cameras with one computer.

4 Assembly

4.1 Attaching the camera

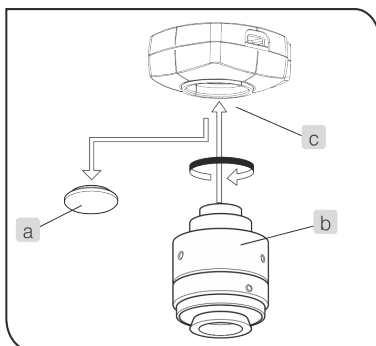

1. Remove the cap of the C-mount port (a).
2. Screw the C-mount camera adapter (b) into the C-mount thread (c) at the bottom of the camera head.
3. Attach the C-mount camera adapter to the camera port of the microscope.

Checking the camera's orientation

If the camera is not attached in the correct orientation, the camera image does not match the image visible through the eyepieces.

1. After attaching the camera, compare the eyepiece image with the live image on the monitor.
2. Rotate the camera adapter so that the alignment of these images matches.

4.2 Connecting the USB camera cable

ATTENTION

Use only the supplied USB camera cable

Operate the camera only with the supplied USB camera cable. Only then will the functionality of the camera and compliance with the EMC basic standards be ensured.

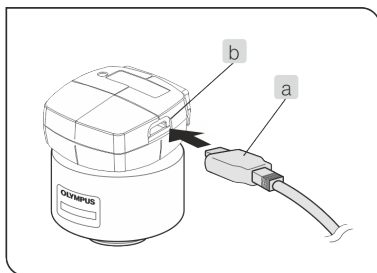

1. Connect the USB type C plug (a) to the camera's USB type C socket (b).

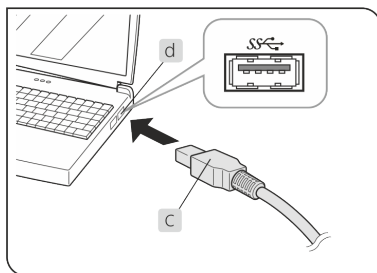

2. Connect the USB camera cable's USB type A plug (c) to the USB 3.1 port (d) of the computer.
Depending on the computer, the USB 3.1 port is either

colored blue or labeled "SS".

The camera can't be operated using a USB 2.0 port.

4.3 Installing the software

cellSens, OLYMPUS Stream, PRECiV

Read the installation manual before installing the software.

TWAIN driver DP2-TWAIN, LCmicro

This software is available only as a download from the Olympus Internet site.

<https://www.olympus-lifescience.com/support/downloads>

<https://www.olympus-ims.com/service-and-support/downloads>

5 Acquiring images

You can find detailed instructions in the instruction manual or in the Help of the software you are using.

Example of the acquisition process

Brightfield observation

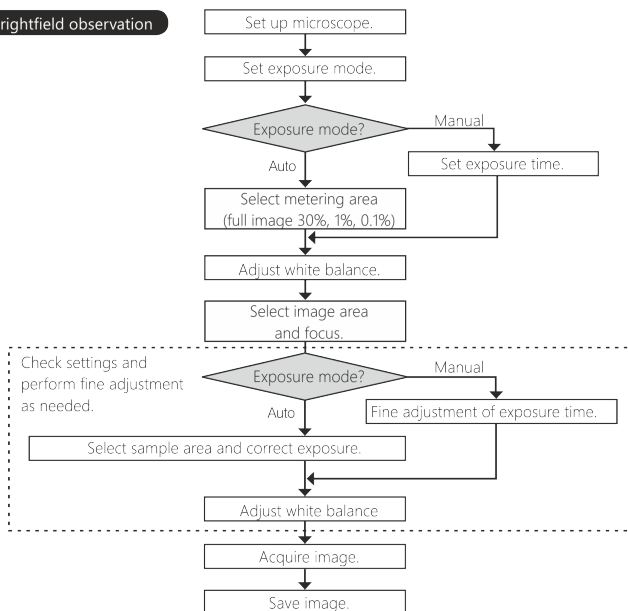

6 Cleaning the camera

When correctly handled, the camera has a long life span and is to a large extent maintenance-free.

Cleaning the protective glass

To clean the camera's protective glass, use a standard rubber air blower to remove the dust and clean it gently with a clean lens cloth. If there are fingerprints or oil smudges on the protective glass, carefully clean it with a clean lens cloth moistened with pure alcohol.

Cleaning the housing

Parts other than the glass components should be cleaned with a clean cloth. Do not use organic solvents to remove major stains. Use a soft cloth moistened with a neutral detergent solution.

	Never open the camera
ATTENTION	The camera's CMOS chip is extremely sensitive. Electrostatic discharge can permanently damage the camera. Therefore, never open the camera housing.

7 Troubleshooting

7.1 Possible problems

Problem: The camera is not working

Possible cause	Remedy
The USB camera cable is not connected properly.	Connect the USB camera cable properly. When the USB camera cable is connected properly, the LED lights up continuously green before the software starts.
The USB camera cable is connected to a USB 2.0 port.	Connect the camera to an USB 3.1 port.

Problem: Live image is not displayed

Possible cause	Remedy
The illumination of the microscope is not turned on.	Switch on the microscope illumination.
The light path selector of the microscope is not set to the camera.	Set the light path selector of the microscope to the camera output.
The illumination intensity of the microscope is not adjusted properly.	Set the illumination intensity of the microscope correctly.
Live image is very dark	Increase the exposure time.

Problem: A snapshot cannot be acquired

Possible cause	Remedy
The software you use to operate your camera (for example, cellSens) performs processing or data storage after the acquisition.	Wait until the processing is finished. Then acquire the next snapshot.
The computer's RAM is fully occupied.	Close other software applications. Then acquire the next snapshot.
There are too many images loaded in your software.	If necessary, save the images. Close the loaded images. Then acquire the next snapshot.

Problem: The image is too bright

Possible cause	Remedy
The exposure compensation is set too high to the + side.	Set the exposure compensation to a more suitable value.
A dark area of the image was mistakenly set as the metering area	Set a more suitable metering area.
The AE lock is set at an exposure time that is too long.	Deactivate the AE lock.
The illumination of the microscope is too bright.	Reduce the illumination light level or use an attenuation filter.
The manual exposure time is too long.	Reduce the manual exposure time.

Problem: The image is too dark

Possible cause	Remedy
Exposure compensation is set too low to the - side.	Set the exposure compensation to a more suitable value.
A bright area of the image was mistakenly set as the metering area	Set a more suitable metering area.
The AE lock is set at an exposure time that is too short.	Deactivate the AE lock.
The illumination of the microscope is too dark.	Increase the illumination light level using the brightness control or remove attenuation filters.
The manual exposure time is set too low.	Increase the manual exposure time.

Problem: The colors of the image are inaccurate

Possible cause	Remedy
The reference area for white balance was not selected appropriately.	Set a reference area for white balance in which nothing can be seen in the background.
The screen color of the computer is not set correctly.	Set the screen color of the computer to 24 bit or higher. 32 bit is recommended.
The color space was not selected appropriately.	Change the camera settings in your software. Select the appropriate color adjustment which is suitable for your microscope, observation method and samples.

Problem: The acquired image is not in focus

Possible cause	Remedy
The microscope was not focused on the sample.	Focus the microscope on the sample.
The parfocality between the camera adapter and the eyepieces is not adjusted properly.	Adjust the parfocality between the camera adapter and the eyepieces properly.
The aperture diaphragm of the condenser is too wide open.	Set the aperture diaphragm to 75% of the objective's numerical aperture and focus the microscope on the sample.
The field diaphragm is too wide open.	Narrow the field aperture appropriately and focus the microscope on the sample.
Lens components of the microscope and the cover glass on the bottom of the camera are dirty.	Clean the objective, the condenser, the window lens of the microscope, and the cover glass on the bottom of the camera (see page 19).
The microscope and camera are being subjected to vibration during acquisition.	Acquire images in an environment where the microscope and camera are not subjected to vibration. It is effective to use an anti-vibration table.

7.2 Contacting Customer Service

Please contact your local Olympus support if you have any questions about the product. More information can be found on this website:

<https://www.olympus-lifescience.com/support/service/>



<https://www.olympus-ims.com/de/service-and-support/service-centers/>



8 Declarations of conformity and notes on disposal

EMV Conformity (Europe)

This product complies with the requirements of Directive 2014/30/EU concerning electromagnetic compatibility according to Standard IEC/EN61326-1.

- Emission: Class B
- Immunity: Suitable for residential and industrial environments.

WEEE declaration (Europe)



In accordance with the European directive on Waste of Electrical and Electronic Equipment, this symbol indicates that the product must not be disposed of as unsorted municipal waste but should be collected separately. Refer to your local authority in the EU for return and/or collection systems available in your country.

RoHS conformity (Europe)

This Olympus Soft Imaging Solutions camera conforms with the European Union directive on the restriction of the use of certain hazardous substances in electrical and electronic equipment 2011/65/EU.

FCC conformity (USA)

This device complies with part 15 of the FCC Rules. Operation is subject to the following conditions: (1) this device may not cause harmful interference, and (2) this device must accept any interference received, including interference that may cause undesired operation.

This device has been tested and found to comply with the limits for a Class B digital device, pursuant to Part 15 of the FCC Rules.

These limits are designed to provide reasonable protection against harmful interference in a residential installation. This device generates, uses, and can radiate radio frequency energy. If not installed and used in accordance with the instructions, it may cause harmful interference to radio communications.

However, there is no guarantee that interference will not occur in a particular installation.

If this equipment does cause harmful interference to radio or television reception, which can be determined by turning the equipment off and on, the user is encouraged to try to correct the interference by one or more of the following measures:

1. Reorient or relocate the receiving antenna
2. Increase the distance between the equipment and receiver
3. Connect the equipment into an outlet on a circuit different from that to which the receiver is connected
4. Consult the dealer or an experienced radio/TV technician for help

FCC warning

Changes or modifications not expressly approved by the party responsible for compliance could void user's authority to operate the equipment.

FCC Supplier's Declaration of Conformity

The supplier hereby declares that the product

Product name: Optical Microscope Accessory

Model Number: OLYMPUS LC35

Conforms to the following specifications:

FCC Part 15, Subpart B, Section 15.107 and Section 15.109

Supplementary Information:

This device complies with part 15 of the FCC Rules. Operation is subject to the following two conditions: (1) This device may not cause harmful interference, and (2) this device must accept any interference received, including interference that may cause undesired operation.

Responsible Party Name: Olympus Scientific Solutions Americas Corp.

Address: 48 Woerd Ave Waltham, MA 02453, U.S.A.

Phone Number: 781-419-3900

Korea

이 기기는 업무용 환경에서 사용할 목적으로 적합성평가를 받은 기기로서 가정용 환경에서 사용하는 경우 전파간섭의 우려가 있습니다.

Trade Name or Registrant:	Olympus Soft Imaging Solutions GmbH
Equipment Name:	Optical Microscope Accessory
Basic Model Number:	OLYMPUS LC35
Registration No.:	R-R-OIS-70000000
Manufacturer/ Country of Origin:	Olympus Soft Imaging Solutions GmbH, Germany

China RoHS conformity (China)



电器电子产品有害物质限制使用标志

本标志是根据“电器电子产品有害物质限制使用管理办法”以及“电子电气产品有害物质限制使用标识要求”的规定，适用于在中国销售的电器电子产品上的电器电子产品有害物质使用限制标志。
 (注意) 电器电子产品有害物质限制使用标志内的数字为在正常的使用条件下有害物质等不泄漏的期限，不是保证产品功能性能的期间。

产品中有害物质的名称及含量

部件名称		有害物质					
		铅及其化合物 (Pb)	汞及其化合物 (Hg)	镉及其化合物 (Cd)	六价铬及其化合物 (Cr(VI))	多溴联苯 (PBB)	多溴二苯醚 (PBDE)
主体	机构部件	X	○	○	○	○	○
	光学部件	X	○	○	○	○	○
	电气部件	X	○	○	○	○	○
附件		○	○	○	○	○	○

本表格依据SJ/T 11364的规定编制。
 ○：表示该有害物质在该部件所有均质材料中的含量均在GB/T26572规定的限量要求以下。
 X：表示该有害物质至少在该部件的某一均质材料中的含量超出GB/T26572规定的限量要求。

————— Manufacturer / 製造元 / 制造商 —————

OLYMPUS SOFT IMAGING SOLUTIONS GmbH

Johann-Krane-Weg 39, 48149 Münster, Germany

————— Distributor / 販売代理店 / 经销商* —————

Evident Europe GmbH

Caffamacherreihe 8, 20355 Hamburg, Germany

Olympus Scientific Solutions America Corp.

48 Woerd Ave Waltham, MA 02453, U.S.A.

株式会社エビデント

〒163-0910 東京都新宿区西新宿2-3-1 新宿モノリス
エビデントお客様相談センター, 電話番号：0120-58-0414

仪景通光学科技（上海）有限公司

总部：上海市 自由贸易试验区 日樱北路199-9 号102 及302 部位
售后服务热线：400-969-0456

Evident Korea Co. Ltd.

Seocho-dong, Seocho Central IPARK 5th, 6th Floor, 36, Banpo-daero 18-gil,
Seocho-gu, Seoul

Evident Scientific Singapore Pte. Ltd.

438B Alexandra Road, #03-07/12, Alexandra Technopark Block B, Lobby 3,
Singapore 119968

Evident Scientific Private Ltd.

Unitech Cyber Park 2nd floor, Tower C, Unitech Cyber Park, Sector 39, Gurgaon,
India

Evident Australia Pty Ltd.

Level 4, 97 Waterloo Road, Macquarie Park, NSW 2113, Australia

* The product might not be available in all countries and via all distributors listed here.
本製品は、ここに記載されている国や販売店では入手できない場合があります。
该产品可能不会在所有国家和通过这里列出的所有分销商提供。