



BondMaster 600 Composite Bond Tester

User's Manual

DMTA-10045-01EN — Rev. G
September 2022

This instruction manual contains essential information on how to use this Evident product safely and effectively. Before using this product, thoroughly review this instruction manual. Use the product as instructed. Keep this instruction manual in a safe, accessible location.

EVIDENT SCIENTIFIC INC., 48 Woerd Avenue, Waltham, MA 02453, USA

Copyright © 2022 by Evident. All rights reserved. No part of this publication may be reproduced, translated, or distributed without the express written permission of Evident.

This document was prepared with particular attention to usage to ensure the accuracy of the information contained therein, and corresponds to the version of the product manufactured prior to the date appearing on the title page. There could, however, be some differences between the manual and the product if the product was modified thereafter.

The information contained in this document is subject to change without notice.

Part number: DMTA-10045-01EN

Rev. G

September 2022

Printed in the United States of America

SD, miniSD, and microSD Logos are trademarks of SD-3C, LLC.

All brands are trademarks or registered trademarks of their respective owners and third party entities.

Table of Contents

List of Abbreviations	9
Important Information – Please Read Before Use	11
Intended Use	11
Instruction Manual	11
Device Compatibility	12
Repair and Modification	12
Safety Symbols	12
Safety Signal Words	13
Note Signal Words	14
Safety	14
Warnings	14
Battery Precautions	15
Regulations for Shipping Products with Lithium-Ion Batteries	17
Equipment Disposal	17
BC (Battery Charger - California, USA Community)	17
CE (European Community)	18
UKCA (United Kingdom)	18
RCM (Australia)	18
WEEE Directive	18
China RoHS	19
Korea Communications Commission (KCC)	20
EMC Directive Compliance	20
FCC (USA) Compliance	21
ICES-001 (Canada) Compliance	22
Warranty Information	22
Technical Support	23

Introduction	25
1. Package Contents	27
1.1 Unpacking	27
1.2 Initial Inspection	27
1.3 Contents of the Case	28
2. Overview of the BondMaster 600	31
2.1 Operating Principle and Test Techniques	31
2.2 Connectors	33
2.3 Power Requirements	36
2.3.1 Charger/Adaptor	37
2.3.2 Battery Compartment	40
2.3.3 Lithium-Ion Battery	42
2.3.4 Alkaline Batteries	43
2.4 MicroSD Card Installation	44
2.5 BondMaster 600 Hardware Features	45
2.5.1 Hardware Overview	46
2.5.1.1 Front Panel and SmartKnob	47
2.5.1.2 Keypad	48
2.5.2 Connectors	53
2.5.2.1 PROBE Connector	53
2.5.2.2 Input/Output and VGA OUT Connectors	54
2.5.2.3 MicroSD and USB Port	55
2.5.3 Various Hardware Features	56
2.5.3.1 BondMaster 600 Stand	57
2.5.3.2 O-Ring Gasket and Membrane Seals	57
2.5.3.3 Display Protection	58
2.5.4 Environmental Ratings	58
3. Software User Interface	59
3.1 Starting Up the BondMaster 600	59
3.1.1 Navigating the Application Menu	61
3.1.2 Main Inspection Screen	61
3.2 Selecting from the Menus	63
3.3 Displaying All Parameters Simultaneously – ALL SETTINGS Menu	64
3.3.1 Using the ALL SETTINGS Menu	65
3.3.2 Special Functions in the ALL SETTINGS Menu	65
3.4 Displaying Real-Time Readings	66
3.4.1 Enabling Real-Time Readings on the Main Inspection Screen	67
3.4.2 Enabling Real-Time Readings in Full-Screen Mode – FULL NEXT Key	68

4. Initial Setup	71
4.1 Setting the User Interface Language and Decimal Symbol	71
4.2 Setting the Clock	72
4.3 Changing the Display Settings	73
4.4 Changing the Display Brightness	73
4.5 Adjusting Auto Erase	74
4.6 Selecting the Startup Screen	75
4.7 Activating the Crosshairs	75
5. Control Functions	77
5.1 PowerLink	77
5.2 BondMaster 600 Controls	78
5.2.1 Display	78
5.2.2 Power and Lock Buttons	79
5.2.3 Function Keys	79
5.2.4 Menu Keys	79
5.2.5 SmartKnob	80
5.2.6 Hidden Function — Screen Capture	80
5.3 Modes and Menus	81
5.3.1 PC RF Mode — MAIN Menu	81
5.3.2 PC Swept Mode — MAIN Menu	86
5.3.3 MIA Mode — MAIN Menu	89
5.3.4 RESON Mode — MAIN Menu	91
5.3.5 PC RF Mode — DISP/DOTS Menu	92
5.3.6 PC Swept Mode — DISP/DOTS Menu	98
5.3.7 MIA Mode — DISP/DOTS Menu	99
5.3.8 RESON Mode — DISP/DOTS Menu	100
5.3.9 PC RF Mode — ALARM Menu in RF RUN	101
5.3.10 PC RF Mode — ALARM Menu in RF+XY and XY RUN	104
5.3.11 PC RF Mode — ALARM Menu in XY-SCAN and XY RUN	104
5.3.12 PC Swept Mode — ALARM Menu	104
5.3.12.1 Changing BOX Alarm Parameters in PC Swept Mode	107
5.3.12.2 Changing SECTOR Alarm Parameters in PC Swept Mode	108
5.3.12.3 Changing CIRCLE Alarm Parameters in PC Swept Mode	109
5.3.12.4 Changing Spectrum Alarm Parameters in PC Swept Mode	110
5.3.13 MIA Mode — Alarm Menu	111
5.3.14 RESON Mode — Alarm Menu	113
5.3.15 MEM Menu	114
5.3.16 Memory Text Editor	117
5.3.17 Advanced Setup Menu — ADV SETUP Menu Key	120

6. Applications	129
6.1 Common BondMaster 600 Applications	130
6.1.1 Detecting Skin-to-Core Disbonds in Honeycomb Composite – Flat or Constant Geometry Using PC RF or IMPULSE Techniques	130
6.1.2 Detecting Skin-to-Core Disbonds in Honeycomb Composite – Tapered or Varying Geometry Using PC Swept Technique	141
6.1.3 Detecting Smaller Disbonds in Honeycomb Composite – Mechanical Impedance Analysis (MIA) Technique	145
6.1.4 Detecting Repaired Areas (Potting) in Honeycomb Composite – Mechanical Impedance Analysis (MIA) Technique	150
6.1.5 Inspecting Metal-to-Metal Bonds – Resonance Technique	155
6.1.6 Detecting Interply Delamination in Composites – General Procedure Using Resonance Technique	161
6.2 Advanced Guide for OEM Procedure and Application Development Using the BondMaster 600	168
6.2.1 Analyzing Frequency Response in Honeycomb Composite – Selecting the Best Inspection Frequency Using PC Swept Technique	168
6.2.2 Finding the Best Frequency to Inspect Honeycomb Composite – Mechanical Impedance Analysis (MIA) Technique	174
7. BondMaster PC Software	181
7.1 USB Communication	181
7.2 Screen Capture Using BondMaster PC	181
7.3 Instrument Software Upgrade	183
7.4 PDF Creation	186
7.5 Commands	188
7.6 Remote Control	202
7.7 File Manager	204
7.8 Unlock Options	208
7.9 Backup	209
7.10 Restore	211
8. Maintenance and Troubleshooting	215
8.1 Lithium-Ion Battery	215
8.2 Probe Care and Diagnostics	216

Appendix A: Specifications 217

- A.1 General and Environmental Specifications 217
- A.2 Input/Output Specifications 219
- A.3 Bond Testing Specifications 221
- A.4 Pitch-Catch Tone Burst and Swept Mode Specifications 222
- A.5 Mechanical Impedance Analysis and Resonance Mode Specifications 224
- A.6 Alarms, Connectivity, and Memory Specifications 225
- A.7 Interface Specifications 226

Appendix B: Accessories, Replacement Parts, and Upgrades 229

List of Figures 233

List of Tables 239

List of Abbreviations

AC	alternating current
CD-ROM	compact disc read-only memory
DC	direct current
EFUP	environment-friendly use period
GB	gigabyte
I/O	input-output
ID	identification
IP	ingress protection
LCD	liquid crystal display
LED	light-emitting diode
MIA	mechanical impedance analysis
N/A	not applicable
OEM	original equipment manufacturer
PC	personal computer
PC	pitch-catch
SD	secure digital (card)
SPC	statistical process control
USB	universal serial bus
VAC	volts alternating current
VGA	video graphics array

Important Information — Please Read Before Use

Intended Use

The BondMaster 600 is designed to perform nondestructive inspections on industrial and commercial materials.



WARNING

Do not use the BondMaster 600 for any purpose other than its intended use. It must never be used to inspect or examine human or animal body parts.

Instruction Manual

This instruction manual contains essential information on how to use this product safely and effectively. Before using this product, thoroughly review this instruction manual. Use the product as instructed. Keep this instruction manual in a safe, accessible location.

IMPORTANT

Some of the details of components illustrated in this manual may differ from the components installed on your device. However, the operating principles remain the same.

Device Compatibility

Only use this device with the approved ancillary equipment provided by Evident. Equipment provided by Evident and approved for use with this device is described later in this manual.



CAUTION

Always use equipment and accessories that meet Evident specifications. Using incompatible equipment could cause equipment malfunction and/or damage, or human injury.

Repair and Modification

This device does not contain any user-serviceable parts. Opening the device might void the warranty.



CAUTION

In order to prevent human injury and/or equipment damage, do not disassemble, modify, or attempt to repair the device.

Safety Symbols

The following safety symbols might appear on the device and in the instruction manual:



General warning symbol

This symbol is used to alert the user to potential hazards. All safety messages that follow this symbol shall be obeyed to avoid possible harm or material damage.



High voltage warning symbol

This symbol is used to alert the user to potential electric shock hazards greater than 1000 volts. All safety messages that follow this symbol shall be obeyed to avoid possible harm.

Safety Signal Words

The following safety symbols might appear in the documentation of the device:



DANGER

The DANGER signal word indicates an imminently hazardous situation. It calls attention to a procedure, practice, or the like, which, if not correctly performed or adhered to, will result in death or serious personal injury. Do not proceed beyond a DANGER signal word until the indicated conditions are fully understood and met.



WARNING

The WARNING signal word indicates a potentially hazardous situation. It calls attention to a procedure, practice, or the like, which, if not correctly performed or adhered to, could result in death or serious personal injury. Do not proceed beyond a WARNING signal word until the indicated conditions are fully understood and met.



CAUTION

The CAUTION signal word indicates a potentially hazardous situation. It calls attention to an operating procedure, practice, or the like, which, if not correctly performed or adhered to, may result in minor or moderate personal injury, material damage, particularly to the product, destruction of part or all of the product, or loss of data. Do not proceed beyond a CAUTION signal word until the indicated conditions are fully understood and met.

Note Signal Words

The following note signal words could appear in the documentation of the device:

IMPORTANT

The IMPORTANT signal word calls attention to a note that provides important information, or information essential to the completion of a task.

NOTE

The NOTE signal word calls attention to an operating procedure, practice, or the like, which requires special attention. A note also denotes related parenthetical information that is useful, but not imperative.

TIP

The TIP signal word calls attention to a type of note that helps you apply the techniques and procedures described in the manual to your specific needs, or provides hints on how to effectively use the capabilities of the product.

Safety

Before turning on the device, verify that the correct safety precautions have been taken (see the following warnings). In addition, note the external markings on the device, which are described under “Safety Symbols.”

Warnings



WARNING

General Warnings

- Carefully read the instructions contained in this instruction manual prior to turning on the device.
- Keep this instruction manual in a safe place for further reference.

- Follow the installation and operation procedures.
- It is imperative to respect the safety warnings on the device and in this instruction manual.
- If the equipment is used in a manner not specified by the manufacturer, the protection provided by the equipment could be impaired.
- Do not install substitute parts or perform any unauthorized modification to the device.
- Service instructions, when applicable, are for trained service personnel. To avoid the risk of electric shock, do not perform any work on the device unless qualified to do so. For any problem or question regarding this device, contact Evident or an authorized Evident representative.
- Do not touch the connectors directly by hand. Otherwise, a malfunction or electric shock may result.
- Do not allow metallic or foreign objects to enter the device through connectors or any other openings. Otherwise, a malfunction or electric shock may result.

**WARNING****Electrical Warning**

The device must only be connected to a power source corresponding to the type indicated on the rating label.

**CAUTION**

If a non-approved power supply cord not dedicated to Evident products is used, Evident will not be able to ensure the electrical safety of the equipment.

Battery Precautions**CAUTION**

- Before disposing of a battery, check your local laws, rules, and regulations, and follow them accordingly.

- Transportation of lithium-ion batteries is regulated by the United Nations under the United Nations Recommendations on the Transport of Dangerous Goods. It is expected that governments, intergovernmental organizations, and other international organizations shall conform to the principles laid down in these regulations, thus contributing to worldwide harmonization in this field. These international organizations include the International Civil Aviation organization (ICAO), the International Air Transport Association (IATA), the International Maritime Organization (IMO), the US Department of Transportation (USDOT), Transport Canada (TC), and others. Please contact the transporter and confirm current regulations before transportation of lithium-ion batteries.
- For California (USA) only:
The device may contain a CR battery. The CR battery contains perchlorate material, and special handling may be required. Refer to <http://www.dtsc.ca.gov/hazardouswaste/perchlorate>.
- Do not open, crush, or perforate batteries; doing so could cause injury.
- Do not incinerate batteries. Keep batteries away from fire and other sources of extreme heat. Exposing batteries to extreme heat (over 80 °C) could result in an explosion or personal injury.
- Do not drop, hit, or otherwise abuse a battery, as doing so could expose the cell contents, which are corrosive and explosive.
- Do not short-circuit the battery terminals. A short circuit could cause injury and severe damage to a battery making it unusable.
- Do not expose a battery to moisture or rain; doing so could cause an electric shock.
- Only use an external charger approved by Evident to charge the batteries.
- Only use batteries supplied by Evident.
- Do not store batteries that have less than 40 % remaining charge. Recharge batteries to between 40 % and 80 % capacity before storing them.
- During storage, keep the battery charge between 40 % and 80 %.
- Do not leave batteries in the BondMaster 600 unit during device storage.

Regulations for Shipping Products with Lithium-Ion Batteries

IMPORTANT

When shipping a Li-ion battery or batteries, be sure to follow all local transportation regulations.



WARNING

Damaged batteries cannot be shipped through normal routes — DO NOT ship damaged batteries to Evident. Contact your local Evident representative or material disposal professionals.

Equipment Disposal

Before disposing of the BondMaster 600, check your local laws, rules, and regulations, and follow them accordingly.

BC (Battery Charger - California, USA Community)



The BC marking indicates that this product has been tested and complies with the Appliance Efficiency Regulations as stated in the California Code of Regulations Title 20, Sections 1601 through 1608 for Battery Charger Systems. The internal battery charger within this device has been tested and certified pursuant to the California Energy Commission's (CEC) requirements; this device is listed on the online CEC's (T20) database.

CE (European Community)



This device complies with the requirements of directive 2014/30/EU concerning electromagnetic compatibility, directive 2014/35/EU concerning low voltage, and directive 2015/863 which amends 2011/65/EU concerning restriction of hazardous substances (RoHS). The CE marking is a declaration that this product conforms to all the applicable directives of the European Community.

UKCA (United Kingdom)



This device complies with the requirements of the Electromagnetic Compatibility Regulations 2016, the Electrical Equipment (Safety) Regulations 2016, and the Restriction of the Use of Certain Hazardous Substances in Electrical and Electronic Equipment Regulations 2012. The UKCA marking indicates compliance with the above regulations.

RCM (Australia)



The regulatory compliance mark (RCM) label indicates that the product complies with all applicable standards, and has been registered with the Australian Communications and Media Authority (ACMA) for placement on the Australian market.

WEEE Directive



In accordance with European Directive 2012/19/EU on Waste Electrical and Electronic Equipment (WEEE), this symbol indicates that the product must not be disposed of as unsorted municipal waste, but should be collected separately. Refer to your local Evident distributor for return and/or collection systems available in your country.



China RoHS

China RoHS is the term used by industry generally to describe legislation implemented by the Ministry of Information Industry (MII) in the People's Republic of China for the control of pollution by electronic information products (EIP).



The China RoHS mark indicates the product's Environment-Friendly Use Period (EFUP). The EFUP is defined as the number of years for which listed controlled substances will not leak or chemically deteriorate while in the product. The EFUP for the BondMaster 600 has been determined to be 15 years.

Note: The Environment-Friendly Use Period (EFUP) is not meant to be interpreted as the period assuring functionality and product performance.



本标志是根据“电器电子产品有害物质限制使用管理办法”以及“电子电气产品有害物质限制使用标识要求”的规定，适用于在中国销售的电器电子产品上的电器电子产品有害物质使用限制标志。

电器电子产品有
害物质限制使用
标志

(注意) 电器电子产品有害物质限制使用标志内的数字为在正常的使用条件下有害物质等不泄漏的期限，不是保证产品功能性能的期间。

产品中有害物质的名称及含量

部件名称		有害物质					
		铅及其化合物 (Pb)	汞及其化合物 (Hg)	镉及其化合物 (Cd)	六价铬及其化合物 (Cr(VI))	多溴联苯 (PBB)	多溴二苯醚 (PBDE)
主体	机构部件	×	○	○	○	○	○
	光学部件	×	○	○	○	○	○
	电气部件	×	○	○	○	○	○

产品中有害物质的名称及含量

部件名称	有害物质					
	铅及其化合物 (Pb)	汞及其化合物 (Hg)	镉及其化合物 (Cd)	六价铬及其化合物 (Cr(VI))	多溴联苯 (PBB)	多溴二苯醚 (PBDE)
附件	×	○	○	○	○	○
本表格依据 SJ/T 11364 的规定编制。 ○：表示该有害物质在该部件所有均质材料中的含量均在 GB/T26572 规定的限量要求以下。 ×：表示该有害物质至少在该部件的某一均质材料中的含量超出 GB/T26572 规定的限量要求。						

Korea Communications Commission (KCC)



Seller and user shall be noticed that this equipment is suitable for electromagnetic equipment for office work (class A) and it can be used outside the home. This device complies with the EMC requirements of Korea.

The MSIP code for the device is the following: MSIP-REM-OYN-B600.

이 기기는 업무용 환경에서 사용할 목적으로 적합성평가를 받은 기기로서 가정용 환경에서 사용하는 경우 전파간섭의 우려가 있습니다.

EMC Directive Compliance

This equipment generates and uses radio-frequency energy and, if not installed and used properly (that is, in strict accordance with the manufacturer's instructions), may cause interference. The BondMaster 600 has been tested and found to comply with the limits for an industrial device in accordance with the specifications of the EMC directive.

FCC (USA) Compliance

NOTE

This product has been tested and found to comply with the limits for a Class A digital device, pursuant to Part 15 of the FCC Rules. These limits are designed to provide reasonable protection against harmful interference when the product is operated in a commercial environment. This product generates, uses, and can radiate radio frequency energy, and if not installed and used in accordance with the instruction manual, might cause harmful interference to radio communications. Operation of this product in a residential area is likely to cause harmful interference, in which case you will be required to correct the interference at your own expense.

IMPORTANT

Changes or modifications not expressly approved by the party responsible for compliance could void the user's authority to operate the product.

FCC Supplier's Declaration of Conformity

Hereby declares that the product,

Product name: BondMaster 600

Model: BondMaster 600-MR/BondMaster 600-CW

Conforms to the following specifications:

FCC Part 15, Subpart B, Section 15.107 and Section 15.109.

Supplementary information:

This device complies with Part 15 of the FCC Rules. Operation is subject to the following two conditions:

- (1) This device may not cause harmful interference.
- (2) This device must accept any interference received, including interference that may cause undesired operation.

Responsible party name:

EVIDENT SCIENTIFIC INC.

Address:

48 Woerd Avenue, Waltham, MA 02453, USA

Phone number:

+1 781-419-3900

ICES-001 (Canada) Compliance

This Class A digital apparatus complies with Canadian ICES-001.

Cet appareil numérique de la classe A est conforme à la norme NMB-001 du Canada.

Warranty Information

Evident guarantees your Evident product to be free from defects in materials and workmanship for a specific period, and in accordance with conditions specified in the Terms and Conditions available at <https://www.olympus-ims.com/en/terms/>.

The Evident warranty only covers equipment that has been used in a proper manner, as described in this instruction manual, and that has not been subjected to excessive abuse, attempted unauthorized repair, or modification.

Inspect materials thoroughly on receipt for evidence of external or internal damage that might have occurred during shipment. Immediately notify the carrier making the delivery of any damage, because the carrier is normally liable for damage during shipment. Retain packing materials, waybills, and other shipping documentation needed in order to file a damage claim. After notifying the carrier, contact Evident for assistance with the damage claim and equipment replacement, if necessary.

This instruction manual explains the proper operation of your Evident product. The information contained herein is intended solely as a teaching aid, and shall not be used in any particular application without independent testing and/or verification by the operator or the supervisor. Such independent verification of procedures becomes increasingly important as the criticality of the application increases. For this reason, Evident makes no warranty, expressed or implied, that the techniques, examples, or procedures described herein are consistent with industry standards, nor that they meet the requirements of any particular application.

Evident reserves the right to modify any product without incurring the responsibility for modifying previously manufactured products.

Technical Support

Evident is firmly committed to providing the highest level of customer service and product support. If you experience any difficulties when using our product, or if it fails to operate as described in the documentation, first consult the user's manual, and then, if you are still in need of assistance, contact our After-Sales Service. To locate the nearest service center, visit the Service Centers page on the Evident Scientific Web site.

Introduction

This user's manual provides operating instructions for the Evident BondMaster 600 composite bond tester, which uses acoustic and ultrasonic waves to detect surface flaws in various types of composite materials (see Figure i-1 on page 25). The manual's information is organized to explain the BondMaster 600 technology, safety details, hardware, and software.

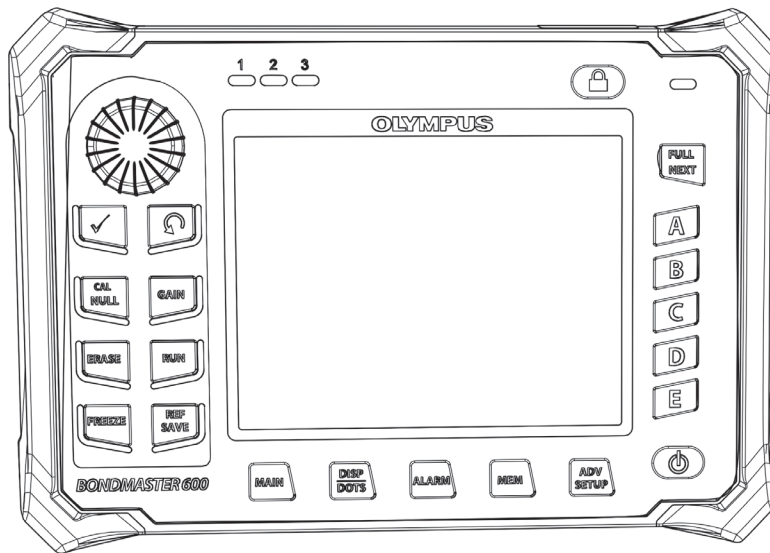

Figure i-1 BondMaster 600

1. Package Contents

The BondMaster 600 is available in two different models:

- B600: Basic instrument featuring all pitch-catch modes
- B600M: Multi-mode instrument including pitch-catch, mechanical impedance analysis (MIA), and resonance modes

Before using the BondMaster 600 for the first time, you must inspect the package contents to make sure there are no missing or defective items.

1.1 Unpacking

All cartons should be opened and inspected upon receipt. The cartons and contents should be inspected for any signs of damage that may have occurred during shipment. If damage is noted, contact the carrier and retain the damaged shipping materials until an inspection can be performed by a representative of the carrier. With the exception of the universal battery charger/adaptor and external accessories, all BondMaster 600 options are installed before the instrument is shipped. Check the contents of the carton or cartons against the packing list to ensure that all ordered accessories have been received.

1.2 Initial Inspection

After the BondMaster 600 has been unpacked and the contents of the carton have been checked against the packing list, a visual inspection and a basic operation test should be performed as follows:

To perform the initial inspection

1. Check if there is cosmetic or structural damage to the packaging and the BondMaster 600.
2. Turn on the BondMaster 600 power.
3. Let the BondMaster 600 perform the “Power-On Self Test.”
4. Confirm that the “Sign-On” message is displayed.

1.3 Contents of the Case

The BondMaster 600 comes with several key accessories (see Figure 1-1 on page 29):

- Calibration certificate (Evident P/N: B600-CERT [U8010093]).
- Charger/adaptor (Evident P/N: EP-MCA-X), where “X” denotes the AC power cord type (see Table 16 on page 230).
- AC power cord
- Transport case (Evident P/N: 600-TC [U8780294])
- *Getting Started Guide* (Evident P/N: DMTA-10044-01XX, where “XX” denotes the language (see Table 18 on page 230 for order numbers)
- BondMaster 600 *User’s Manual* and PC interface program on CD-ROM (Evident P/N: B600-CD [U8141002])
- MicroSD Memory Card, 2 GB (Evident P/N: MICROSD-ADP-2GB [U8779307])
- USB communication cable (Evident P/N: EPLTC-C-USB-A-6 [U8840031])
- 600 Series rechargeable Li-ion battery; 10.8 V, 6.8 Ah, 73 Wh (Evident P/N: 600-BAT-L-2 [U8760058])
- 8-cell battery holder with connector plug (Evident P/N: 600-BAT-AA [U8780295])
- Pitch-catch and MIA mode cable for BondMaster 600; 3.3 m (11 ft) length, 11-pin to 11-pin connectors (Evident P/N: SBM-CPM-P11 [U8800058])
- Resonance mode cable for BondMaster 600; 1.8 m (6 ft) length, 11-pin to 6-pin connectors (Evident P/N: SBM-CR-P6 [U8800059])
- Factory-installed wrist strap on left side of BondMaster 600 (Evident P/N: 38DLP-HS [U8779371])

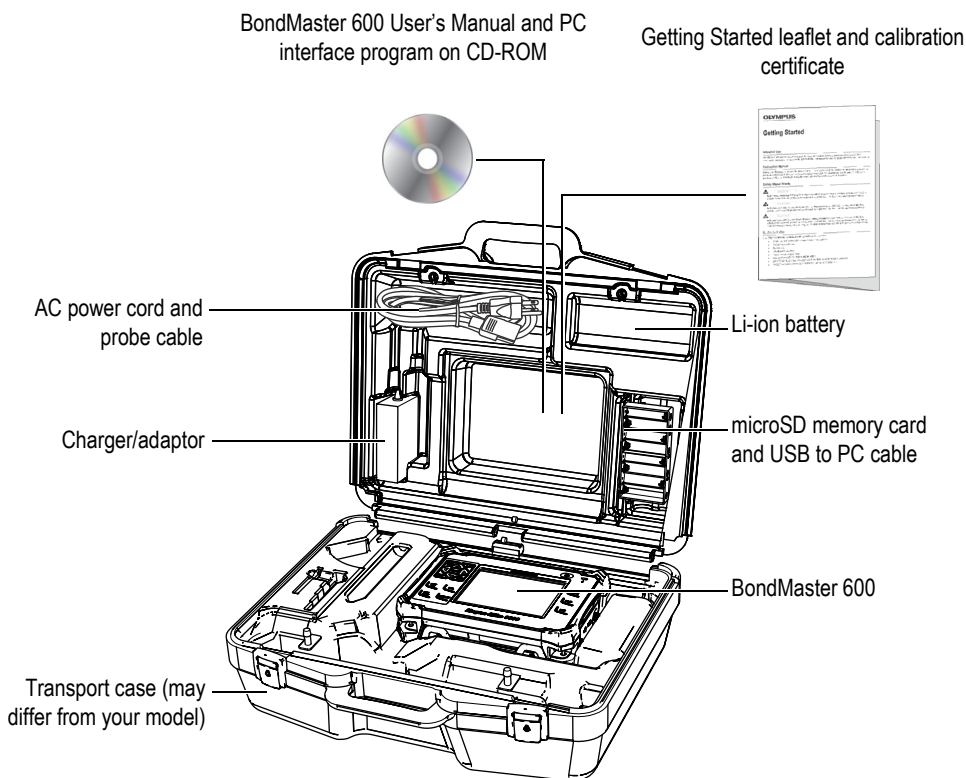

Figure 1-1 Transport case contents

A list of optional accessories available from Evident can be found in "Accessories, Replacement Parts, and Upgrades" on page 229.

2. Overview of the BondMaster 600

This chapter provides a brief overview of the BondMaster 600 composite bond tester, and includes the principle of operation, accessories, and all common operational requirements.

2.1 Operating Principle and Test Techniques

The BondMaster 600 is a versatile test instrument that is capable of operating in several different modes (using various techniques) to test many different types of composite materials for structural integrity, providing assurance that there are no adhesive disbonds or delaminations. Throughout the different modes of operation, many different probe types and designs are used, depending on the test object and geometry. Custom probes can be designed and manufactured for specific applications. The BondMaster 600 is a very lightweight and portable instrument, and it can operate using either an internal battery or an alternating current power source from 90 V to 240 V, with a frequency of 50 Hz or 60 Hz.

In all of the various test modes in which the BondMaster 600 operates (using a range of probes), the alternating electric current causes oscillations in the piezoelectric crystals in the probes. Depending on the test mode, the crystal oscillations cause vibrations that are used in different ways as they are transferred into the test specimen.

In pitch-catch mode (for all test techniques), the crystal oscillations induce vibrations in the “virtual” membrane caused by disbonding of a section of the composite material. The disbond defect acts like a membrane that vibrates more easily than the rest of the bonded structure. The membrane responds more easily to induced vibrations and generates greater amplitude oscillations than the surrounding material.

Defect detection in pitch-catch mode is achieved by detecting a greater amplitude oscillation at the receiving crystal. In the pitch-catch mode's RF and IMPULSE test techniques (fixed frequency test), near-surface and far-surface disbonds can be detected. The IMPULSE technique applies an envelope filter to the receiving signals. (The name "IMPULSE" originates from earlier BondMaster products.) The pitch-catch mode's SWEPT test technique, however, sweeps over a range of frequencies, which is more suitable, for example, for the varying thicknesses of aircraft flaps or stabilizers. The pitch-catch SWEPT test technique is also particularly well-suited for aluminum core honeycomb composites.

In Mechanical Impedance Analysis (MIA) mode and Resonance mode, the oscillations generated by the probe's emitting crystal are also transferred into the test specimen, but in a more rigid way. The probe uses the specimen's oscillations to sense changes in mechanical impedance, rather than using the membrane vibrations as with pitch-catch mode and test techniques.

In MIA mode, the mechanical impedance is detected through the restricted movement of a receiving crystal that is included in the mechanical drive circuit. The receiving crystal is coupled to the test specimen by means of a solid shaft (the probe tip). The other side of the receiving crystal is coupled to the emitting crystal through a semi-elastic material. As a result, the receiving crystal becomes more or less restricted as the mechanical impedance of the test specimen changes. If a defect is present, the probe tip oscillates more freely, and the receiving crystal is subjected to a lower alternating mechanical pressure, which generates a weaker amplitude voltage that is detected by the instrument. However, if the test specimen has a greater mechanical impedance (for example, for honeycomb composite potted repairs) the receiving crystal's movement becomes even more restrained, which results in increased pressure and amplitude signals at the receiving crystal. MIA mode is therefore an excellent way of identifying potted repairs and crushed cores in honeycomb composites. Typically, MIA mode is able to detect smaller disbonds than the pitch-catch mode.

Resonance mode, like MIA mode, can also be used to monitor the mechanical impedance of the test specimen. (Incidentally, the term "resonance" may be misleading, as it refers to probe resonance and NOT part resonance.) In resonance mode, the probe's crystal is coupled to passive electronic components that form a resonant filter. The single crystal must be coupled to the test specimen using a low viscosity couplant. Because the crystal becomes part of the resonant circuit, any changes in its electrical impedance will affect the resonant point (phase and amplitude). The crystal's electrical impedance is affected by the mechanical impedance of the test specimen, which is coupled to the crystal when a resonance test is performed. Changes in mechanical impedance occur when disbonds or interply

delamination are present. Any changes in the part's mechanical impedance are reflected in the amplitude and phase displayed on the instrument screen. Resonance mode is typically used to detect metal-to-metal disbonds and interply delaminations. In carbon fiber or fiberglass composites, the location of the defect can often be estimated using the phase deflection on the instrument screen.

2.2 Connectors

Figure 2-1 on page 33 illustrates the connections of the BondMaster 600 with the charger/adaptor, the microSD card, and a personal computer (PC).

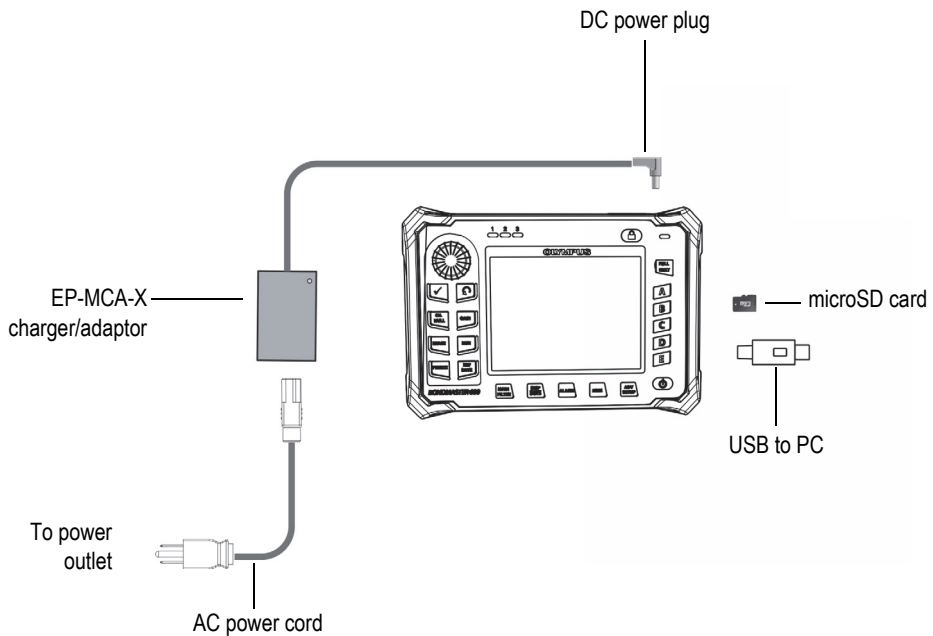

Figure 2-1 The BondMaster 600 connections



WARNING

Use only the AC power cord supplied with your BondMaster 600, unless specifically instructed in the manual. Using an unauthorized power cord may result in damage to the instrument or serious human injury.

The DC power and PROBE connectors are located on the top end of the BondMaster 600 (see Figure 2-2 on page 34).

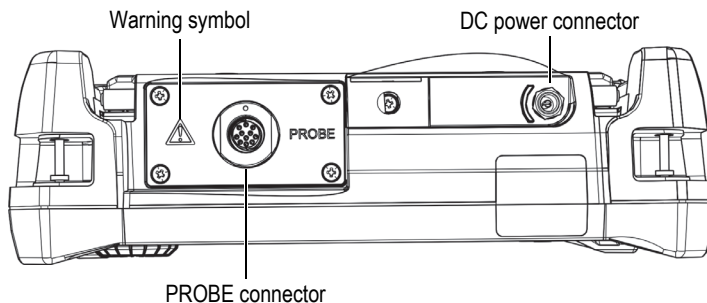

Figure 2-2 The top end connectors



CAUTION

Do not allow metallic or foreign objects to enter the device through connectors or any other openings. Otherwise, an electric shock or malfunction may result. To avoid the risk of an electric shock, do not touch the inner conductors of the PROBE connector. Up to 80 V can be present.

The USB port and the removable microSD memory card slot are located on the right-hand side of the BondMaster 600, hidden behind the input/output (I/O) door (see Figure 2-3 on page 35).

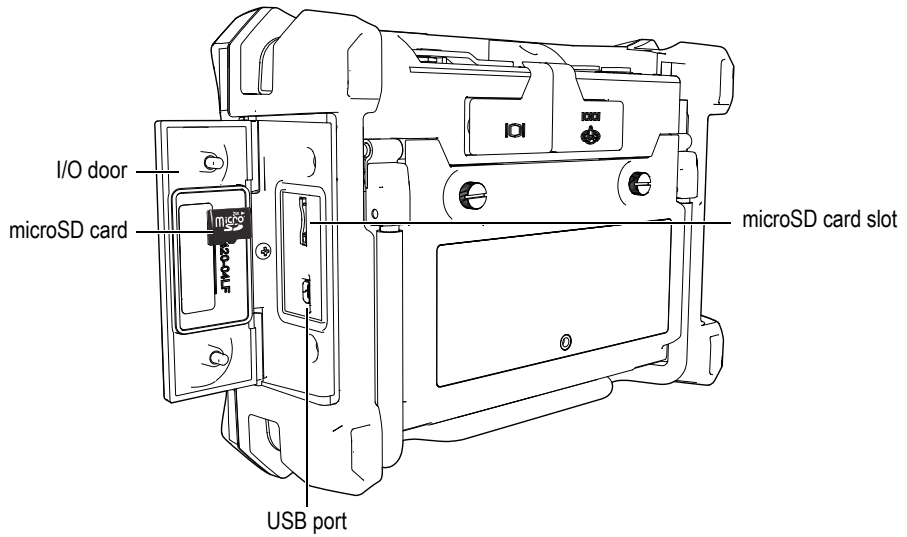

Figure 2-3 The connectors behind the I/O door

The I/O and the VGA OUT connectors are located at the back of the BondMaster 600, in the upper section (see Figure 2-4 on page 36). A rubber cover protects each connector.

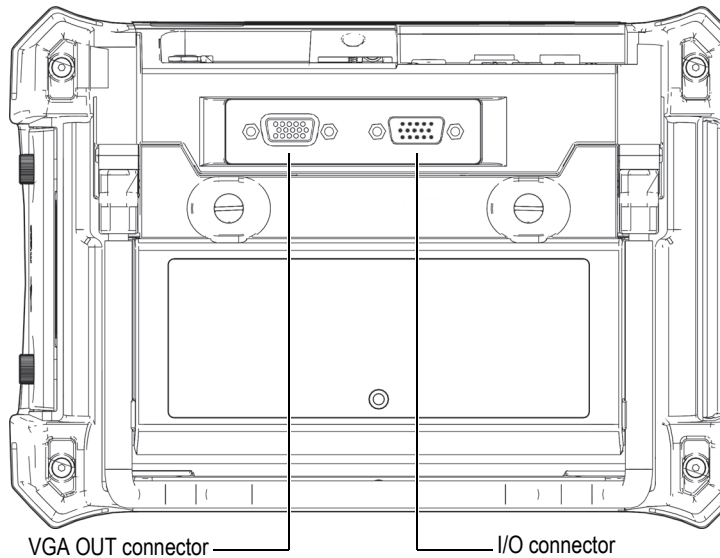

Figure 2-4 The I/O and VGA OUT connectors

2.3 Power Requirements

The BondMaster 600 is designed to operate using three power supply methods:

- Directly from the BondMaster 600 charger/adaptor
- Internal lithium-ion battery
- Internal alkaline battery holder

Press the power button (🔌) to turn on the BondMaster 600 (see Figure 2-5 on page 37). Pressing this button once causes an initial beep, followed by the startup screen and a second beep approximately five seconds later.

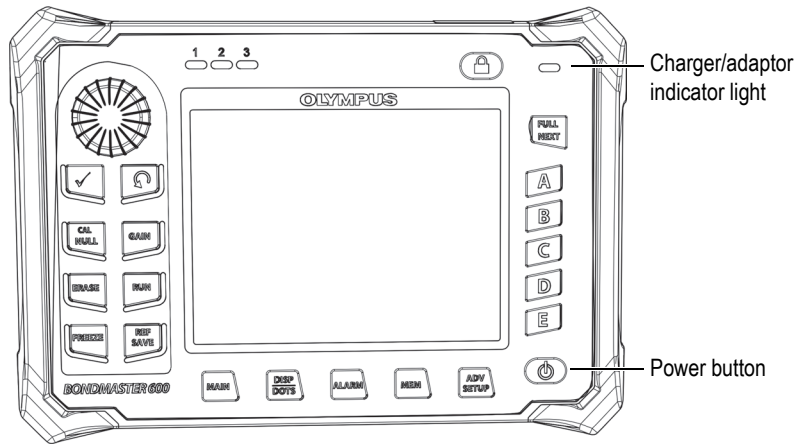

Figure 2-5 Location of the BondMaster 600 power button and indicator light

2.3.1 Charger/Adaptor

The BondMaster 600 charger/adaptor is provided with every instrument. This charger/adaptor is the primary method for powering the BondMaster 600 with or without a battery installed. It is also used to charge the lithium-ion rechargeable battery when installed in the BondMaster 600. A charger/adaptor indicator light on the front panel of the instrument displays the current status of the charger/adaptor (see Figure 2-5 on page 37 and Figure 2-6 on page 37).



Figure 2-6 The charger/adaptor indicator light on the front panel



WARNING

Use only the power cord supplied with your BondMaster 600, unless specifically instructed in the manual. Using an unauthorized power cord may result in damage to the instrument or serious human injury.

**WARNING**

The BondMaster 600 charger/adaptor (P/N: EP-MCA-X) is designed to power the BondMaster 600 and charge the lithium-ion battery only (P/N: 600-BAT-L-2 [U8760058]).

Do not attempt to charge any other types of batteries, including alkaline batteries in the battery holder (P/N: 600-BAT-AA [U8780295]), and do not attempt to use any other charger/adaptor. Doing so might cause an explosion or injury. Do not attempt to power or charge other electronic equipment with the charger/adaptor (P/N: EP-MCA-X), unless specifically instructed in the manual. Misuse of the charger/adaptor can cause other batteries and/or instruments to explode, which could lead to serious injury or death.

To connect the charger/adaptor

1. Connect the AC power cord to the charger/adaptor and to an appropriate power outlet (see Figure 2-7 on page 38).

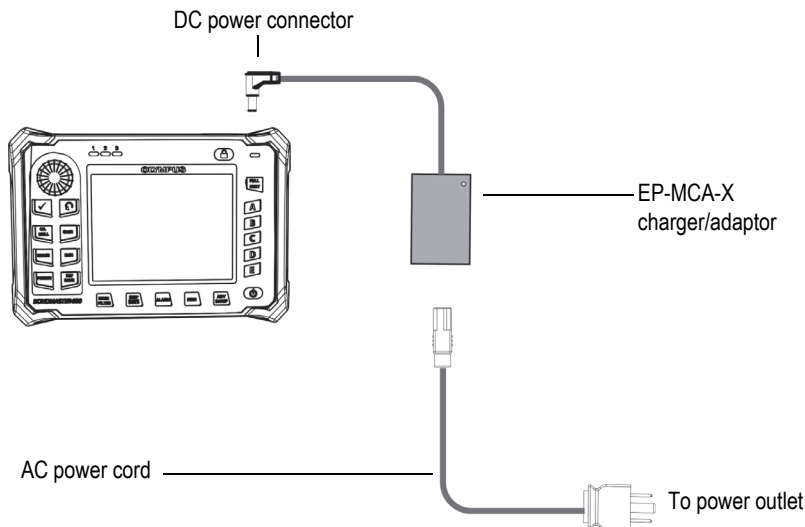

Figure 2-7 Connecting the charger/adaptor

2. Lift the rubber seal that covers the DC connector on top of the BondMaster 600.
3. Connect the DC output power cable from the charger/adaptor to the DC power connector on top of the BondMaster 600 (see Figure 2-8 on page 39).

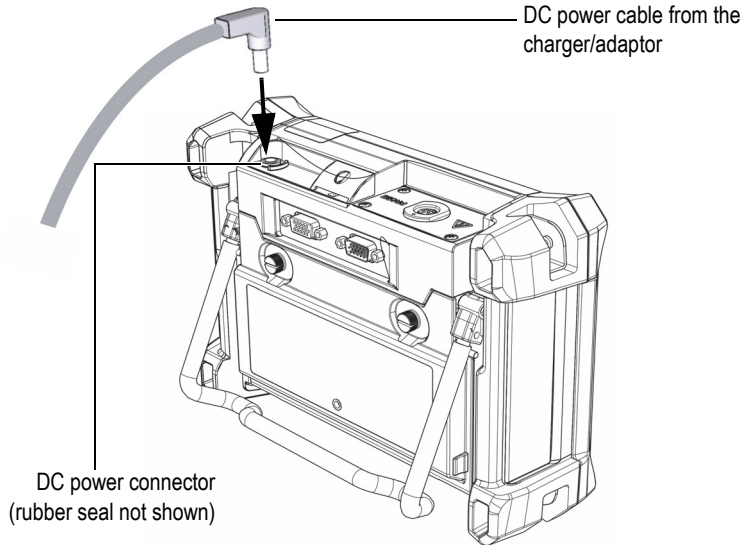





Figure 2-8 Connecting the DC power cable

Table 1 on page 40 explains the indicators for the power status of the charger/adaptor and the battery charge condition, which are visible at the top of the front panel and in the user interface.

Table 1 Charger/adaptor and battery indicators

Charger/adaptor indicator light	AC line power connected	Indicator meaning	Battery indicator
Red	Yes	Internal battery is charging.	
Off	No	Charger/adaptor is not connected.	
Green	Yes	Internal battery is fully charged. OR Charger/adaptor is connected, but no battery is installed.	

2.3.2 Battery Compartment

The BondMaster 600 battery compartment cover allows you to quickly access the battery (or AA batteries in the battery holder) without the need for tools. Two thumb screws on the battery compartment cover secure it to the BondMaster 600 case and ensure the compartment is sealed.

The battery compartment cover also has a small hole in the bottom center area that is covered on the inside by an environmentally sealed membrane vent. This vent is a safety feature that is required in the event that the BondMaster 600 battery fails and emits gas. This vent must not be punctured.

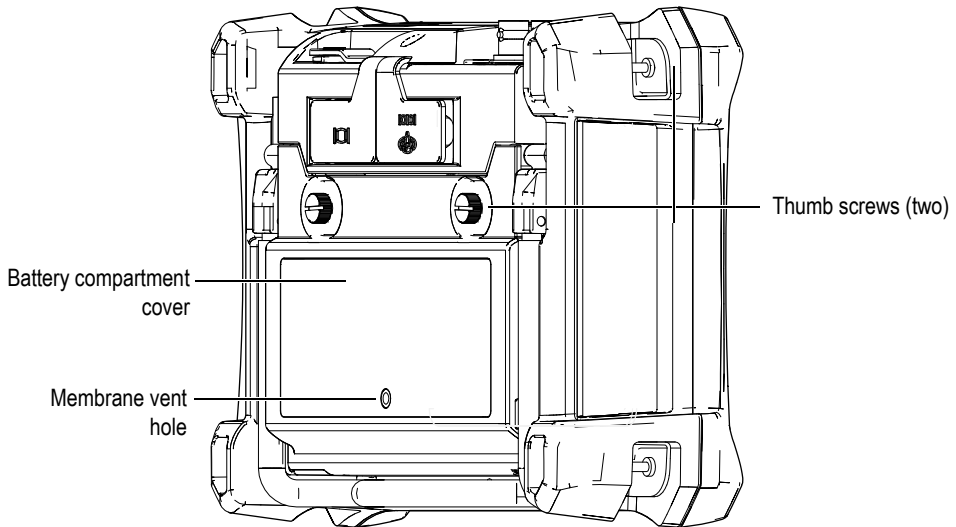

Figure 2-9 The battery compartment

The BondMaster 600 accepts one rechargeable lithium-ion battery pack (Evident P/N: 600-BAT-L-2 [U8760058]) that can be recharged inside the BondMaster 600 or on the optional external charging base (Evident P/N: EPXT-EC-X). You can also use the BondMaster 600 with eight standard AA-size alkaline batteries installed in a battery holder (Evident P/N: 600-BAT-AA [U8780295]) for extended portable use.



WARNING

If the BondMaster 600 is to be used with a rechargeable battery, only use the Evident battery, P/N: 600-BAT-L-2 [U8760058]. Using any other type of battery might cause an explosion and injury.

2.3.3 Lithium-Ion Battery

The BondMaster 600 is normally used as a portable instrument powered by the lithium-ion battery and recharged via the charger/adaptor (both are supplied with the BondMaster 600). When properly maintained, and when the BondMaster 600 is operated under typical inspection conditions, the lithium-ion battery should provide between 8 and 10 hours of continuous operation.

IMPORTANT

The lithium-ion battery is not fully charged when the BondMaster 600 is shipped. You must charge the battery for two to three hours before using battery power to operate the BondMaster 600 (see “Charger/Adaptor” on page 37).

To install or replace the lithium-ion battery

1. Unfold the BondMaster 600 stand (see Figure 2-10 on page 43).
2. At the back of the BondMaster 600, loosen the two thumb screws securing the battery compartment cover.
3. Remove the battery compartment cover.
4. Remove the battery and/or install the battery in the battery compartment.
5. Ensure that the gasket of the battery compartment cover is clean and in good condition.
6. Install the battery compartment cover at the back of the BondMaster 600, and then tighten the two thumb screws to complete the installation.

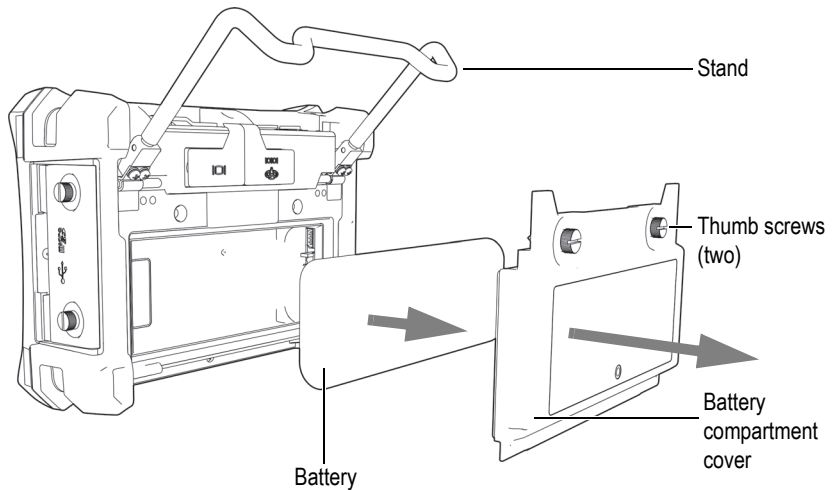

Figure 2-10 Removing the lithium-ion battery

2.3.4 Alkaline Batteries

The BondMaster 600 has an battery holder (Evident P/N: 600-BAT-AA [U8780295]). This holder accommodates eight AA-size alkaline batteries for situations where an AC power source is not available and the internal Li-ion battery is discharged. When operated under typical inspection conditions, the alkaline batteries typically provide three hours of continuous operation.

To install the alkaline battery holder

1. Unfold the BondMaster 600 stand (see Figure 2-11 on page 44).
2. Loosen the two thumb screws securing the battery compartment cover at the back of the BondMaster 600, and then remove the battery compartment cover.
3. Remove the lithium-ion battery, if installed.
4. Install eight AA-size alkaline batteries into the alkaline battery holder.
5. Connect the alkaline battery holder connector to the BondMaster 600.
6. Position the alkaline battery holder in the battery compartment.
7. Install the battery compartment cover at the back of the BondMaster 600, and then tighten the two thumb screws.

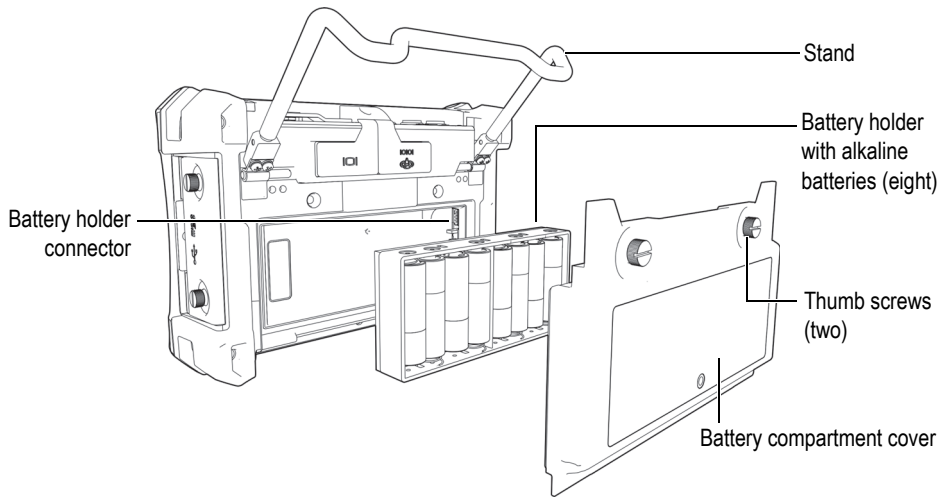

Figure 2-11 The alkaline battery holder

NOTE

When alkaline batteries are installed in the BondMaster 600, the battery indicator in the user interface displays **ALK**. The charger/adaptor does not recharge the batteries installed in the alkaline battery holder.

2.4 MicroSD Card Installation

A 2 GB microSD card (Evident P/N: MICROSD-ADP-2GB [U8779307]) can be installed in the BondMaster 600.

To install the microSD removable memory card

1. Remove the card from its packaging.
2. Loosen the two thumb screws, and then open the BondMaster 600 I/O door (see Figure 2-12 on page 45).

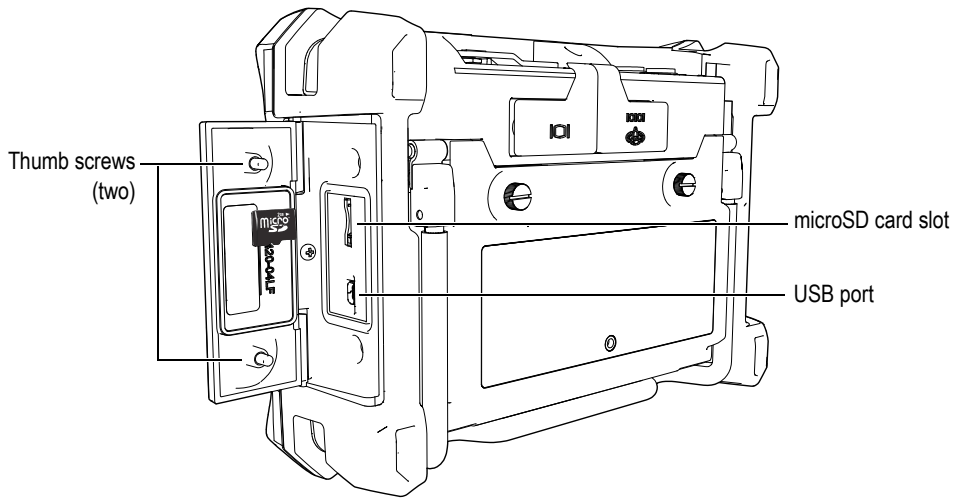

Figure 2-12 Installing the microSD card

3. Hold the card so that the microSD label faces toward the rear of the BondMaster 600.
4. Gently slide the card into the microSD slot until it clicks.

NOTE

To remove the microSD card, gently push the card into the BondMaster 600 and release. A spring-loaded mechanism will partially eject the card, and then you can grasp the card and remove it from the BondMaster 600.

2.5 BondMaster 600 Hardware Features

The BondMaster 600 has many physical features that are either completely new or improved features from the previous BondMaster 1000e+ model. It is important to become familiar with the use and maintenance of these items.

2.5.1 Hardware Overview

Figure 2-13 on page 46 and Figure 2-14 on page 47 show the main components on the BondMaster 600.

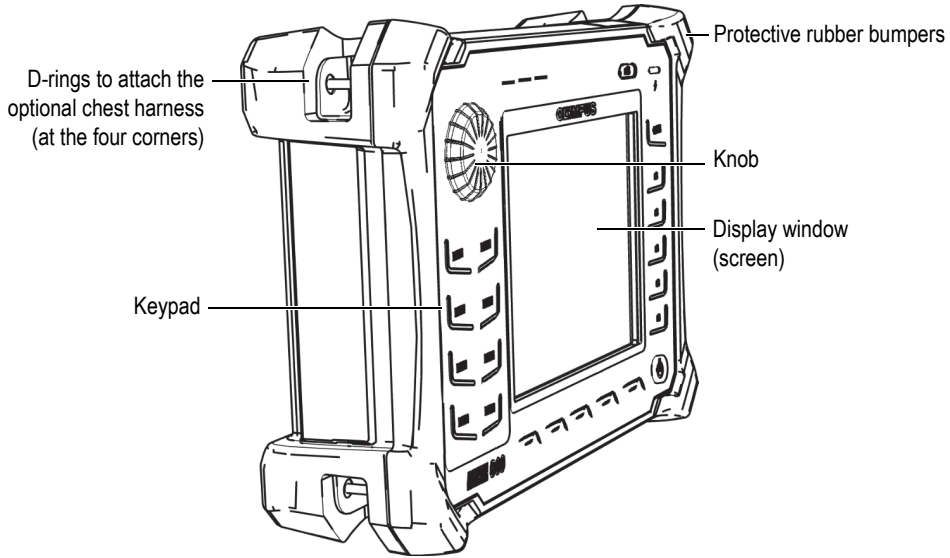

Figure 2-13 Overview of the BondMaster 600 — Front view

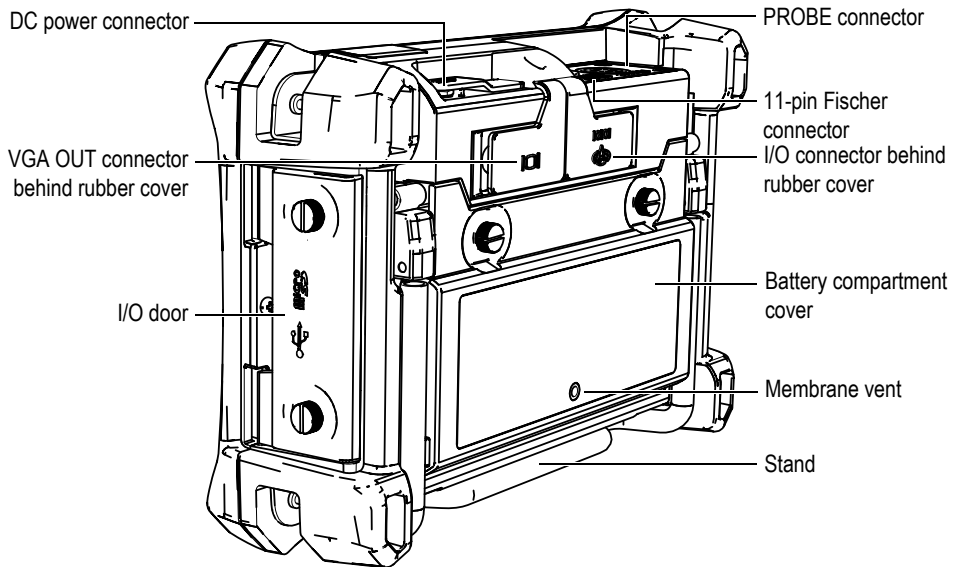

Figure 2-14 Overview of the BondMaster 600 — Back view

2.5.1.1 Front Panel and SmartKnob

The SmartKnob is an important feature of the BondMaster 600, and it is the primary method used to change different parameters within a menu. In this manual, the term “knob” is also used to refer to the SmartKnob.

The keypad on the BondMaster 600 front panel contains keys that are grouped around the display (also named screen). The keys are used in combination with the SmartKnob to provide direct access to menus and common parameters and to enable easy adjustment of values (see Figure 2-15 on page 48).

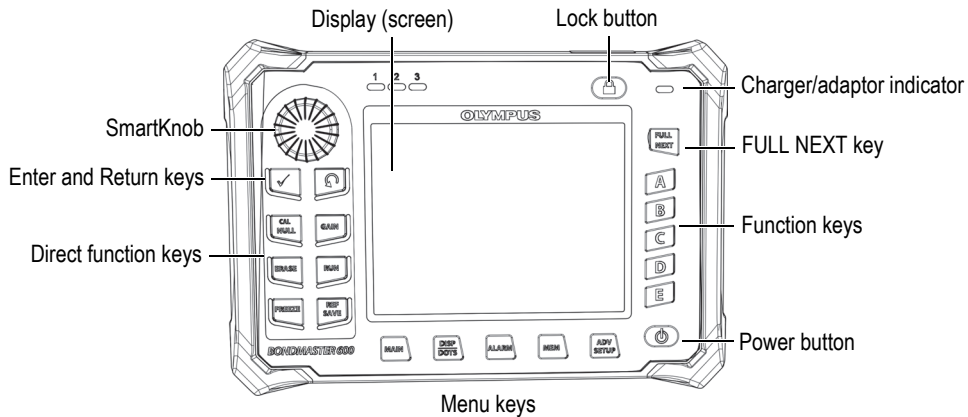

Figure 2-15 The BondMaster 600 front panel with SmartKnob and keypad

2.5.1.2 Keypad

The BondMaster 600 is available with an English, International, Chinese, or Japanese keypad configuration (see Figure 2-16 on page 49 to Figure 2-19 on page 50, and Table 2 on page 51). The text labels on some keys may be replaced by pictograms, depending on the keypad configuration. In this document, keys are referred to using the English label, which indicates its function. The keys are used to select menu items or screen parameters and to change parameter values.



Figure 2-16 The BondMaster 600 English keypad

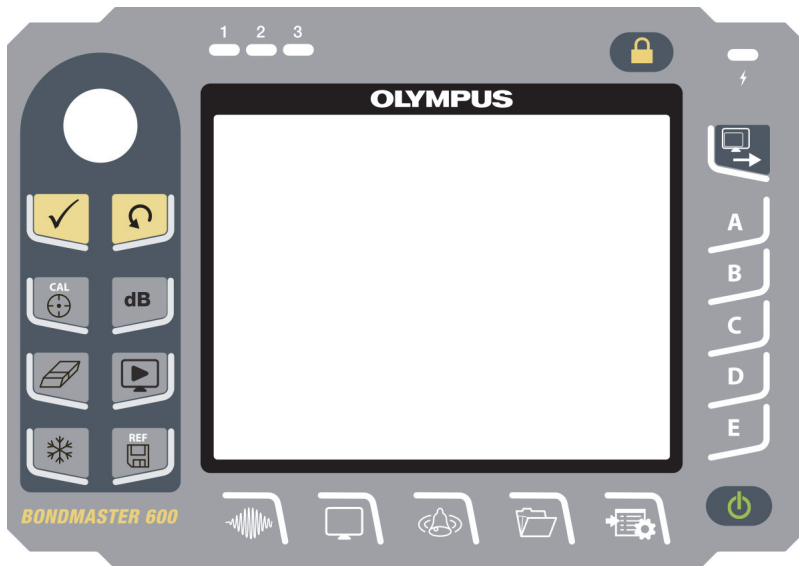

Figure 2-17 The BondMaster 600 international keypad

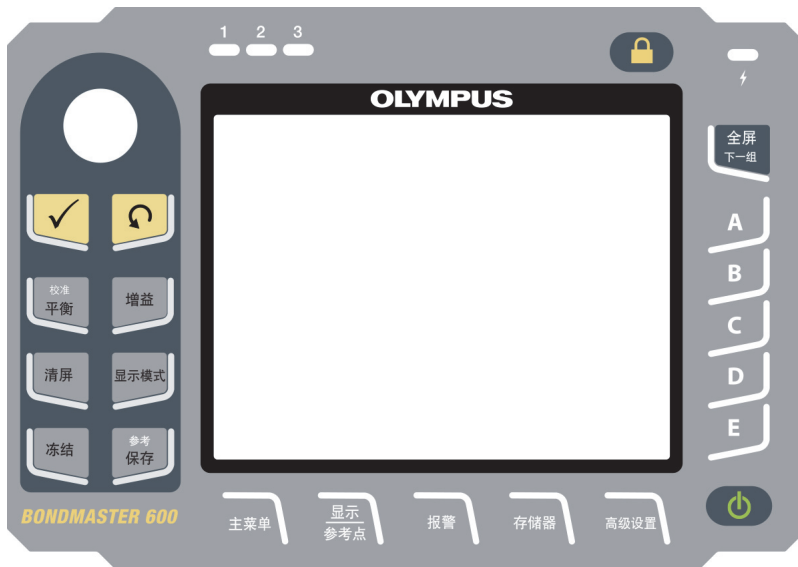

Figure 2-18 The BondMaster 600 Chinese keypad

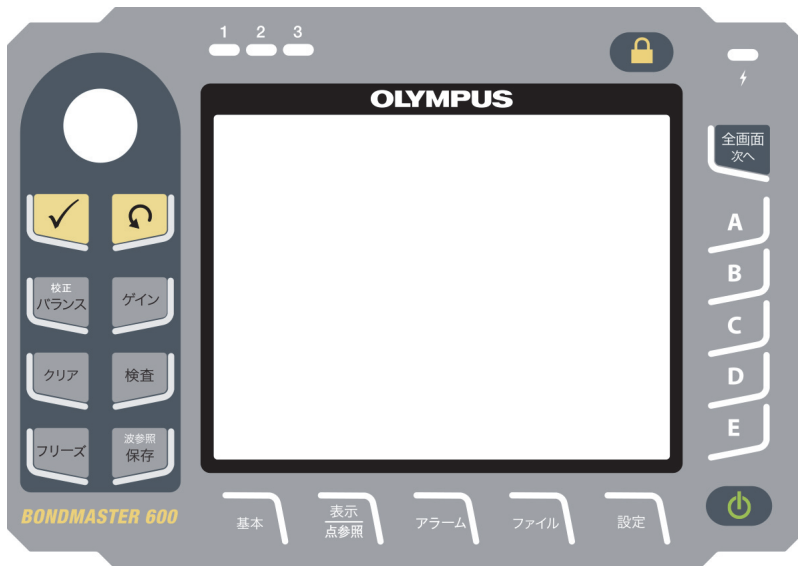

Figure 2-19 The BondMaster 600 Japanese keypad

Table 2 Keypad functions







Function name	International keypad symbol	Function description
Enter		The Enter key is used to make selections.
Return		The Return (or Back) key is used to exit a menu and return to a previous screen.
CAL/NULL		If this direct function key is pressed once, it nulls (zeros) the BondMaster 600. If this key is pressed and held, a calibration wizard is initiated in RESON (resonance) and MIA (mechanical impedance analysis) modes of operation only.
GAIN	dB	Direct function key used to display either the BondMaster 600 combined horizontal and vertical gain settings, horizontal gain only, or vertical gain only.
ERASE		Direct function key used to erase the currently displayed image.
RUN		Direct function key used to change the RUN (display) mode. Depending on the operation mode, different displays are available. NOTE: changing the RUN (display) mode also changes the available settings in the BondMaster 600 menus.
FREEZE		Direct function key used to freeze the image displayed on the BondMaster 600 for further evaluation. When the image is frozen, the BondMaster 600 also allows signal calibration, and changing the gains or angle.

Table 2 Keypad functions (*continued*)







Function name	International keypad symbol	Function description
REF/SAVE		Direct function key used to save images and settings in the BondMaster 600 memory. When this key is pressed once (and released), the currently displayed image and settings are saved. When this key is pressed and held, the current BondMaster 600 image is set as the reference memory display.
MAIN		Provides access to the main menu, which controls functions such as frequency, gain, angle, filters, RF signal, and gate.
DISP/DOTS		Provides access to the display menu, which controls functions such as display mode, position, trace, grid. Also allows you to add reference dots (not available in PC Swept mode).
ALARM		Provides access to the alarm menu, which controls functions such as alarm type, dwell time, horn, and alarm position.
MEM		Provides access to the memory menu, which controls functions such as previewing stored memory files, recalling and editing stored files, capture mode, capture time, and user information.
ADV/SETUP		Provides access to the BondMaster 600 advanced settings, including the APPLICATION SELECTION menu, the ALL SETTINGS menu, instrument mode, colors, password, systems setup, reset, calibration menu, unlock options, and legal/regulatory information.

Table 2 Keypad functions (continued)

Function name	International keypad symbol	Function description
FULL/NEXT		Used to expand the BondMaster 600 display to full screen, or to select items in the menu.
A	A	Function key
B	B	Function key
C	C	Function key
D	D	Function key
E	E	Function key

2.5.2 Connectors

The BondMaster 600 contains several types of connectors for hardware components.

2.5.2.1 PROBE Connector

The BondMaster 600 is supplied with an 11-pin Fischer (PROBE) connector.

The PROBE connector is located at the top of the BondMaster 600, on the left-hand side (see Figure 2-20 on page 53).

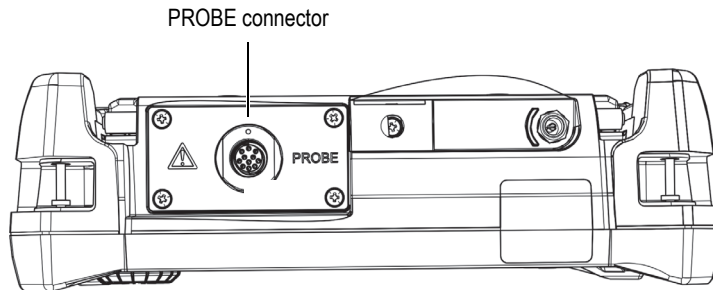

Figure 2-20 Location of the PROBE connector



CAUTION

Do not allow metallic or foreign objects to enter the device through connectors or any other openings. Otherwise, an electric shock or malfunction may result. To avoid the risk of an electric shock, do not touch the inner conductors of the PROBE connector. Up to 80 V can be present.

2.5.2.2 Input/Output and VGA OUT Connectors

The input/output (I/O) and the VGA OUT connectors are located at the back of the BondMaster 600, in the upper section (see Figure 2-21 on page 54). A rubber cover protects each connector.

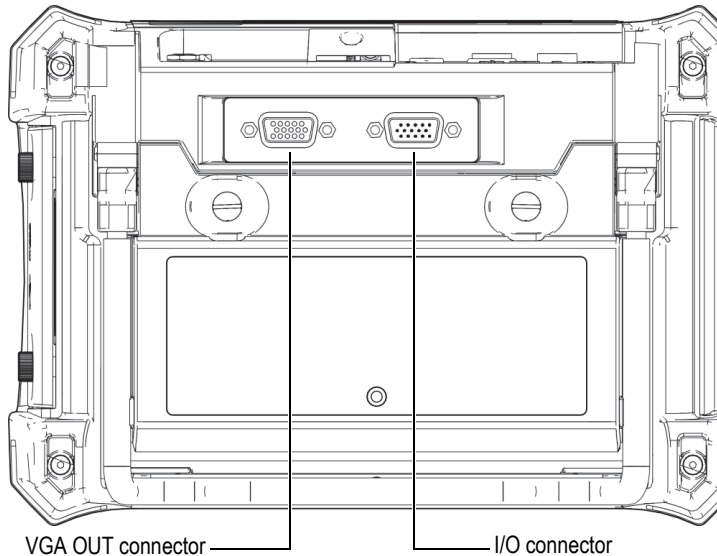

Figure 2-21 The VGA OUT and I/O connectors

The VGA OUT connector allows you to connect the BondMaster 600 to a standard analog computer monitor. The I/O connector is used to connect an external horn or, if necessary, to connect an external control for integrating the BondMaster 600 into a system. For PC communication details, see “MicroSD and USB Port” on page 55.

**CAUTION**

Do not expose the BondMaster 600 to harsh and wet environments while the I/O or the VGA OUT connectors are not protected by their rubber covers. To prevent connector corrosion and damage to the BondMaster 600, keep the rubber protective covers on the connectors when no cables are connected.

2.5.2.3 MicroSD and USB Port

On the right-hand side of the BondMaster 600, a door covers the microSD slot and the USB port (see Figure 2-22 on page 56). The I/O door closes against an integral membrane seal to keep liquids away from the unsealed connectors behind it.

The BondMaster 600 utilizes 2 GB microSD memory cards for both onboard and removable memory. The onboard 2 GB microSD card is mounted on the PC board inside the BondMaster 600, and is responsible for all onboard data storage. In the event that the BondMaster 600 is damaged beyond repair, this microSD card can be removed at an authorized service center, allowing you to recover critical data from the damaged BondMaster 600.

You can connect the BondMaster 600 to a PC via the instrument’s USB port. The BondMaster PC interface program (Evident P/N: B600-CD [U8141002]) is provided with the BondMaster 600 for PC communication and file transfers. For more details, see “BondMaster PC Software” on page 181. The BondMaster 600 can also communicate directly with other SPC programs.

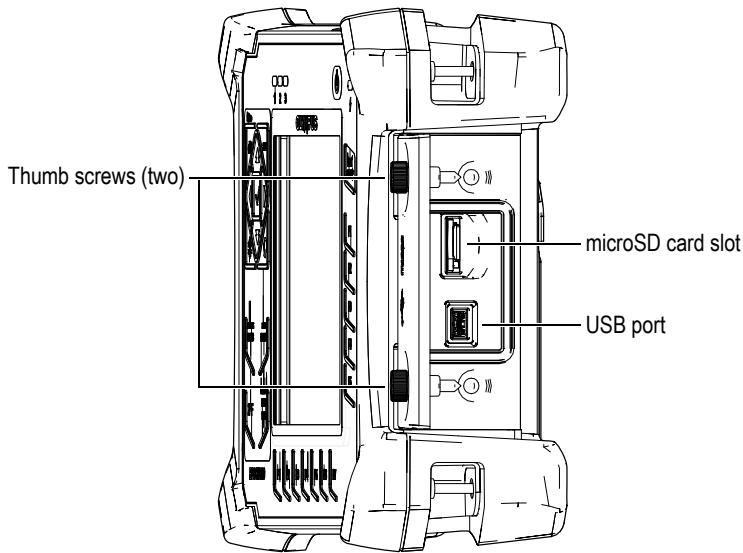

Figure 2-22 The microSD slot and USB port

The I/O door is kept closed by two thumb screws. You can also use a coin or a screwdriver to manipulate these thumb screws as needed.



CAUTION

Do not expose the BondMaster 600 to harsh and wet environments while the I/O door is open. To prevent connector corrosion and damage to the BondMaster 600, keep the I/O door closed and sealed when no cable is connected.

2.5.3 Various Hardware Features

The BondMaster 600 is equipped with physical features that make it suitable for a variety of operating environments.

2.5.3.1 BondMaster 600 Stand

The BondMaster 600 features an articulating stand for variable viewing angles (see Figure 2-23 on page 57). The stand is attached to the back of the BondMaster 600 with two hard pivot blocks. There is a high-friction coating on the stand surface to help prevent it from sliding. The stand is bent in the center to easily accommodate being placed on a curved surface.

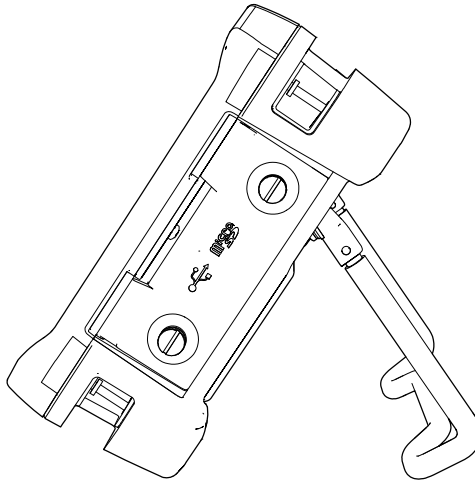

Figure 2-23 BondMaster 600 stand

2.5.3.2 O-Ring Gasket and Membrane Seals

The BondMaster 600 contains seals that protect the instrument's internal hardware from the environment:

- Battery compartment cover seal
- I/O door seal
- Membrane vent

These seals must be properly maintained to assure environmental durability. BondMaster 600 seals are evaluated and replaced as needed during the annual calibration. This should be performed at an authorized Evident service center.

2.5.3.3 Display Protection

The BondMaster 600 includes a clear plastic sheet protecting the display window. Evident strongly recommends leaving this protection sheet in place. Replacements are available in packages of ten sheets (Evident P/N: 600-DP [U8780297]).



CAUTION

The display window is permanently bonded to the instrument case to fully seal the BondMaster 600. If the display window becomes damaged, the front part of the case must be replaced, along with the keypad.

2.5.4 Environmental Ratings

The BondMaster 600 is an extremely rugged and durable instrument that can be used in harsh environments. To classify the instrument's durability in wet or damp environments, Evident has adopted the IP (International Protection) ingress rating system to indicate how well the instrument is sealed.

The BondMaster 600 has been tested to the requirements of IP66. The BondMaster 600 is designed and manufactured to meet this level of ingress protection when it leaves the factory. To maintain this level of protection, you are responsible for the proper care of all routinely exposed membrane seals. Additionally, you are responsible for returning the BondMaster 600 to an authorized Evident service center each year to ensure that the BondMaster 600 seals are properly maintained. Evident cannot guarantee any level of ingress protection performance if the BondMaster 600 seals have been manipulated. You must use sound judgment and take proper precautions before exposing the BondMaster 600 to harsh environments.

The BondMaster 600 adheres to the environmental standards listed in Table 6 on page 217.

3. Software User Interface

This chapter explains the main software screens and menus on the BondMaster 600 composite bond tester. The back of the BondMaster 600 contains a quick guide to the instrument keypad and functions (see Figure 3-1 on page 59).

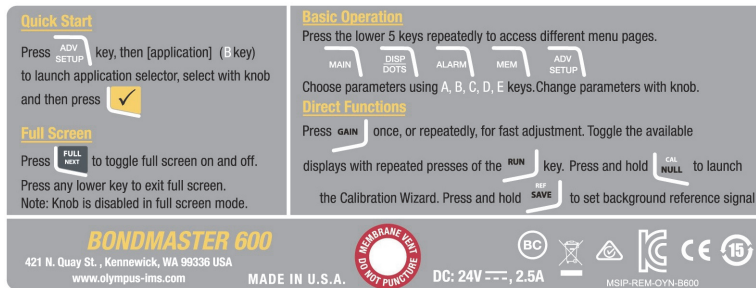

Figure 3-1 The BondMaster 600 label showing keypad functions

3.1 Starting Up the BondMaster 600

When power is turned on, the BondMaster 600 starts up in one of two modes, depending on what is connected to the instrument:

- If no probe is connected or a probe that is not a PowerLink type of probe is connected, the first screen displayed by the BondMaster 600 software is the application quick-setup menu (see Figure 3-2 on page 60). Choose from among the basic applications on this menu to automatically configure the appropriate instruments settings.

- If a PowerLink probe is connected, the BondMaster 600 starts up in the PowerLink recognition screen (see Figure 3-3 on page 60), which lets you automatically set up the instrument for that type of probe.

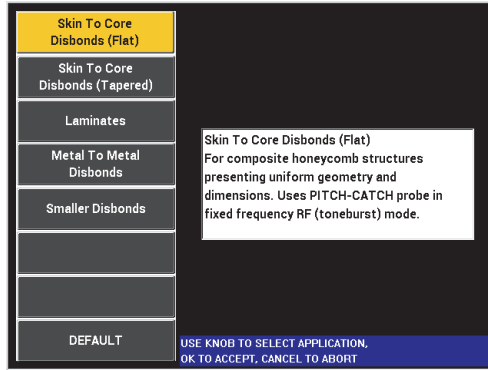

Figure 3-2 Application choices on the quick-setup menu

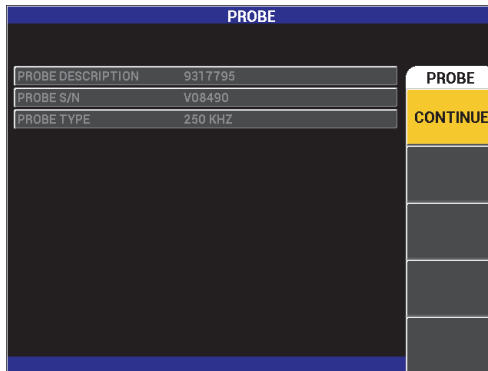

Figure 3-3 The PowerLink recognition screen

NOTE

The BondMaster 600 applications are designed for quick setup of the instrument. However, always follow published maintenance procedures when inspecting.

3.1.1 Navigating the Application Menu

Menu navigation is designed to be intuitive, and the settings for each application enable immediate inspection; little or no additional instrument setup is needed.

To navigate the application menu

1. Rotate the knob to highlight one of the applications.
2. Press the Enter key (✓) to select the application.

OR

Press the Return key (↻) to go back to the BondMaster 600 main screen.

To navigate the application menu for PowerLink

- ◆ If a PowerLink probe is connected and the PowerLink recognition screen is displayed (see Figure 3-3 on page 60), load the program stored in the PowerLink probe, and automatically set up the BondMaster 600, by pressing the A key.

OR

Bypass the stored program in the probe and gain access to the BondMaster 600 main inspection screen by pressing the Return key (↻).

3.1.2 Main Inspection Screen

After the initial steps are completed through the quick-setup menu or PowerLink menu, the main inspection screen is displayed (see Figure 3-4 on page 62).

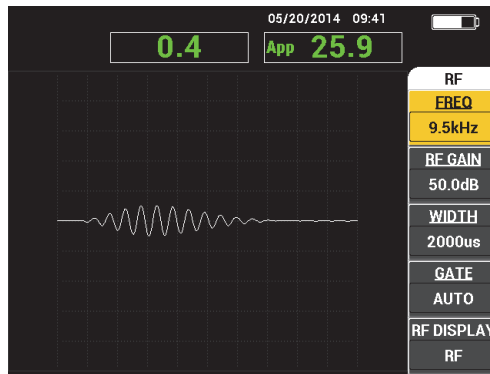

Figure 3-4 The main inspection screen

NOTE

Figure 3-4 on page 62 contains a typical example of the main inspection screen. The screen's appearance may vary, depending on the application that is chosen or the PowerLink application (program) that is loaded (see Figure 3-2 on page 60 and Figure 3-3 on page 60).

The battery power indicator remains visible at the top of the screen, except when in full-screen mode (see Table 1 on page 40 for details). The time and date also remain visible, except when in full-screen mode.

The rectangular readout in the top-left corner of the screen is named the quick-access bar (see Figure 3-5 on page 63). When the GAIN direct function key (**dB**) is pressed, the quick-access bar displays one of the following options:

- The combined horizontal and vertical gain settings
- The horizontal gain only
- The vertical gain only

The quick-access bar remains visible until any other key is pressed.

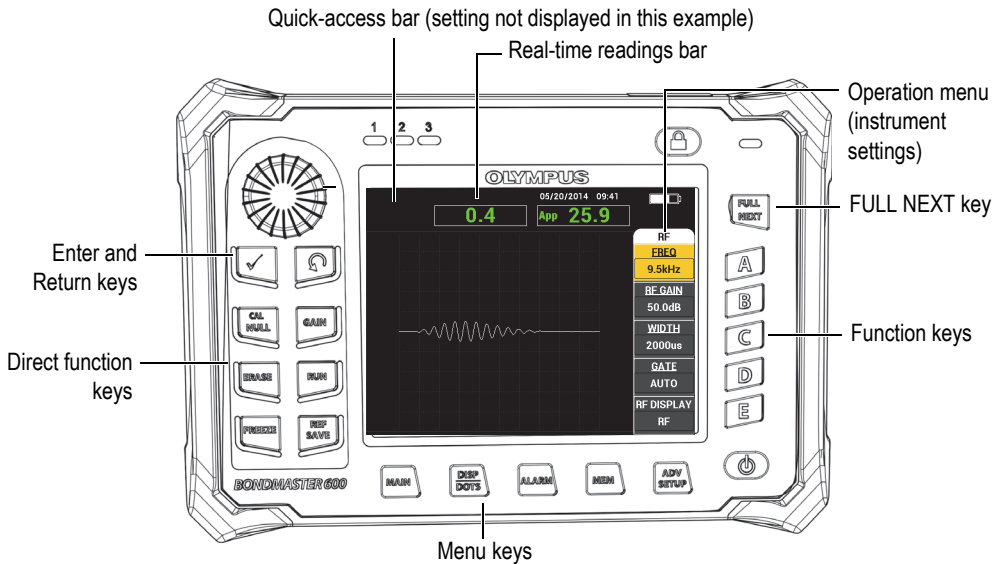

Figure 3-5 The BondMaster 600 front panel and main inspection screen

The real-time readings bar displays user-configurable readings (measurements) [see Figure 3-5 on page 63]. It can display a maximum of two real-time readings from among the available choices. The real-time readings bar can be set to display one or two readings, or it can be disabled. For more information, see “Displaying Real-Time Readings” on page 66.

The BondMaster 600 settings are displayed on the right hand side of the main screen. The displayed settings information can change, depending on the menu key that is pressed.

3.2 Selecting from the Menu

The BondMaster 600 menu keys at the bottom of the front panel are MAIN (📶), DISP/DOTS (⏏), ALARM (🔔), MEM (📁), and ADV SETUP (⚙️). When one of these keys is pressed, the operation menu appears at the right-hand side of the

screen (see Figure 3-5 on page 63). Depending on the application, if a menu key is pressed again, a secondary menu can be displayed with the parameters available for that key.

To select from a menu

1. Press one of the menu keys located at the bottom of the front panel to display a menu: MAIN (📶), DISP/DOTS (◻), ALARM (🔔), MEM (📁), or ADV SETUP (⚙️).

Pressing the same menu key again will cycle through the available options and update the available parameters, which can then be adjusted.

2. Select the parameter to be changed by pressing the function key (A, B, C, D, or E) located next to it.

Rotating the knob changes the parameter's value. The value selected with the knob is automatically entered (and saved); you do not have to use the Enter key.

3.3 Displaying All Parameters Simultaneously—ALL SETTINGS Menu

As an alternative to the operation menu, the BondMaster 600 has the option of displaying all parameters simultaneously using the **ALL SETTINGS** menu. The **ALL SETTINGS** menu consists of three main elements: the title bar, the parameters, and the help text (see Figure 3-6 on page 64).

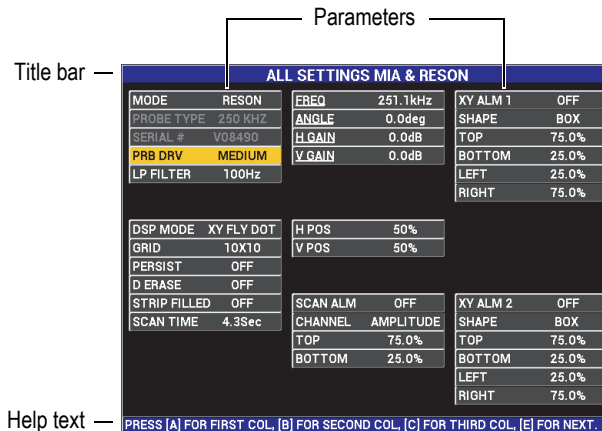







Figure 3-6 The ALL SETTINGS menu

3.3.1 Using the ALL SETTINGS Menu

The **ALL SETTINGS** menu is accessed through the ADV SETUP menu key ()

To use the ALL SETTINGS menu

1. Press the ADV SETUP menu key ()
 2. Press the B key.
 3. Press the FULL NEXT key () to select the parameter to be adjusted.
 4. Rotate the knob to select the desired value.
 5. Press the FULL NEXT key () to select additional parameters to be adjusted.
- OR

Press  to exit the menu and return to the previous screen.

NOTE

Because of the large number of parameters that are available on the BondMaster 600, the **ALL SETTINGS** menu contains multiple screens, or pages. The help text at the bottom of the menu provides any additional navigation options that may be needed.

3.3.2 Special Functions in the ALL SETTINGS Menu

Two special instrument functions are found only in the **ALL SETTINGS** menu: **EXT HORN** (external horn) and **AOUT PWR** (analog out power). These functions enable the output connectors on the back of the BondMaster 600 (see Figure 2-21 on page 54). To enable these functions, follow the instructions in “Using the ALL SETTINGS Menu” on page 65.

NOTE

If the BondMaster 600 is being used in noisy conditions, an external horn can be used. The horn connects to the I/O connector on the back of the BondMaster 600 and increases the audible alarm's sound output to 70 dB (see Table 6 on page 217 for the part specification).

3.4 Displaying Real-Time Readings

The real-time readings bar displays user-configurable readings (measurements) [see Figure 3-5 on page 63]. It can display a maximum of two real-time readings from among the available choices—the number of available choices depends on the selected operating mode. The real-time readings bar can be set to display one or two readings, or it can be disabled.

The real-time readings bar can display the following readings (see Figure 3-7 on page 67 and Figure 3-8 on page 67):

- **LIVE AMPL** — Maximum distance between current XY (horizontal, vertical) dot position (swept mode excluded) and null position.
- **LIVE VERT** — Maximum distance between current vertical (Y) dot position (swept mode excluded) and null position.
- **LIVE HORZ** — Maximum distance between current horizontal (X) dot position (swept mode excluded) and null position.
- **LIVE ANGL** — Angle of current XY position with respect to the null point (swept mode excluded).
- **AMPLITUDE P-P** — Volts peak-to-peak or largest signal (swept mode only).

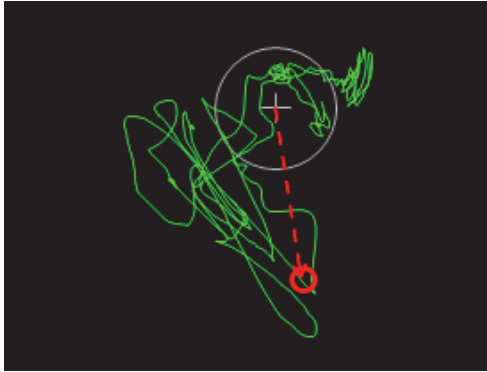

Figure 3-7 Example of LIVE AMPL, LIVE VERT, LIVE HORZ, and LIVE ANGL

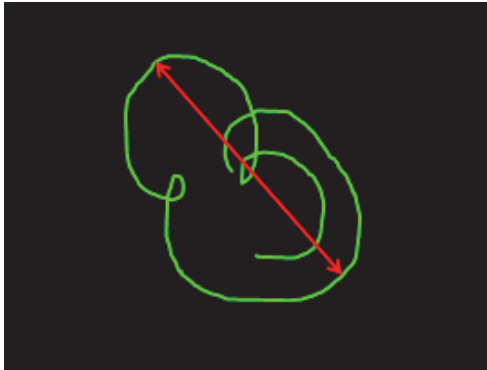



Figure 3-8 Example of VOLTS P-P

3.4.1 Enabling Real-Time Readings on the Main Inspection Screen

The real-time readings are enabled through the ADV SETUP menu key (➔ .

To enable the real-time readings bar on the main inspection screen

1. Press the ADV SETUP menu key (➔ .
2. Press the B key.

3. Press the C key.
4. Press the FULL NEXT key () to navigate to the desired type and/or location.

NOTE

Only **TOP LEFT** and **TOP RIGHT** are valid locations for the real-time readings on the main inspection screen. For available locations in full-screen mode, see “Enabling Real-Time Readings in Full-Screen Mode — FULL NEXT Key” on page 68.

5. Rotate the knob to make a selection.
6. Press the FULL NEXT key () to navigate to another type and/or location.
OR

Press the Return key () to exit.

3.4.2 Enabling Real-Time Readings in Full-Screen Mode — FULL NEXT Key

The real-time readings are also available in full-screen mode, which can be accessed using the FULL NEXT key () shown in Figure 3-5 on page 63. The location of displayed readings on the full screen differs from the location on the main inspection screen. The location and the type of reading is user-selectable.



Valid (possible) locations for the real-time readings in full-screen mode are: **TOP LEFT**, **TOP CNTR** (top center), **TOP RIGHT**, **LEFT**, **RIGHT**, **BOT LEFT** (bottom left), or **BOT CNTR** (bottom center).

NOTE

The performance and results of the real-time readings are greatly affected by the **D ERASE** (display erase) and **PERSIST** (persistence) settings. It is recommended to experiment with these parameters.

To enable the real-time readings in full-screen mode (FULL NEXT key)

1. Press the ADV SETUP menu key ()

2. Press the B key.
 3. Press the E key.
 4. Press the B key.
 5. Press the FULL NEXT key () to navigate to the desired type and/or location.
 6. Rotate the knob to make a selection.
 7. Press the FULL NEXT key () to navigate to another type and/or location.
- OR

Press the Return key () to exit.

4. Initial Setup

This chapter contains the basic configurations for the BondMaster 600 composite bond tester.

4.1 Setting the User Interface Language and Decimal Symbol

You can configure the BondMaster 600 to present the user interface in the following languages: English, French, Spanish, German, Japanese, Chinese, Russian, Swedish, Italian, Portuguese, Norwegian, Hungarian, Polish, Dutch, and Czech. You can also change the character that represents the decimal of a number.

To change the user interface language and decimal symbol

1. Press the ADV SETUP menu key () twice, and then press the B key to access the **SYSTEM SETUP** screen (see Figure 4-1 on page 72).

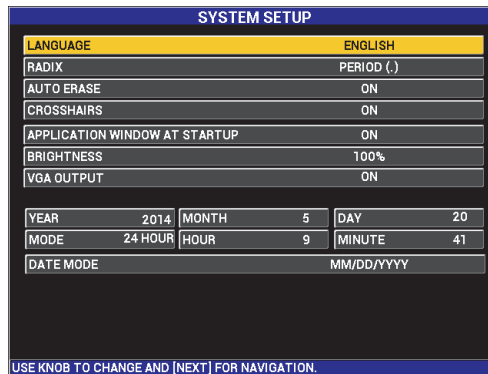





Figure 4-1 The SYSTEM SETUP screen



- In the **SYSTEM SETUP** screen, press the FULL NEXT key () until **LANGUAGE** is highlighted.
- Using the knob, choose the desired language.
- Press the FULL NEXT key () until **RADIX** is highlighted.
- Using the knob, choose the desired character to represent the decimal of numbers: **PERIOD (.)** or **COMMA (,)**.
- Press  to return to the main inspection screen.

4.2 Setting the Clock

The BondMaster 600 has a built-in date and time clock. You can set the date and the time, and select their respective format. The BondMaster 600 saves all inspection results with their acquisition date.

To set the clock



- Press the ADV SETUP menu key () twice, and then press the B key to access the **SYSTEM SETUP** screen (see Figure 4-1 on page 72).
- Set the **YEAR**, **MONTH**, **DAY**, **MODE** (**12 HOUR** or **24 HOUR**), **HOUR**, **MINUTE**, and **DATE MODE** as follows:

- a) Press the FULL NEXT key () until the item (**YEAR, MONTH, DAY** etc.) is highlighted.
 - b) Rotate the knob until the correct value is displayed.
3. Press  to return to the main inspection screen.

4.3 Changing the Display Settings

You can change the appearance of some display elements such as brightness, auto erase, VGA output, and the application window (or screen) at startup.

To change the display settings

1. Press the ADV SETUP menu key () twice.
2. Press the B key to access the **SYSTEM SETUP** screen.
3. In the **SYSTEMS SETUP** screen (see Figure 4-1 on page 72), use the FULL NEXT key () to highlight the desired parameter and then use the knob to change its value:
 - a) Set **BRIGHTNESS** to one of the predefined brightness levels: **0 %**, **25 %**, **50 %**, **75 %**, or **100 %** (see “Changing the Display Brightness” on page 73 for more details on brightness).
 - b) Set **VGA OUTPUT** to **ON** or **OFF**.
 - c) Set **AUTO ERASE** to **ON** or **OFF** (see “Adjusting Auto Erase” on page 74 for details).
 - d) Set **APPLICATION WINDOW AT STARTUP** to **ON** or **OFF** (see “Selecting the Startup Screen” on page 75 for more details).
4. Press  to return to the main inspection screen.

4.4 Changing the Display Brightness

You can adjust the BondMaster 600 display brightness by changing the backlight intensity. The display brightness can be set at 0 %, 25 %, 50 %, 75 %, or 100 %. Choosing a high percentage increases the brightness of the display. By default, the

display brightness is set to 50 %. The transfective color display of the BondMaster 600 reflects ambient light and becomes brighter in direct light. With brighter ambient conditions, you can set the display **BRIGHTNESS** to a lower percentage.

To change the display brightness

1. Press ADV SETUP twice, then press the B key to enter the **SYSTEM SETUP** screen and press FULL NEXT until **BRIGHTNESS** is highlighted.
2. Using the knob, select the desired **BRIGHTNESS** percentage: **0 %**, **25 %**, **50 %**, **75 %**, or **100 %**.
3. Press  to return to the main inspection screen.



NOTE

Reducing the display **BRIGHTNESS** percentage increases the battery life. Battery life specifications are based on backlight **BRIGHTNESS** set to **50 %**.

4.5 Adjusting Auto Erase

You can adjust the BondMaster 600 to clear (erase) the screen contents automatically after the CAL NULL key () is pressed. By default, the **AUTO ERASE** is set to **ON**, but it can be disabled by selecting **OFF**.



To adjust Auto Erase

1. Press the ADV SETUP menu key () twice, then press the B key to enter the **SYSTEM SETUP** screen and press the FULL NEXT key () until **AUTO ERASE** is highlighted.
2. Use the knob to disable (select **OFF**) or enable (select **ON**) the **AUTO ERASE**.
3. Press  to return to the main inspection screen.

4.6 Selecting the Startup Screen

You can adjust the BondMaster 600 to automatically display the **APPLICATION MENU** screen after it is turned on. This function can also be disabled, so that the BondMaster 600 will instead display the main inspection screen. By default, the **APPLICATION WINDOW AT STARTUP** function is set to **ON**.



To select the startup screen

1. Press the ADV SETUP menu key () twice, then press the B key to enter the **SYSTEM SETUP** screen and press the FULL NEXT key () until **APPLICATION WINDOW AT STARTUP** is highlighted.
2. Use the knob to disable (select **OFF**) or enable (select **ON**) this function.
3. Press  to return to the main inspection screen.

4.7 Activating the Crosshairs

You can set the BondMaster 600 to display crosshairs to better highlight the position of the null (see Figure 4-2 on page 76). Crosshairs are available only for XY screens (with or without split screen), but functions in ALL modes.

To activate the crosshairs function

1. Press the ADV SETUP menu key () twice, then press the B key to enter the **SYSTEM SETUP** screen and press the FULL NEXT key () until **CROSSHAIRS** is highlighted.
2. Use the knob to disable (select **OFF**) or enable (select **ON**) the **CROSSHAIRS**.
3. Press  to return to the main inspection screen.

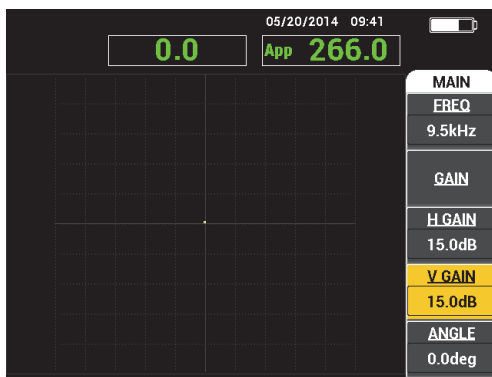

Figure 4-2 Crosshairs and the NULL point

5. Control Functions

This chapter provides explanations of the control functions on the BondMaster 600 composite bond tester.

5.1 PowerLink

The PowerLink feature enables the BondMaster 600 to automatically recognize Evident PowerLink BondMaster probes when they are connected to the instrument. The BondMaster 600 is then configured according to the parameters programmed into the PowerLink ID chip. Each PowerLink probe is programmed at the factory to provide its model number, preselected operating frequency, gain, and serial number.

When a PowerLink probe is connected, the BondMaster 600 displays the PowerLink recognition screen (see Figure 5-1 on page 77).

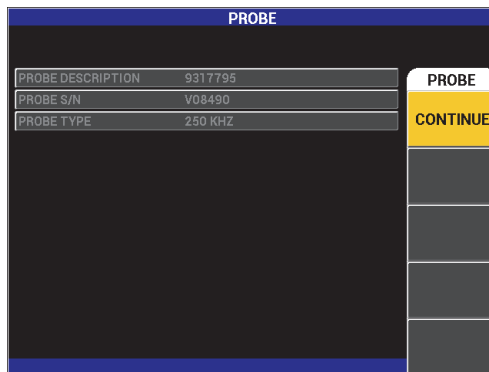



Figure 5-1 PowerLink recognition screen

At this point, if the PowerLink function has been enabled, the settings will be loaded into the BondMaster 600. If the Powerlink function has been disabled, this screen will be bypassed. In either case, the BondMaster 600 will next proceed to the main inspection screen.

If you turn on the BondMaster 600 with a connected PowerLink probe, press the A key to use the PowerLink feature, or press  to proceed without using the PowerLink feature.

5.2 BondMaster 600 Controls

The BondMaster 600 controls are displayed in Figure 5-2 on page 78.

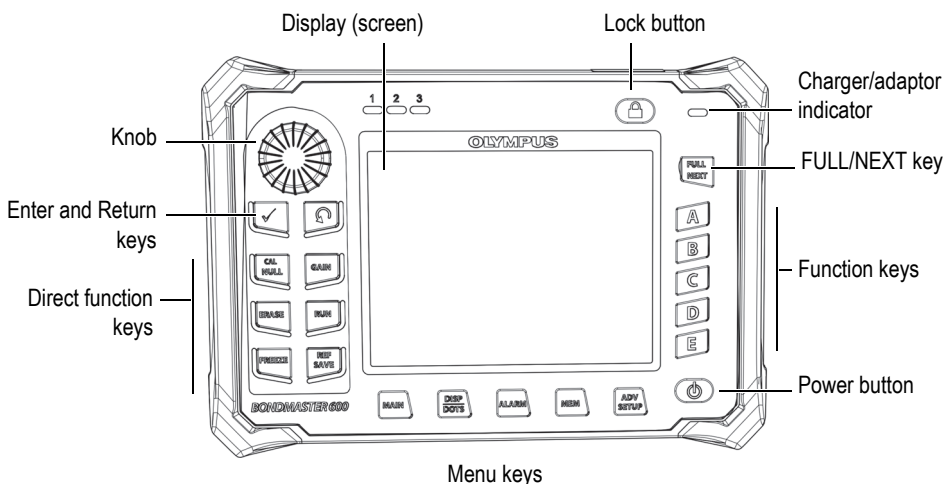





Figure 5-2 The BondMaster 600 controls





5.2.1 Display

The BondMaster 600 is configured with a color liquid crystal display (LCD) and offers 640 × 480 resolution (full VGA). The LCD display, also referred to as a screen, shows the probe signal, menus, status bar, messages, and full screen text when required. Several display modes are available. The display mode, also referred to as RUN, can be changed using the RUN menu key (.

5.2.2 Power and Lock Buttons

The power button () toggles the BondMaster 600 power on and off. At startup, the BondMaster 600 will normally attempt to restore its last configuration.

The BondMaster 600 lock can be enabled or disabled by pressing the lock button (). When activated, the lock disables most of the BondMaster 600 direct function keys, function keys (A, B, C, D, and E), menu keys, and the knob. This prevents inadvertent key entries after the BondMaster 600 is calibrated and inspections are ready to proceed.

When the lock is activated, an indicator light illuminates below the battery life indicator (at the upper right side of the BondMaster 600), and only the CAL NULL ()^{CAL}, ERASE ()^{ERASE}, FREEZE ()^{FREEZE}, and REF SAVE ()^{REF} direct function keys remain functional. If any locked functions are attempted, the error message **Parameter Locked** will appear at the bottom of the screen.

5.2.3 Function Keys

The function keys located on the right side of the BondMaster 600 are used to select instrument parameters for adjustment. When a function key is pressed, the parameter located in the box displayed directly beside that key (A, B, C, D, or E) is highlighted.

5.2.4 Menu Keys

The menu keys located at the bottom of the BondMaster 600 display are used for direct selection of instrument menus. Each of the menu keys provides access to two or more submenus. Repeated pressing of a menu key toggles between the menus. Pressing the function key (A, B, C, D or E) next to a menu item enables modification of the item or access to additional menus or submenus.

The following menu keys are available:

MAIN ()

Provides access to the main menu, which controls functions such as frequency, gain, angle, and filters.

DISP/DOTS ()

Provides access to the display menu, which controls functions such as display mode, position, trace, and grid.

ALARM ()

Provides access to the alarm menu, which controls functions such as alarm type, dwell time, horn volume, and alarm position.

MEM ()

Provides access to the memory menu, which controls functions such as previewing stored memory files, recalling and editing stored files, capture mode, capture time, and user information.



ADV SETUP ()

Provides access to the **ALL SETTINGS** setup menu which controls BondMaster 600 setup parameters such as frequency mode, colors, password, unlock options, and reset. This menu displays all BondMaster 600 settings at the same time.

5.2.5 SmartKnob

This rotating knob, called the SmartKnob, is located in the upper left-hand side of the BondMaster 600. Its primary purpose is to adjust the selected BondMaster 600 parameter. When the box of the parameter being adjusted is highlighted, rotating the knob clockwise increases the value and rotating it counterclockwise decreases the value. In some cases, the knob may also be used to respond to various prompts from the BondMaster 600.

5.2.6 Hidden Function — Screen Capture

On the BondMaster 600 instrument, you can send a screen-capture image file to the removable (external) microSD card by holding the MAIN menu key ()^{REF}, and then pressing the REF SAVE key (). Alternatively, you can use the BondMaster PC software to capture a screen image (see “Screen Capture Using BondMaster PC” on page 181).

5.3 Modes and Menus

The BondMaster 600 menus described in this section are opened by pressing the corresponding menu keys, which are described in “Menu Keys” on page 79.

NOTE

The BondMaster 600 menus vary, depending on the following:

- The mode of operation; and,
- The RUN function, or display mode.

Therefore, the two master controls, MODE and RUN, determine what is displayed on the menus.

5.3.1 PC RF Mode — MAIN Menu

The pitch-catch (PC) mode RF DISPLAY is similar to that of the impulse mode. However, the data displayed is the raw amplified signal from the probe, and this data is not processed by the instrument (see Figure 5-3 on page 81).

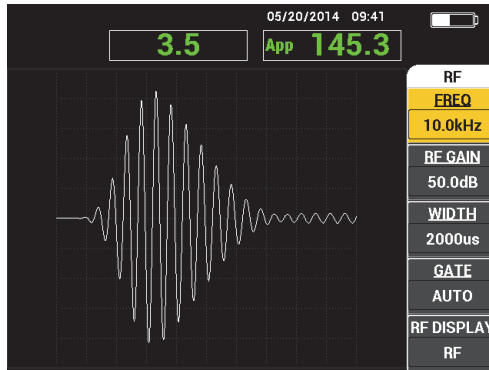

Figure 5-3 The RF DISPLAY

The following parameters can be adjusted on the PC (RF) main menu (see Figure 5-4 on page 82):

- **FREQ** (frequency)
- **RF GAIN**
- **WIDTH**
- **GATE**
- **RF DISPLAY**
- **CYCLES**
- **H/V GAIN** (horizontal/vertical gain)
- **H GAIN** (horizontal gain)
- **V GAIN** (vertical gain)
- **ANGLE**
- **REP RATE** (repetition rate)
- **PRB DRV** (probe drive)
- **LP FILTER** (low pass filter)

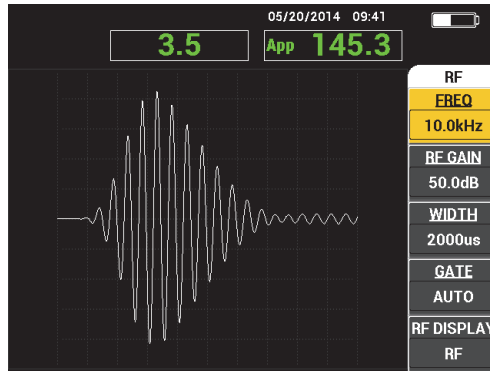



Figure 5-4 The PC (RF) main menu

Changing Parameters in the PC (RF) Main Menu

NOTE



The following information is applicable when the BondMaster 600 mode is set to PC (RF) and the MAIN menu key () has been pressed.

FREQ (frequency)

The **FREQ** (frequency) setting determines the frequency of the tone burst. This is adjustable from 1 kHz to 50 kHz.

To change the **FREQ** setting, press the A key, and then rotate the knob to the desired frequency.

TIP

Press the Enter key () once, while the **FREQ** parameter is highlighted, to enable the fine knob function, which decreases the frequency selection increments from 1.0 (coarse) to 0.1 (fine) increments. By default, the knob adjustment is set to coarse increments, and **FREQ** is underlined when the coarse knob function is enabled. To turn the coarse knob function back on, press  one more time.

RF GAIN

The **RF GAIN**, or vertical gain, setting controls the gain of the tone burst signal. This is adjustable from 0.0 dB to 70.0 dB.

The **RF GAIN** is the master gain setting, and it should be always be adjusted first when a gain change is desired.

To change the **RF GAIN** setting, press the B key, and then rotate the knob to the desired gain value.

WIDTH

The **WIDTH** setting controls the amount of time displayed after the beginning of the tone burst that is displayed on the Y (amplitude) versus T (time display).

To change the **WIDTH** setting, press the C key, and then rotate the knob to the desired width value.

GATE

The **GATE** setting controls the position on the **RF DISPLAY** where the XY flying dot display is computed. The **GATE** position determines the signal amplitude and phase on the XY display. To obtain the best results, set the **GATE** to the left of the first maximum peak on the **RF DISPLAY**, or on its maximum peak. The **AUTO** gate setting will automatically read the value for the maximum signal position.

To change the **GATE** setting, press the D key, and then rotate the knob to the desired gate value.

RF DISPLAY

The **RF DISPLAY** setting controls the display and can be set to **RF** or **IMPULSE** mode. (The name “**IMPULSE**” originates from earlier products.) The **IMPULSE** display uses an envelope filter that is applied over the RF filter.

To change the **RF DISPLAY** setting, press the E key, and then rotate the knob to the desired value.

CYCLES

The **CYCLES** setting is used to control the number of cycles of the signal in the tone burst in the PC **RF** and **IMPULSE** display modes, and is adjustable between 1 and 10.

To change the **CYCLES** setting, press the MAIN menu key () followed by the A key, and then rotate the knob to the desired number of cycles.

H/V GAIN (horizontal/vertical gain)

The **H/V GAIN** setting applies to display modes (RUNs) that use the XY display. This parameter allows separate control of the horizontal and vertical gain on the XY display.

To change the **H/V GAIN**, press the MAIN menu key () once or twice (depending on the RUN selected), followed by the B key, and then rotate the knob to the desired value.

H GAIN (horizontal gain)

The **H GAIN** setting controls the horizontal (X) gain, and applies to RUNs using an XY display.

To change the **H GAIN**, press the MAIN menu key () once or twice (depending on the RUN selected), followed by the C key, and then rotate the knob to the desired value.

V GAIN (vertical gain)

The **V GAIN** setting controls the vertical (Y) gain, and applies to RUNs using an XY display.

To change the **V GAIN**, press the MAIN menu key () once or twice (depending on the RUN selected), followed by the D key, and then rotate the knob to the desired value.

ANGLE

The **ANGLE** setting only applies to RUNs that use an XY display. This parameter permits rotational control of the signals that appear in the XY display. This parameter is useful, for example, if you want the angle for a far-side disbond (defect) to be different from the angle for a near-side disbond.

To change the **ANGLE**, press the MAIN menu key () once or twice (depending on the RUN selected), followed by the E key, and then rotate the knob to the desired value.

REP RATE (repetition rate)

The **REP RATE** (repetition rate) setting controls the repetition rate of the tone burst.

To change the **REP RATE** setting, press the MAIN menu key () followed by the C key, and then rotate the knob to the desired repetition rate.

PRB DRV (probe drive)

The BondMaster 600 has three levels of probe drive: **LOW**, **MEDIUM**, and **HIGH**. The approximate peak-to-peak voltages are 2 V, 6 V, and 12 V, respectively.

To adjust the probe-drive level, press the MAIN menu key () two times, followed by the D key. With **PRB DRV** highlighted, rotate the knob to the desired level.

LP FILTER

The **LP FILTER** setting only applies to RUNs that use an XY display. Adjust this parameter to smooth the signal in the XY display.

To change the **LP FILTER**, press the MAIN menu key () two or three times (depending on the RUN selected), followed by the E key, and then rotate the knob to the desired value.

5.3.2 PC Swept Mode — MAIN Menu

In pitch-catch (PC) swept mode, the probe is excited by a signal that is swept from a specified starting and ending frequency. The displayed signal represents the excitation frequency that is swept (see Figure 5-5 on page 86).

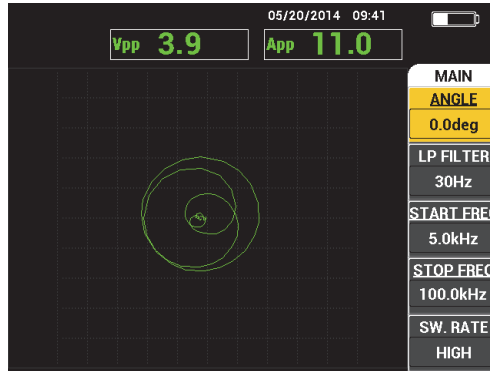



Figure 5-5 The PC Swept display

The following parameters can be adjusted on the PC Swept main menu:

- **ANGLE**
- **GAIN (H/V GAIN)**
- **START FREQ** (start frequency)
- **STOP FREQ** (stop frequency)
- **SW. RATE** (swept rate)
- **FRQ1 TRACK** (frequency 1 tracking)
- **FRQ2 TRACK** (frequency 2 tracking)
- **H GAIN** (horizontal gain)
- **V GAIN** (vertical gain)
- **PRB DRV** (probe drive); for details, see “PC Swept Mode — MAIN Menu” on page 86

Changing the Parameters in the PC Swept Main Menu

NOTE

The following information is applicable when the BondMaster 600 is set to PC Swept mode and the MAIN menu key () has been pressed.

ANGLE

The **ANGLE** setting controls the rotation of the display signal.

To change the **ANGLE** setting, press the A key, and then rotate the knob to the desired angle value.

GAIN (H/V GAIN)

The **GAIN** setting controls the overall gain of the signal.

To change the **GAIN** setting, press the MAIN menu key () once, then press the B key and rotate the knob to the desired setting.

START FREQ (start frequency)

The **START FREQ** (start frequency) setting controls the swept frequency starting point (value).

To change the **START FREQ** setting, press the C key, and then rotate the knob to the desired start frequency value.

STOP FREQ (stop frequency)

The **STOP FREQ** (stop frequency) setting controls the swept frequency ending point (value).

To change the **STOP FREQ** setting, press the D key, and then rotate the knob to the desired stop frequency value.

SW. RATE (swept rate)

The **SW. RATE** (swept rate) setting controls the swept rate and can be set to one of the following options: **LOW**, **MEDIUM**, or **HIGH**.

To change the **SW. RATE** setting, press the E key, and then rotate the knob to the desired swept rate value.

FRQ1 TRACK (frequency 1 tracking)

The **FRQ1 TRACK** (frequency 1 tracking) parameter is set to **OFF** by default. To change the **FRQ1 TRACK** setting, press the MAIN menu key () followed by the A key, and then rotate the knob to the desired frequency 1 tracking value. This control is only available when the display is set to **SPEC+XY** or **SPECTRUM**, and it is easier to work with in the **SPEC+XY RUN**. To properly adjust the **FRQ1 TRACK** setting:

1. Scan a patch of good material, and adjust gain as needed to avoid signal saturation.
2. Scan over the bad area, and observe the **SPECTRUM** view.
3. Locate the area where there seems to be the greatest difference between the results of the scan over the good area and the scan over the bad area. Move the **FRQ1 TRACK** marker to this position.

FRQ2 TRACK (frequency 2 tracking)

The **FRQ2 TRACK** (frequency 2 tracking) parameter is set to **OFF** by default. To change the **FRQ2 TRACK** setting, press the MAIN menu key () followed by the B key, and then rotate the knob to the desired frequency 2 tracking value. This control is only available when the display is set to **SPEC+XY** or **SPECTRUM**, and it is easier to work with in the **SPEC+XY RUN**. To properly adjust the **FRQ2 TRACK** setting:

1. Scan a patch of good material, and adjust gain as needed to avoid signal saturation.
2. Scan over the bad area, and observe the **SPECTRUM** view.
Locate the area where there seems to be the greatest difference between the results of the scan over the good area and the scan over the bad area. Move the **FRQ2 TRACK** marker to this position.

NOTE

The frequency tracking function is used to develop applications and create procedures. This function tracks up to two user-defined frequencies and displays a persistent trace in the XY plane, recording the position of a given frequency from the pitch-catch swept signal. The frequency tracking function only works in pitch-catch mode. Typically, this function works best with the **SWEPT RATE** set to **LOW**, and by narrowing the **START** and **END** frequency range of the swept figure to the range of frequencies that are of interest.

H GAIN (horizontal gain)

The **H GAIN** (horizontal gain) setting controls the BondMaster 600 horizontal gain.

To change the **H GAIN** setting, press the MAIN menu key () followed by the C key, and then rotate the knob to the desired horizontal gain value.

V GAIN (vertical gain)

The **V GAIN** (vertical gain) setting controls the BondMaster 600 vertical gain.

To change the **V GAIN** setting, the MAIN menu key () followed by the D key, and then rotate the knob to the desired vertical gain value.

5.3.3 MIA Mode — MAIN Menu

In the mechanical impedance analysis (MIA) mode, a frequency sweep with the probe on a good part is compared to the frequency sweep of the probe on a defective part. This determines a suitable frequency for performing the test (see Figure 5-6 on page 89).

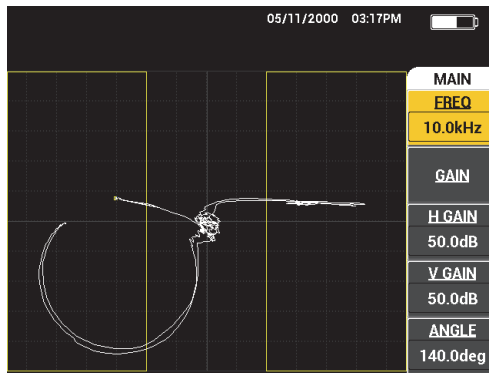

Figure 5-6 The MIA Mode Display

The following parameters can be adjusted on the MIA MAIN menu:

- **FREQ** (frequency)
- **GAIN** (combined)
- **H GAIN** (horizontal gain)

- **V GAIN** (vertical gain)
- **ANGLE**
- **PRB DRV** (probe drive)
- **LP FILTER** (low pass filter)

Changing Parameters in the MIA Mode MAIN Menu

NOTE

For details on **GAIN**, **H GAIN**, **V GAIN**, and **PRB DRV** parameter adjustments, see “PC Swept Mode – MAIN Menu” on page 86. Parameter descriptions are based on the presumption that the BondMaster 600 is set to MIA mode and the MAIN menu key () has been pressed.

FREQ (frequency)

The **FREQ** (frequency) setting controls the frequency of the display signal.

To change the **FREQ** setting, press the A key, and then rotate the knob to the desired frequency value.

ANGLE

The **ANGLE** setting controls the angle of the display signal.

To change the **ANGLE** setting, press the E key, and then rotate the knob to the desired angle value.

LP FILTER (low pass filter)

The **LP FILTER** (low pass filter) setting may be set from 1 Hz to 480 Hz, plus wideband. The low pass filter is adjustable in 1 Hz increments up to 50 Hz, in 2 Hz increments up to 100 Hz, in 5 Hz increments up to 200 Hz, in 10 Hz increments up to 300 Hz and in 20 Hz increments up to 480 Hz, followed by wideband.

To adjust the **LP FILTER** settings, press the E key, and then rotate the knob to the desired low pass filter value.

5.3.4 RESON Mode — MAIN Menu

The RESON (resonance) mode uses a probe that is tuned to have a resonance at a particular frequency. When resonance mode is selected, a frequency sweep is done to determine the resonance frequency of the probe. The amplitude and phase of the sweep are displayed (see Figure 5-7 on page 91).

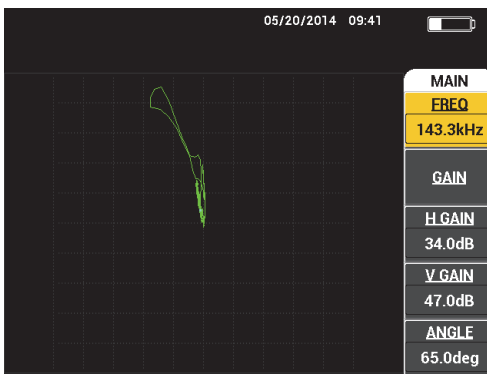



Figure 5-7 The resonance display

The following parameters can be adjusted on the RESON (resonance) MAIN menu:

- **FREQ** (frequency)
- **GAIN** (combined)
- **H GAIN** (horizontal gain)
- **V GAIN** (vertical gain)
- **ANGLE**
- **PRB DRV** (probe drive)
- **LP FILTER** (low pass filter)

Changing the Parameters in the RESON (Resonance) Mode MAIN Menu

NOTE

For parameter adjustment details, see “MIA Mode — MAIN Menu” on page 89. Parameter descriptions are based on the presumption that the BondMaster 600 is set to RESON mode and the MAIN menu key () has been pressed.

5.3.5 PC RF Mode — DISP/DOTS Menu

The **DISP/DOTS** (display/dots) menu allows you to change display options on the BondMaster 600 display.

The following parameters can be adjusted on the PC RF mode **DISP/DOTS** menu:

- **RUN**
- **CURSOR**
- **GRID**
- **POSITION**
- **H POS**
- **V POS**
- **STORE NEXT**
- **RE-WRITE DOT**
- **ERASE DOT**
- **ERASE ALL**
- **SET REF**
- **D ERASE**
- **PERSIST**
- **SCAN TIME**

Changing the Parameters in the PC RF DISP/DOTS (Display/Dots) Menu

NOTE

The following information is applicable when the BondMaster 600 is set to PC RF mode and the DISP/DOTS menu key () has been pressed.



RUN

The **RUN** setting controls the display mode that the probe is currently operating in (see Figure 5-8 on page 94).

To change the **RUN** setting, press the A key, and then rotate the knob to the desired setting.

NOTE

The **RUN** setting can also be accessed and changed by pressing the RUN direct function key () on the left-hand side of the BondMaster 600 front panel, underneath the knob.

Changing the RUN will also change the availability of functions in the menus accessed with the MAIN menu key () , DISP/DOTS menu key () , and ALARM menu key () .

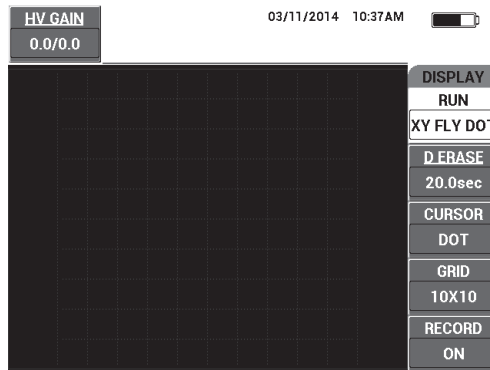

Figure 5-8 The RUN setting

CURSOR

The **CURSOR** setting controls whether a dot or box is displayed in the flying dot display.

To change the **CURSOR** setting, press the C key, and then rotate the knob to the desired cursor value.

GRID

The **GRID** setting controls the condition of the BondMaster 600 display grid. Five screen grid types are available: **OFF**, **10 × 10**, **FINE**, **COARSE**, and **WEB**. By default, the BondMaster 600 uses a 10 × 10 grid.

To adjust the grid setting, press the D key. With **GRID** highlighted, rotate the knob to the desired grid value.

OFF

The BondMaster 600 does not display a grid pattern.

10 × 10

A 10 by 10 grid pattern is displayed, with some unusable areas on the left and right sides of the screen.

FINE

A grid with 13 horizontal (centered) and 10 vertical divisions is displayed. The grid divisions furthest to the left and right are half the normal width.

COARSE

A grid with 6.5 horizontal (centered) and 5 vertical (centered) divisions is displayed. The grid divisions at the top and bottom are half the normal width, and grid divisions furthest to the left and right are one-quarter the normal width.

WEB

Provides a polar grid.

POSITION

The **POSITION** setting controls the null position of the flying dot on the instrument display. There are five preset null positions—**CENTER**, **BOT RGHT** (bottom right), **BOT CNTR** (bottom center), **TOP CNTR** (top center), and **TOP LEFT**—as well as a modifiable position named **CUSTOM**. By default, the null position is set at the center of the instrument display.

To adjust the null position, press the C key. With **POSITION** highlighted, rotate the knob until the desired position is displayed.

H POS

The **H POS** setting controls the null position of the flying dot in the horizontal axis when you are choosing a custom flying dot location.

To change the **H POS** setting, press the D key, and then rotate the knob to the desired horizontal position value.

V POS (vertical position)

The **V POS** setting controls the null position of the flying dot in the vertical axis when you are choosing a custom flying dot location.

To change the **V POS** setting, press the E key, and then rotate the knob to the desired vertical position value.

STORE NEXT

The **STORE NEXT** setting allows you to store dot positions on the BondMaster 600 display. When activated, **STORE NEXT** stores the dot location, along with a numerical value on the screen (see Figure 5-9 on page 96).

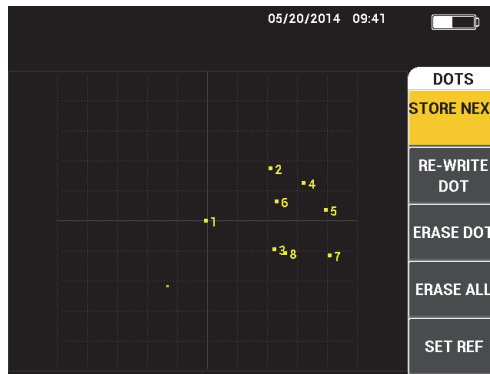

Figure 5-9 The stored dots

To store a dot position, press the A key. Press the A key repeatedly to store more dots.

RE-WRITE DOT

The **RE-WRITE DOT** setting allows you to rewrite a dot location, which is useful if an accidental button press has occurred.

NOTE

The **RE-WRITE DOT** function only allows you to rewrite the current dot location.

To rewrite a dot location, press the B key.

ERASE DOT

The **ERASE DOT** setting allows you to erase a dot location.

NOTE

The **ERASE DOT** function allows you to erase the current dot location.

To erase a dot location, press the C key. Press the C key repeatedly to erase dots one at a time, in the reverse order that they were written (stored) on the BondMaster 600 screen.

ERASE ALL

The **ERASE ALL** setting allows you to erase all dot locations.

To erase all dot locations, press the D key.

NOTE

Pressing **ERASE ALL** immediately erases all dot locations, which cannot be undone.

SET REF (set reference)

The **SET REF** (set reference) setting allows you to set a reference image for the BondMaster 600 display screen. This image is viewable after the erase button is pressed.

To set a reference image for the BondMaster 600 display screen, press the E key. Alternatively, the set reference parameter can be activated by pressing and

holding the REF SAVE direct function key () until an alert sound is heard.

D ERASE (display erase)

The **D ERASE** (display erase) setting controls how often the BondMaster 600 display is automatically erased. It is adjustable between zero (off) and 60 seconds, in 0.1 second increments (fine) by default. Alternatively, you can change the **D ERASE** adjustment to 1 second (coarse) increments by pressing the Enter key. When the coarse function is on, the **D ERASE** setting is underlined, as shown in Figure 5-10 on page 98.

To change the **D ERASE** setting, press the A key, and then rotate the knob to the desired display erase value.

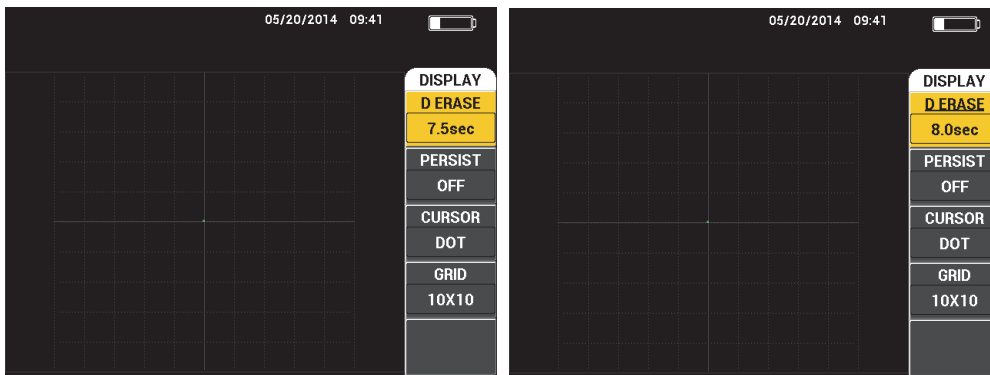

Figure 5-10 D ERASE fine (left) and coarse (right) functions

NOTE

The display erase function is not available if variable persistence (**PERSIST**) is activated.

PERSIST (variable persistence)

The **PERSIST** (variable persistence) setting enables automatic screen erase. You can set the display on an impedance plane (not sweep) so that the signal traces on the screen will be erased after a predetermined amount of time. This time may be set from 0.1 s to 10 s, in 0.1 s increments. By default, **PERSIST** is set to **OFF**.

To activate the variable persistence setting, press the B key. With the variable persistence setting highlighted, rotate the knob to adjust to the desired value.

SCAN TIME

Allows you to set the duration of RUNs that use the **SCAN** view.

To change the **SCAN TIME**, press the DISP/DOTS menu key () once, then press the E key, and use the knob to change the setting.

5.3.6 PC Swept Mode — DISP/DOTS Menu

The following parameters can be adjusted on the PC Swept DISP/DOTS (display/dots) menu:

- **RUN**
- **CURSOR**
- **GRID**
- **D ERASE**
- **RECORD**

NOTE

For details on **RUN**, **CURSOR**, **GRID**, and **D ERASE** parameter adjustments, see “PC RF Mode — DISP/DOTS Menu” on page 92. Parameter descriptions are based on the presumption that the BondMaster 600 is set to PC Swept mode and the DISP/DOTS menu key () has been pressed.

RECORD

The **RECORD** setting enable you to display frequency-tracking signal traces (up to two traces) during a **RUN** that uses the XY display.

To change the **RECORD** setting, press the DISP/DOTS menu key () twice, then press the E key, and then rotate the knob to adjust the setting.

5.3.7 MIA Mode — DISP/DOTS Menu

The following parameters can be adjusted on the MIA Mode DISP/DOTS (display/dots) menu:

- **RUN**
- **POSITION**
- **H POS** (horizontal position)
- **V POS** (vertical position)
- **STORE NEXT**
- **RE-WRITE DOT**
- **ERASE DOT**
- **ERASE ALL**
- **SET REF**
- **D ERASE** (display erase)
- **PERSIST**

- **CURSOR**
- **GRID**
- **SCAN TIME**

NOTE

For parameter adjustment details, see “PC RF Mode – DISP/DOTS Menu” on page 92. Parameter descriptions are based on the presumption that the

BondMaster 600 is set to MIA mode and the DISP/DOTS menu key () has been pressed.

5.3.8 RESON Mode — DISP/DOTS Menu

In RESON (resonance) mode, the following parameters can be adjusted on the DISP/DOTS (display and dots) menu:

- **RUN**
- **POSITION**
- **H POS** (horizontal position)
- **V POS** (vertical position)
- **STORE NEXT**
- **RE-WRITE DOT**
- **ERASE DOT**
- **ERASE ALL**
- **SET REF**
- **D ERASE** (display erase)
- **PERSIST**
- **CURSOR**
- **GRID**
- **SCAN TIME**

NOTE

For parameter adjustment details, see “PC RF Mode – DISP/DOTS Menu” on page 92. Parameter descriptions are based on the presumption that the

BondMaster 600 is set to RESON mode and the DISP/DOTS menu key () has been pressed.

5.3.9 PC RF Mode — ALARM Menu in RF RUN

The following parameters can be adjusted in the PC (RF) mode **ALARM** menu on RF RUN:

- **RF ALARM**
- **TOP**
- **BOTTOM**
- **DWELL**
- **HORN**

NOTE

The following information is applicable when the BondMaster 600 is set to PC (RF) mode and the ALARM menu key () has been pressed.

RF ALARM

The **RF ALARM** setting controls the RF alarm type and can be set to **OFF**, **POS** (positive), or **NEG** (negative).

To change the **RF ALARM** setting, press the A key, and then rotate the knob to the desired alarm type.

TOP

The **TOP** setting controls the alarm’s upper threshold. The displayed percentage is a percentage of the total screen height. An example of this control is shown in Figure 5-11 on page 102.

To change the **TOP** alarm threshold setting, press the B key, and then rotate the knob to the desired alarm threshold value.

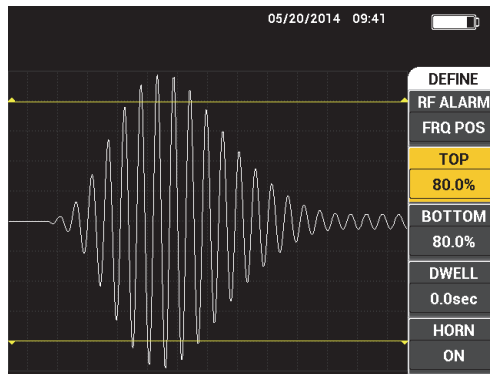

Figure 5-11 Alarm threshold control

BOTTOM

The **BOTTOM** setting controls the alarm's lower threshold. The displayed percentage is a percentage of the total screen height. An example of this control is shown in Figure 5-11 on page 102.

To change the **BOTTOM** alarm threshold setting, press the C key, and then rotate the knob to the desired alarm threshold value.

DWELL

The **DWELL** setting controls the amount of time that the alarm is active after the alarm condition has occurred. The alarm duration is adjustable between 0.0 seconds (off) and 10 seconds. An example of this control is shown in Figure 5-12 on page 103.

To change the **DWELL** setting, press the D key, and then rotate the knob to the desired alarm duration.

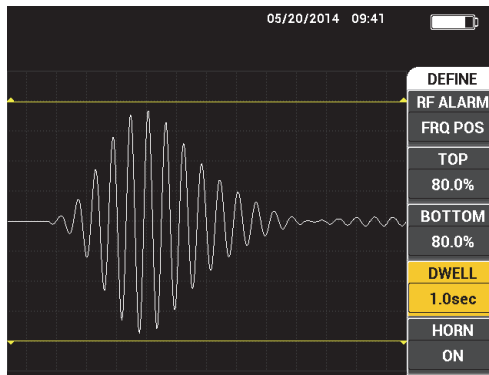

Figure 5-12 Alarm DWELL control

HORN

The **HORN** setting controls the alarm horn. The alarm horn has two options: **OFF** or **ON** (see Figure 5-13 on page 103).

To change the **HORN** setting, press the E key, and then rotate the knob to the desired setting.

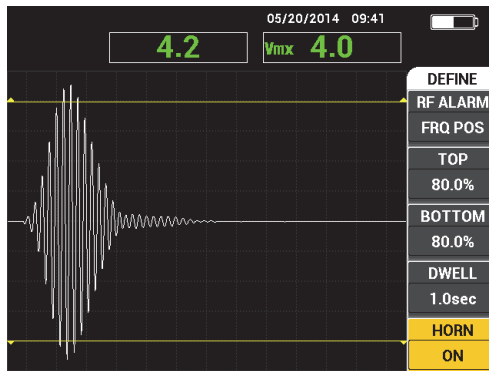

Figure 5-13 Alarm HORN control

5.3.10 PC RF Mode — ALARM Menu in RF+XY and XY RUN

The following parameters can be adjusted on the PC (RF) mode **ALARM** menu in RF+XY and XY RUN:

- **RF ALARM** (see “PC RF Mode — ALARM Menu in RF RUN” on page 101)
- **XY ALM 1** (see “PC Swept Mode — ALARM Menu” on page 104)
- **XY ALM 2** (see “PC Swept Mode — ALARM Menu” on page 104)
- **DWELL** (see “PC RF Mode — ALARM Menu in RF RUN” on page 101)
- **HORN** (see “PC RF Mode — ALARM Menu in RF RUN” on page 101)

5.3.11 PC RF Mode — ALARM Menu in XY-SCAN and XY RUN

The following parameters can be adjusted on the PC (RF) mode **ALARM** menu in XY SCAN and XY RUN:

- **SCAN ALM** (scan alarm) [see “MIA Mode — Alarm Menu” on page 111]
- **XY ALM 1** (see “PC Swept Mode — ALARM Menu” on page 104)
- **XY ALM 2** (see “PC Swept Mode — ALARM Menu” on page 104)
- **DWELL** (see “PC RF Mode — ALARM Menu in RF RUN” on page 101)
- **HORN** (see “PC RF Mode — ALARM Menu in RF RUN” on page 101)

5.3.12 PC Swept Mode — ALARM Menu

The following parameters can be adjusted on the PC Swept mode **ALARM** menu:

- **DEFINE** menu:
 - **SPEC ALM**
 - **XY ALM 1 (XY alarm 1)**
 - **XY ALM 2 (XY alarm 2)**
 - **DWELL**
 - **HORN**
- **XY ALM 1 (XY alarm 1)** menu:
 - **SHAPE**
- **XY ALM 2 (XY alarm 2)** menu:
 - **SHAPE**

NOTE

For **DWELL** and **HORN** parameter adjustment details, see “PC RF Mode – ALARM Menu in RF RUN” on page 101. Parameter descriptions are based on the presumption that the BondMaster 600 is set to PC Swept mode and the ALARM menu key () has been pressed.

SPEC ALM

The **SPEC ALM** (spectrum alarm) enables the alarm from the **SPECTRUM RUN**, and you can configure it as positive or negative.

To change the **SPEC ALM**, press the A key, and then rotate the knob to the desired setting.

XY ALM 1 (XY alarm 1)

The **XY ALM 1** (XY alarm 1) setting controls the XY 1 alarm type and can be set to **OFF**, **POS** (frequency positive), or **NEG** (frequency negative).

To change the XY alarm 1 type, press the B key, and then rotate the knob to the desired type.

XY ALM 2 (XY alarm 2)

The **XY ALM 2** (XY alarm 2) setting controls the XY 2 alarm type and can be set to **OFF**, **POS** (frequency positive), or **NEG** (frequency negative).

To change the XY alarm 2 type, press the C key, and then rotate the knob to the desired type.

PC Swept mode’s **DWELL** and **HORN** examples are shown in Figure 5-14 on page 106 and Figure 5-15 on page 106.

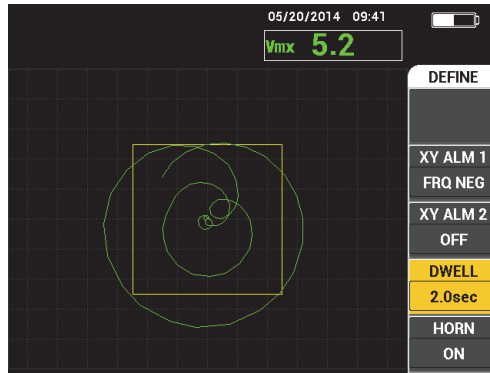

Figure 5-14 The PC Swept mode's alarm DWELL setting control

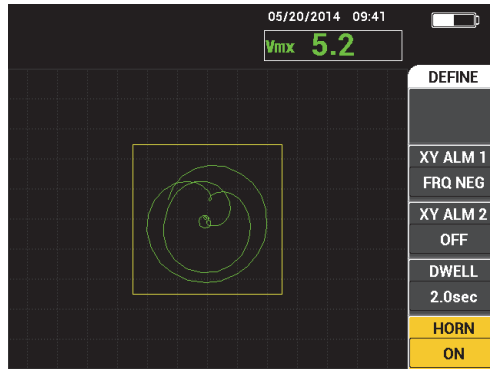



Figure 5-15 The PC Swept mode's alarm HORN setting control

SHAPE

NOTE

The **SHAPE** control is only available when the **XY ALM 1** (XY alarm1) or **XY ALM 2** (XY alarm 2) have been enabled. Therefore the following information is applicable only if these alarms have been enabled.

The **SHAPE** setting controls the shape of the alarm threshold. It can be set to **BOX**, **SECTOR**, or **CIRCLE**.

To change the shape of the **XY ALM 1** (XY alarm 1) threshold, press the **ALARM** menu key () twice, followed by the A key, and then rotate the knob to the desired alarm shape.

To change the shape of **XY ALM 2** (XY alarm 2) threshold, press the **ALARM** menu key () three times, followed by the A key, and then rotate the knob to the desired alarm shape.

NOTE

The chosen **SHAPE** can be adjusted using the function keys (B, C, D, and E). Table 3 on page 107 shows the function key choices for the different alarm shapes.

Table 3 PC Swept mode XY ALM 1 & XY ALM 2 – SHAPE adjustments

Shape	XY ALM 1 & XY ALM 2 SHAPE function key			
	B key	C key	D key	E key
BOX	TOP	BOTTOM	LEFT	RIGHT
SECTOR	OUTR DIA	INNR DIA	STRT ANG	END ANG
CIRCLE	RADIUS	HORZ	VERT	N/A

5.3.12.1 Changing BOX Alarm Parameters in PC Swept Mode

NOTE

The following information is applicable when the **XY ALM 1** (XY alarm 1) or **XY ALM 2** (XY alarm 2) menu is active and the **BOX** option is selected in the **SHAPE** menu (see Figure 5-16 on page 108).

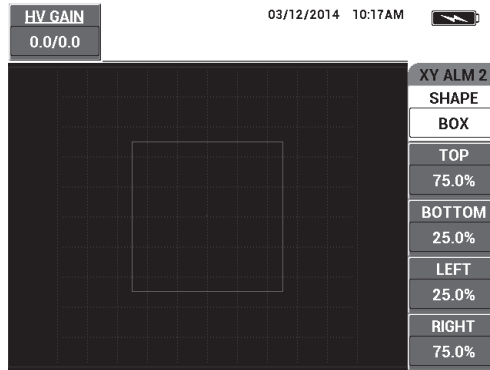

Figure 5-16 The PC Swept mode's BOX alarm shape controls

To change the shape of the BOX alarm (**XY ALM 1** [XY alarm 1] or **XY ALM 2** [XY alarm 2]), modify the following parameters:

- **TOP:** controls the top of the BOX alarm threshold. To change the setting, press the B key, and then rotate the knob until the threshold is in the desired position.
- **BOTTOM:** controls the bottom of the BOX alarm threshold. To change the setting, press the C key, and then rotate the knob until the threshold is in the desired position.
- **LEFT:** controls the left side of the BOX alarm threshold. To change the setting, press the D key, and then rotate the knob until the threshold is in the desired position.
- **RIGHT:** controls the right side of the BOX alarm threshold. To change the setting, press the E key, and then rotate the knob until the threshold is in the desired position.

5.3.12.2 Changing SECTOR Alarm Parameters in PC Swept Mode

NOTE

The following information is applicable when the **XY ALM 1** (XY alarm 1) or **XY ALM 2** (XY alarm 2) menu is active and the **SECTOR** option is selected in the **SHAPE** menu (see Figure 5-17 on page 109).

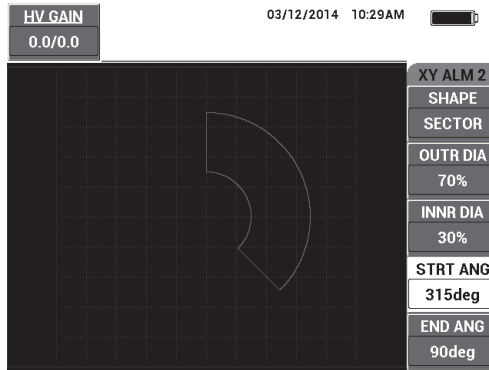

Figure 5-17 The PC Swept mode's SECTOR alarm shape controls

To change the shape of the SECTOR alarm (XY ALM 1 [XY Alarm 1] or XY ALM 2 [XY Alarm 2]), modify the following parameters:

- **OUTR DIA** (outer diameter): controls the outer diameter of the SECTOR alarm threshold. To change the setting, press the B key, and then rotate the knob until it is in the desired position.
- **INNR DIA** (inner diameter): controls the inner diameter of the SECTOR alarm threshold. To change the setting, press the C key, and then rotate the knob until it is in the desired position.
- **STRT ANG** (starting angle): controls the starting angle of the SECTOR alarm threshold. To change the setting, press the D key, and then rotate the knob until it is in the desired position.
- **END ANG** (ending angle): controls the ending angle of the SECTOR alarm threshold. To change the setting, press the E key, and then rotate the knob until it is in the desired position.

5.3.12.3 Changing CIRCLE Alarm Parameters in PC Swept Mode

NOTE

The following information is applicable when the **XY ALM 1** (XY alarm 1) or **XY ALM 2** (XY alarm 2) menu is active and the **CIRCLE** option is selected in the **SHAPE** menu (see Figure 5-18 on page 110).

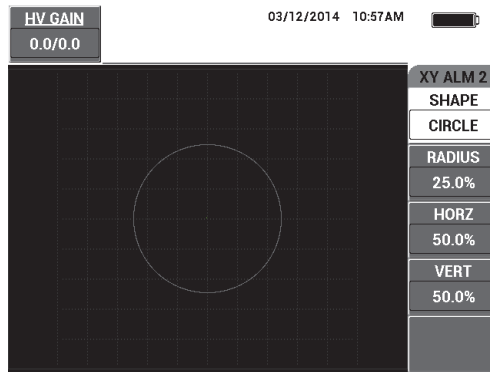

Figure 5-18 The PC Swept mode's CIRCLE alarm shape controls

To change the shape of the CIRCLE alarm (XY ALM 1 [XY Alarm 1] or XY ALM 2 [XY Alarm 2]), modify the following parameters:

- **RADIUS:** controls the diameter of the CIRCLE alarm threshold. To change the setting, press the B key, and then rotate the knob until the threshold is in the desired position.
- **HORZ** (horizontal): controls the horizontal position of the CIRCLE alarm threshold. To change the setting, press the C key, and then rotate the knob until the circle is in the desired position.
- **VERT** (vertical): controls the vertical position of the CIRCLE alarm threshold. To change the setting, press the D key, and then rotate the knob until the circle is in the desired position.

5.3.12.4 Changing Spectrum Alarm Parameters in PC Swept Mode

NOTE

The following information is applicable when the **SPEC ALM** (spectrum alarm) menu is active.

The following **SPEC ALM** options are available:

- **CHANNEL:** selects the channel where the alarm is set in the **SPECTRUM RUN** (either the **AMPLITUDE** or **PHASE** component).
-

- **TOP**: controls the top of the BOX alarm threshold. To change the setting, press the B key, and then rotate the knob until the threshold is in the desired position.
- **BOTTOM**: controls the bottom of the BOX alarm threshold. To change the setting, press the C key, and then rotate the knob until the threshold is in the desired position.
- **LEFT**: controls the left side of the BOX alarm threshold. To change the setting, press the D key, and then rotate the knob until the threshold is in the desired position.
- **RIGHT**: controls the right side of the BOX alarm threshold. To change the setting, press the E key, and then rotate the knob until the threshold is in the desired position.

5.3.13 MIA Mode — Alarm Menu

The following parameters can be adjusted in the MIA mode **ALARM** menu:

- **DEFINE** menu:
 - **SCAN ALM (scan alarm)**
 - **XY ALM 1 (XY alarm 1)**
 - **XY ALM 2 (XY alarm 2)**
 - **DWELL**
 - **HORN**
- **XY ALM 1 (XY alarm 1)** menu:
 - **SHAPE**
- **XY ALM 2 (XY alarm 2)** menu:
 - **SHAPE**

NOTE

For **XY ALM** and **SHAPE** parameter adjustment details, see “PC Swept Mode — ALARM Menu” on page 104. For **DWELL** and **HORN** details, see “PC RF Mode — ALARM Menu in RF RUN” on page 101. Parameter descriptions are based on the presumption that the BondMaster 600 is set to MIA mode and the ALARM menu key

() has been pressed.

SCAN ALM (scan alarm)

The **SCAN ALM** setting allows you to set up a threshold on the **SCAN RUN** displays.

To change the **SCAN ALM** setting, press the A key, and then rotate the knob to the desired setting.

The MIA mode's **DWELL** and **HORN** examples are shown in Figure 5-19 on page 112 and Figure 5-20 on page 112.

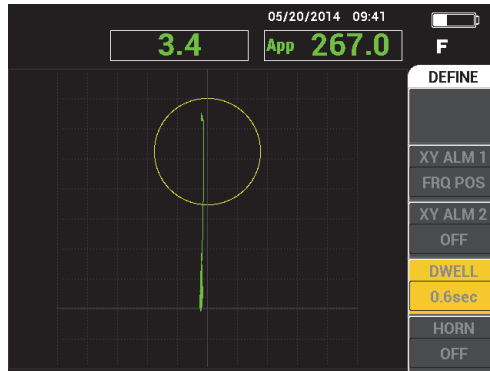

Figure 5-19 The MIA mode's alarm DWELL setting controls

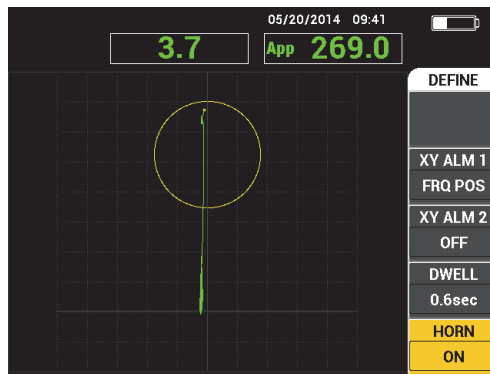

Figure 5-20 The MIA mode's alarm HORN setting control

5.3.14 RESON Mode — Alarm Menu

The following parameters can be adjusted in the RESON (resonance) mode **ALARM** menu:

- **DEFINE** menu:
 - **XY ALM 1 (XY alarm 1)**
 - **XY ALM 2 (XY alarm 2)**
 - **SCAN ALM (scan alarm)**
 - **DWELL**
 - **HORN**
- **XY ALM 1 (XY alarm 1)** menu:
 - **SHAPE**
- **XY ALM 2 (XY alarm 2)** menu:
 - **SHAPE**

NOTE

For **XY ALM** and **SHAPE** parameter adjustment details, see “PC Swept Mode — ALARM Menu” on page 104. For **SCAN ALM** details, see “MIA Mode — Alarm Menu” on page 111. For **DWELL** and **HORN** details, see “PC RF Mode — ALARM Menu in RF RUN” on page 101. Parameter descriptions are based on the presumption that the BondMaster 600 is set to RESON (resonance) mode and the ALARM menu

key () has been pressed.

The RESON mode’s **DWELL** and **HORN** examples are shown in Figure 5-21 on page 114 and Figure 5-22 on page 114.

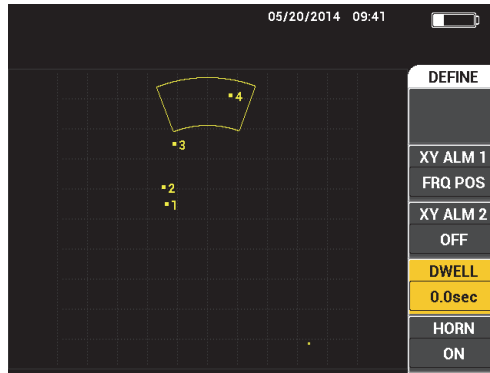

Figure 5-21 The RESON mode's alarm DWELL control

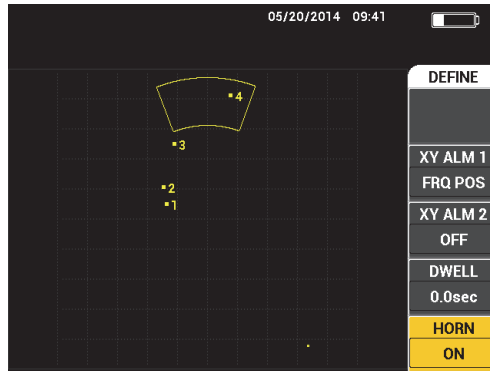

Figure 5-22 The RESON mode's alarm HORN control

5.3.15 MEM Menu

The **MEM** (memory) menu contains functions for storage of programs and screen (display) images. Various editing functions are provided in this menu for previewing saved data, recalling saved data, editing file names, adding notes, setting a reference image, and erasing saved data.

The BondMaster 600 is capable of storing and retrieving complete instrument setups. By default, the data is saved with the date, time, and an instrument-generated file name. If a PowerLink probe remains connected when the data is saved, the probe part number and description are also recorded.

After the data is stored, you can give the file a new name, which may contain up to 29 alphanumeric characters. Notes can also be added to the file.

Changes to the file name and notes are made using the front panel of the BondMaster 600, or alternatively, by using the BondMaster PC software (included with each instrument).

NOTE

Whenever a program (a stored data file) is recalled, the currently active instrument settings are overwritten and cannot be recovered, unless these settings were previously stored in another program location.

The following memory storage (**MEM**) functions are available:

PREVIEW

You can use **PREVIEW** to view instrument screen images that were captured at the moment the data was saved. To preview a stored data file, press the MEM menu key () , rotate the knob until the desired data file is highlighted, and then press the A key. The instrument screen image that was stored when the data file was saved will appear on the BondMaster 600 screen. The following actions can then be performed:

- Go back (return to the previous menu) by pressing the A key.
- Recall the stored data file by pressing the B key.
- Set the data file as a reference image by pressing the D key.

RECALL

This function resets the BondMaster 600 and loads the instrument settings associated with the recalled data file.

To recall a stored data file, press the MEM menu key () , rotate the knob until the desired data file is highlighted, and then press the B key. The BondMaster 600 recalls the data file with the instrument settings that were stored when the data file was saved.

EDIT



Using the **EDIT** function, you can edit the name of a file and add **FILE NOTES** (text) to the stored data.

To add or edit text (**FILE NAME** or **FILE NOTE**) of a stored data file, press the MEM menu key () , rotate the knob until the desired data file is highlighted, and then press the C key; a text editor will appear on the BondMaster 600 display.

For more information, see “Memory Text Editor” on page 117.

SET REF (set reference image)

While performing inspections, you can use the SET REF function to display a saved screen image on the BondMaster 600 display in a contrasting color. This reference image remains on the display until the **SET REF** function is turned off.

To display a reference image, press the MEM menu key () , rotate the knob until the desired data file is highlighted, and then press the D key. Alternatively, a reference image may be created using the current screen image by pressing and holding the REF SAVE direct function key () until the BondMaster 600 emits a sound alert.

To turn off a reference image, press the MEM menu key () , and then press the E key.

NOTE

An error message will appear when turning on the **SET REF** (set reference) function if the selected RUN (display mode) as recorded in the file is not compatible with the currently active RUN.

For example, an error message occurs if you try to activate a **SET REF** image that is configured to the RF + XY RUN mode when the current RUN mode is RF SIGNAL.

ERASE

Use this function to erase a program number (stored data file).

To erase a stored data file, press the MEM menu key () , rotate the knob until the desired data file is highlighted, and then press the E key.

STORE

Use **STORE** to overwrite an existing file with the current settings and data.

To overwrite a file, select it with the knob, press the MEM menu key () twice (until the **GENERAL** page is displayed), and then press the A key and follow the instructions that appear on the screen.

5.3.16 Memory Text Editor

The memory text editor appears on the BondMaster 600 screen when editing the file name or file text fields. This section of the manual provides instructions on how to use this editor to change file names and file notes.

NOTE

The following procedure is applicable when the MEM menu key () has already been pressed, and that the **FILE MANAGER** menu is displayed (see Figure 5-23 on page 118).

To use the memory text editor

1. Rotate the knob to highlight the file to be edited.
2. Press the FULL NEXT key () to navigate to the desired item to be edited: **FILE NAME** or **FILE NOTE**.
3. Press the C key.

The memory text editor is activated on the BondMaster 600 display (see Figure 5-23 on page 118).

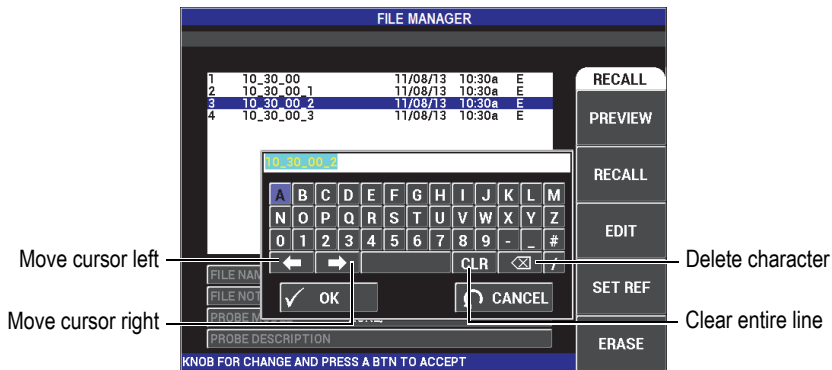





Figure 5-23 The FILE MANAGER menu's memory text editor and special buttons







4. Use the knob to select characters, and press the FULL NEXT key () to accept the characters.
5. After the **FILE NAME** or **FILE NOTE** has been edited, press  to save the changes, or press  to exit without saving.

NOTE









By default, the text editor will highlight the entire original default file name. If a key is subsequently pressed, the default file name or file note will be deleted. This is also the case for a previously edited **FILE NAME** or **FILE NOTE**. However, it is possible to avoid deletion (retain the information) by using the text editor navigations keys or buttons, as outlined in the procedure steps that follow.

The navigation keys or special buttons in the text editor allow you to modify characters that have been mistakenly selected, or modify previously entered information, without the need to retype the entire field (see Figure 5-23 on page 118, which identifies the special buttons and characters).



To insert a character using the navigation keys

1. Rotate the knob until the forward () or backward () arrow is highlighted.
2. Press the FULL NEXT key () until the cursor is in the correct location.
3. Use the knob to select characters, and press the FULL NEXT key () to accept characters.
4. After all the desired characters have been selected, press  to accept, or press  (return) to cancel.

To delete a character using the navigation keys

1. Rotate the knob until the forward () or backward () arrow is highlighted.
2. Press the FULL NEXT key () until the cursor is in the correct location (after the character to be deleted).
3. Use the special deletion button () to delete the character(s) by pressing the FULL NEXT key ().
4. If required, use the knob and the FULL NEXT key () to add new characters.
5. After completing the deletion(s) or addition(s), press  to accept, or press  (return) to cancel.

To clear (delete) the entire field using the navigation keys

- ◆ To delete the entire field (line) and reenter information at any time during text editing, rotate the knob and select the clear button () , and then press the FULL NEXT key () .



5.3.17 Advanced Setup Menu — ADV SETUP Menu Key

The advanced setup menu provides access to the following functions:

APPL SELECT (application select), **ALL SETTINGS**, **MODE** (inspection mode), **CAL** (only for MIA and Resonance modes), **COLOR**, **PASSWORD**, **SYSTEM SETUP**, **UNLOCK OPTIONS**, **ABOUT**, and **RESET**. For details about **SYSTEM SETUP**, see “Setting the User Interface Language and Decimal Symbol” on page 71.

APPL SELECT (application select)

Provides access to the application selection menu, which opens in a new window (see Figure 5-24 on page 120).

To select an application, press the ADV SETUP menu key (), followed by the A key. Rotate the knob to select the desired application, and then press  .

Or, to exit the menu, press the Return key ().

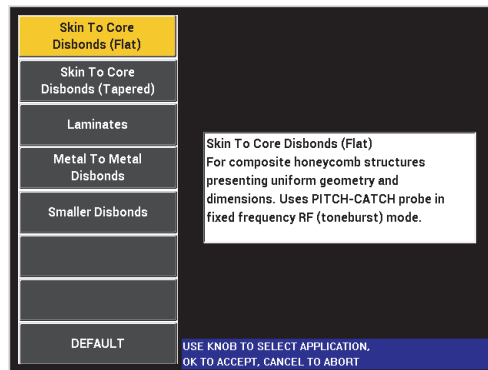

Figure 5-24 The APPL SELECT menu

The available applications allow you to quickly set up the BondMaster 600 for commonly used bond testing inspections.

NOTE

The BondMaster 600 applications are designed for quick setup of the instrument. However, always follow published maintenance procedures when inspecting.

ALL SETTINGS

The **ALL SETTINGS** menu gives you access to all BondMaster 600 functions. They are contained in two separate screens (menus) to keep the text easy to read and to navigate (see Figure 5-25 on page 121).

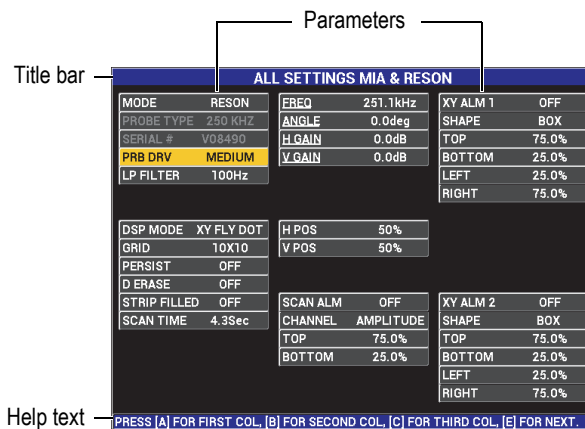



Figure 5-25 The ALL SETTINGS menu (first of two screens)

To select **ALL SETTINGS**, press the ADV SETUP menu key () followed by the B key. To navigate the menu or to go to the next screen, follow the instructions in the help text located at the bottom of the screen. To select a setting to adjust,

press the FULL NEXT key () until the desired setting is highlighted, and then rotate the knob until the desired value is shown.

NOTE

The BondMaster 600 does not require you to use the Enter key to save the selection made on any of its menus. Instead, the selected (and displayed) value is automatically saved.

CAL

Opens the calibration menu (only for MIA and Resonance modes).

COLOR

The BondMaster 600 includes user-selectable color schemes.

The color palette on the screen can be changed as follows:

- (1) Press the ADV SETUP menu key (.
- (2) Press the E key, and then rotate the knob to select the color palette.

PASSWORD

The stored data and the instrument reset capabilities can be protected with a password to prevent accidental deletion of data (see Figure 5-26 on page 122).

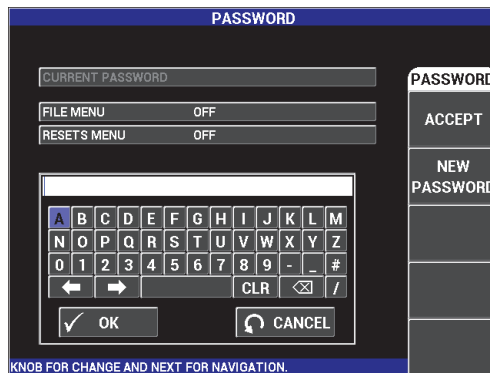





Figure 5-26 The PASSWORD menu

The **PASSWORD** function is accessed as follows:

1. Press the ADV SETUP menu key ( twice.

2. Press the A key.

The password is set as follows:

1. Press the FULL NEXT key () to navigate to the item that you want to protect with a password: **FILE MENU** or **RESETS MENU**.
2. Press the FULL NEXT key () to navigate to the text editor.
3. Rotate the knob to select the characters of the password. When finished, press the A key to **ACCEPT**.
4. Press the FULL NEXT key () to navigate to another item to protect with a password, and repeat steps 1 through 3 above, or press  to exit.

UNLOCK OPTIONS

This function provides access to purchased instrument upgrades that you are able to activate using an option code (provided with your purchase). These include model upgrades such as B600 to B600M. For a full list of possible upgrades and part numbers, see “Accessories, Replacement Parts, and Upgrades” on page 229.

To unlock options, press the ADV SETUP menu key () twice, followed by the C key, and then enter the option code for the upgrade.

For more information on this feature, contact your local Evident representative. Contact information for your region can be found by visiting the Evident website at <https://www.olympus-ims.com/en/contact-us/>.

ABOUT

This feature displays the instrument’s configuration and other important information. Occasionally, when required by service technicians or product representatives, this feature helps factory personnel identify your BondMaster 600 and/or troubleshoot problems. It is provided to help meet current user requirements and also assists with any future upgrades.

To access the **ABOUT** menu, press the ADV SETUP menu key () twice, followed by the D key.

The **ABOUT** menu provides access to the following sections:

BATT & TEMP (battery and instrument temperature, battery level, battery capacity, battery design capacity, and battery status), **LEGAL INFO** (legal information), **UPGRADE** (instrument software upgrade), and **TESTS** (see Figure 5-27 on page 124).

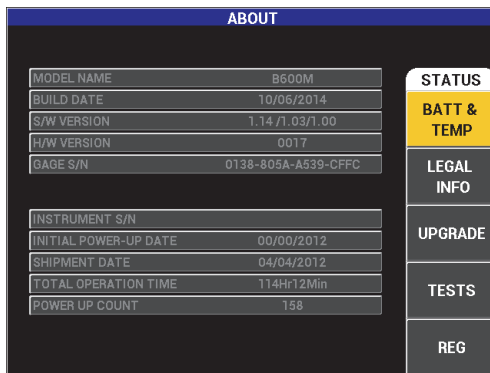



Figure 5-27 The ABOUT menu



BATT & TEMP

Provides the battery and instrument internal temperature, and information on model name, date of manufacture, software and hardware versions, instrument serial number, etc.



To access the **BATT & TEMP** menu, press the ADV SETUP menu key () twice, followed by the D key, and then the A key. To exit, press the Return key ().

LEGAL INFO

Displays legal or patent rights protection information for the BondMaster 600.

To access the **LEGAL INFO** menu, press the ADV SETUP menu key () twice, followed by the D key and then the B key. To navigate the menu, follow the instructions in the help text at the bottom of the screen. To exit, press the Return key (.

REG

Displays regulatory information for the BondMaster 600 (see Figure 5-28 on page 125). To access the **REG** (Regulatory) menu, press the ADV SETUP menu key () twice, followed by the D key and then the E key. To exit, press the Return key (.

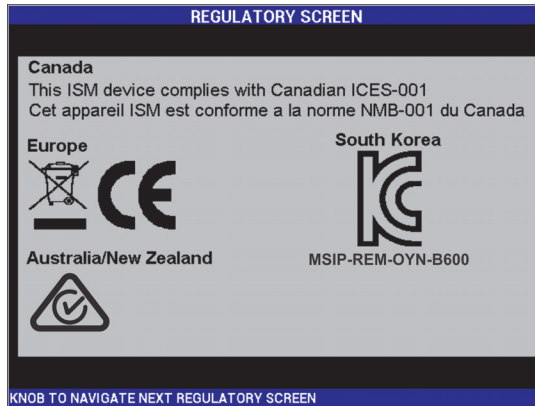



Figure 5-28 The REGULATORY SCREEN

UPGRADE

Provides access to the communication link between your BondMaster 600 and a PC on which the BondMaster PC software is installed.



NOTE

BondMaster PC software is required to update the BondMaster 600 operating software.

To access the **UPGRADE** menu, press the ADV SETUP menu key () twice, followed by the D key and the C key, and then follow the instructions on the screen. To exit, press the Return key (.

TESTS

Provides user-accessible tests to help troubleshoot the BondMaster 600. Tests include **VIDEO TEST**, **KEYPAD TEST**, **SD CARD TEST**, and **LED TEST**.

To access the **TESTS** menu, press the ADV SETUP menu key () followed by the D key. Rotate the knob until the desired test is shown and then press the A key to begin the test. To exit the **TESTS** menu, press the Return key (.

- **VIDEO TEST**—Checks the BondMaster 600 by displaying three equal-width color bands: red, green, and blue. The test fails if one or more of the equal-width bands is not present. To exit the video test, press the Return key (↵). Subsequently, the **TESTS** menu reappears on the BondMaster 600 display.
- **KEYPAD TEST**—Checks if the BondMaster 600 keypad is operating correctly and displays the last key that was pressed. The test continues until the Return key (↵) is pressed. Subsequently, the **TESTS** menu reappears on the BondMaster 600 display.
- **SD CARD TEST**—Checks the internal SD card and external SD card (if present), and presents a **PASSED** or **FAILED** response. To exit the SD card test, press the Return key (↵). Subsequently, the **TESTS** menu reappears on the BondMaster 600 display.

NOTE

If an external SD card is not present during the SD card test, **FAILED** is displayed for this storage device.

- **LED TEST**—Checks if the BondMaster 600 LEDs (light-emitting diodes) are operational. The LEDs are located at the top-left corner of the BondMaster 600, and are marked with the numbers 1, 2, and 3. During the test, each of the LEDs consecutively illuminate in a sequence of green, yellow/orange, and red. If any of these colors are not present, that LED is not working correctly. To exit the LED test, press the Return key (↵). Subsequently, the **TESTS** menu reappears on the BondMaster 600 display.

NOTE

The battery or charging indicator LED is not tested during the **LED TEST** and can instead be manually inspected. For more information on this LED, see “Charger/Adaptor” on page 37.

RESET

Provides the ability to reset the BondMaster 600 as follows:

1. To access the **RESET** menu, press the ADV SETUP menu key (ⓘ⚙️) twice followed by the E key, and then rotate the knob to select the desired type of instrument reset: parameters, storage, or master (see Figure 5-29 on page 127 and Table 4 on page 127).
2. To perform the reset, press the A key.
3. To exit, press the Return key (↩️).



Figure 5-29 The RESET menu

Table 4 Reset types

Reset types	Description
Parameters reset	Clears only the instrument settings, and returns the BondMaster 600 to its default settings.
Storage reset	Clears all stored programs and screen images.
Master reset	Clears the BondMaster 600 settings, stored programs, and screen images, and returns the BondMaster 600 to its default settings.

6. Applications

This section was prepared to help you obtain the best results, in the most efficient way possible, for the most common BondMaster 600 applications. While other procedures may lead to equivalent results, the steps and recommendations below reflect what Evident has determined to be the optimal way to use the BondMaster 600 instrument's numerous features. In consequence, the number of steps and operations are reduced to a minimum. Each of the following procedures can also be used as a good starting point for drafting your own procedures based on the BondMaster 600.

IMPORTANT

Disclaimer: This section is not to be used in place of authorized written procedures. The procedures in this section are intended as guidelines for optimizing the BondMaster 600 features, facilitating the configuration of commonly used bond testing applications, and self-training. **ALWAYS** closely follow an OEM procedure.

NOTE

Many Evident bond testing probes feature PowerLink technology. To fully benefit from the numerous BondMaster 600 features, it is recommended to load an application from the **APPLICATION SELECTION** menu after a PowerLink probe or accessory has been accepted.

6.1 Common BondMaster 600 Applications

This section contains example procedures that are commonly used for aircraft component inspections.

6.1.1 Detecting Skin-to-Core Disbonds in Honeycomb Composite — Flat or Constant Geometry Using PC RF or IMPULSE Techniques

Because the pitch-catch (PC) **RF** or **IMPULSE** mode uses a fixed frequency tone burst, it is well suited to inspect honeycomb composite parts that have constant geometry or that are flat. The choice of the frequency (normally selected and recommended by the part's manufacturer) will make a huge difference in the detection observed, and should be respected.

The procedure in this section is intended as a general guideline on how to prepare a setup for a honeycomb composite part; a similar procedure can easily be applied to a variety of skin and core materials.

Although PC **RF** or **IMPULSE** mode is a preferred technique for detecting skin-to-core disbonds in honeycomb composite, a similar procedure can sometimes be used to inspect metal-to-metal bonds or significant delamination in composite materials.

The following procedure is also intended to demonstrate the various important or new features of the BondMaster 600 and as such, shows alternate displays at the end. This purpose of this procedure is to detect and differentiate between near-side disbonds and far-side disbonds.

Inspection materials are shown in Figure 6-1 on page 131.

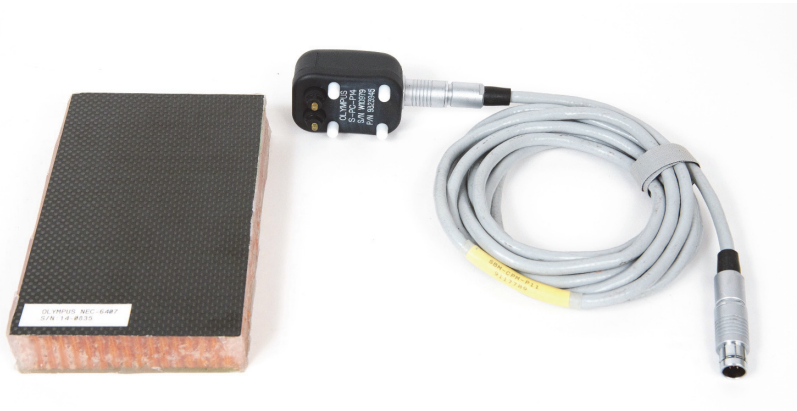

Figure 6-1 Materials – skin-to-core disbonds in flat or constant geometry

The following products are used in this procedure:

- Honeycomb composite training standard: 25 mm (1 in.) thick, 6-ply CFRP top skin and 3-ply fiberglass lower skin. Includes a 25 mm (1 in.) disbond on each side. P/N: NEC-6407 [U8862302]
- Cable for pitch-catch and MIA modes, 1.83 m (6 ft). P/N: SBM-CPM-P11 [U8800058]
- Pitch-catch probe for general use; tip spacing 14 mm. P/N: S-PC-P14 [U8800601]

To set the initial BondMaster 600 configuration

1. Connect the probe and the cable to the PROBE connector of the BondMaster 600.
2. When prompted, press **CONTINUE** (A key) to accept the PowerLink probe information.

NOTE

If you are using a non-PowerLink probe, access the **APPL SELECT** menu (A key) using the ADV SETUP menu key ().

3. Select the **Skin to Core Disbonds (Flat)** application, and then press  to accept (see Figure 6-2 on page 132).

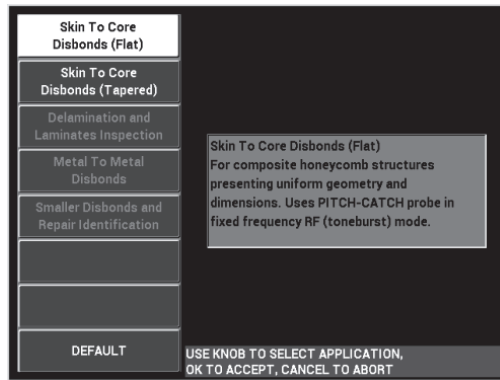



Figure 6-2 The Skin To Core Disbonds (Flat) application

To calibrate the signals

1. Press the MAIN menu key () once, and set the **FREQ** (A key) to **11 kHz** using the knob.
2. Set the probe tips over a good area of the standard, adjust the gain using the **GAIN** key (**dB**), and then ensure that the signal in the RF view (left) is contained between 1 to 2 vertical divisions (see Figure 6-3 on page 132).

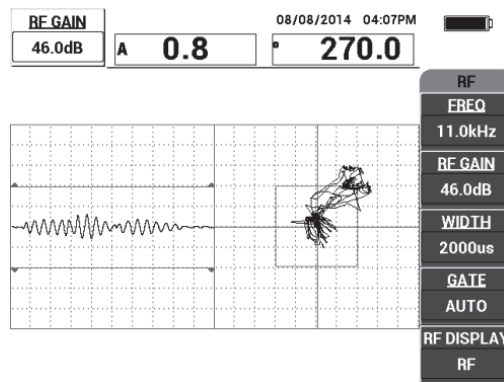

Figure 6-3 The GAIN adjustment to obtain a contained signal

3. Set the probe tips over a good area of the standard, and then press the CAL NULL key (CAL \odot).
4. Scan over the far-side and near-side disbonds, and then, while you keep the probe moving over the disbonds, ensure that both defects are detected (see Figure 6-4 on page 133).

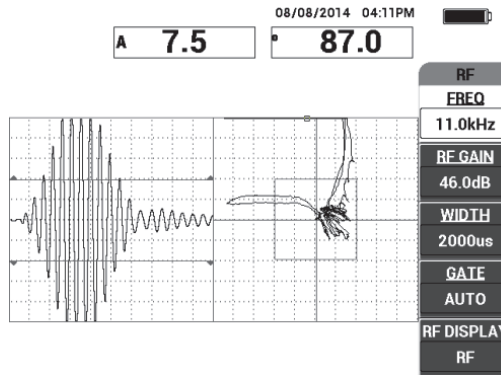

Figure 6-4 Detecting the far-side and near-side disbonds

GATE setup

NOTE

By default, the **GATE** is set to **AUTO**. In **AUTO** mode the BondMaster 600 automatically detects the peak signal from the RF view and uses it to construct the XY flying dot view.

5. If desired, manually set the gate to the desired position by pressing **GATE** (D key) and rotating the knob.
A recommended **GATE** position would be the peak of the first reflection.
The recommended **GATE** position is often to the left of the first strongest signal peak (see Figure 6-5 on page 134).

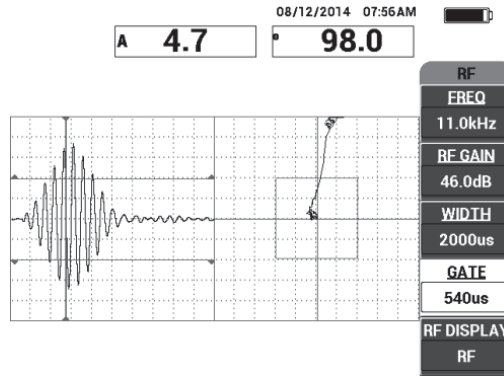

Figure 6-5 The recommended GATE position

IMPULSE display

NOTE

IMPULSE mode applies an envelope filter over the RF signal. (The name “**IMPULSE**” originates from earlier BondMaster products.)

6. If preferred, set the **RF DISPLAY** (E key) to **IMPULSE** (see Figure 6-6 on page 135). However, it is recommended to use the **RF DISPLAY** mode because it allows easier interpretation of each signal oscillation.

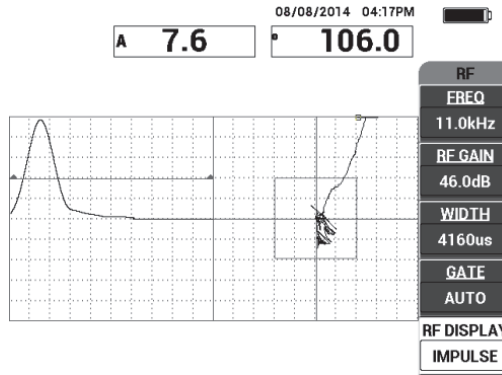

Figure 6-6 The IMPULSE display

TIP

When in **IMPULSE** mode, you can increase the **WIDTH** (C key) to spread the signal peak over fewer divisions.

To optimize the identification of near-side and far-side disbonds

1. Press the RUN key (▶) once to display the XY flying dot single view.
2. Set the probe's tips over a good area of the standard, and then press the CAL NULL key (CAL Ⓢ).
3. Scan over the far-side and near-side disbonds, and then, while you keep the probe moving over the disbonds, press the FREEZE key (❄) [see Figure 6-7 on page 136].

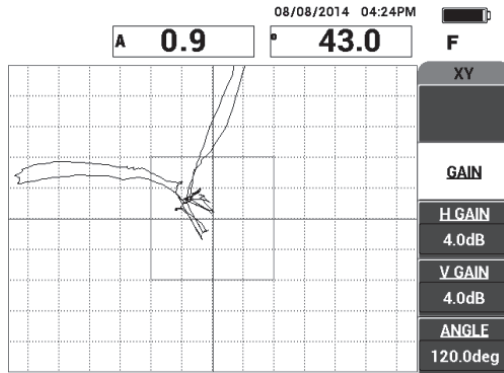

Figure 6-7 The scan over the disbonds

4. While on the **MAIN** menu, press **ANGLE** (E key), and then adjust the signal angle so the far-side disbond goes down and the near-side disbond goes up (see Figure 6-8 on page 136).

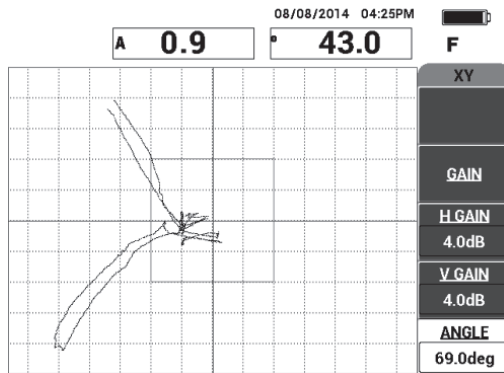

Figure 6-8 Adjusting the disbond signal angle

5. If necessary, adjust the **H GAIN** (C key) and **V GAIN** (D key) to obtain a clearer distinction between the near- and far-side disbonds (see Figure 6-9 on page 137).

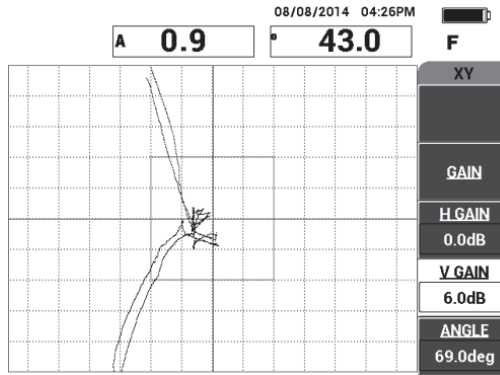

Figure 6-9 Adjusting the H GAIN and V GAIN

6. Press the FREEZE key (❄) again to restart the acquisition.
7. Press the FULL NEXT key (➡) to toggle to full-screen mode.

The readings display in real time the amplitude (A) and phase ($^{\circ}$) of the XY flying dot (see Figure 6-10 on page 137). For information on how to change the real-time readings, see “Displaying Real-Time Readings” on page 66.

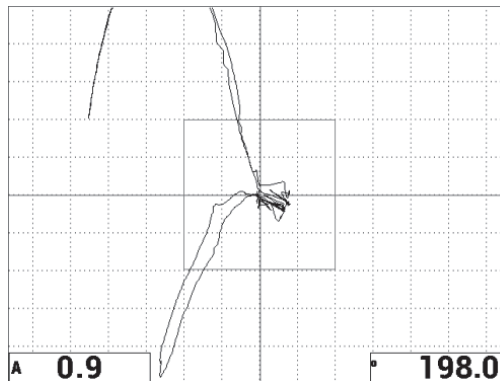



Figure 6-10 The amplitude (A) and phase ($^{\circ}$) of the XY flying dot

The new SCAN display and alternate RUNs

- To instantly switch between various signal representations during inspection (in full or normal screen mode), press the RUN key () repeatedly to obtain the desired RUN.

The available RUNs are shown in Figure 6-11 on page 138 through Figure 6-15 on page 140.

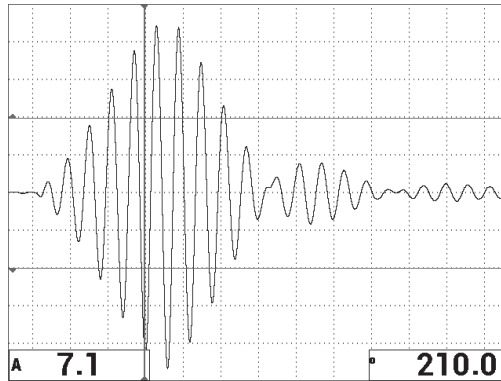

Figure 6-11 RUN 1 — RF signal

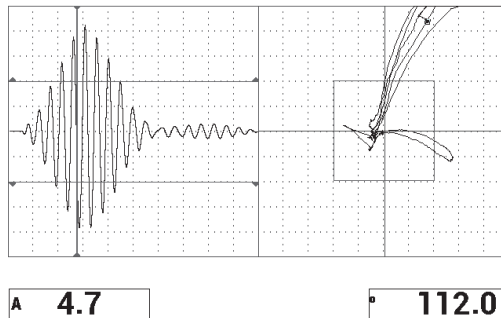

Figure 6-12 RUN 2 — RF + XY (default view)

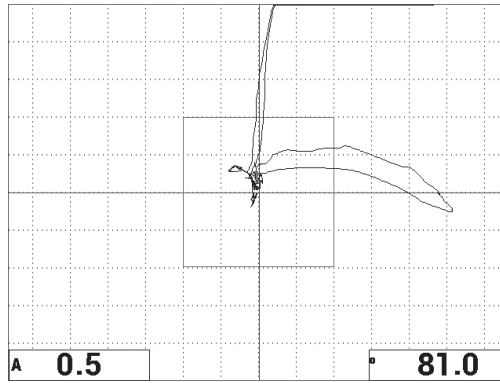

Figure 6-13 RUN 3 – XY FLY DOT

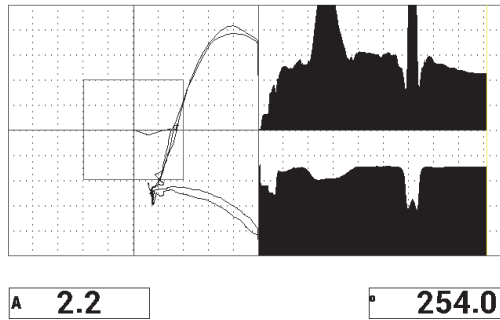

Figure 6-14 RUN 4 – XY + SCAN

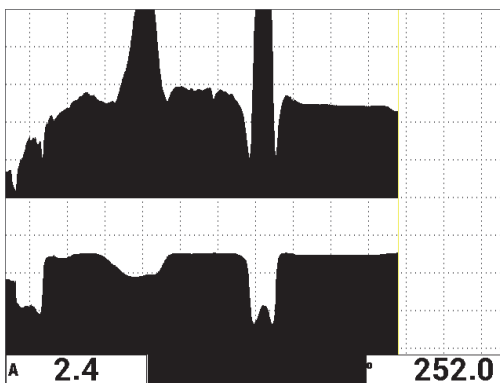

Figure 6-15 RUN 5 – SCAN

TIP

To obtain clearer phase readings in the SCAN views, it is recommended to NULL the probe in the air.

To fine-tune the instrument settings

1. Depending on your requirements, set the alarm box parameters, horn, or external horn (louder). For more details about alarms, see “Alarms, Connectivity, and Memory Specifications” on page 225.
2. Depending on your requirements, change your real-time readings.
The default real-time readings display the XY signal’s live amplitude and phase. For information on how to change the real-time readings, see “Displaying Real-Time Readings” on page 66.
The list of all parameters is shown in Figure 6-16 on page 141.

ALL SETTINGS PC (RF)			
MODE	PC (RF)	FREQ	11.0kHz
PROBE TYPE	Broadband	ANGLE	120.0deg
SERIAL #	T06665	H GAIN	4.0dB
PRB DRV	MEDIUM	V GAIN	4.0dB
LP FILTER	10Hz	RF GAIN	46.0dB
REP RATE	300		
		XY ALM 1	NEG
		SHAPE	BOX
		TOP	70.0%
		BOTTOM	30.0%
		LEFT	30.0%
		RIGHT	70.0%
DSP MODE	RF + XY	H POS	50%
RF DISPLAY	RF	V POS	50%
GRID	FINE		
PERSIST	OFF	XY ALM 2	OFF
D ERASE	OFF	SHAPE	CIRCLE
SCAN TIME	5.0Sec	RADIUS	20.0%
FILLED SCAN	ON	HORZ	50.0%
		VERT	50.0%
GATE	AUTO	RF ALARM	POS
WIDTH	2000us	TOP	70.0%
NUM CYCLES	10	BOTTOM	30.0%
		BOTTOM	25.0%
PRESS [A] FOR FIRST COL, [B] FOR SECOND COL, [C] FOR THIRD COL, [E] FOR NEXT.			

ALL SETTINGS PC (RF)	
HORN	OFF
DWELL	0.0sec
EXT HORN	ON
CAP MODE	INSTANT
CAP DLY	10.0sec
RDG1 TYP	A
RDG1 LOC	BOT LEFT
RDG2 TYP	Phase
RDG2 LOC	BOT RIGHT
AOUT PWR	OFF
PRESS [A] FOR FIRST COL, [B] FOR SECOND COL, [E] FOR PREV.	

Figure 6-16 The list of all parameters

6.1.2 Detecting Skin-to-Core Disbonds in Honeycomb Composite — Tapered or Varying Geometry Using PC Swept Technique

The pitch-catch (PC) swept technique is ideal for inspecting honeycomb composite parts with tapered or varying geometry. This technique works well on a variety of skin and cores, but it works especially well with aluminum honeycomb cores.

The PC Swept technique typically works better for near-side disbonds than far-side disbonds. It can also be used to inspect flatter or constant geometry parts, although the RF and IMPULSE techniques are typically preferred for such parts, particularly for thicker assemblies.

This procedure describes how to set up for a typical PC Swept inspection, using an aluminum core standard. The choice of the frequency range (normally selected and recommended by the part's manufacturer) should be respected.

Inspection materials are shown in Figure 6-17 on page 142.



Figure 6-17 Materials — skin-to-core disbonds in tapered geometry

The following products are used in this procedure:

- Honeycomb composite training standard: 25 mm (1 in.) thick, 1 mm top and bottom aluminum skin and aluminum core. Includes a 25 mm (1 in.) disbond on each side. P/N: NEC-6312 [U8860498]
- Cable for pitch-catch and MIA modes, 1.83 m (6 ft). P/N: SBM-CPM-P11 [U8800058]
- Pitch-catch probe for general use; tip spacing 14 mm. P/N: S-PC-P14 [U8800601]

To set the initial BondMaster 600 configuration

1. Connect the probe and the cable to the PROBE connector of the BondMaster 600.
2. When prompted, press **CONTINUE** (A key) to accept the PowerLink probe information.

NOTE

If you are using a non-PowerLink probe, access the **APPL SELECT** menu (A key) using the ADV SETUP menu key ().

3. Select the **Skin To Core Disbonds (Tapered)** application, and then press  to accept (see Figure 6-18 on page 143).

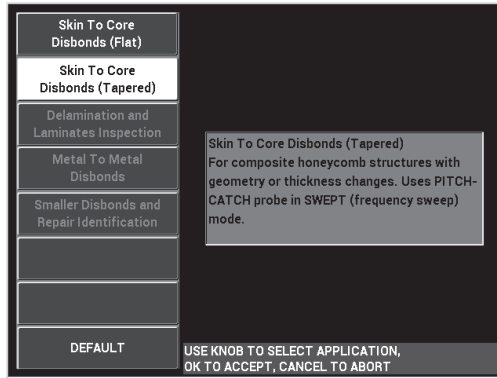



Figure 6-18 The Skin To Core Disbonds (Tapered) application

To calibrate the signals

1. Press the MAIN menu key () once, and then use the knob to set the **START FREQ** (C key) to **10 kHz** and the **STOP FREQ** (D key) to **40 kHz**.
2. Place the probe tips on a good part of the standard, press the **GAIN** key (**dB**) and then use the knob to adjust the gain until the swept figure is contained between two divisions inside the alarm box (see Figure 6-19 on page 143).

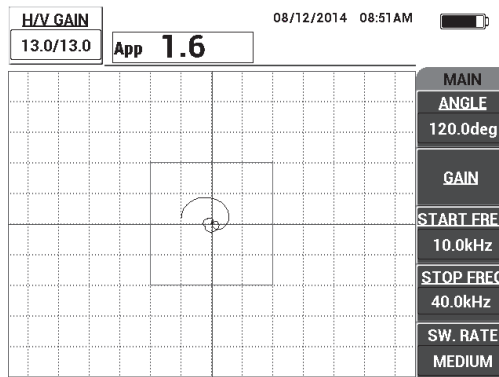



Figure 6-19 The swept figure between two divisions

3. While the probe is still on a good part of the standard, press the CAL NULL key .
4. Scan over the defects and ensure that the signal goes outside the alarm box. Readjust the **GAIN** as needed.
5. Press the FULL NEXT key  to display the full screen, and then scan over defects again (see Figure 6-20 on page 144).

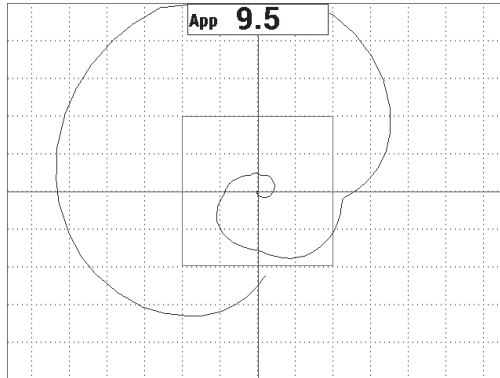

Figure 6-20 The full-screen display of the scan

To fine-tune the instrument settings

1. Depending on your requirements, set the alarm box parameters, horn, or external horn (louder). For more details about alarms, see “Alarms, Connectivity, and Memory Specifications” on page 225.
2. Depending on your requirements, change your real-time readings.
The default real-time readings display the XY signal’s live peak-to-peak amplitude. For information on how to turn off the real-time readings, see “Displaying Real-Time Readings” on page 66.
The list of all parameters is shown in Figure 6-21 on page 145.

ALL SETTINGS PC SWEPT					
MODE	PC SWEPT	START_FREQ	10.0kHz	XY ALM 1	NEG
PROBE TYPE	Broadband	STOP_FREQ	40.0kHz	SHAPE	BOX
SERIAL.#	T06665	ANGLE	120.0deg	TOP	70.0%
PRB DRV	MEDIUM	H_GAIN	13.0dB	BOTTOM	30.0%
LP FILTER	30Hz	V_GAIN	13.0dB	LEFT	30.0%
SWEPT RATE	MEDIUM			RIGHT	70.0%
		FRQ1_TRACK	OFF		
		FRQ2_TRACK	OFF		
		RECORD	ON		
DSP MODE	XY FLY DOT	SPEC. ALM	OFF	XY ALM 2	OFF
GRID	FINE	CHANNEL	AMPLITUDE	SHAPE	CIRCLE
D ERASE	OFF	TOP	75.0%	RADIUS	20.0%
		BOTTOM	25.0%	HORZ	50.0%
		LEFT	25.0%	VERT	50.0%
		RIGHT	75.0%		

ALL SETTINGS PC SWEPT			
HORN	OFF	RDG1 TYP	Ampl pk-pk
DWELL	0.0sec	RDG1 LOC	TOP CNTR
EXT HORN	ON		
CAP MODE	INSTANT		
CAP DLY	10.0sec	AOUT PWR	OFF

PRESS [A] FOR FIRST COL., [B] FOR SECOND COL., [C] FOR THIRD COL., [E] FOR NEXT. PRESS [A] FOR FIRST COL., [B] FOR SECOND COL., [E] FOR PREV.

Figure 6-21 The list of all parameters

6.1.3 Detecting Smaller Disbonds in Honeycomb Composite — Mechanical Impedance Analysis (MIA) Technique

The smaller tips of the MIA probes, combined with the expanded frequency range of the BondMaster 600, are ideal for detecting smaller defects in honeycomb composites. This procedure demonstrates how to use the MIA test mode to detect defects in honeycomb composite assemblies using a suggested test frequency. A more advanced procedure for determining the best test frequency for your particular situation is explained in “Finding the Best Frequency to Inspect Honeycomb Composite — Mechanical Impedance Analysis (MIA) Technique” on page 174.

Inspection materials are shown in Figure 6-22 on page 146.



Figure 6-22 Materials — smaller disbonds using MIA technique

The following products are used in this procedure:

- Honeycomb composite training standard: 25 mm (1 in.) thick, 3 and 6 ply CFRP top skin, and 3 ply fiberglass bottom skin. Includes one 13 mm (0.5 in.) and one 25 mm (1 in.) disbond on each side. P/N: NEC-6433 [U8620490].
- Cable for pitch-catch and MIA modes, 1.83 m (6 ft). P/N: SBM-CPM-P11 [U8800058]
- Right angle MIA probe, 13 mm (0.5 in.) tip. P/N: S-MP-3 [U8010011]

To set the initial BondMaster 600 configuration

1. Connect the probe and the cable to the PROBE connector of the BondMaster 600.
2. When prompted, press **CONTINUE** (A key) to accept the PowerLink probe information.

NOTE

If you are using a non-PowerLink probe, access the **APPL SELECT** menu (A key) using the ADV SETUP menu key ().

3. Select the **Smaller Disbonds and Repair Identification** application, and then press  to accept (see Figure 6-23 on page 147).

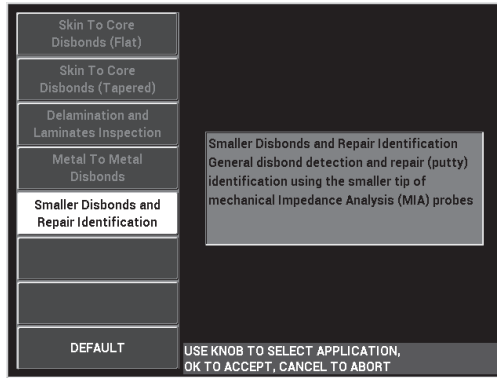





Figure 6-23 The Smaller Disbonds and Repair Identification application

To calibrate the signals

1. Press the MAIN menu key () once, and then set the **FREQ** (A key) to **10 kHz** using the knob.
2. Place the probe tip on a good part of the standard (CFRP side), and then press the CAL NULL key ().
3. Slowly scan over one of the 13 mm (0.5 in.) disbonds, and then press the FREEZE key () [see Figure 6-24 on page 147].

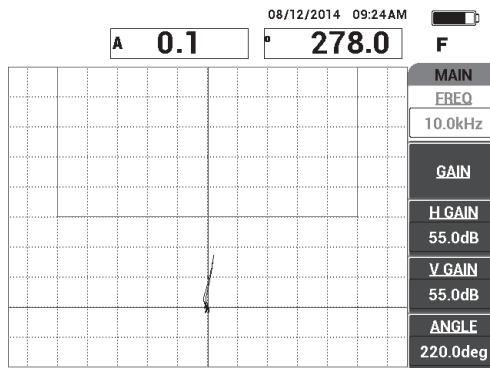

Figure 6-24 The scan signal of a disbond

- Press **ANGLE** (E key), and then adjust the signal angle so that the signal points upwards towards the alarm box (see Figure 6-25 on page 148).

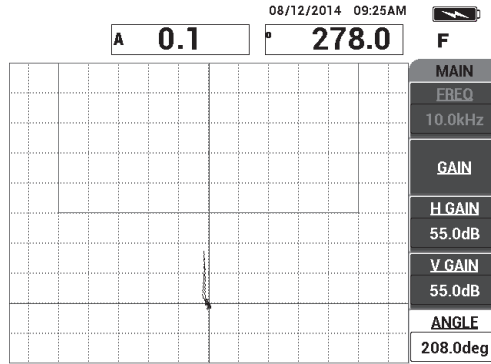

Figure 6-25 The signal angle adjusted upwards

- Press the **GAIN** key (**dB**), and then adjust the signal amplitude so that the disbond signal enters the alarm box and extends approximately 5 divisions from the null position (cross hairs) [see Figure 6-26 on page 148].

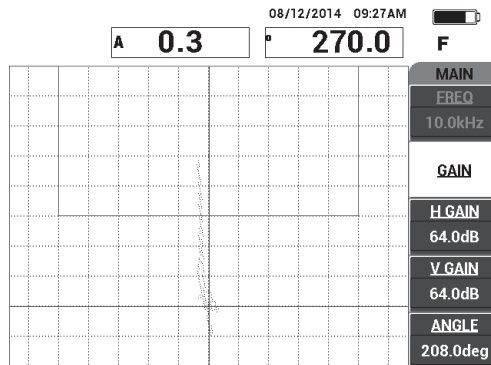

Figure 6-26 The signal amplitude adjusted to enter the alarm box

6. Press the FREEZE key (❄) to unfreeze the acquisition, and then press the FULL NEXT key (➡) to display the full screen.
7. Scan over the 13 mm (0.5 in.) disbond again (see Figure 6-27 on page 149).

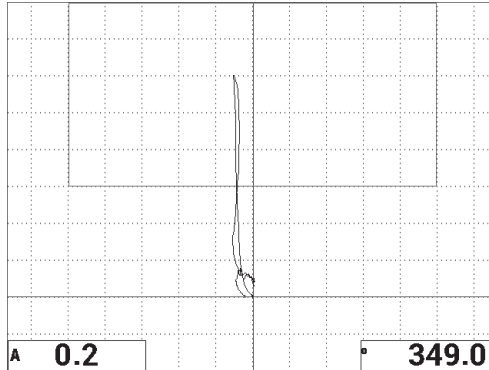

Figure 6-27 The second scan over the disbond

To fine-tune the instrument settings

1. Depending on your requirements, set the alarm box parameters, horn, or external horn (louder). For more details about alarms, see “Alarms, Connectivity, and Memory Specifications” on page 225.
2. Depending on your requirements, change your real-time readings.
The default real-time readings display the XY signal’s live amplitude and phase. For information on how to change the real-time readings, see “Displaying Real-Time Readings” on page 66.
The list of all parameters is shown in Figure 6-28 on page 150.

ALL SETTINGS MIA & RESON					
MODE	MIA	FREQ	10.0kHz	XY ALM 1	POS
PROBE TYPE	MIA	ANGLE	208.0deg	SHAPE	BOX
SERIAL #	N13302	H.GAIN	64.0dB	TOP	100.0%
PRB DRV	MEDIUM	V.GAIN	64.0dB	BOTTOM	50.0%
LP FILTER	30Hz			LEFT	0.0%
				RIGHT	100.0%
DSP MODE	XY FLY DOT	H POS	50%		
GRID	FINE	V POS	20%		
PERSIST	OFF				
D ERASE	OFF				
FILLED SCAN	ON	SCAN ALM	OFF	XY ALM 2	OFF
SCAN TIME	5.0Sec	CHANNEL	AMPLITUDE	SHAPE	CIRCLE
DOT MODE	XY	TOP	75.0%	RADIUS	20.0%
		BOTTOM	25.0%	HORZ	50.0%
				VERT	50.0%

ALL SETTINGS MIA & RESON	
HORN	OFF
DWELL	0.0sec
EXT HORN	OFF
CAP MODE	INSTANT
CAP DLY	10.0sec
RDG1 TYP	A
RDG1 LOC	BOT LEFT
RDG2 TYP	Phase
RDG2 LOC	BOT RIGHT
ADOUT PWR	OFF

PRESS [A] FOR FIRST COL. [B] FOR SECOND COL. [C] FOR THIRD COL. [E] FOR NEXT.

PRESS [A] FOR FIRST COL. [B] FOR SECOND COL. [E] FOR PREV.

Figure 6-28 The list of all parameters

6.1.4 Detecting Repaired Areas (Potting) in Honeycomb Composite — Mechanical Impedance Analysis (MIA) Technique

As MIA technology measures the mechanical impedance (or stiffness) of materials, it displays a high contrast between a repaired/potted area (which is stiff) and a disbond (which has low mechanical resistance). This contrast characteristic allows you to use the MIA test technique to identify repaired areas in honeycomb composite.

Inspection materials are shown in Figure 6-29 on page 150.



Figure 6-29 Materials — repaired areas (potting) using MIA technique

The following products are used in this procedure:

- Honeycomb composite training standard: 25 mm (1 in.) thick, 3 and 6 ply CFRP top skin, and 3 ply fiberglass bottom skin. Includes one 13 mm (0.5 in.) and one 25 mm (1 in.) disbond on each side. P/N: NEC-6433 [U8620490].
- Cable for pitch-catch and MIA modes, 1.83 m (6 ft). P/N: SBM-CPM-P11 [U8800058]
- Right angle MIA probe, 13 mm (0.5 in.) tip. P/N: S-MP-3 [U8010011]

To set the initial BondMaster 600 configuration

1. Connect the probe and the cable to the PROBE connector of the BondMaster 600.
2. When prompted, press **CONTINUE** (A key) to accept the PowerLink probe information.

NOTE

If you are using a non-PowerLink probe, access the **APPL SELECT** menu (A key) using the ADV SETUP menu key ()

3. Select the **Smaller Disbonds and Repair Identification** application, and then press  to accept (see Figure 6-30 on page 151).

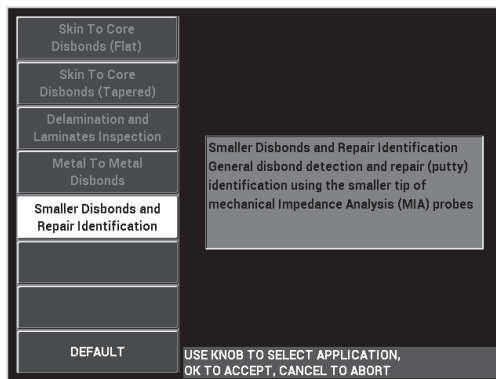





Figure 6-30 The Smaller Disbonds and Repair Identification application

To calibrate the signals

1. Press the DISP/DOTS menu key () once, and then set the **POSITION** (C key) to **CENTER**.
2. Press the ALARM menu key () , and then set the **XY ALM 1** (B key) to **OFF**.
3. Place the probe tip on a good part of the standard, and then press the CAL NULL key () .
4. Lift the probe into the air to observe the dot's movement; if the dot disappears off the screen, press the GAIN key (**dB**), and then use the knob to adjust the dot position so that it remains on the screen (see Figure 6-31 on page 152).

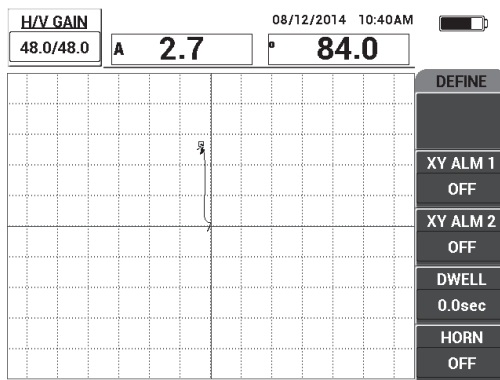



Figure 6-31 Adjusting the dot position

5. Place the probe tip on a good part of the standard, and then press the CAL NULL key () .
6. Slowly scan over a disbond and a repaired area, and then press the FREEZE key () [see Figure 6-32 on page 153].

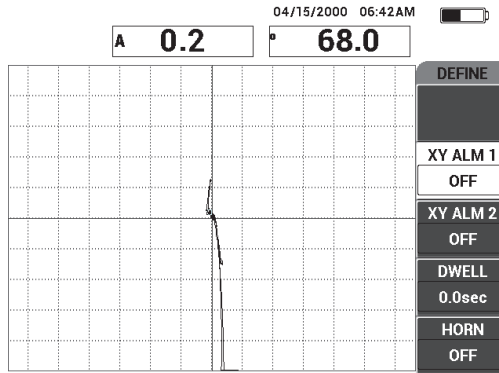



Figure 6-32 The scan over the disbond and repaired area

7. Press the MAIN menu key () , then press **ANGLE** (E key) and adjust the signal angle so that the disbond signal points upwards at 90° (see Figure 6-33 on page 153).

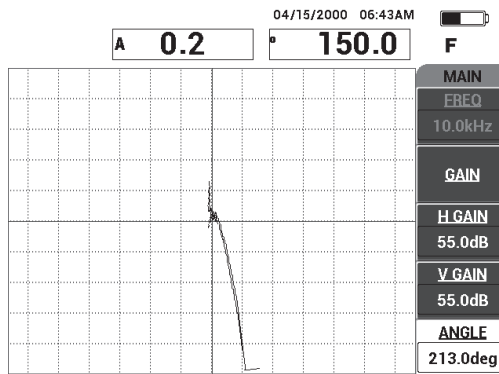

Figure 6-33 Adjusting the signal angle upwards

8. Press the GAIN key (**dB**), and then adjust the signal amplitude so that the disbond signal extends to about 4 divisions away from the null position (crosshairs) [see Figure 6-34 on page 154].

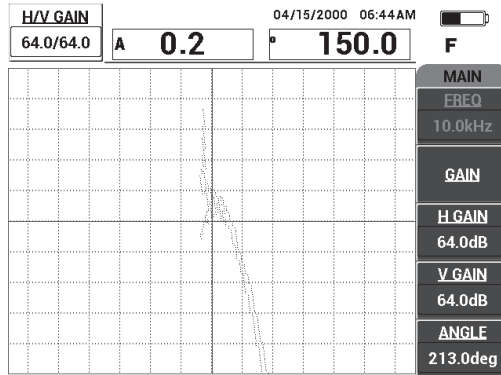

Figure 6-34 Adjusting the signal amplitude

9. Press the FREEZE key (❄️) to unfreeze the acquisition, press the FULL NEXT key (➡️) to display the full screen, and then slowly scan over the disbond and repaired area again (see Figure 6-35 on page 154).

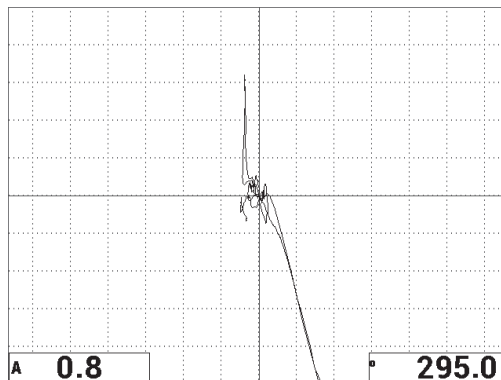

Figure 6-35 The second scan over the disbond and repaired area

To fine-tune the instrument settings

1. Depending on your requirements, set the alarm box parameters, horn, or external horn (louder). For more details about alarms, see “Alarms, Connectivity, and Memory Specifications” on page 225.
2. Depending on your requirements, change your real-time readings.

The default real-time readings display the XY signal’s live amplitude and phase. For information on how to change the real-time readings, see “Displaying Real-Time Readings” on page 66.

The list of all parameters is shown in Figure 6-36 on page 155.

ALL SETTINGS MIA & RESON					
MODE	MIA	FREQ	10.0kHz	XY ALM 1	OFF
PROBE TYPE	MIA	ANGLE	213.0deg	SHAPE	BOX
SERIAL #	R05109	H.GAIN	64.0dB	TOP	100.0%
PRB DRV	MEDIUM	V.GAIN	64.0dB	BOTTOM	50.0%
LP FILTER	30Hz			LEFT	0.0%
				RIGHT	100.0%
DSP MODE	XY FLY DOT	H POS	50%		
GRID	FINE	V POS	50%		
PERSIST	OFF				
D ERASE	OFF				
FILLED SCAN	ON	SCAN ALM	OFF	XY ALM 2	OFF
SCAN TIME	5.0Sec	CHANNEL	AMPLITUDE	SHAPE	CIRCLE
DOT MODE	XY	TOP	75.0%	RADIUS	20.0%
		BOTTOM	25.0%	HORZ	50.0%
				VERT	50.0%

ALL SETTINGS MIA & RESON	
HORN	OFF
DWELL	0.0sec
EXT HORN	OFF
CAP MODE	INSTANT
CAP DLY	10.0sec
RDG1 TYP	A
RDG1 LOC	BOT LEFT
RDG2 TYP	Phase
RDG2 LOC	BOT RIGHT
AOUT PWR	OFF

PRESS [A] FOR FIRST COL. [B] FOR SECOND COL. [C] FOR THIRD COL. [E] FOR NEXT.

PRESS [A] FOR FIRST COL. [B] FOR SECOND COL. [E] FOR PREV.

Figure 6-36 The list of all parameters

6.1.5 Inspecting Metal-to-Metal Bonds — Resonance Technique

The resonance mode is the preferred test mode for inspecting metal-to-metal bonds. The smaller footprint of the resonance probes enables easy access around fasteners. The resonance technique requires a low-viscosity couplant to work properly. While scanning, you should slowly glide the probe and exert low pressure on the probe so that couplant remains between the surface and the probe. This procedure demonstrates how to inspect metal bonds using the resonance mode as a simple go/no-go test.

Inspection materials are shown in Figure 6-37 on page 156.



Figure 6-37 Materials — metal-to-metal bonds using resonance technique

The following products are used in this procedure:

- Metal-to-metal bond demonstration standard; three aluminum plies of 0.5 mm (0.020 in.) aluminum. P/N: NEC-6384 [U8861988]
- Resonance low-viscosity couplant bottle, 118 ml (4 oz). P/N: 3308193 [U8770328]
- Resonance probe cable, 3.35 m (11 ft). P/N: SBM-CR-P6 [U8800059]
- 250 kHz resonance probe. P/N: S-PR-5 [U8010010]

To set the initial BondMaster 600 configuration

1. Connect the probe and the cable to the PROBE connector of the BondMaster 600.
2. When prompted, press **CONTINUE** (A key) to accept the PowerLink probe information.

NOTE

If you are using a non-PowerLink probe, access the **APPL SELECT** menu (A key) using the ADV SETUP menu key ()

3. Select the **Metal To Metal Disbonds** application, and then press ✓ to accept (see Figure 6-38 on page 157).

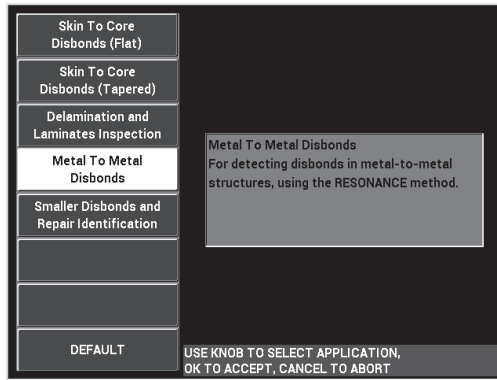



Figure 6-38 The Metal To Metal Disbonds application

4. If the calibration menu does not appear automatically, press and hold the CAL NULL key (CAL .
5. Hold the probe in the air. The BondMaster 600 should automatically pick the best operating frequency for the probe. When in doubt, press **CAL** (C key) or change the **FREQ** (D key) using the knob.
6. Press **DONE** (E key) [see Figure 6-39 on page 157].

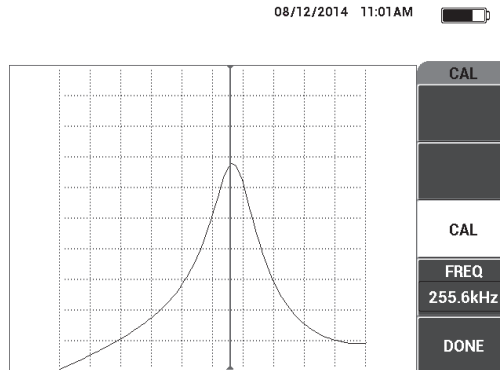



Figure 6-39 The CAL screen

To calibrate the signals

1. Install a backing mat or foam under the standard. Doing so will make the readings more stable.
2. Pour a generous amount of couplant onto the standard.
3. Place the probe on a good area of the standard, and then press the CAL NULL key .
4. Slowly glide the probe over the first disbond and hold it there.
5. Press the DISP/DOTS menu key () twice to display the DOTS screen.
6. Press **STORE NEXT** (A key) to record the first dot (see Figure 6-40 on page 158).

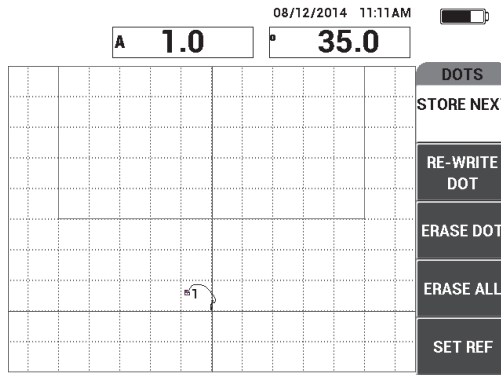

Figure 6-40 The first dot recorded

7. Slowly glide the probe over the second disbond, and then press **STORE NEXT** (A key) to record the second dot (see Figure 6-41 on page 159).

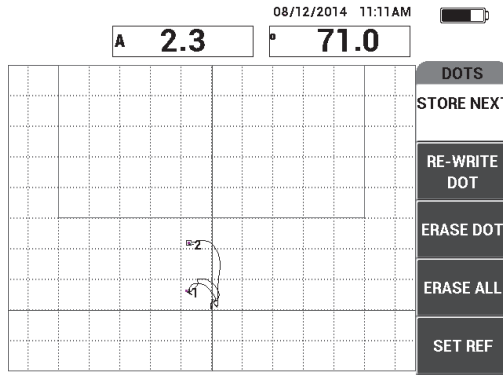



Figure 6-41 The second dot recorded

8. Release the probe, and then press the ERASE key ().
9. Press the MAIN menu key () once to display the **MAIN** menu screen.
10. Adjust the **ANGLE** (E key) as necessary, so that the dots move up in the XY view.
11. Adjust the **GAIN** (B key) to set the higher dot at approximately 90 % of the screen height (see Figure 6-42 on page 159).

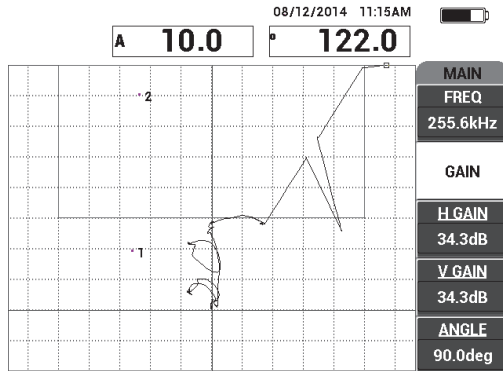



Figure 6-42 The GAIN adjusted to set the higher dot

12. Press the ALARM menu key () twice to display the **XY ALM 1** screen, and then set the **BOTTOM** (C key) to **30 %**.
13. Press the FULL NEXT key () to display the full screen, and then slowly scan over the disbands and ensure that the dots still match the signal (see Figure 6-43 on page 160).

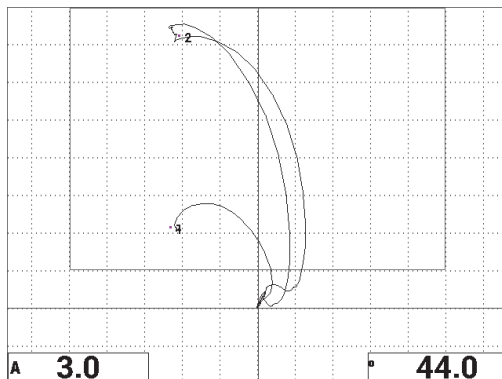

Figure 6-43 The second scan over the disbands

To fine-tune the instrument settings

1. Depending on your requirements, set the alarm box parameters, horn, or external horn (louder). For more details about alarms, see “Alarms, Connectivity, and Memory Specifications” on page 225.
2. Depending on your requirements, change your real-time readings.
The default real-time readings display the XY signal’s live amplitude and phase. For information on how to change the real-time readings, see “Displaying Real-Time Readings” on page 66.
The list of all parameters is shown in Figure 6-44 on page 161.

ALL SETTINGS MIA & RESON					
MODE	RESON	FREQ	255.6kHz	XY ALM 1	POS
PROBE TYPE	250 KHZ	ANGLE	90.0deg	SHAPE	BOX
SERIAL.#	N10151	H.GAIN	34.3dB	TOP	100.0%
PRB DRV	MEDIUM	V.GAIN	34.3dB	BOTTOM	30.0%
LP FILTER	10Hz			LEFT	0.0%
				RIGHT	100.0%
DSP MODE	XY FLY DOT	H POS	50%	XY ALM 2	OFF
GRID	FINE	V POS	20%	SHAPE	CIRCLE
PERSIST	OFF			RADIUS	20.0%
D ERASE	OFF	SCAN ALM	OFF	HORZ	50.0%
FILLED SCAN	ON	CHANNEL	AMPLITUDE		
SCAN TIME	5.0Sec	TOP	75.0%	VERT	70.0%
		BOTTOM	25.0%		

ALL SETTINGS MIA & RESON	
HORN	OFF
DWELL	0.0sec
EXT HORN	OFF
CAP MODE	INSTANT
CAP DLY	10.0sec
RDG1 TYP	A
RDG1 LOC	BOT LEFT
RDG2 TYP	Phase
RDG2 LOC	BOT RIGHT
AOUT PWR	OFF

PRESS [A] FOR FIRST COL., [B] FOR SECOND COL., [C] FOR THIRD COL., [E] FOR NEXT.

PRESS [A] FOR FIRST COL., [B] FOR SECOND COL., [E] FOR PREV.

Figure 6-44 The list of all parameters

6.1.6 Detecting Interply Delamination in Composites — General Procedure Using Resonance Technique

The resonance technique is the recommended method of detecting delamination between composite material layers. The location of the interply delamination (or the thickness of the part) can often be estimated from the signal phase in the XY view. This procedure shows you how to calibrate the resonance mode for use as a typical go/no-go test.

Inspection materials are shown in Figure 6-45 on page 162.



Figure 6-45 Materials — delamination in composites using resonance technique

The following products are used in this procedure:

- CFRP delamination demonstration standard; 10 plies with three 13 mm (0.5 in.) inserts. P/N: NEC-6382 [U8861986]
- Resonance low-viscosity couplant bottle, 118 ml (4 oz). P/N: 3308193 [U8770328]
- Resonance probe cable, 3.35 m (11 ft). P/N: SBM-CR-P6 [U8800059]
- 250 kHz resonance probe. P/N: S-PR-5 [U8010010]

To set the initial BondMaster 600 configuration

1. Connect the probe and the cable to the PROBE connector of the BondMaster 600.
2. When prompted, press **CONTINUE** (A key) to accept the PowerLink probe information.

NOTE

If you are using a non-PowerLink probe, access the **APPL SELECT** menu (A key) using the ADV SETUP menu key ().

- Select the **Delamination and Laminates Inspection** application, and then press ✓ to accept (see Figure 6-46 on page 163).

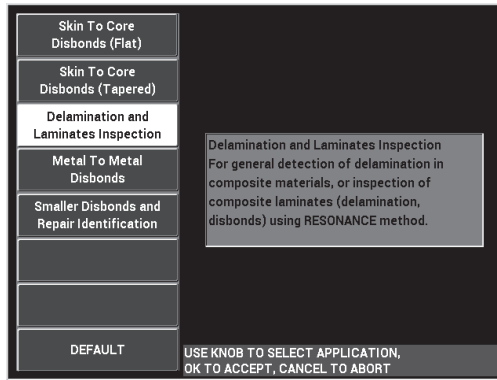



Figure 6-46 The Delamination and Laminates Inspection application

- If the calibration menu does not appear automatically, press and hold the CAL NULL key (CAL .
- Hold the probe in the air. The BondMaster 600 should automatically pick the best operating frequency for the probe. When in doubt, press **CAL** (C key) or change the **FREQ** (D key) using the knob.
- Press **DONE** (E key) [see Figure 6-47 on page 163].

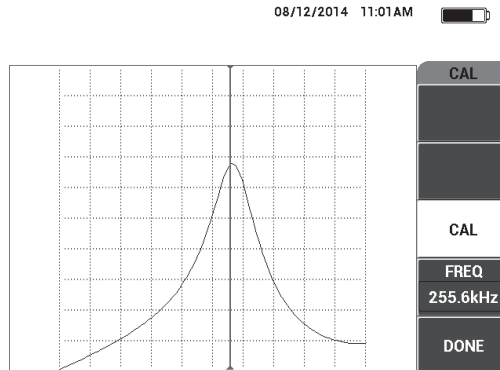



Figure 6-47 The CAL screen

To calibrate the signals

1. Install a backing mat or foam under the standard. Doing so will make the readings more stable.
2. Pour a generous amount of couplant onto the standard.
3. Place the probe on a good area of the standard, and then press the CAL NULL key .
4. Slowly glide the probe over the first disbond and hold it there.
5. Press the DISP/DOTS menu key () twice to display the DOTS screen.
6. Press **STORE NEXT** (A key) to record the first dot (see Figure 6-48 on page 164).

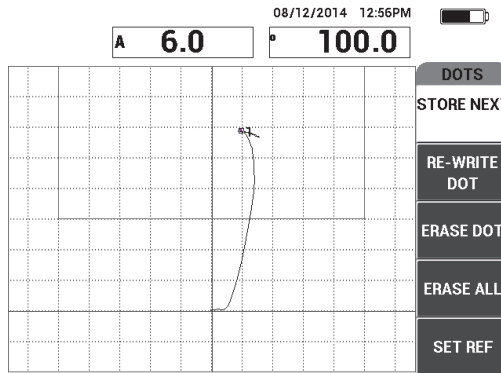

Figure 6-48 The first dot recorded

7. Slowly glide the probe over the second disbond, and then press **STORE NEXT** (A key) to record the second dot (see Figure 6-49 on page 165).

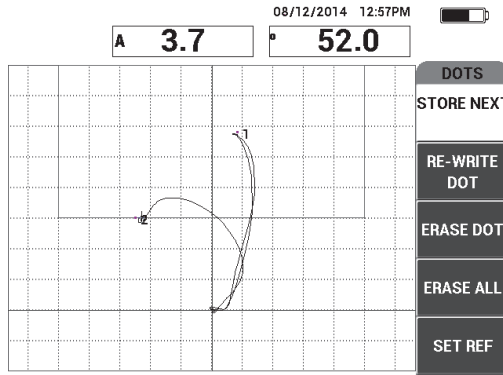

Figure 6-49 The second dot recorded

8. Slowly glide the probe over the third disbond, and then press **STORE NEXT** (A key) to record the third dot (see Figure 6-50 on page 165).

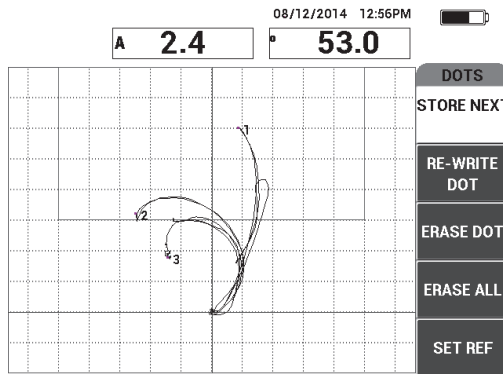



Figure 6-50 The third dot recorded

9. Release the probe, and then press the ERASE key ().
10. Press the MAIN menu key () once to display the **MAIN** menu screen.
11. Adjust the **ANGLE** (E key) as necessary, so that the dots move up in the XY view.

12. Adjust the **GAIN** (B key) to set the highest dot at approximately 90 % of the screen height (see Figure 6-51 on page 166).

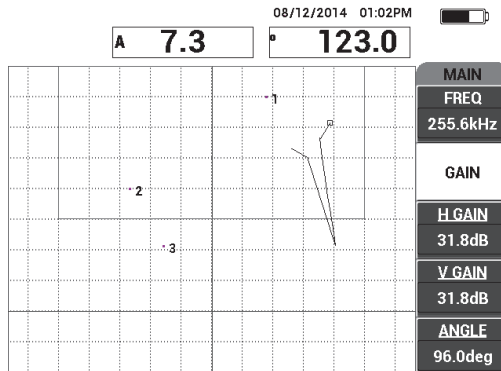

Figure 6-51 The GAIN adjusted to set the highest dot

13. Press the ALARM menu key (🔔) twice to display the **XY ALM 1** screen, and then set the **BOTTOM** (C key) to 30 %.
14. Press the FULL NEXT key (👉) to display the full screen, and then slowly scan over the disbands and ensure that the dots still match the signal (see Figure 6-52 on page 166).

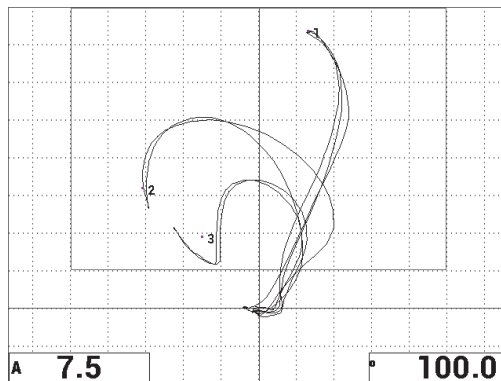



Figure 6-52 The second scan over the disbands

To fine-tune the instrument settings

1. Depending on your requirements, set the alarm box parameters, horn, or external horn (louder). For more details about alarms, see “Alarms, Connectivity, and Memory Specifications” on page 225.
2. Depending on your requirements, change your real-time readings.
The default real-time readings display the XY signal’s live amplitude and phase. For information on how to change the real-time readings, see “Displaying Real-Time Readings” on page 66.

To activate an alternate display

- ◆ Press the RUN key () as necessary to display the amplitude and phase components against time.

This representation is particularly useful when inspecting materials with variations in thickness, because both the phase and amplitude components charts will represent the part thickness (see Figure 6-53 on page 167).

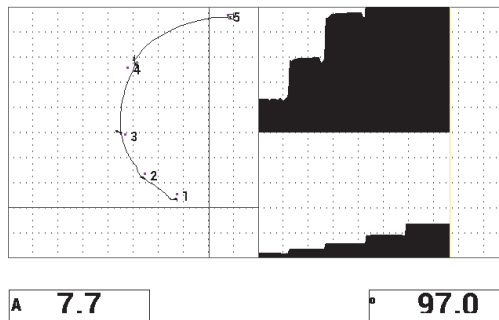

Figure 6-53 The alternate display of amplitude and phase

The list of all parameters is shown in (see Figure 6-54 on page 168).

ALL SETTINGS MIA & RESON					
MODE	RESON	FREQ	255.6kHz	XY ALM 1	POS
PROBE TYPE	250 KHZ	ANGLE	96.0deg	SHAPE	BOX
SERIAL.#	N10151	H.GAIN	31.8dB	TOP	100.0%
PRB DRV	MEDIUM	V.GAIN	31.8dB	BOTTOM	30.0%
LP FILTER	10Hz			LEFT	0.0%
				RIGHT	100.0%
DSP MODE	XY FLY DOT	H POS	50%		
GRID	FINE	V POS	20%		
PERSIST	OFF				
D ERASE	OFF				
FILLED SCAN	ON	SCAN ALM	OFF	XY ALM 2	OFF
SCAN TIME	5.3Sec	CHANNEL	AMPLITUDE	SHAPE	CIRCLE
		TOP	75.0%	RADIUS	20.0%
		BOTTOM	25.0%	HORZ	50.0%
				VERT	70.0%

ALL SETTINGS MIA & RESON	
HORN	OFF
DWELL	0.0sec
EXT HORN	OFF
CAP MODE	INSTANT
CAP DLY	10.0sec
RDG1 TYP	A
RDG1 LOC	BOT LEFT
RDG2 TYP	Phase
RDG2 LOC	BOT RIGHT
AOUT PWR	OFF

PRESS [A] FOR FIRST COL., [B] FOR SECOND COL., [C] FOR THIRD COL., [E] FOR NEXT.

PRESS [A] FOR FIRST COL., [B] FOR SECOND COL., [E] FOR PREV.

Figure 6-54 The list of all parameters

6.2 Advanced Guide for OEM Procedure and Application Development Using the BondMaster 600

This section contains advanced examples that can be used to develop your own inspection procedures.

6.2.1 Analyzing Frequency Response in Honeycomb Composite — Selecting the Best Inspection Frequency Using PC Swept Technique

The pitch-catch (PC) Swept mode of the BondMaster 600 features a new SPECTRUM representation. This representation is useful for understanding the frequency response of a given test specimen, and helps you choose the best operating frequency.

The instructions in this section are intended as guidelines for maximizing your frequency-analysis results. These guidelines are not intended as a direct inspection setup, but rather explain the importance of each parameter or variable.

Inspection materials are shown in Figure 6-55 on page 169.



Figure 6-55 Materials — analyzing frequency response using PC Swept

The following products are used in this procedure:

- Honeycomb composite reference standard: 25 mm (1 in.) thick, twelve 3-ply fiberglass top and bottom skins, Nomex and fiberglass cores. Includes two 25 mm (1 in.) disbonds, two 25 mm (1 in.) delaminations and two 25 mm (1 in.) repairs. P/N: CHR5-1-3 [U8860626]
- Cable for pitch-catch and MIA modes, 1.83 m (6 ft). P/N: SBM-CPM-P11 [U8800058]
- Pitch-catch probe for general use; tip spacing 14 mm. P/N: S-PC-P14 [U8800601]

To set the initial BondMaster 600 configuration

1. Connect the probe and the cable to the PROBE connector of the BondMaster 600.
2. When prompted, press **CONTINUE** (A key) to accept the PowerLink probe information.

NOTE

If you are using a non-PowerLink probe, access the **APPL SELECT** menu (A key) using the ADV SETUP menu key ().

3. Select the **Skin To Core Disbonds (Tapered)** application, and then press ✓ to accept (see Figure 6-56 on page 170).

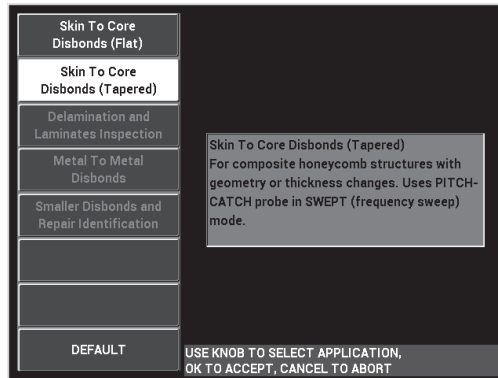

Figure 6-56 The Skin To Core Disbonds (Tapered) application

4. Press the MAIN menu key (🔊) once, and set the **SW. RATE** (E key) to **LOW**. When developing an application or procedure, the lower sweep rate setting usually provides the best results.
5. If necessary, adjust the **START FREQ** (C key) and **STOP FREQ** (D key) values. As a general starting point, values in the range of 5 kHz to 50 kHz are usually very suitable.
6. Press the RUN key (▶) once to display the **SPEC+XY RUN**.
7. Press the MAIN menu key (🔊) again to display the **SPECIAL** screen.

First-Pass Analysis

IMPORTANT

This sub-section shows you how you can use the first probe pass to “clean up” the spectrum view so that subsequently with the second probe pass you can focus only on the useful frequencies. This is particularly important for fiberglass or aluminum skin materials, because they usually return more signals to the pitch-catch probe, which can be misleading when doing the frequency analysis.

To distinguish the useful frequencies from unsuitable frequencies (first probe pass)

1. Place the probe tips on a good part of the standard, then press the GAIN key (**dB**) and adjust the GAIN until the swept figure is contained between two divisions inside the alarm box (see Figure 6-57 on page 171).

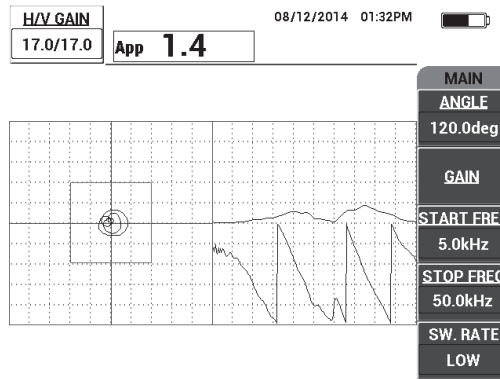



Figure 6-57 The swept figure between two divisions

2. Lift probe into the air and press the CAL NULL key (.
3. Hold the probe still on a good part of the standard, and then press and hold the REF SAVE key () to save the background reference signal (see Figure 6-58 on page 172).

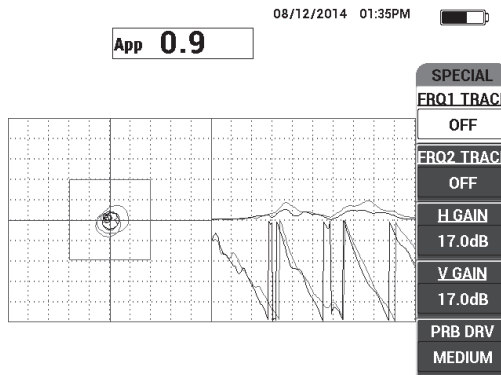

Figure 6-58 The background reference signal

4. Adjust the **FRQ1 TRACK** (A key) or **FRQ2 TRACK** (B key) as necessary, to select (highlight) up to two specific frequencies.
This is useful for identifying the various peaks observed.
5. Slowly scan over defects, and carefully observe the frequency spectrum (right view), in particular the amplitude component (top right) [see Figure 6-59 on page 173].

NOTE

- a) Focus on amplitude *difference* rather than highest peak. Often, the best operating frequency is not the one that provides the highest peak, but the one that provides the highest contrast between a good bond and a defective bond.
- b) Try to identify the minimum and maximum useful frequencies; often, only a smaller portion of the spectrum (usually the lower end) is truly useful. Using the frequency markers, try to locate the valuable “start frequency” and “end frequency” values.
- c) Scan slowly, with a circular motion, because the peaks will vary greatly, depending on the probe position.
- d) Take notes, because working with the spectrum view can be confusing.

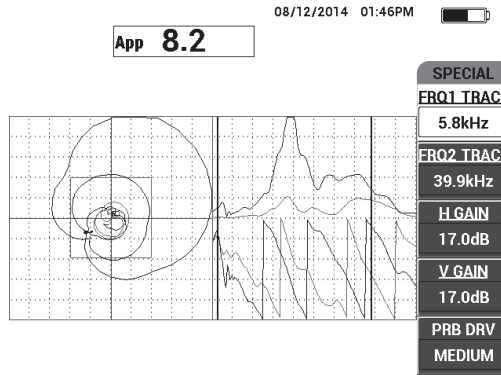



Figure 6-59 The frequency spectrum view (right side of screen)

6. After you have identified the lower and upper limits, press the MAIN menu key () , and then enter these limits as the **START FREQ** and **STOP FREQ** values.

Second-Pass Analysis

To focus on the defects (second probe pass)

- ◆ After you have determined the lower and upper limits of the valuable spectrum, repeat steps 1–6, but this time focus on the various defects.

NOTE

- a) Scan slowly, using a circular motion.
- b) Take notes for every defect, material, frequency evaluated, etc.
- c) Try to find common frequencies that enable you to detect the various defects under various conditions. A “universal” frequency is always better, because it will simplify the test.
- d) The ultimate goal of finding the best test frequencies is to enable you to write your own (very simple) procedure using the PC **RF** or **IMPULSE** method.
- e) The frequency tracking feature actually records the live dot position in a similar way to the pitch-catch RF/IMPULSE mode.

Observe the frequency tracking signal in the XY view to determine whether the selected frequencies will enable an easy test or not (see Figure 6-60 on page 174).

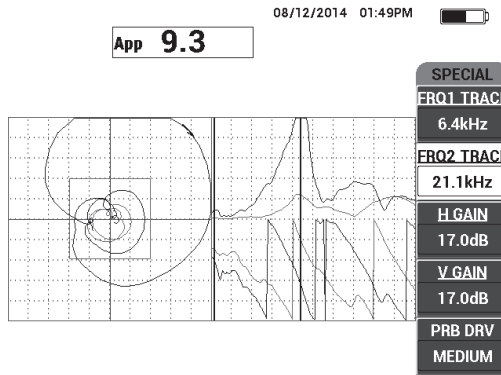

Figure 6-60 The frequency-tracking signal trace

6.2.2 Finding the Best Frequency to Inspect Honeycomb Composite — Mechanical Impedance Analysis (MIA) Technique

The expanded frequency range of the BondMaster PC enables you to use the MIA method at frequencies up to 50 kHz. This procedure explains how to identify the best operating frequencies for writing a MIA procedure.

Inspection materials are shown in Figure 6-61 on page 175.



Figure 6-61 Materials – finding the best frequency using the MIA technique

The following products are used in this procedure:

- Honeycomb composite reference standard: 25 mm (1 in.) thick, twelve 3-ply fiberglass top and bottom skins, Nomex and fiberglass cores. Includes two 25 mm (1 in.) disbands, two 25 mm (1 in.) delaminations and two 25 mm (1 in.) repairs. P/N: CHRS-1-3 [U8860626]
- Cable for pitch-catch and MIA modes, 1.83 m (6 ft). P/N: SBM-CPM-P11 [U8800058]
- Right angle MIA probe, 13 mm (0.5 in.) tip. P/N: S-MP-3 [U8010011]

To set the initial BondMaster 600 configuration

1. Connect the probe and the cable to the PROBE connector of the BondMaster 600.
2. When prompted, press **CONTINUE** (A key) to accept the PowerLink probe information.

NOTE

If you are using a non-PowerLink probe, access the **APPL SELECT** menu (A key) using the ADV SETUP menu key ().

3. Select the **Smaller Disbonds and Repair Identification** application, and then press ✓ to accept (see Figure 6-62 on page 176).

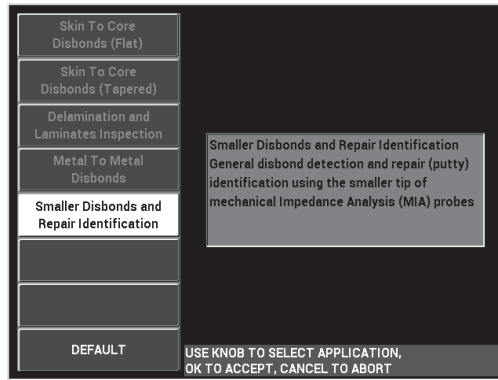

Figure 6-62 The Smaller Disbonds and Repair Identification application

To select the frequency

1. Make sure that you can locate all defects on the reference standard.
2. Press and hold the CAL NULL key ($\overset{\text{CAL}}{\oplus}$) to open the **CAL** (calibration) screen.
3. Adjust the frequency limits as necessary, using the knob.
4. Hold the probe tip over the smaller, or most critical defect, and then press **BAD PART** (E key) [see Figure 6-63 on page 177].

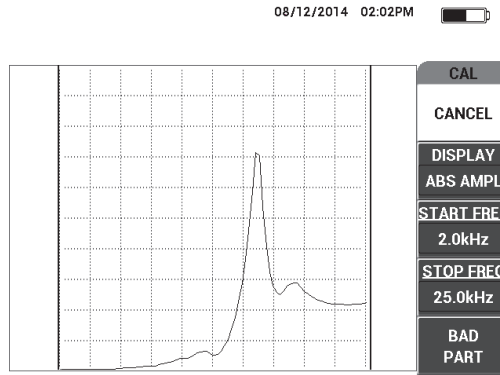

Figure 6-63 The signal for the smaller defect

5. Hold the probe over a defect-free section, and then press **GOOD PART** (E key) [see Figure 6-64 on page 177].

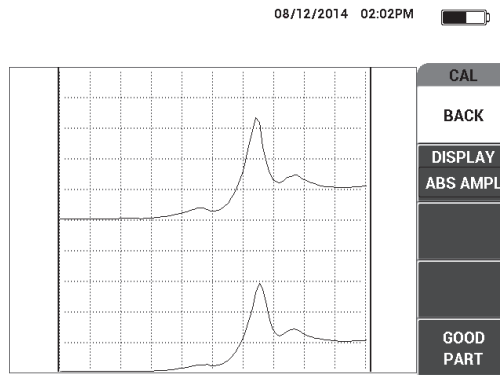

Figure 6-64 The signal for the defect-free zone

6. If necessary, select the best operating frequency for your needs by adjusting the **FREQ** (D key) using the knob (see Figure 6-65 on page 178).
In many situations, the BondMaster 600 automatically picks the best operating frequency. However, for some more complex or noisier applications, it is recommended to manually select the frequency.

NOTE

- a) Prioritize negative peaks over positive peaks.
- b) In case you have multiple peaks, prioritize the first (left) peak over the peaks on the right side.
- c) When in doubt, repeat the frequency selection steps and ensure that you maintain a constant pressure on the probe. If your results were unsatisfactory, this might have been because you did not hold the probe properly.
- d) The use of a probe holder is NOT recommended because it can impact the mechanical impedance of the area being scanned.

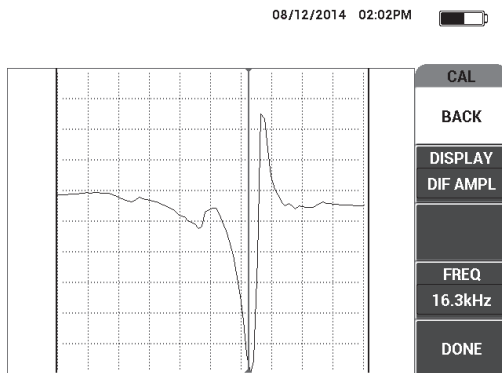

Figure 6-65 Selecting the best operating frequency

7. When you have obtained a satisfactory frequency, press **DONE** (E key).

To calibrate the signals

1. With the frequency properly selected, place the probe on a defect-free portion of the standard and then press the CAL NULL key (\oplus).

- Lift the probe into the air, then press the MAIN menu key (📡) and adjust the **ANGLE** (E key) so that the dot moves upwards in the XY view (see Figure 6-66 on page 179).

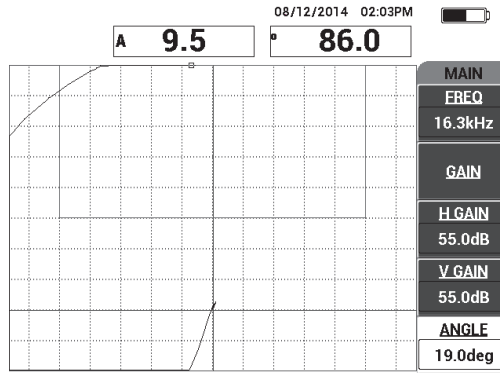

Figure 6-66 Adjusting the angle to move the dot upwards

- If necessary, press the GAIN key (**dB**) and adjust the **GAIN** to keep the air signal dot on the screen (see Figure 6-67 on page 180).

NOTE

The MIA probes exhibit a very high sensitivity from 10 kHz to 18 kHz, and therefore you should expect to use much lower gains; for example, around 25 dB.

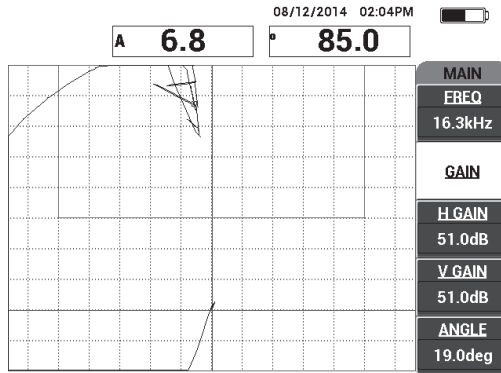

Figure 6-67 The GAIN adjustment to the air signal dot

4. Place the probe tip on a defect-free section, press the CAL NULL key (CAL \oplus) again, and then slowly scan over the defect(s); make sure that the detection is satisfactory, and if necessary, adjust the GAIN, H GAIN, or V GAIN (see Figure 6-68 on page 180).

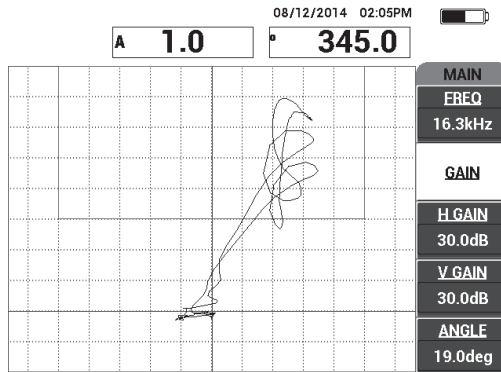

Figure 6-68 The second scan over the defect(s)

7. BondMaster PC Software

The BondMaster PC software enables you to manipulate stored data, capture screen images, upgrade the BondMaster 600 instrument software, create PDFs, issue a command to the instrument, remotely control the instrument, unlock instrument options, and back up and restore the BondMaster 600 instrument settings.

The BondMaster PC software program is included on CD-ROM as a standard accessory with the BondMaster 600. This program allows a PC (computer) to communicate with the BondMaster 600.

7.1 USB Communication

The default communication protocol for the BondMaster 600 is USB 2.0.

7.2 Screen Capture Using BondMaster PC

The BondMaster PC software allows you to capture screen images while operating the BondMaster 600. For details about screen captures performed without BondMaster PC, see “Hidden Function — Screen Capture” on page 80.

To capture a screen image using the BondMaster PC software

1. Start the BondMaster PC software.
2. Connect a USB cable from the PC to the instrument.
3. On the **Device** menu, select **Capture Screen** (see Figure 7-1 on page 182).
The **Capture Screen** dialog box opens (see Figure 7-2 on page 182).

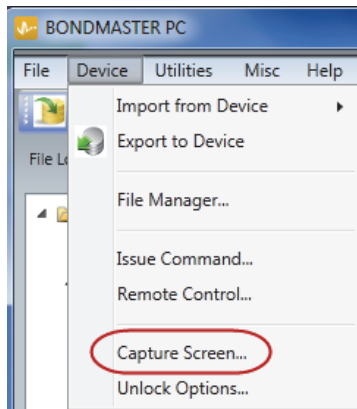

Figure 7-1 BondMaster PC Device menu

4. In the **Capture Screen** dialog box, click **Start Capture** (see Figure 7-2 on page 182).

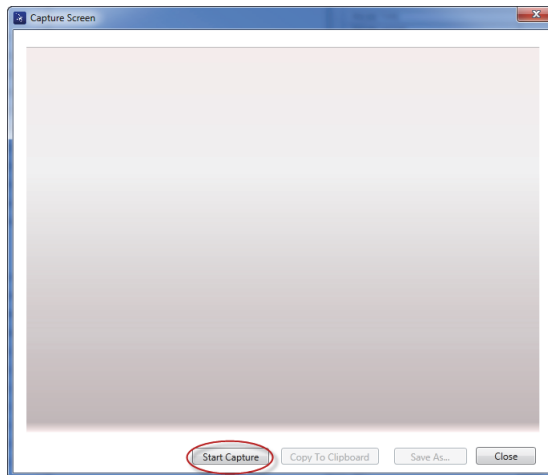

Figure 7-2 The Capture Screen dialog box

5. When the BondMaster PC has obtained the current instrument screen image, proceed as follows:

- ◆ Copy the image to the PC clipboard.
OR
Save the image to the PC hard drive or another memory device.

7.3 Instrument Software Upgrade

BondMaster PC allows you to upgrade the BondMaster 600 instrument software via a USB connection. The instrument software to upgrade must first be downloaded via the internet or other means, and then saved to a file location on the PC.

To upgrade the BondMaster 600 instrument software

1. Press the ADV SETUP menu key () twice.
2. Press the D key to select the **ABOUT** menu (see Figure 7-3 on page 183).

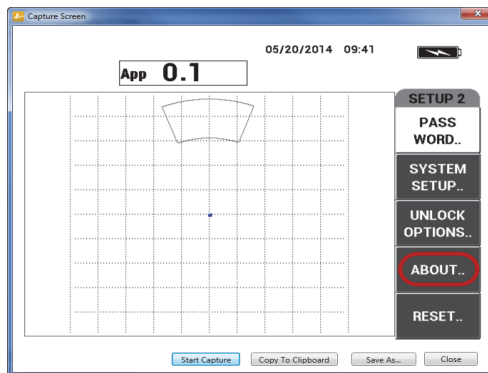

Figure 7-3 The ABOUT menu

3. Press the C key to select the **UPGRADE** menu (see Figure 7-4 on page 184).

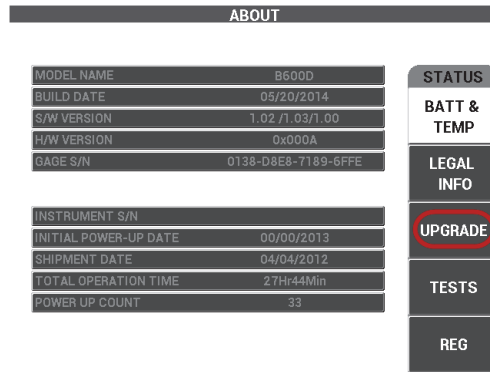

Figure 7-4 The UPGRADE menu

4. Connect the battery charger to the BondMaster 600.
A message is displayed that indicates whether or not the battery charger is connected (see Figure 7-5 on page 184 and Figure 7-6 on page 185).

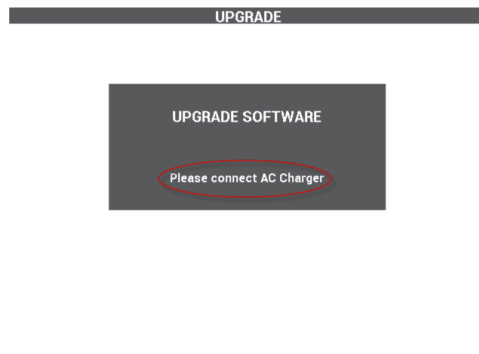

Figure 7-5 The message indicating the battery charger is not connected

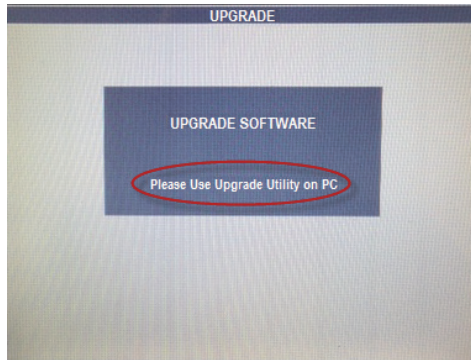

Figure 7-6 The message indicating the battery charger is connected

NOTE

The software upgrade will not proceed until the BondMaster 600 battery charger is connected to the BondMaster 600 instrument.

5. On the BondMaster PC **Utilities** menu, select **Upgrade** (see Figure 7-7 on page 185).
The **Upgrade Device** dialog box opens (see Figure 7-8 on page 186).

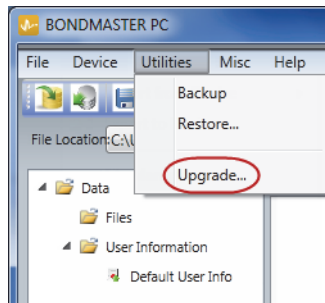

Figure 7-7 The Utilities menu

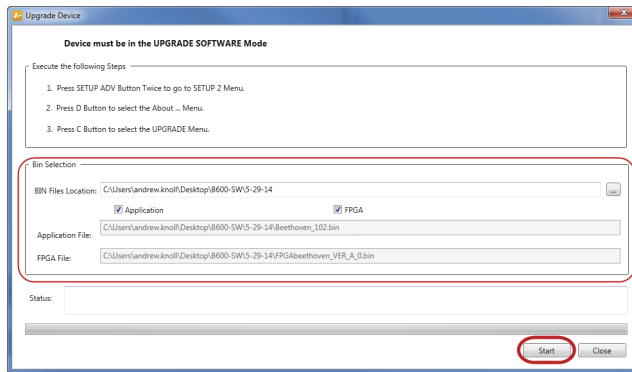

Figure 7-8 The Upgrade Device dialog box

6. Under **Bin Selection** in the **Upgrade Device** dialog box, choose the location of the BondMaster 600 software, and then select **Application** and **FPGA** (see Figure 7-8 on page 186).
7. Click **Start** to begin the update.
8. When the software update process has been completed, turn off the BondMaster 600, and then turn it back on again to activate the upgrade.

7.4 PDF Creation

BondMaster PC allows you to export inspection reports to a PC hard drive or memory device. You can either create an individual PDF file from selected data or export all data as a series of PDF files.

If you select the **Export All Files As Adobe Acrobat (PDF)** option, all stored data on the BondMaster 600 instrument will automatically be selected and used to create individual PDF files that will be saved in a specified location. At the end of this process, the individual PDF files may be reviewed and printed using Adobe Acrobat or equivalent software. It is important to choose the destination folder (to which the files are to be exported) before exporting data in a PDF file.

To create a single PDF file from selected data

- ◆ Select the file in the left pane of the BondMaster PC window (see Figure 7-9 on page 187), and then select **Export As > PDF** (see Figure 7-10 on page 187).

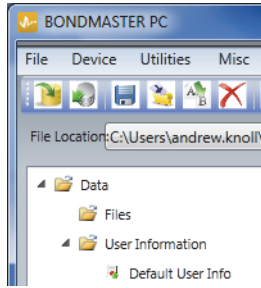

Figure 7-9 Files in the left pane of the BondMaster PC window

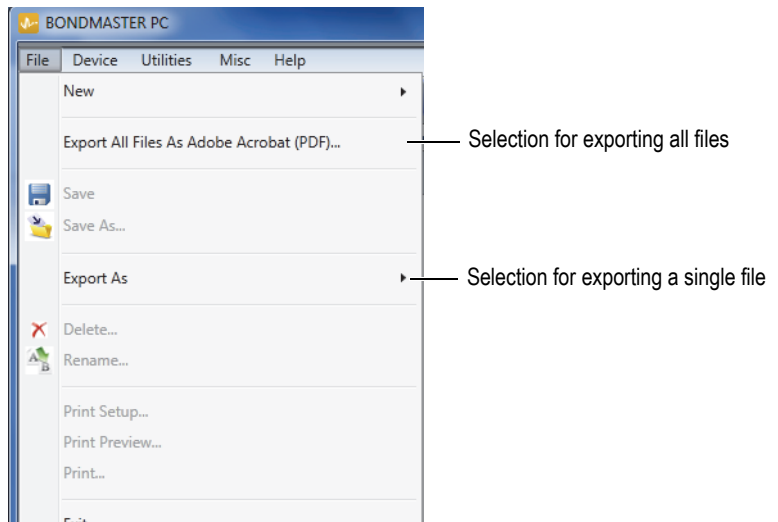

Figure 7-10 The File menu

To export all data using the Export All Files As Adobe Acrobat (PDF) option

- ◆ On the BondMaster PC File menu, select **Export All Files As Adobe Acrobat (PDF)** [see Figure 7-10 on page 187].

7.5 Commands

BondMaster PC lets you issue single read, write, or execute commands.

To view the full list of commands

- ◆ On the **Help** menu, select **Remote Command** (see Figure 7-11 on page 188).
The command list opens in a separate window using the PC's default software for viewing PDF files.

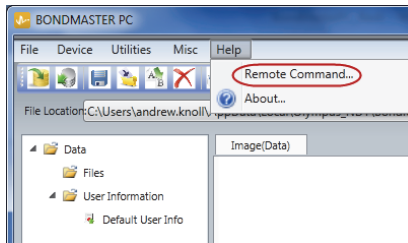

Figure 7-11 Selecting the Remote Command

To issue remote commands

1. On the **Device** menu, select **Issue Command** (see Figure 7-12 on page 188).
The **Issue Command** dialog box opens (Figure 7-13 on page 189).

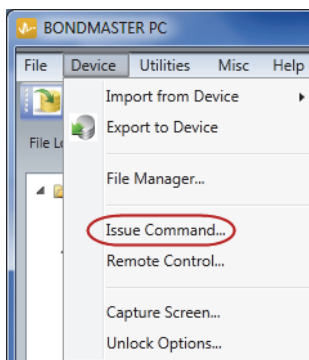

Figure 7-12 The Device menu — Issue Command

2. In the **Issue Command** dialog box, enter a command (see Figure 7-13 on page 189).

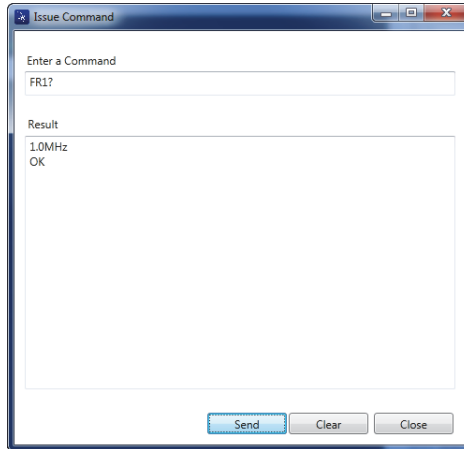

Figure 7-13 The Issue Command dialog box

NOTE

Commands may be read (R), written (W), or executed (X). Table 5 on page 190 lists the commands and the format in which they must be written.

3. In the **Issue Command** dialog box, click **Send** (see Figure 7-13 on page 189).
OR
Press Enter on your PC keyboard.

The BondMaster 600 remote command convention is as follows:

- Read (R) commands end with “?”
Example: ANG?
- Write (W) commands include “=”, followed by a value, with no spaces
Example: ANG=45
- Execute (X) commands include only the command
Example: DLB

NOTE

All commands end with a Carriage Return and Line Feed (entered as “\r\n”). Any space in a Write command should be replaced with an underscore character. For example, for FRQ NEG, use FRQ_NEG.

Table 5 BondMaster 600 remote commands

Command	Description	R/W/X	Range / valid strings	
			Min.	Max.
ADW	Alarm Dwell	R/W	0.000	10.000
ANG	Angle 1	R/W	0.000	359.900
ANI	Angle Step Increment	R	0.100	N/A
ASE	Sweep Erase	R/W	ON/OFF	
AST	Auto Sweep Time	R/W	0.005	10.000
AUE	Auto Erase After Null	R/W	ON/OFF	
ALC	Alarm Condition	R	ON/OFF	
ALMXY1	Alarm Type 1	R/W	OFF/FRQ_NEG/FRQ_POS	
ALMXY1SHAPE	Alarm Shape 1	R/W	BOX/SECTOR/CIRCLE	
ALMXY1BTOP	Alarm 1 Box Top	R/W	0.0	100.0
ALMXY1BBOT	Alarm 1 Box Bottom	R/W	0.0	100.0
ALMXY1BLEFT	Alarm 1 Box Left	R/W	0.0	100.0
ALMXY1BRIGHT	Alarm 1 Box Right	R/W	0.0	100.0
ALMXY1SIDIA	Alarm 1 Sector Inner Diameter	R/W	7.0	263.0

Table 5 BondMaster 600 remote commands (*continued*)

Command	Description	R/W/X	Range / valid strings	
			Min.	Max.
ALMXY1SODIA	Alarm 1 Sector Outer Diameter	R/W	7.0	263.0
ALMXY1SSANG	Alarm 1 Sector Start Angle	R/W	0.0	359.0
ALMXY1SEANG	Alarm 1 Sector End Angle	R/W	0.0	359.0
ALMXY1CRAD	Alarm 1 Circle Radius	R/W	0.0	50.0
ALMXY1CHOR	Alarm 1 Circle Horizontal	R/W	0.0	99.5
ALMXY1CVER	Alarm 1 Circle Vertical	R/W	0.0	99.5
ALMXY2	Alarm Type 2	R/W	OFF/FRQ_NEG/FRQ_POS	
ALMXY2SHAPE	Alarm Shape 2	R/W	BOX/SECTOR/CIRCLE	
ALMXY2BTOP	Alarm 2 Box Top	R/W	0.0	100.0
ALMXY2BBOT	Alarm 2 Box Bottom	R/W	0.0	100.0
ALMXY2BLEFT	Alarm 2 Box Left	R/W	0.0	100.0
ALMXY2BRIGHT	Alarm 2 Box Right	R/W	0.0	100.0
ALMXY2SIDIA	Alarm 2 Sector Inner Diameter	R/W	7.0	263.0
ALMXY2SODIA	Alarm 2 Sector Outer Diameter	R/W	7.0	263.0
ALMXY2SSANG	Alarm 2 Sector Start Angle	R/W	0.0	359.0

Table 5 BondMaster 600 remote commands (continued)

Command	Description	R/W/X	Range / valid strings	
			Min.	Max.
ALMXY2SEANG	Alarm 2 Sector End Angle	R/W	0.0	359.0
ALMXY2CRAD	Alarm 2 Circle Radius	R/W	0.0	50.0
ALMXY2CHOR	Alarm 2 Circle Horizontal	R/W	0.0	99.5
ALMXY2CVER	Alarm 2 Circle Vertical	R/W	0.0	99.5
ALMSCN	Alarm Type Scan	R/W	OFF/FRQ_NEG/FRQ_POS	
ALMSCNCHN	Alarm Scan Channel	R/W	N/A	N/A
ALMSCNTOP	Alarm Scan Top	R/W	N/A	N/A
ALMSCNBOT	Alarm Scan Bottom	R/W	N/A	N/A
ALMSCPC	Alarm Type Spectrum	R/W	OFF/FRQ_NEG/FRQ_POS	
ALMSCPCCHN	Alarm Spectrum Channel	R/W	AMPLITUDE/PHASE	
ALMSCPCTOP	Alarm Spectrum Top	R/W	0.0	100.0
ALMSCPCBOT	Alarm Spectrum Bottom	R/W	0.0	100.0
ALMSCPCLEFT	Alarm Spectrum Left	R/W	0.0	100.0
ALMSCPCRIGHT	Alarm Spectrum Right	R/W	0.0	100.0
ALMR	Alarm Type RF	R/W	OFF/FRQ_NEG/FRQ_POS	

Table 5 BondMaster 600 remote commands (continued)

Command	Description	R/W/X	Range / valid strings	
			Min.	Max.
ALMRFTOP	Alarm RF Top	R/W	0.0	100.0
ALMRFBOT	Alarm RF Bottom	R/W	0.0	100.0
BAT	Predicted Batt Capacity	R	0	100
BATT	Predicted Batt Capacity	R	0	100
BCP	Battery Charger Present	R	TRUE/FALSE	
BMP	Screenshot	X	N/A	N/A
CCT	Capture Time	R/W	2.5	120.0
CDM	Cal Display Mode	R/W	ABS_AMPL, ABS_PHAS, DIF_AMPL or DIF_PHAS	
CLB	Color Brightness	R/W	0, 25, 50, 75, 100	
CSH	Color Scheme	R/W	DEFAULT, OUTDOORS, RED, GREEN, BLUE, PINK, CLASS, OFFICE	
CNL	Set Continuous Null	R/W	OFF/0.2 Hz/0.5 Hz/1.0 Hz	
CTE	Display Erase Time	R/W	0.0	60.0
CYC	Cycles	R/W	1	10
DAL	Data Location	R/W	1	# Entries in Datalogger
DAN	Data Name	R/W	Valid name in Datalogger	
DAS	Up/Download Data Only	R	N/A	N/A

Table 5 BondMaster 600 remote commands (continued)

Command	Description	R/W/X	Range / valid strings	
			Min.	Max.
DAT	Clock Date	R	MM/DD/YYYY DD/MM/YYYY Depending upon System Setup	
DAY	Day	R/W	1	31
DCM	Capture Mode	R/W	INSTANT/DELAYED	
DEF	Data Status - Block	R	N/A	N/A
DLB	Datalogger Backup	X	N/A	N/A
DLR	Datalogger Restore	X	N/A	N/A
DSC	Powerlink Probe Description	R	Probe Description String	
DLRC	Number Backup Files on External SD Card	R	0	502
ERS	Screen Erase	X	N/A	N/A
EXH	External Horn	R/W	ON/OFF	
FILEREADXML?\2	Read File in XML Format From Gage	R	N/A	N/A
FILEWRITEXML=\2	Write XML File to Gage	W	N/A	N/A
F1T	Frequency 1 Tracking	R/W	OFF or a value between the start and stop frequencies	

Table 5 BondMaster 600 remote commands (continued)

Command	Description	R/W/X	Range / valid strings	
			Min.	Max.
F2T	Frequency 2 Tracking	R/W	OFF or a value between the start and stop frequencies	
FLO	Frequency Low Pass	R/W	10.0	2500.0
FRQ	Frequency 1	R/W	10	12000000
FRZ	Screen Freeze	X	N/A	N/A
FSP	Stop Frequency	R/W	PC(RF): 1.0–50.0 SWEPT: 5.0–100.0 MIA: 1.0–10.0 RESON: 1.0–500.0	
FST	Start Frequency	R/W	PC(RF): 1.0–50.0 SWEPT: 5.0–100.0 MIA: 1.0–10.0 RESON: 1.0–500.0	
GMD	Gage Mode	R/W	PC_(RF) PC_SWEPT MIA RESON	
GN1	Frequency Gain 1	R/W	0.0	100.0
GRT	Grid Type	R/W	OFF 10×10 FINE COARSE WEB	
GTP	Gate Position	R/W	AUTO, or 0–7920.0	

Table 5 BondMaster 600 remote commands (continued)

Command	Description	R/W/X	Range / valid strings	
			Min.	Max.
GTT	Gate Type	R/W	SINGLE DUAL	
GAGECONFIGDATE	Gage Shipment Date	R	MM/DD/YYYY	
GAGEINITDATE	Gage Initial Power Up Date	R	MM/DD/YYYY	
HGN	Freq 1 Hor Gain	R/W	0.0	100.0
HPO	Horizontal Position	R/W	-16	116
HR.	Hours	R	0	23
HRN	Alarm Horn Volume	R/W	ON/OFF	
HWV	Hardware Version	R	DxDDDD, where D is 0-9, A-F	
HW	Hardware Version	R	DxDDDD, where D is 0-9, A-F	
ISN	Instrument Serial Number	R	N/A	N/A
KEY	Key Command	W	MAIN/DISPLAY/ALARM/MEMORY/SETUP/NUL/ERASE/SAVE/FREEZE/AUTO-LIFT/REF/GAIN/RUN/ENTER/ESCAPE/NEXT/FULL_NEXT/A/B/C/D/E	
KNOB	Knob Command	W	CCW/CW/UP/DOWN	
KER	Erase Display	X	N/A	N/A

Table 5 BondMaster 600 remote commands (*continued*)

Command	Description	R/W/X	Range / valid strings	
			Min.	Max.
LAN	Language	R/W	GERMAN/JAPANESE/ CHINESE/RUSSIAN/ SWEDISH/ITALIAN/ PORTUGUESE/ NORWEGIAN/ HUNGARIAN/POLISH/ DUTCH/ CZECH	
LDN	Last Filled Data Loc	R	Max. number of files	
LPN	Last Filled Data Loc	R	Max. number of files	
LNS	Powerlink Status	R	N/A	N/A
MIN	Minutes	R/W	0	59
MON	Month	R/W	1	12
MPC	Powerlink Probe Class	R	String describing class	
MPD	Powerlink Probe Mode	R	String describing mode	
MPS	Powerlink Probe S/N #	R	String of Serial Number	
NAM	Instrument Name	R	B600/B600M	
OPTIONSKEY	Set Option Key	W	String with Valid Code	
PCM	Radix Point	R/W	PERIOD (.) / COMMA (,)	
PDR	Probe Drive	R/W	LOW/MEDIUM/HIGH	
PEF	Program Status	R	N/A	N/A
PGL	Program Location	R	Selected file name	

Table 5 BondMaster 600 remote commands (continued)

Command	Description	R/W/X	Range / valid strings	
			Min.	Max.
PGM	Up/Download Program	R/W	N/A	N/A
PGN	Program Name	R/W	Selected file name	
PRE	Pre Amplifier	R/W	ON/OFF	
POWERUP	Total Operation Time	R	Number	
PRINTSCREEN	Screenshot	R	N/A	N/A
REC	Record	R/W	0.1	60.0
RDI	Instrument Battery Current	R	N/A	N/A
RDV	Instrument Battery Voltage	R	N/A	N/A
RLK	Lock	R	ON/OFF	
RT1	Reading 1 Type	R/W	OFF AMP_VMAX VP-P HP-P Phase Amp_p-p	
RT2	Reading 2 Type	R/W	OFF AMP_VMAX VP-P HP-P Phase Amp_p-p	

Table 5 BondMaster 600 remote commands (*continued*)

Command	Description	R/W/X	Range / valid strings	
			Min.	Max.
RL1	Reading 1 Location	R/W	TOP_LEFT TOP_RIGHT LEFT RIGHT BOT_CNTR BOT_RIGHT	
RL2	Reading 2 Location	R/W	TOP_LEFT TOP_RIGHT LEFT RIGHT BOT_CNTR BOT_RIGHT	
RUNTIME	Total Run Time	R	N/A	N/A
SCT	Scan Time	R/W	N/A	N/A
SEC	Seconds	R/W	0	59
SNO	Gage Serial Number	R	XXXX-XXXX-XXXX-XXXX where X is 0–9, A–F	
SRT	Swept Rate	R/W	LOW MEDIUM HIGH	
SW	Software Version	R	N/A	N/A
TIM	Clock Time	R	XX:XX	
TGT	Gate Position	R/W	0	59
TMD	Trace Mode	R/W	DOT/BOX	
TMW	Time Window	R/W	ON/OFF	

Table 5 BondMaster 600 remote commands (continued)

Command	Description	R/W/X	Range / valid strings	
			Min.	Max.
UI1	User Info 1	R/W	Max 40 Characters – No spaces Use "{" character for space	
UI2	User Info 2	R/W	Max 40 Characters – No spaces Use "{" character for space	
UI3	User Info 3	R/W	Max 40 Characters – No spaces Use "{" character for space	
UI4	User Info 4	R/W	Max 40 Characters – No spaces Use "{" character for space	
UI5	User Info 5	R/W	Max 40 Characters – No spaces Use "{" character for space	
UI6	User Info 6	R/W	Max 40 Characters – No spaces Use "{" character for space	
UI7	User Info 7	R/W	Max 40 Characters – No spaces Use "{" character for space	
UI8	User Info 8	R/W	Max 40 Characters – No spaces Use "{" character for space	
UI9	User Info 9	R/W	Max 40 Characters – No spaces Use "{" character for space	

Table 5 BondMaster 600 remote commands (continued)

Command	Description	R/W/X	Range / valid strings	
			Min.	Max.
UI10	User Info 10	R/W	Max 40 Characters – No spaces Use “{” character for space	
UI11	User Info11	R/W	Max 40 Characters – No spaces Use “{” character for space	
UI12	User Info 12	R/W	Max 40 Characters – No spaces Use “{” character for space	
UI13	User Info 13	R/W	Max 40 Characters – No spaces Use “{” character for space	
UI14	User Info 14	R/W	Max 40 Characters – No spaces Use “{” character for space	
UI15	User Info 15	R/W	Max 40 Characters – No spaces Use “{” character for space	
VAP	Variable Persistence	R/W	0.0	10.0
VER	Software Version	R	N/A	N/A
VGN	Freq 1 Vert Gain	R/W	0.0	60.0
VPO	Vertical Position	R/W	0	100
VER_PIC	PIC Version	R	N/A	N/A
WD1	Width 1	R/W	360	10000
YR	Year	R/W	2013	2100

7.6 Remote Control

The BondMaster PC software allows you to remotely control the BondMaster 600. This is especially useful if the instrument is being used in hot cell areas (shielded nuclear radiation containment chambers) or for training purposes.

You can enable the BondMaster PC software's remote control function by clicking **Remote Control** in the **Device** menu (see Figure 7-12 on page 188). The software's **Remote Command** dialog box will then display an image of the front face of the BondMaster 600, including its control buttons and display. You can then control the instrument in the same way as you would if it were in front of you (see Figure 7-14 on page 203).

NOTE

To display the instrument screen, you must first click **Refresh Screen** in the **Remote Command** dialog box (see Figure 7-14 on page 203). For simultaneous setting verification, use the BondMaster 600 display or an external monitor.



Figure 7-14 The Remote Command dialog box

Knob Function in Remote Control Operation

In remote control mode, the knob is separated into two regions. Clicking the top half of the knob increases setting values and clicking the bottom half of the knob decreases setting values (see Figure 7-15 on page 204).

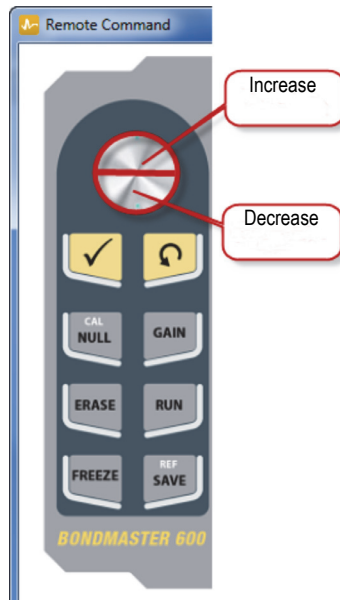

Figure 7-15 Knob functions

7.7 File Manager

The BondMaster PC software's File Manager lets you rename, delete, and recall files that are stored on the BondMaster 600.

To access the File Manager

- ◆ On the BondMaster PC software **Device** menu, select **File Manager** (see Figure 7-16 on page 205).
The **Manage File** dialog box appears (see Figure 7-17 on page 205).

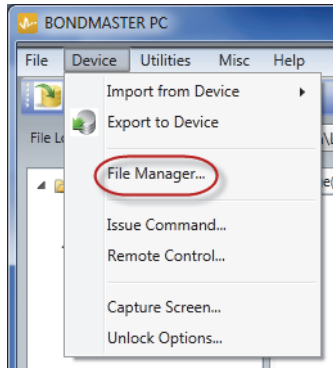

Figure 7-16 The File Manager command

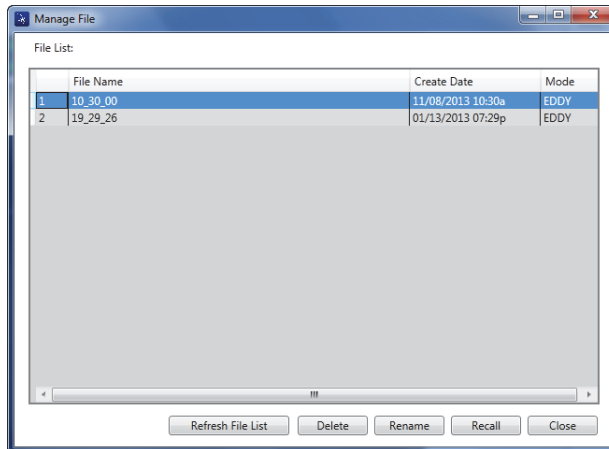

Figure 7-17 The Manage File dialog box

The following functions are available:

- **Delete** — delete files on the BondMaster 600 instrument.
- **Rename** — rename files on the BondMaster 600 instrument, which is especially useful when naming files related to a specific inspection or customer.
- **Recall** — recall a file on the BondMaster 600 instrument.
- **Refresh File List** — refresh the file list in the BondMaster PC software.

To delete a file on the BondMaster 600

1. In the **Manage File** dialog box, choose the file to be deleted, and then click **Delete** (see Figure 7-17 on page 205).

The **Confirmation** dialog box appears, asking you to confirm that you want to delete the file on the device (see Figure 7-18 on page 206).

2. Click **Yes** to confirm file deletion.
OR
Click **No** to cancel the file deletion.

NOTE

If you click **Yes** to confirm file deletion in the **Confirmation** dialog box, the file is permanently deleted, and it cannot be retrieved.

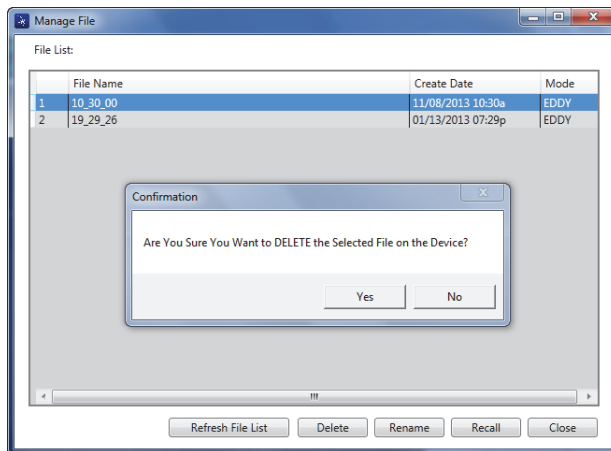

Figure 7-18 The Confirmation dialog box for file deletion

To rename a file on the BondMaster 600

1. In the **Manage File** dialog box, choose the file to be renamed, and then click **Rename** (see Figure 7-17 on page 205).

The **Rename** dialog box opens (see Figure 7-19 on page 207).

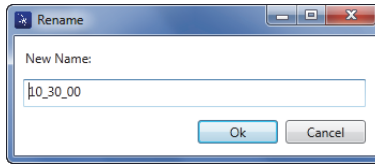

Figure 7-19 The Rename dialog box

2. In the **Rename** dialog box, enter the new file name.
By default, the BondMaster 600 includes the military time stamp in the file name, in HH_MM_SS (Hour_Minute_Second) format.
3. Click **OK** to save the new file name.

To recall a file on the BondMaster 600

1. In the **Manage File** dialog box, choose the file to be recalled, and then click **Recall** (see Figure 7-17 on page 205).

The **Confirmation** dialog box appears, asking you to confirm that you want to recall the selected file (see Figure 7-20 on page 207).

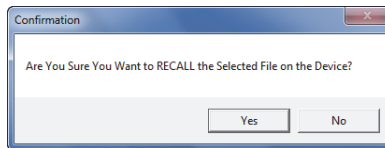

Figure 7-20 Message asking you to confirm the recall

2. Click **Yes** to confirm the file recall.
OR
Click **No** to cancel the file recall.

NOTE

If you click **Yes** to recall a stored file on the device, all previous settings will be overwritten; this cannot be undone.

To refresh the program file list

- ◆ In the **Manage File** dialog box, click **Refresh File List** (see Figure 7-17 on page 205).

7.8 Unlock Options

BondMaster PC enables the BondMaster 600 software to be upgraded via a license key, which is available for purchase from Evident. All BondMaster 600 instrument models have identical hardware capable of full functionality. You can easily upgrade your instrument model's functionality using the BondMaster PC software's **Unlock Options**; it is not necessary to send the instrument to the factory for upgrade.

To unlock options

1. On the BondMaster PC software **Device** menu, select **Unlock Options** (see Figure 7-21 on page 208).

The **Unlock Options** dialog box opens (see Figure 7-22 on page 209).

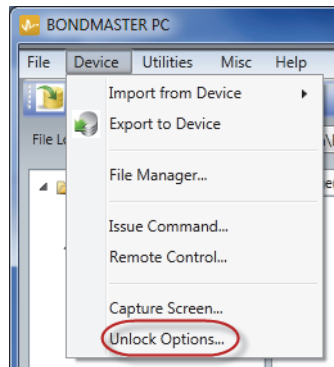

Figure 7-21 The Unlock Options command

2. In the **Unlock Options** dialog box, enter the license key, and then click **OK**.

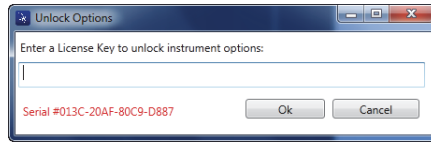

Figure 7-22 The Unlock Options dialog box

3. Turn off, and then turn on the BondMaster 600.
After cycling the power, the BondMaster 600 instrument features are unlocked and ready for use.

7.9 Backup

The BondMaster PC software allows you to easily back up and clone your BondMaster 600 files. The backup file is stored externally on the microSD memory card of the BondMaster 600 being backed up.

To back up a BondMaster 600

1. Make sure that a microSD card is inserted in the BondMaster 600 (see Figure 7-23 on page 210).

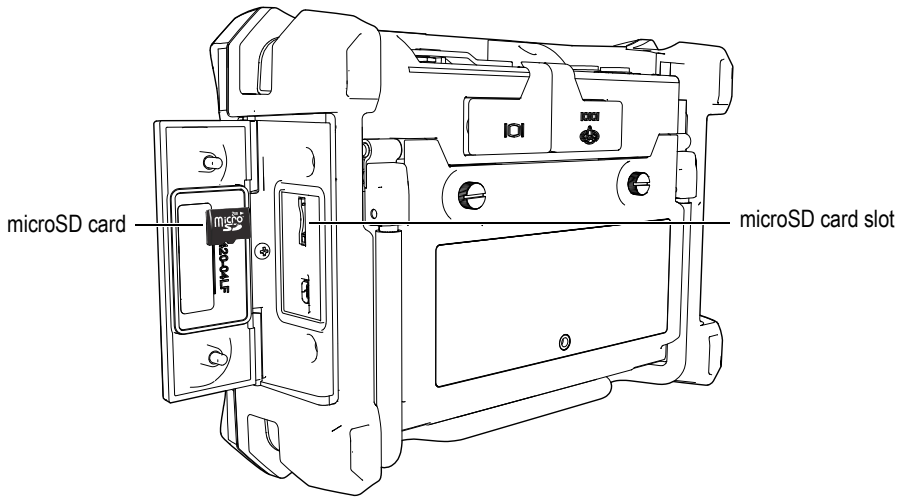

Figure 7-23 The microSD card location

2. On the BondMaster PC software **Utilities** menu, select **Backup** (see Figure 7-24 on page 210).
The **Backup** dialog box appears (see Figure 7-25 on page 211).

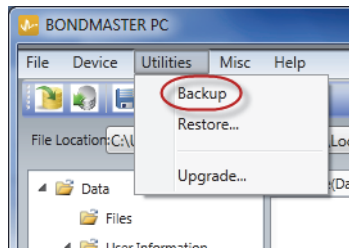

Figure 7-24 The Backup command

3. In the **Backup** dialog box, click **Start**.

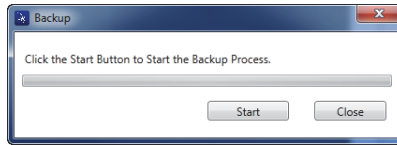

Figure 7-25 The Backup dialog box (start)

4. When the **Confirmation** dialog box appears (see Figure 7-26 on page 211), click **OK** to start the backup process.

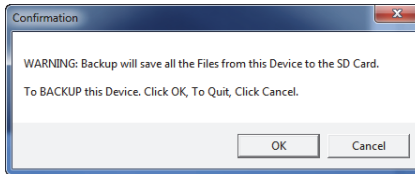

Figure 7-26 The Confirmation dialog box to confirm backup start

5. When the backup has been completed, click **Close** (see Figure 7-27 on page 211).

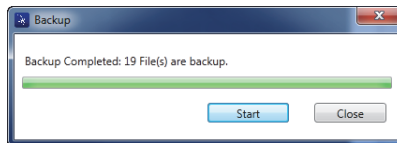

Figure 7-27 The Backup dialog box (complete)

7.10 Restore

The BondMaster PC software allows you to easily restore and clone your BondMaster 600 files using a previously created backup file on the external microSD memory card of the instrument. This backup file is stored separately from the internal storage of the instrument so that it can overwrite (replace) the internally stored information, if necessary. The instrument files can also be cloned using this backup file to create an exact copy, which can then be transferred from one instrument to another.

To restore a BondMaster 600

1. Make sure that a microSD card is inserted in the BondMaster 600 (see Figure 7-23 on page 210).
2. On the BondMaster PC software **Utilities** menu, select **Restore** (see Figure 7-28 on page 212).

The **Restore** dialog box appears (see Figure 7-29 on page 212).



Figure 7-28 The Restore command

3. In the **Restore** dialog box, click **Start**.

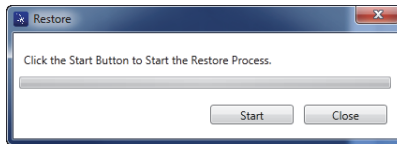

Figure 7-29 The Restore dialog box (start)

4. When the **Confirmation** dialog box appears (see Figure 7-30 on page 212), click **OK** to start the restore process.

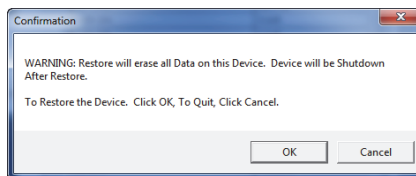

Figure 7-30 The Confirmation dialog box to confirm the restore start

NOTE

Restoring erases all contents of the internal memory and replaces it with the data contained on the external microSD card.

5. When the restore process has been completed, click **Close** (see Figure 7-31 on page 213).

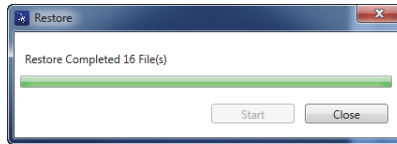

Figure 7-31 The Restore dialog box (complete)

8. Maintenance and Troubleshooting

The BondMaster 600 composite bond tester is an industrial quality electronic instrument that requires very little maintenance. Most troubleshooting and maintenance procedures may be performed by the user. However, if problems persist, contact Evident for technical assistance.

8.1 Lithium-Ion Battery

Under normal operating conditions, the BondMaster 600 can operate on battery power for at least 8 hours between charges (for standard operation). As the battery power depletes, the percentage of remaining battery life is displayed on the battery indicator. When the battery charge becomes insufficient, the BondMaster 600 automatically turns off to prevent damage to the battery. Recharge the battery using the charger and power cord supplied with the instrument.

Charging the Battery

The charger/adaptor indicator light (battery charge LED) illuminates red while the battery is charging, and turns green when the battery is fully charged. The approximate recharge time is two hours to three hours.

Replacing the Battery

Rechargeable batteries lose their ability to hold a full charge after several hundred recharges. For more information on installing and replacing the battery, see “Lithium-Ion Battery” on page 42 and “Alkaline Batteries” on page 43.

Disposing of Batteries

Batteries must be properly discarded in compliance with local regulations (see “Important Information — Please Read Before Use” on page 11).

8.2 Probe Care and Diagnostics

BondMaster 600 probes are reliable and durable as long as they are carefully handled:

- Do not drop the probes on hard surfaces.
- Do not hit the probes with any objects.
- Resonance probes should always be used with Teflon tape on the inspection surface. In addition to prolonging the life of the probe, this measure also makes the probe easier to use.
- Pitch-catch probes should have their active and stabilizing probe tips inspected and replaced very frequently; especially probes with removable active probe tips.

Appendix A: Specifications

This appendix contains the BondMaster 600 specifications.

A.1 General and Environmental Specifications

Table 6 on page 217 provides the general and environmental specifications.

Table 6 General and environmental specifications

Category	Parameter	Value
Housing	Overall dimensions (width × height × depth)	236 mm × 167 mm × 70 mm (9.3 in. × 6.57 in. × 2.76 in.)
	Weight	1.70 kg (3.75 lb), including lithium-ion battery
	Other	Factory-installed hand strap and back instruction label

Table 6 General and environmental specifications (continued)

Category	Parameter	Value
Environmental conditions	Operating temperature	-10 °C to 50 °C (50 °F to 122 °F)
	Storage temperature	With batteries: 0°C to 50 °C (32 °F to 122 °F) Without batteries: -20 °C to 70 °C (-4 °F to 158 °F)
	IP rating	Designed to meet requirements of IP66
	Drop tested	Method 516.6 Procedure IV, 26 drops, package for shipment (Handheld & Portable products)
	Shock tested	Method 516.6 Procedure I, a) Handheld & Portable products, 6 cycles each axis, 15 g, 11 ms half-sine, or b) In line / Rack Mount / Desk Top products, 40 G's on 3 faces × 1 time each face.
	Vibration tested	Method 514.6 Procedure I, Annex C, Figure 514.6C-5, general exposure: 1 hour each axis
	Explosive environment	Safe operation as defined by Class I, Division 2, Group D, as found in the National Fire Protection Association Code [NFPA 70], Article 500, and tested using MIL-STD-810F, Method 511.5, Procedure I.
Batteries	Battery model	600-BAT-L-2 (Li-ion) [U8760058]
	Battery type	Single lithium-ion rechargeable battery or AA-size alkaline batteries (in 8-cell holder)
	Battery storage temperature	0 °C to 50 °C (32 °F to 122 °F) at 80 % relative humidity
	Battery charge time	4 hours using the internal charger or an optional battery charger
	Battery life	Between 8 hours and 9 hours
	Battery size (width × height × length)	Approximately 58.9 mm × 22.3 mm × 214.6 mm (2.4 in. × 0.9 in. × 8.5 in.)
External DC supply	DC-IN voltage	24 VDC (60 W)
	DC connector	Circular, 2.5 mm pin diameter, center-positive
	DC supply, external (suggested model)	EP-MCA-X, where "X" denotes the power cord type (see Table 16 on page 230)

Table 6 General and environmental specifications (continued)

Category	Parameter	Value
Display	Size (width × height, diagonal)	117.4 mm × 88.7 mm, 146.3 mm (4.62 in. × 3.49 in., 5.76 in.)
	Resolution	640 × 480 pixels (full VGA)
	Number of colors	256
	Type	Full VGA (640 × 480 pixels) color transfective LCD (liquid crystal display)
	Viewing angles	Horizontal: -80° to 80° Vertical: -80° to 80°
	Screen modes	Normal or full screen
	Grid and display tools	Choice of 5 grids (OFF, 10 × 10, FINE, COARSE, and WEB) and user-selected crosshairs available on XY displays
	Modes (all possible)	Available display modes depend on the BondMaster 600 model and selected operating mode. Choice of RF view (time-based waveform featuring raw waveform named RF, or signal amplitude envelope named IMPULSE), single impedance plane (also named XY flying dot), split screen (RF and XY), strip chart (named SCAN, representing amplitude and phase against time), split screen (XY + SCAN), SPECTRUM (amplitude and phase against frequency) and split screen (XY + SPECTRUM).
Other	Standards or directives	MIL Standard 810G, CE, WEEE, FCC (USA), IC (Canada), RoHS (China), RCM (Australia and New Zealand), KCC (Korea)
	Power requirements	AC mains: 100 VAC to 120 VAC, or 200 VAC to 240 VAC, 50 Hz to 60 Hz
	Warranty	One year limited; extra warranty year available for purchase (W2-BONDMASTER600 [U8775337])

A.2 Input/Output Specifications

Table 7 on page 220 provides the specifications for the input and output signals.

Table 7 Input/output specifications

Parameter	Value
USB	One USB 2.0 peripheral port
Video output	One standard VGA analog output port
Input/output	One 15-pin I/O port (male) with 6 analog outputs, 4 alarm outputs (which can become inputs), and 2 encoder signals (future expansion)

Table 8 on page 220 describes all the connections available on the 15-pin I/O connector. Table 9 on page 220 describes all the connections available on the VGA OUT 15-pin connector.

Table 8 BondMaster 600 Input/Output 15-pin I/O connector

Pin	Signal	Description
1	AOUT_1	Analog Output 1
2	AOUT_2	Analog Output 2
3	AOUT_3	N/A
4	AOUT_4	N/A
5	AOUT_5	N/A
6	AOUT_6	N/A
7	GND	Ground
8	VDD	+5 V voltage
9	ENCD_INT	Encoder Interrupt (future expansion)
10	ENCD_DIR	Encoder Direction (future expansion)
11	GND	Ground
12	HW_IO_1	Hardware I/O 1: Alarm Output 1, Generic Input 1
13	HW_IO_2	Hardware I/O 2: Alarm Output 2, Generic Input 2
14	HW_IO_3	Hardware I/O 3: Alarm Output 3, Generic Input 3
15	HW_IO_4	Hardware I/O 4: Alarm Output 4, Generic Input 4

Table 9 BondMaster 600 VGA 15-pin port output*

Pin	Signal	Description
1	VGA_RED	VGA red output

Table 9 BondMaster 600 VGA 15-pin port output^a (continued)

Pin	Signal	Description
2	VGA_GREEN	VGA green output
3	VGA_BLUE	VGA blue output
4	NC	Not connected
5	GND	Ground
6	GND	Ground
7	GND	Ground
8	GND	Ground
9	NC	Not connected
10	GND	Ground
11	NC	Not connected
12	NC	Not connected
13	LCD_HSYNC	Horizontal sync.
14	LCD_VSYNC	Vertical sync.
15	NC	Not connected

a. Standard VGA output configuration

A.3 Bond Testing Specifications

Table 10 on page 221 provides the bond testing specifications.

Table 10 Bond testing specifications

Category	Parameter	Value
Bond testing connections	Probe connectors	11-pin Fischer
	Number of probe inputs	1

Table 10 Bond testing specifications (continued)

Category	Parameter	Value
Bond testing characteristics	Types	Pitch-catch (PC), mechanical impedance analysis (MIA), and resonance probes. The BondMaster 600 is fully compatible with BondMaster PowerLink and non-PowerLink probes, as well as other main probe and accessory suppliers.
	Gain	0 dB to 100 dB, in 0.1 dB or 1 dB increments. Certain test modes have limitations within this range.
	Rotation	0° to 359.9° in 0.1° or 1° increments
	Scan	Variable from 0.520 s to 40 s. Certain screen configurations have limitations within this range.
	Low-pass filter	6 Hz to 300 Hz. Certain test modes have limitations within this range.
	Probe drive	LOW, MEDIUM, and HIGH user-adjustable settings.
	Variable persistence	0.1 s to 10 s
	Variable display erase	0.1 s to 60 s

A.4 Pitch-Catch Tone Burst and Swept Mode Specifications

Table 11 on page 223 provides the pitch-catch tone burst and swept mode specifications.

Table 11 Pitch-catch tone burst and swept mode specifications

Category	Parameter	Value
Pitch-catch tone burst	Display modes (RUN key)	Choice of RF view (time-based waveform featuring raw waveform named RF, or signal amplitude envelope named IMPULSE), single impedance plane (also named XY flying dot), split screen (RF and XY), strip chart (named SCAN, representing amplitude and phase against time), split screen (XY + SCAN)
	Frequency range	1 kHz to 50 kHz
	Gain	RF waveform gain (raw signal): 0 dB to 70 dB, adjustable in 0.1 dB or 1 dB increments. An additional 0 dB to 60 dB is available for the XY flying dot display.
	Width	360 μ s to 10 ms, adjustable in 50 μ s increments
	Gate	10 μ s to 7920 μ s, adjustable in 10 μ s steps. New AUTO gate mode that auto-detects the peak amplitude from RF signal.
	Cycles	1 to 10, adjustable in 1 cycle increments
	Repetition rate	5 to 500 repetitions per second, adjustable in 5 rep/s increments
	Dot recordings	Up to 25 user-defined dot recordings

Table 11 Pitch-catch tone burst and swept mode specifications (continued)

Category	Parameter	Value
Pitch-catch swept	Display modes (RUN key)	Choice of single impedance plane (also named XY flying dot), SPECTRUM (amplitude and phase against frequency) and split screen (XY + SPECTRUM)
	Frequency range	5 kHz to 100 kHz
	Gain	0 dB to 60 dB, adjustable in 0.1 dB increments
	Sweep rate	LOW, MEDIUM, and HIGH user-adjustable rate controlling the repeat rate
	Frequency tracking	Up to 2 user-adjustable markers to monitor 2 specific frequencies from the swept figure

A.5 Mechanical Impedance Analysis and Resonance Mode Specifications

Table 12 on page 225 provides the mechanical impedance analysis (MIA) and resonance mode specifications.

Table 12 Mechanical impedance analysis and resonance mode specifications

Category	Parameter	Value
Mechanical impedance analysis	Display modes (RUN key)	Choice of single impedance plane (also named XY flying dot), strip chart (named SCAN, representing amplitude and phase against time), split screen (XY + SCAN)
	Calibration wizard	Calibration menu to determine best frequency for application, based on simple "BAD PART" and "GOOD PART" measurements
	Frequency range	2 kHz to 50 kHz
	Gain	0 dB to 100 dB, adjustable in 0.1 dB increments
	Low-pass filter	6 Hz to 500 Hz
	Dot recordings	Up to 25 user-defined dot recordings
Resonance	Display modes (RUN key)	Choice of single impedance plane (also named XY flying dot), strip chart (named SCAN, representing amplitude and phase against time), split screen (XY + SCAN)
	Calibration wizard	Calibration menu to determine best frequency based on the probe response
	Frequency range	1 kHz to 500 kHz
	Gain	0 dB to 60 dB, adjustable in 0.1 dB increments
	Low-pass filter	10 Hz to 500 Hz
	Dot recordings	Up to 25 user-defined dot recordings

A.6 Alarms, Connectivity, and Memory Specifications

Table 13 on page 226 provides the alarms, connectivity, and memory specifications.

Table 13 Alarms, connectivity, and memory specifications

Category	Parameter	Value
Alarms	Quantity	3 simultaneous alarms
	Available alarm types	Available alarm types depend on the BondMaster 600 model and selected operating mode. Choice of RF alarm (time series), BOX (rectangle), POLAR (circle), SECTOR (pie), SCAN (time-based), and SPEC (spectrum) featuring selection of AMPLITUDE or PHASE.
Connectivity and memory	PC software	BondMaster PC software, included in base BondMaster 600 kit. BondMaster PC enables viewing saved files and printing reports.
	On-board preview	Yes, selectable with knob
	Data storage	500 files
	Reference signal	Instant or recalled from memory

A.7 Interface Specifications

Table 14 on page 226 provides the interface specifications.

Table 14 Interface specifications

Category	Parameter	Value
Interface presentation	Languages	English, Spanish, French, German, Italian, Japanese, Chinese, Russian, Portuguese, Polish, Dutch, Czech, Hungarian, Swedish, and Norwegian
	Colors	8 schemes to accommodate all lighting conditions and user preferences

Table 14 Interface specifications (continued)

Category	Parameter	Value
Interface details	Instrument modes	Pitch-catch tone burst (RF or impulse displays), pitch-catch swept, mechanical impedance analysis (MIA), and resonance
	Menu structure	Single menu level interface with All Settings screens for easy configuration within a procedure
	Applications	Application selection menu for easy and rapid configuration
	Real-time readings	Available readings depend on the BondMaster 600 model and selected operating mode. Choice of up to 2 real-time readings measuring signal characteristics (selection of 4 amplitude measurements and 1 angle measurement)

Appendix B: Accessories, Replacement Parts, and Upgrades

Table 15 on page 229 through Table 18 on page 230 contain part numbers for BondMaster 600 accessories, support items, replacement parts, power cords, upgrades, warranty, and getting started guides.

Table 15 Optional accessories, support items, and replacement parts

Description	Part number
Chest harness (4-point connection)	EP4/CH [U8140055]
600 Series instrument stand assembly (replacement part)	600-STAND [U8780296]
External alarm booster adaptor	N600-EXTALM [U8780332]
600 Series VGA cable 1.52 m (5 ft)	600-C-VGA-5 [U8780298]
Communication cable HD15, female, single ended, 1.83 m (6 ft)	DSUB-HD15-6 [U8780333]
600 Series products display protectors (pack of 10)	600-DP [U8780297]
600 Series soft instrument and accessory case (knob version)	600-SC-K [U8780334]
External battery charger (user must choose power cord)	EPXT-EC-X, where "X" denotes the power cord type (see Table 16 on page 230)
Shoulder strap	3319871 [U8906253]

Table 16 Power cords for EP-MCA-X and EPXT-EC-X

Description of power-cord variable (X)	Item number
A = Australia	U8840005
B = Brazil	U8769007
C = China	U8769008
D = Denmark	U8840011
E = Europe	U8840003
I = Italy	U8840009
J = Japan power cord and PSE insertion sheet	U8908649
K = United Kingdom	U8840007
P = India, Pakistan, S. Africa, and Hong-Kong	U8840013
S = South Korea	U8769009
U = United States of America and Canada	U8840015

Table 17 Upgrade and warranty

Description	Part number
BondMaster 600 Extended Warranty (one additional year) including calibration (not available in all countries)	W2-BONDMASTER600 [U8775337]
B600 to B600M upgrade, including resonance probe cable	B600-UPG-M [U8670219]

Table 18 Getting Started Guides – all languages

Description	Part number
B600 Getting Started — Chinese	DMTA-10044-01ZH [U8670211]
B600 Getting Started — German	DMTA-10044-01DE [U8670212]
B600 Getting Started — English	DMTA-10044-01EN [U8030413]
B600 Getting Started — French	DMTA-10044-01FR [U8670213]
B600 Getting Started — Italian	DMTA-10044-01IT [U8670214]
B600 Getting Started — Japanese	DMTA-10044-01JA [U8670215]
B600 Getting Started — Russian	DMTA-10044-01RU [U8670216]

Table 18 Getting Started Guides – all languages (continued)

Description	Part number
B600 Getting Started — Spanish	DMTA-10044-01ES [U8670217]
B600 Getting Started — Portuguese	DMTA-10044-01PT [U8670218]

List of Figures

Figure i-1	BondMaster 600	25
Figure 1-1	Transport case contents	29
Figure 2-1	The BondMaster 600 connections	33
Figure 2-2	The top end connectors	34
Figure 2-3	The connectors behind the I/O door	35
Figure 2-4	The I/O and VGA OUT connectors	36
Figure 2-5	Location of the BondMaster 600 power button and indicator light	37
Figure 2-6	The charger/adaptor indicator light on the front panel	37
Figure 2-7	Connecting the charger/adaptor	38
Figure 2-8	Connecting the DC power cable	39
Figure 2-9	The battery compartment	41
Figure 2-10	Removing the lithium-ion battery	43
Figure 2-11	The alkaline battery holder	44
Figure 2-12	Installing the microSD card	45
Figure 2-13	Overview of the BondMaster 600 — Front view	46
Figure 2-14	Overview of the BondMaster 600 — Back view	47
Figure 2-15	The BondMaster 600 front panel with SmartKnob and keypad.....	48
Figure 2-16	The BondMaster 600 English keypad	49
Figure 2-17	The BondMaster 600 international keypad	49
Figure 2-18	The BondMaster 600 Chinese keypad	50
Figure 2-19	The BondMaster 600 Japanese keypad	50
Figure 2-20	Location of the PROBE connector	53
Figure 2-21	The VGA OUT and I/O connectors	54
Figure 2-22	The microSD slot and USB port	56
Figure 2-23	BondMaster 600 stand	57
Figure 3-1	The BondMaster 600 label showing keypad functions	59
Figure 3-2	Application choices on the quick-setup menu	60
Figure 3-3	The PowerLink recognition screen	60
Figure 3-4	The main inspection screen	62
Figure 3-5	The BondMaster 600 front panel and main inspection screen	63

Figure 3-6	The ALL SETTINGS menu	64
Figure 3-7	Example of LIVE AMPL, LIVE VERT, LIVE HORZ, and LIVE ANGL	67
Figure 3-8	Example of VOLTS P-P	67
Figure 4-1	The SYSTEM SETUP screen	72
Figure 4-2	Crosshairs and the NULL point	76
Figure 5-1	PowerLink recognition screen	77
Figure 5-2	The BondMaster 600 controls.....	78
Figure 5-3	The RF DISPLAY	81
Figure 5-4	The PC (RF) main menu	82
Figure 5-5	The PC Swept display	86
Figure 5-6	The MIA Mode Display	89
Figure 5-7	The resonance display	91
Figure 5-8	The RUN setting	94
Figure 5-9	The stored dots	96
Figure 5-10	D ERASE fine (<i>left</i>) and coarse (<i>right</i>) functions	98
Figure 5-11	Alarm threshold control	102
Figure 5-12	Alarm DWELL control	103
Figure 5-13	Alarm HORN control	103
Figure 5-14	The PC Swept mode's alarm DWELL setting control	106
Figure 5-15	The PC Swept mode's alarm HORN setting control	106
Figure 5-16	The PC Swept mode's BOX alarm shape controls	108
Figure 5-17	The PC Swept mode's SECTOR alarm shape controls	109
Figure 5-18	The PC Swept mode's CIRCLE alarm shape controls	110
Figure 5-19	The MIA mode's alarm DWELL setting controls	112
Figure 5-20	The MIA mode's alarm HORN setting control	112
Figure 5-21	The RESON mode's alarm DWELL control	114
Figure 5-22	The RESON mode's alarm HORN control	114
Figure 5-23	The FILE MANAGER menu's memory text editor and special buttons	118
Figure 5-24	The APPL SELECT menu	120
Figure 5-25	The ALL SETTINGS menu (first of two screens)	121
Figure 5-26	The PASSWORD menu	122
Figure 5-27	The ABOUT menu	124
Figure 5-28	The REGULATORY SCREEN	125
Figure 5-29	The RESET menu	127
Figure 6-1	Materials — skin-to-core disbonds in flat or constant geometry	131
Figure 6-2	The Skin To Core Disbonds (Flat) application	132
Figure 6-3	The GAIN adjustment to obtain a contained signal	132
Figure 6-4	Detecting the far-side and near-side disbonds	133
Figure 6-5	The recommended GATE position	134
Figure 6-6	The IMPULSE display	135
Figure 6-7	The scan over the disbonds	136

Figure 6-8	Adjusting the disbond signal angle	136
Figure 6-9	Adjusting the H GAIN and V GAIN	137
Figure 6-10	The amplitude (A) and phase (°) of the XY flying dot	137
Figure 6-11	RUN 1 – RF signal	138
Figure 6-12	RUN 2 – RF + XY (default view)	138
Figure 6-13	RUN 3 – XY FLY DOT	139
Figure 6-14	RUN 4 – XY + SCAN	139
Figure 6-15	RUN 5 – SCAN	140
Figure 6-16	The list of all parameters	141
Figure 6-17	Materials – skin-to-core disbonds in tapered geometry	142
Figure 6-18	The Skin To Core Disbonds (Tapered) application	143
Figure 6-19	The swept figure between two divisions	143
Figure 6-20	The full-screen display of the scan	144
Figure 6-21	The list of all parameters	145
Figure 6-22	Materials – smaller disbonds using MIA technique	146
Figure 6-23	The Smaller Disbonds and Repair Identification application	147
Figure 6-24	The scan signal of a disbond	147
Figure 6-25	The signal angle adjusted upwards	148
Figure 6-26	The signal amplitude adjusted to enter the alarm box	148
Figure 6-27	The second scan over the disbond	149
Figure 6-28	The list of all parameters	150
Figure 6-29	Materials – repaired areas (potting) using MIA technique	150
Figure 6-30	The Smaller Disbonds and Repair Identification application	151
Figure 6-31	Adjusting the dot position	152
Figure 6-32	The scan over the disbond and repaired area	153
Figure 6-33	Adjusting the signal angle upwards	153
Figure 6-34	Adjusting the signal amplitude	154
Figure 6-35	The second scan over the disbond and repaired area	154
Figure 6-36	The list of all parameters	155
Figure 6-37	Materials – metal-to-metal bonds using resonance technique	156
Figure 6-38	The Metal To Metal Disbonds application	157
Figure 6-39	The CAL screen	157
Figure 6-40	The first dot recorded	158
Figure 6-41	The second dot recorded	159
Figure 6-42	The GAIN adjusted to set the higher dot	159
Figure 6-43	The second scan over the disbonds	160
Figure 6-44	The list of all parameters	161
Figure 6-45	Materials – delamination in composites using resonance technique	162
Figure 6-46	The Delamination and Laminates Inspection application	163
Figure 6-47	The CAL screen	163
Figure 6-48	The first dot recorded	164
Figure 6-49	The second dot recorded	165

Figure 6-50	The third dot recorded	165
Figure 6-51	The GAIN adjusted to set the highest dot	166
Figure 6-52	The second scan over the disbonds	166
Figure 6-53	The alternate display of amplitude and phase	167
Figure 6-54	The list of all parameters	168
Figure 6-55	Materials – analyzing frequency response using PC Swept	169
Figure 6-56	The Skin To Core Disbonds (Tapered) application	170
Figure 6-57	The swept figure between two divisions	171
Figure 6-58	The background reference signal	172
Figure 6-59	The frequency spectrum view (right side of screen)	173
Figure 6-60	The frequency-tracking signal trace	174
Figure 6-61	Materials – finding the best frequency using the MIA technique	175
Figure 6-62	The Smaller Disbonds and Repair Identification application	176
Figure 6-63	The signal for the smaller defect	177
Figure 6-64	The signal for the defect-free zone	177
Figure 6-65	Selecting the best operating frequency	178
Figure 6-66	Adjusting the angle to move the dot upwards	179
Figure 6-67	The GAIN adjustment to the air signal dot	180
Figure 6-68	The second scan over the defect(s)	180
Figure 7-1	BondMaster PC Device menu	182
Figure 7-2	The Capture Screen dialog box	182
Figure 7-3	The ABOUT menu	183
Figure 7-4	The UPGRADE menu	184
Figure 7-5	The message indicating the battery charger is not connected	184
Figure 7-6	The message indicating the battery charger is connected	185
Figure 7-7	The Utilities menu	185
Figure 7-8	The Upgrade Device dialog box	186
Figure 7-9	Files in the left pane of the BondMaster PC window	187
Figure 7-10	The File menu	187
Figure 7-11	Selecting the Remote Command	188
Figure 7-12	The Device menu – Issue Command	188
Figure 7-13	The Issue Command dialog box	189
Figure 7-14	The Remote Command dialog box	203
Figure 7-15	Knob functions	204
Figure 7-16	The File Manager command	205
Figure 7-17	The Manage File dialog box	205
Figure 7-18	The Confirmation dialog box for file deletion	206
Figure 7-19	The Rename dialog box	207
Figure 7-20	Message asking you to confirm the recall	207
Figure 7-21	The Unlock Options command	208
Figure 7-22	The Unlock Options dialog box	209
Figure 7-23	The microSD card location	210

Figure 7-24	The Backup command	210
Figure 7-25	The Backup dialog box (start)	211
Figure 7-26	The Confirmation dialog box to confirm backup start	211
Figure 7-27	The Backup dialog box (complete)	211
Figure 7-28	The Restore command	212
Figure 7-29	The Restore dialog box (start)	212
Figure 7-30	The Confirmation dialog box to confirm the restore start	212
Figure 7-31	The Restore dialog box (complete)	213

List of Tables

Table 1	Charger/adaptor and battery indicators	40
Table 2	Keypad functions	51
Table 3	PC Swept mode XY ALM 1 & XY ALM 2 — SHAPE adjustments	107
Table 4	Reset types	127
Table 5	BondMaster 600 remote commands	190
Table 6	General and environmental specifications	217
Table 7	Input/output specifications	220
Table 8	BondMaster 600 Input/Output 15-pin I/O connector.....	220
Table 9	BondMaster 600 VGA 15-pin port output	220
Table 10	Bond testing specifications	221
Table 11	Pitch-catch tone burst and swept mode specifications	223
Table 12	Mechanical impedance analysis and resonance mode specifications	225
Table 13	Alarms, connectivity, and memory specifications	226
Table 14	Interface specifications	226
Table 15	Optional accessories, support items, and replacement parts	229
Table 16	Power cords for EP-MCA-X and EPXT-EC-X	230
Table 17	Upgrade and warranty	230
Table 18	Getting Started Guides — all languages	230

