

Magna-Mike 8600 Thickness Gage Getting Started Guide

Intended Use

The Magna-Mike 8600 is designed to perform nondestructive inspections of industrial and commercial materials. Do not use the Magna-Mike 8600 for any purpose other than its intended use.

Instruction Manual

Before use, thoroughly review the *Magna-Mike 8600 User's Manual* (P/N: DMTA-10026-01EN). Use the product as instructed. The User's Manual can be found on the documentation CD (P/N: 8600-MAN-CD [U8778535]) shipped with the instrument, and it contains essential information on how to use this Evident product safely and effectively. Keep the documentation CD in a safe, accessible location.

Safety Signal Words



DANGER

Indicates an imminently hazardous situation and calls attention to a procedure, practice, or the like, which, if not correctly performed or adhered to, will result in death or serious personal injury



WARNING

Indicates a potentially hazardous situation and calls attention to a procedure, practice, or the like, which, if not correctly performed or adhered to, could result in death or serious personal injury.



CAUTION

Indicates a potentially hazardous situation and calls attention to a procedure, practice, or the like, which, if not correctly performed or adhered to, may result in minor or moderate personal injury, material damage, particularly to the product, destruction of part or all of the product, or loss of data.

Package Contents

The Magna-Mike 8600 comes standard with several key accessories:

1. Magna-Mike 8600 thickness gage
2. AC charger/adaptor (P/N: EP-MCA-X), where X denotes power cord model.
3. Power cord
4. *Getting Started Guide* (P/N: DMTA-10028-01EN [U8778545])
5. *Magna-Mike 8600 User's Manual* on CD-ROM (P/N: 8600-MAN-CD [U8778535])
6. Instrument transport case (P/N: 600-TC [U8780294])
7. One standard probe (P/N: 86PR-1 [U8470020])
OR
One right-angle probe (P/N: 86PR-2 [U8470028])
OR
One low-profile probe (P/N: 86PR-3 [Q7800004])
One probe cable (P/N: 86PC [U8801410])
8. One standard calibration kit (P/N: 86ACC-KIT [U8771068])
OR
One extended range calibration kit (P/N: 86ACC-ER-KIT [U8771069])
OR
One low-profile probe calibration kit (P/N: 86ACC-PR3-KIT [Q7800005])
9. Interface program (P/N: WINXL [U8774010])
10. One RS-232 cable (P/N: 600-C-RS232-5 [U8780299])
OR
One USB cable (P/N: EPLTC-C-USB-A-6 [U8840031])

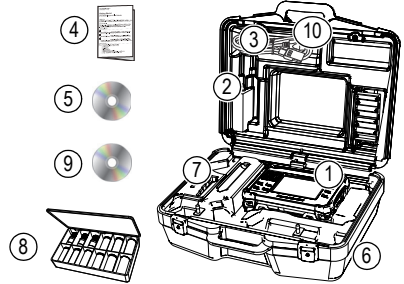

Connections

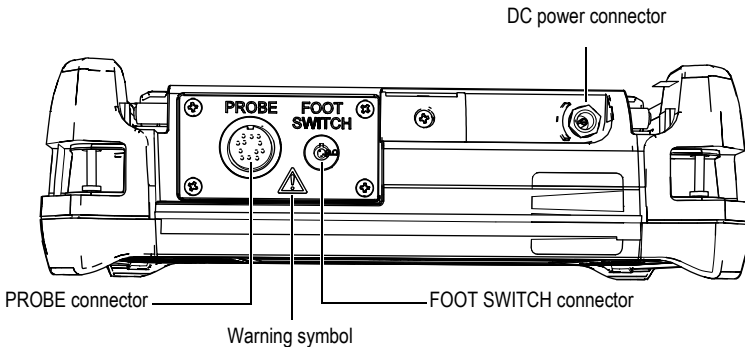

CAUTION

To avoid the risk of an electric shock, do not touch the inner conductors of the PROBE and/or FOOT SWITCH connector.

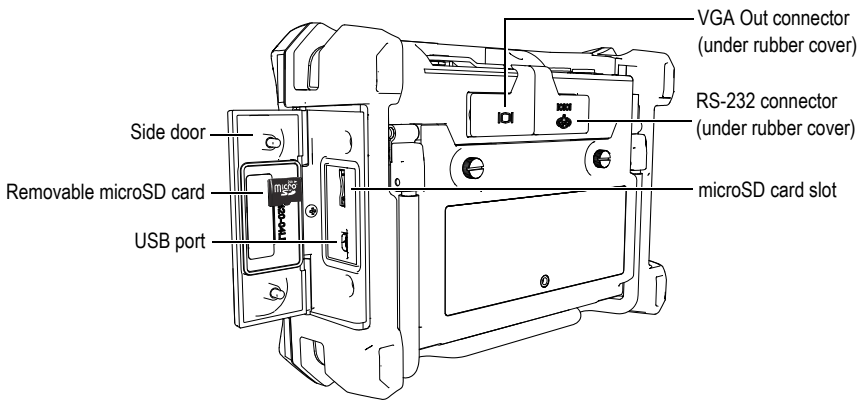

Charging the Optional Lithium-Ion Battery

The Magna-Mike 8600 charges the optional internal lithium-ion battery while it is connected to the AC charger/adaptor.



CAUTION

If the Magna-Mike 8600 is to be used with the optional rechargeable battery, only use Evident battery P/N: 600-BAT-L-3 [U8051431] to avoid the risk of injury or equipment damage. Do not use this battery with other products.



WARNING

The Magna-Mike 8600 charger/adaptor (P/N: EP-MCA-X) is designed to power the Magna-Mike 8600 and charge the optional lithium-ion battery only (P/N: 600-BAT-L-3 ([U8051431])). Do not attempt to charge any other batteries, including alkaline batteries using the battery tray (P/N: 600-BAT-AA [U8780295]), or use any other charger/adaptor. Doing so might cause an explosion or injury.

Do not attempt to power or charge other electronic equipment with the charger/adaptor (P/N: EP-MCA-X) as this could cause death or serious personal injury as the result of an explosion.

IMPORTANT

The optional lithium-ion battery is not fully charged when the instrument is shipped. You must charge the battery for two to three hours before using the battery power to operate the instrument.



WARNING

- The Magna-Mike 8600 probes contain strong magnets and the instrument can be used with strong magnetic target balls.
 - Do not bring a magnet near a person who has a pacemaker or electrical medical device, or near any other electrical medical devices. It is extremely dangerous and can cause the device to malfunction.
 - Never swallow or place a magnet in body orifices, including but not limited to ears, nose, or mouth. Magnets can cause serious injury, or even death, if swallowed. Seek immediate medical attention if magnets enter the body.
-

- Do not place a magnet within the reach of children or mentally impaired adults.
 - Do not burn rare earth magnets as toxic fumes can result.
-

To Replace the Optional Lithium-Ion Battery

1. Unfold the instrument pipe stand.
2. Unscrew the two thumb screws securing the battery compartment cover at the back of the instrument.
3. Remove the battery compartment cover.
4. Disconnect and remove the battery.
5. Install a new battery (P/N: 600-BAT-L-3 ([U8051431]) into the battery compartment, and then reinstall the battery compartment cover.

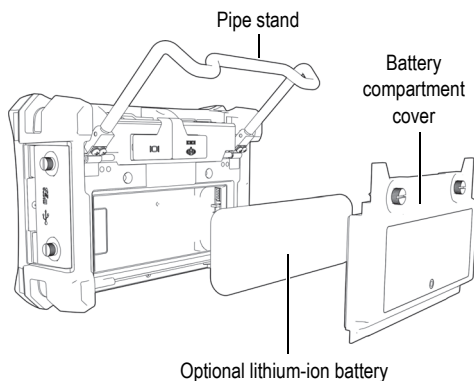

CAUTION

- Before disposing of a battery, check your local laws, rules, and regulations, and follow them accordingly.
 - When using the optional lithium-ion battery (Evident P/N: 600-BAT-L-3 [U8051431]) or AA-size lithium metal batteries in the optional alkaline battery tray (Evident P/N: 600-BAT-AA [U8780295]), the user must be aware that transportation of these batteries is regulated by the United Nations under the United Nations Recommendations on the Transport of Dangerous Goods. It is expected that governments, intergovernmental organizations, and other international organizations shall conform to the principles laid down in these regulations, thus contributing to worldwide harmonization in this field. These international organizations include the International Civil Aviation organization (ICAO), the International Air Transport Association (IATA), the International Maritime Organization (IMO), the US Department of Transportation (USDOT), Transport Canada (TC), and others. Please contact the transporter and confirm current regulations before transportation of lithium-ion or lithium metal batteries. Please note that Evident does not supply lithium metal batteries.
 - If the user chooses to use the Magna-Mike 8600 with a rechargeable battery, only use Evident P/N: 600-BAT-L-3 (U8051431). Do not use this battery with other products.
-

To Install the Optional microSD Card

1. Remove the microSD card (P/N: MICROSD-ADP-2GB [U8779307]) from its packaging.
2. Open the instrument side door.
3. Hold the card so that the microSD card label faces toward the rear of the instrument.
4. Gently slide the card into the microSD slot until it clicks.

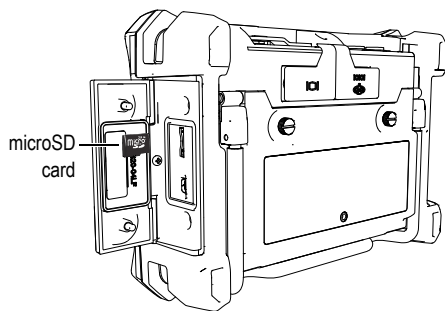

NOTE

To remove the microSD card, gently push the card into the instrument and release. A spring-loaded mechanism will partially eject the card, and then you can grasp and remove it from the instrument.

To Select a Target

- ◆ Choose the target ball, disk, or wire that best suits your application. The target must roll freely in the contours of the material being inspected.

IMPORTANT

Note that large targets have large thickness ranges but may compress soft materials. Small targets have smaller maximum thickness capability and fit into smaller contours.

Part number	Description	Application	Maximum thickness (with standard wear tip)	Maximum thickness (with chisel wear tip)	Maximum thickness (with low-profile probe 86PR-3)
80TB1 (U8771030)	1.59 mm (1/16 in.) target ball	Thin or compressible material with intricate geometry.	2.03 mm (0.080 in.)	2.03 mm (0.080 in.)	2.03 mm (0.080 in.)
80TB2 (U8771031)	3.18 mm (1/8 in.) target ball	General applications for plastic bottles.	6.10 mm (0.240 in.)	4.06 mm (0.160 in.)	4.06 mm (0.160 in.)
80TB3 (U8771032)	4.76 mm (3/16 in.) target ball	Thicker material where a 4.76 mm (3/16 in.) ball will roll freely.	9.14 mm (0.360 in.)	6.10 mm (0.240 in.)	Not available
80TB4 (U8771033)	6.35 mm (1/4 in.) target ball	Thicker non-compressible material where a 6.35 mm (1/4 in.) ball will move freely.	12.70 mm (0.500 in.)	9.14 mm (0.360 in.)	Not available

Part number	Description	Application	Maximum thickness (with standard wear tip)	Maximum thickness (with chisel wear tip)	Maximum thickness (with low-profile probe 86PR-3)
86TBM3 (U8771039)	Magnetic 4.76 mm (3/16 in.) target ball	Thicker material where a smaller target ball is needed due to contours.	19.05 mm (0.750 in.)	19.05 mm (0.750 in.)	Not available
86TBM4 (U8771040)	Magnetic 6.35 mm (1/4 in.) target ball	Non-compressible material where maximum thickness capability is needed.	25.40 mm (1.00 in.)	25.40 mm (1.00 in.)	Not available
80TD1 (U8771034)	Flat disk 12.70 mm (1/2 in.)	Thin channels where a standard target ball will not roll freely.	9.14 mm (0.360 in.)	9.14 mm (0.360 in.)	Not available
80TD2 (U8771035)	Knife edge (V) disk 6.35 mm (1/4 in.)	Small channels where the 80TD1 disk will not roll freely.	6.10 mm (0.240 in.)	6.10 mm (0.240 in.)	Not available
86TW1 (U8771041)	Wire target 1.14 mm (0.045 in.)	Wall thicknesses in holes or small diameter openings.	12.70 mm (0.500 in.)	12.70 mm (0.500 in.)	Not available
86TW2 (U8779858)	Wire target 0.66 mm (0.026 in.)	Wall thicknesses in holes or small diameter openings.	6.10 mm (0.240 in.)	6.10 mm (0.240 in.)	4.06 mm (0.160 in.)

To Calibrate the Magna-Mike 8600





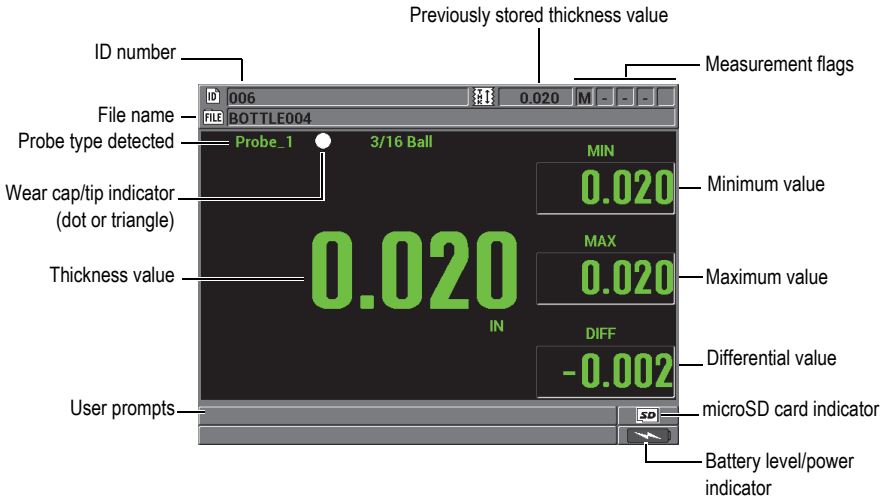



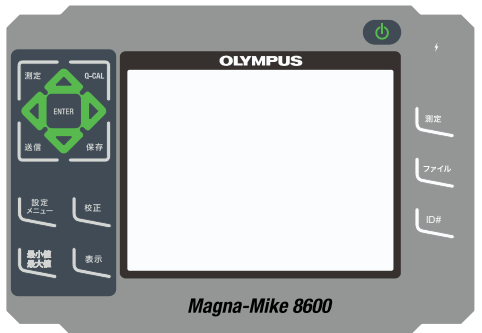
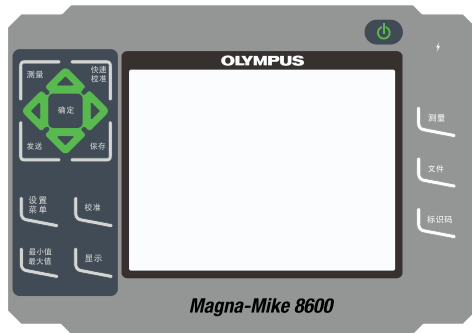
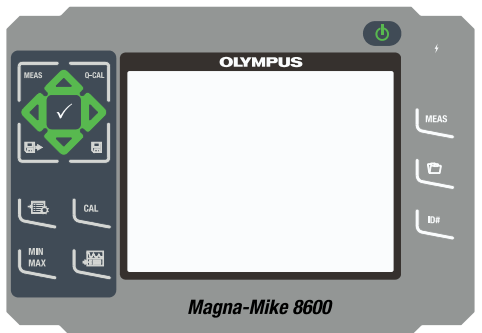
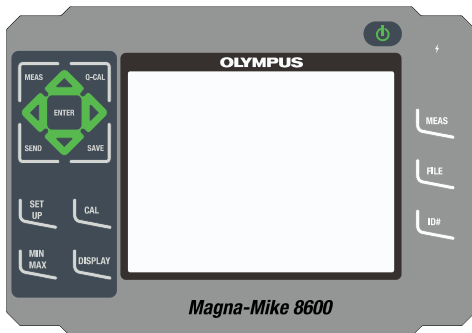



































- Press **[CAL]** to start the calibration process, and then follow the instructions on the screen.
 - BALL OFF:** The target is not in contact or close to the probe.
 - BALL ON:** Place the target on the probe tip using the appropriate ball, disk, or wire on the alignment fixture.
 - THIN SHIM:** Place the target and the calibration shim on the probe that corresponds to the thickness prompted by the instrument.
 - THICK SHIM:** Place the target and the calibration shim on the probe that corresponds to the thickness prompted by the instrument.
 - For better accuracy, add additional multi-points within the target measurement range.
- Press **[MEAS]** to complete the calibration process.

























Measurement Screen



Keypad



English	International	Chinese	Japanese	Function
				Completes the current operation and returns to the measurement screen.
				Compensates for drifts caused by moderate changes in temperature or ambient magnetic fields.
				Sends the active measurement out via the RS-232 or USB connection to an external device.
				Stores a measurement in the datalogger at the current ID number.
				Selects an highlighted item or accepts an entered value.
				<ul style="list-style-type: none"> – In a screen or a list, moves to the previous element. – For some parameters, a numerical entry increases the value.
				<ul style="list-style-type: none"> – In a screen or a list, moves to the next element. – For some parameters, a numerical entry decreases the value.
				<ul style="list-style-type: none"> – Selects the previous available value for the selected parameter. – In text edit mode, moves the cursor one character position to the left.
				<ul style="list-style-type: none"> – Selects the next available value for the selected parameter. – In text edit mode, moves the cursor one character position to the right.
				Provides access to the instrument parameters.
				Initiates the instrument calibration functions.

English	Inter-national	Chinese	Japanese	Function
				Opens the Min/Max setup menu.
				Opens the display control menu.
				Completes the current operation and returns to the measurement screen.
				Provides access to the file menu.
				Accesses several functions related to the ID numbers for the thickness measurement location.
				Turns the instrument power on or off.

Equipment Disposal

Before disposing of the Magna-Mike 8600, check your local laws, rules, and regulations, and follow them accordingly.

Electrical Warnings



CAUTION

To avoid the risk of electric shock, do not touch the inner conductors of the PROBE and FOOT SWITCH connectors. The warning symbol indicated in the figure below warns of this electric shock risk.

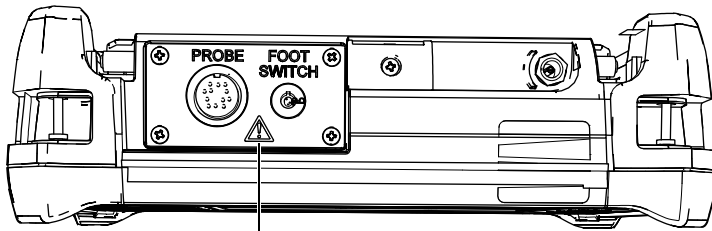

Warning symbol



WARNING

If the instrument is operated using a power cord, observe the following safety measures to avoid the risk of injury or equipment damage. (These safety measures are not applicable if the instrument is operated using only the battery.)

- Before turning on the instrument, you must connect the protective earth terminal of the charger/adaptor to the protective conductor (mains) of the power cord. The mains plug shall only be inserted into a socket outlet provided with a protective earth contact. Never negate the protective action by using an extension cord (power cable) without a protective conductor (grounding).
- If there is any possibility that the ground protection could be impaired, you must make the instrument inoperative and secure it against any unintended operation.
- Use only the AC power cord supplied with the Magna-Mike 8600. Do not use this power cord with other products.
- The instrument must only be connected to a power source corresponding to the type indicated on the rating label.

EVIDENT SCIENTIFIC INC., 48 Woerd Avenue, Waltham, MA 02453, USA
EvidentScientific.com

Printed in the United States of America • Copyright © 2022 by Evident. All rights reserved.

The microSD logo is a trademark of SD-3C, LLC.

All brands are trademarks or registered trademarks of their respective owners and third party entities.



Part ID: U8778545



DMTA-10028-01EN
Rev. C, September 2022



Printed on Rolland Hitech50,
which contains 50 % post-
consumer fiber.