

INDUSTRIAL

# A Microscope that Measures Up to Individual Needs

## STM7 Series Measuring Microscope



**EVIDENT**

# The Measuring Microscope Engineered to Fit Your Needs

Whether samples are small or large, simple or complex, or measurements are being taken by a novice or an expert, the STM7 series features measuring microscopes tailored to fit your needs.



STM7-LFA configuration

## INDEX

### > Wide Coverage

Compatible with a range of measurement and observation needs P.3

### > Operability

Simple, efficient operation P.5

### > Height Measurement

Accurately measure samples with irregular surfaces P.8

### > Advanced Measurement Software

Measure complex forms simply and accurately P.10

### > Suggested Models

STM7 configurations P.15

## STM7 Series

Measurement Software

**Stage Selection** (in mm)  
100 × 100, 200 × 200, 300 × 300

**Optics**  
Measuring Objectives/  
Metallurgical Objectives

**Frame**  
Manual Focus/  
Motorized Focus

**Focusing Equipment**  
Manual Focus Navigator Unit/  
Autofocus Unit

# Accurate Measurements

## Refined Optical Performance

The STM7 series uses the same UIS2 infinity-corrected optical system used in state-of-the-art optical microscopes. As a result, observed images have high resolution and high contrast, with aberration thoroughly eliminated to help ensure highly accurate measurement in minute detail.

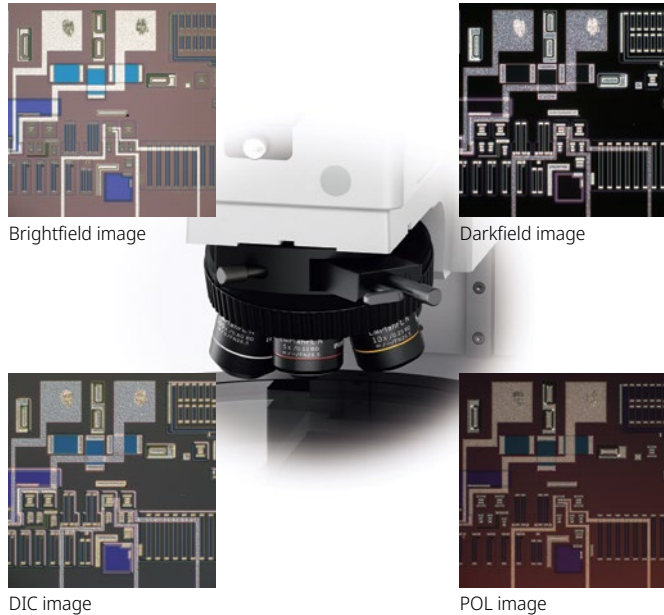

## High-Precision, 3-Axis Measurement

As modern manufacturing technology becomes increasingly miniaturized and precise, highly accurate measurements are even more essential—not only along the XY axes, but also along the Z-axis. We have responded to such needs by being the first to realize an autofocus system for measuring microscopes by means of the reflective active, confocal method.

## Reflective Active, Confocal Autofocus System Optical Path

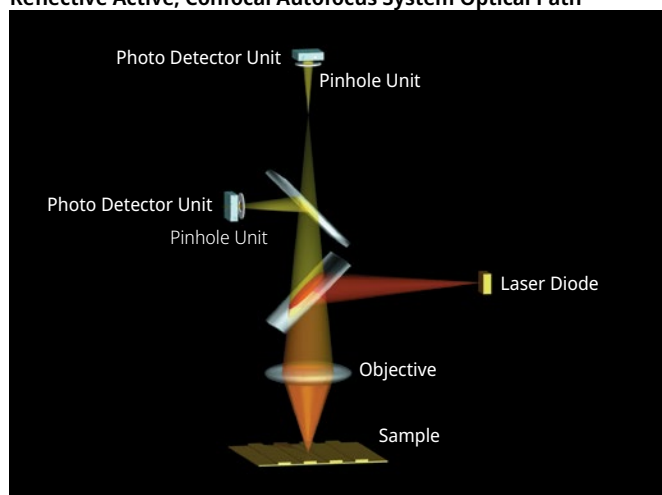

## Reliable Measurements with a Stone Stage-Mounting Plate

To provide further assurance of measurement accuracy, the STM7 series uses a highly durable, vibration-resistant frame with a granite surface plate. As a result of this stability, measurements can be taken at submicron levels while minimizing errors.

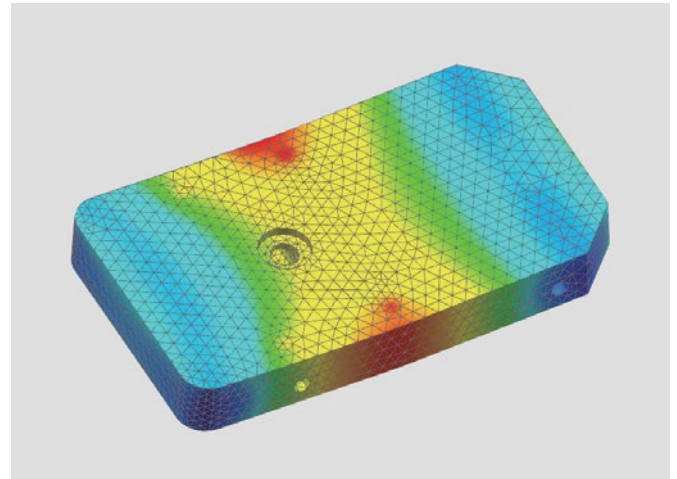

STM7-LF FEM analysis

## Dependable Quality Based On a Strict Traceability System\*

The accuracy of our measuring microscopes is controlled by a strict traceability system, and we even offer traceable calibration at the time of installation.

\* Traceability systems vary depending on periods and countries/regions. The samples used in STM7 calibrations are calibrated in each country/region. Please ask us for details.

# Wide Coverage: Stage

## Stages that Fit Your Samples



### Common Problems

Short measurement stroke precludes the measurement of larger samples.

Sample rotation required to compensate for shorter Y than X-axis coverage during measurement is time inefficient. Until now, large stages have offered a sufficient measurement coverage on the X-axis, but only less coverage on the Y-axis.

Due to the narrow measurement range, it is impossible to line up large numbers of samples on the stage for measurement at once.



### STM7 Solutions

The STM7 series features a 300 mm × 300 mm stage capable of measuring large samples, including 300 mm wafers and printed circuit boards.

X and Y-axis measurement areas are long and of equal length, eliminating the need to rotate samples.

Long measurement areas for both the X and Y-axis allow multiple samples to be lined up on the stage for more efficient measurement.

### Maximum Measurement Stroke 300 mm × 300 mm

Three types of stages are available, each with a unique square measurement stroke (choose from 100 mm × 100 mm, 200 mm × 200 mm, and 300 mm × 300 mm). From small to large size samples, there is a stage that fits the sample being measured.

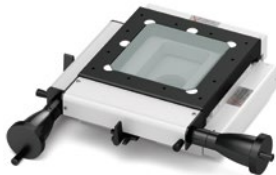

STM7-CS100  
100 mm × 100 mm

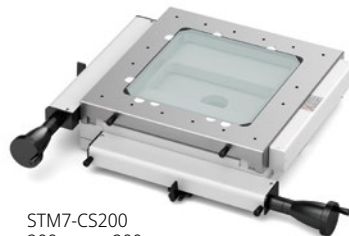

STM7-CS200  
200 mm × 200 mm

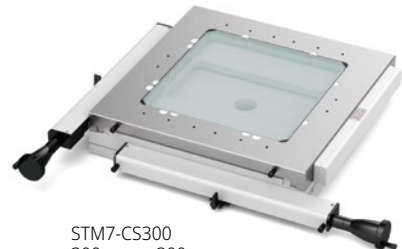

STM7-CS300  
300 mm × 300 mm

### Square Stroke Makes Measuring Large Samples Easier

The 300 mm square length stage enables the same measurement stroke to apply to both the X and Y-axes, which means it can be used to measure large samples, such as 300 mm wafers and printed circuit boards without changing their orientation.

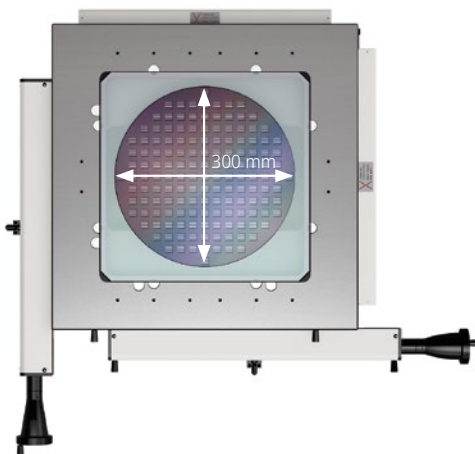

### Quickly Switch Between Coarse and Fine Movements

A clutch system enables rapid switching between coarse and fine movements. Thanks to this switching function, the stage can also be moved rapidly along the X- and Y-axes, and freely across the XY plane.

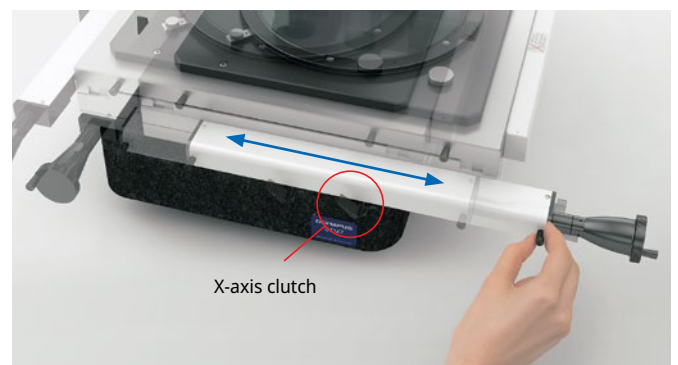

X-axis clutch



# Broad Range of Magnifications and Working Distances



## Common Problems

Most conventional measuring microscopes only accept a measuring objective or metallurgical objective, so they are unable to meet the requirements for a wide variety of observations.



## STM7 Solutions

The STM7 series meets the requirements of a wide variety of observations. It responds to your needs at both low and high magnifications, enables the measurement of uneven samples requiring ultra-long working distance objectives, and even offers a variety of observation methods.

### Low- and High-Magnification Observations

The STM7 series accepts both a metallurgical objective and a measuring objective by exchanging a revolving nosepiece with a measuring objective adapter. This means that the system combines both metallurgical optics and measuring optics in one microscope. In this way, the STM7 series satisfies a range of needs, whether measuring a wide area or tiny region, measuring the size of differences between levels, or assisting the user in deciding on the best observation method to choose.

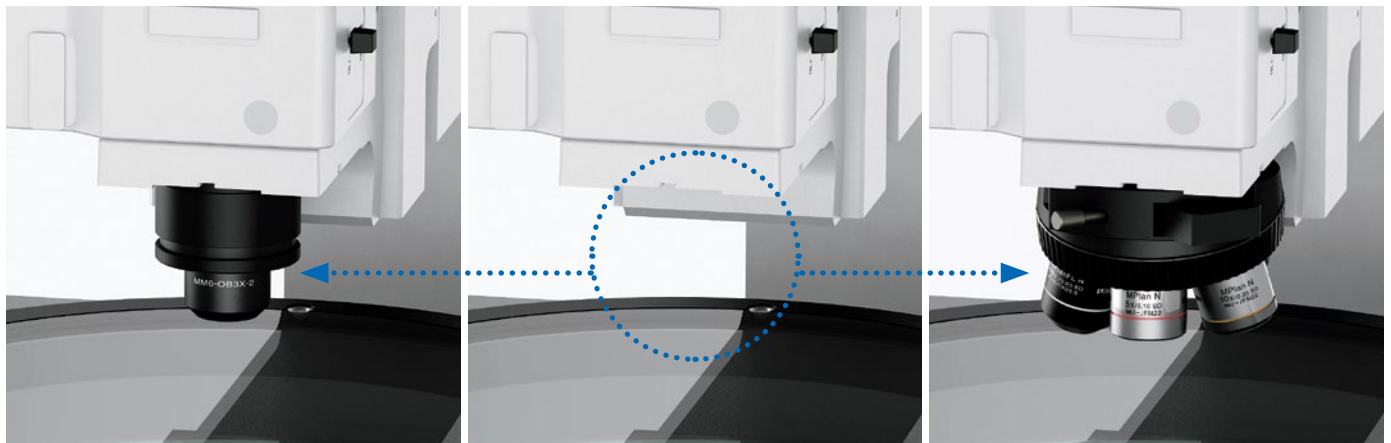

### Measuring Objectives

Because the measuring objectives have an extremely long working distance, they provide confidence when focusing on samples with large peaks and troughs while reducing the risk of the objective coming into contact with the sample. Furthermore, their low-magnification capability enables wide areas to be observed in a single view.

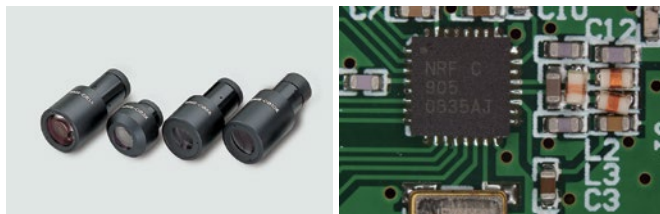

Brightfield image

### STM7-MMOBAD: Measuring Objective Mount Adapter

The STM7 measuring objective mount adapter enables a measuring objective to be used even in a metallurgical objective optical system.



### Metallurgical Objectives

Metallurgical objectives enable high-magnification, high-resolution observation comparable to that of optical microscopes. What's more, these objectives can be used for brightfield, darkfield, and DIC observation.

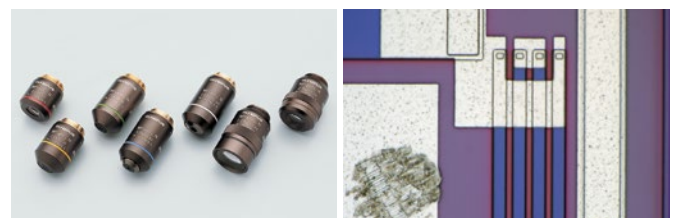

Brightfield image

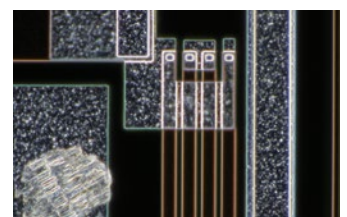

Darkfield image

# Operability: Measuring Microscope Operation

## A Revolutionary Control Unit Refines Usability



### Common Problems

Additional functions require additional operational units. Operators can't always locate the corresponding unit quickly, which significantly reduces measurement efficiency.

Numerous operational units and their power supplies around the main unit occupy valuable working space.



### STM7 Solutions

Almost all measuring microscope operations can be efficiently completed on the nearest operational unit.

The system requires only a single operational unit and power supply, regardless of how many functions are added, freeing up workspace.

### Controllers

With the STM7 series, a single controller makes it possible to perform virtually all measuring microscope operations, including use of readout reset, illumination control, focusing, and autofocus. For efficiency and convenience, the unit can be placed wherever you wish and operated easily with one hand.

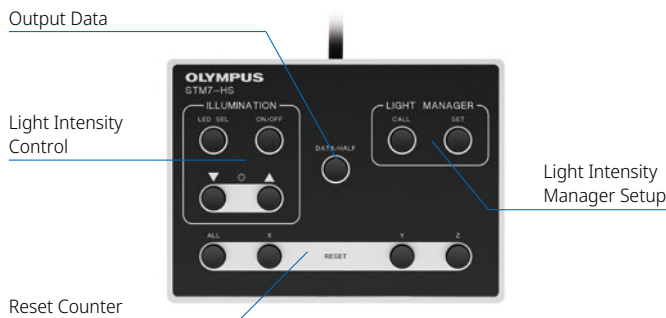

For Manual Z-axis Focusing Models:  
STM7-HS Hand Switch



For Motorized Z-axis Focusing Models:  
STM7-MCZ Focus Controller

### Control Box

The power supply and transmission for each unit are combined in a single control box. This preserves maximal workspace even when a range of optional functions, such as the focus navigator, are added.

### Manual and Motorized Focusing Model Lineup

Focus control is available with either manual or motorized operation. Choose the model that addresses your needs in terms of samples and measurement content, regardless of stage size—with all frames incorporating a linear scale for the Z-axis that enables 3-axis measurement.



### Manual Z-Axis Focus Models

Manual Z-axis focus models offer excellent cost performance—with familiar handle operation for rapid vertical movement that offers convenience for users who need to measure samples with variety of heights.



### Motorized Z-Axis Focus Models

Operability is improved and handling fatigue is reduced for focus and height measurements when using the motorized focus unit. The coaxial knobs for coarse and fine movement offer a feeling similar to manual operation, while the models can also be equipped with an autofocus unit.

# Automatic Light Intensity Adjustment Improves Observation and Measurement Efficiency



## Common Problems

Analog volume adjustment used by conventional measuring microscopes does not enable the quantitative assessment of light intensity, which can lead to variability in measured values as light intensity changes.

With conventional measuring microscopes, light intensity may need to be adjusted every time the objective is switched—making for an inefficient workflow.



## STM7 Solutions

Observations and measurements can always be performed under the same conditions thanks to the STM7 series' quantitative display of light intensity value.

Illumination method and light intensity are automatically adjusted to the preset value when the objective is switched, whenever the light intensity manager is used in combination with a coded revolving nosepiece.

## Precisely Control Light Intensity Values with a Quantitative Digital Display

The STM7 series provides a quantitative digital display of light intensity—enabling observations to always be made under consistent illumination conditions.



Digital display shows quantitative light intensity

## No More Manual Adjustments

The light intensity manager can be used with the coded revolving nosepiece configuration. The coded revolving nosepiece automatically detects the switching of objectives. This allows the illumination method and light intensity to be registered for each objective and adjusted automatically during measurements when the objective is switched. Now there is no need to manually adjust light intensity, which used to be required with every switch between magnifications.

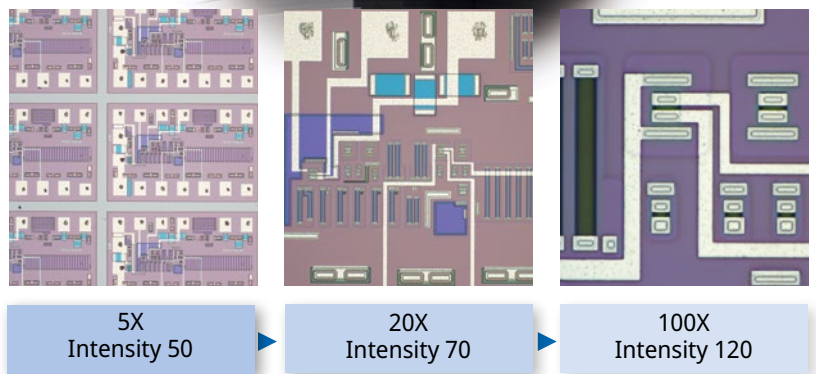

## Operability: Digital Read Out

# Check Measurement Results and Equipment Status Fast with a Detachable Digital Readout



### Common Problems

The need to check the operation status of equipment, such as illumination, or measured values on individual units makes overall operation cumbersome.



### STM7 Solutions

The STM7 series displays microscope status, such as illumination, together with measured values on an indicator display area, for easy checking at a glance.

### Fast, Visual Status Check

The indicator displays the device status and settings. The minimum X, Y, and Z-axis values can be switched between 0.1  $\mu\text{m}$  and 1  $\mu\text{m}$ , and the display units can be switched between mm,  $\mu\text{m}$ , inches and mil.

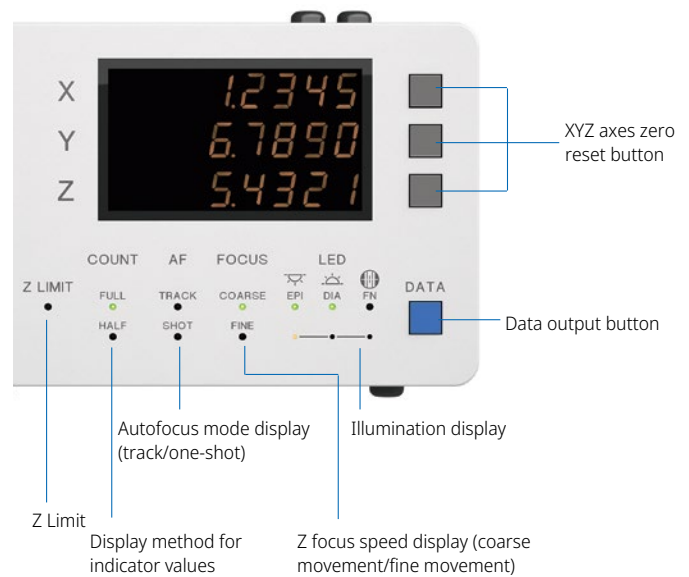

### Detachable Digital Readout Enables Individual Preference and Placement

Whether attached to the frame or a desk, the placement of the detachable digital readout is up to the individual user. While standing to take measurements, it can be placed on the side of the frame at almost the same height as the site of observation for an exceptional and easy view. When operating from a sitting position, such as observation or measurements on a monitor via a digital camera or when using the motorized Z-axis focusing model, simply place the digital readout and hand controller on the desk.



Digital readout attached to the frame



Digital readout placed on a desk



# Height Measurement: Focus Navigation System

## Faster, Simpler, More Accurate Height Measurement



### Common Problems

When doing visual measurement, variations can arise in the height measurements between different operators. Furthermore, this measurement method is time-consuming and inefficient.



### STM7 Solutions

The STM7 focus navigation system reduces the operator subjectivity in height measurements. It also shortens the time required to perform height measurement to achieve greater efficiency.

### Simple, Precise Focusing System with Superior Repeatability

Our focus navigator delivers highly reproducible height measurement by projecting a pattern within the field of view and identifying vertical deviations. Slight errors can occur in height measurements taken with normal visual observation, even when focus appears to be sharp. The focus navigator, however, enables measurements to be made simply by matching up the marks—thereby reducing operator subjectivity in measurement results.

#### Visual Height Measurement

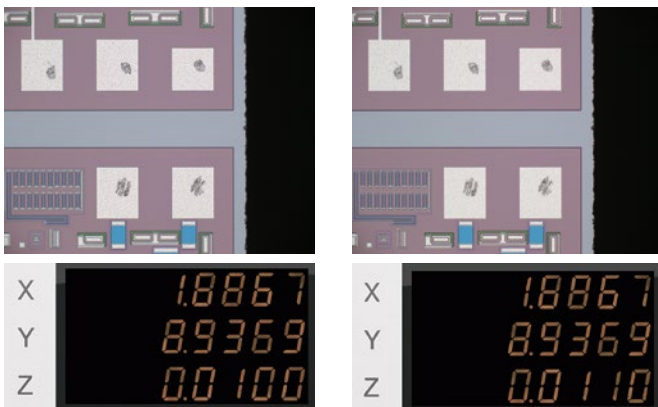

Operator subjectivity at the position at which measurements are taken can introduce differences in measurement results.

#### Focus Navigator

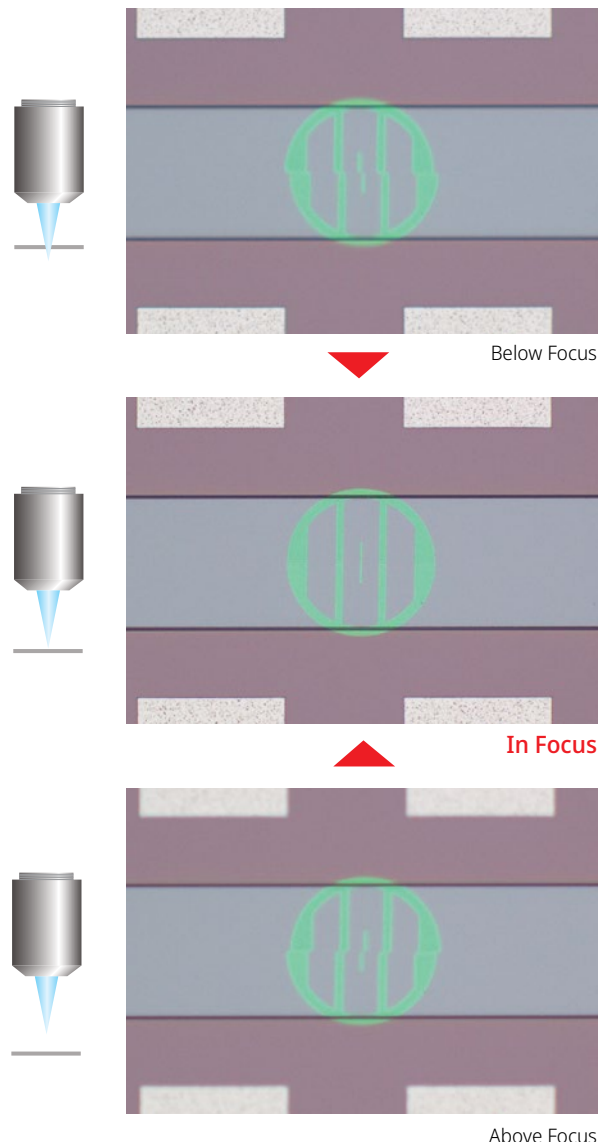

## Autofocus Advantages for Fast and Highly Accurate Height Measurement



### Common Problems

During visual measurement, the results of height measurement can vary between different operators.

Manual height measurement requires the operator to repeatedly move the stage and adjust the focus with the handle, making measurement time-consuming and inefficient.

Focusing on minute objects, such as bonding wires, is difficult.



### STM7 Solutions

With use of the autofocus unit, the measured value remains highly accurate regardless of the operator.

In TRACK mode, the image is automatically and continually kept in focus, enabling efficient height measurement in minimal time. The same mode renders manual focusing unnecessary for XY measurements, resulting in even more efficient operation.

When a 100X objective is used, the laser spot diameter can be as small as 1  $\mu\text{m}$ , permitting autofocus to be used locally, even on extremely minute objects.

### Fast, Accurate, Unbiased Focusing and Measurement

We have developed a dedicated autofocus unit for the STM7 series that delivers excellent reproducibility and rapid focus. As a result, highly accurate height measurements can be made within a short amount of time, irrespective of the level of operator experience.



### One-Shot Mode

Instantaneously takes autofocus from a roughly focused state to sharp focus located at the center of the field of view.

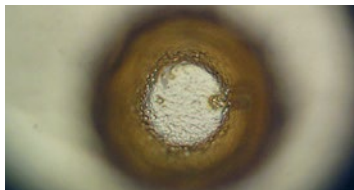

### TRACK Mode

The TRACK Mode provides autofocus that tracks the peaks and troughs of the sample, even if the stage is moved, keeping the image continually in focus. This advancement greatly improves the efficiency of Z-axis measurements by enabling observations to be made without taking your hands off the X and Y handles.

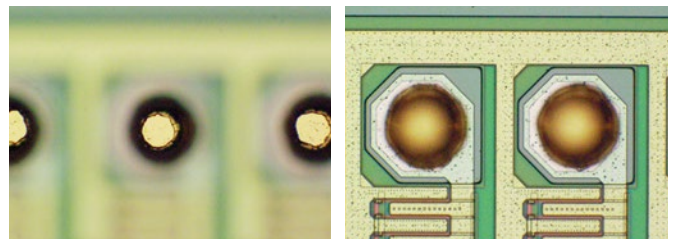

### Dedicated Autofocus Unit: Outstanding Reproducibility and Focusing Speed

The STM7 autofocus unit allows highly accurate height measurements to be made with minimal time, regardless of the level of operator experience. Use of the reflective active, confocal method provides a stable focal point independent of surface roughness or a slanting sample surface, while the small laser diameter enables the use of autofocus, even on minute objects, such as bonding wires.

# Measure Complex-Shaped Objects Accurately, Quickly, and Simply

The ability to clearly and easily see the output display component of measuring microscopes is essential. That is why we created measurement support software to help deliver complex measurements with greater accuracy. The software also enables the use of digital cameras.

## Software User Interface

The screenshot shows the OLYMPUS STM7-BSW software interface. A central live image display shows a circular object with a green fill and a black outline. A red crosshair is overlaid on the object. To the right, a 'Digital Indicator' panel shows X, Y, and Z coordinates. Below it, a 'Measurement items' panel contains icons for various measurement types. At the bottom right, a 'List' panel shows a table of measurement results. Callout boxes identify key UI elements: 'Live Image Display', 'Edge Tool Bar', 'Graphic', 'Measurement Menu', 'Measurement Results', and 'List'.

**Live Image Display**

**Edge Tool Bar**

**Graphic**  
Shows measured points, lines, circles, etc.

**Measurement Menu**

**Measurement Results**

**List**  
Shows measurement procedure

Number	Measurement	Items	Sample1	Sample2	Sample3	Sample4
001	Line(Angle)	Angle A	5.5757			
002	Line(Angle)	Angle A	95.4364			
003	Intersection ...	X coordinate	-1.4643			
003	Intersection ...	Y coordinate	0.1272			
003	Intersection ...	Z coordinate	0.0000			
003	Intersection ...	Intersection ...	89.8607			
003	Intersection ...	Intersection ...	90.1393			
004	Origin	X coordinate	-1.4643			



STM7 system with measurement support software

## Available Cameras

### High-performance model with high-speed

#### DP28

Image resolution 4104 × 2174  
 Frame rate 15 fps (max.)  
 PC interface USB 3.1 Gen1



#### DP23

Image resolution 3088 × 2076  
 Frame rate 25 fps (max.)  
 PC interface USB 3.1 Gen1



### Introductory model with high price-performance ratio

#### STM7-CU

Image resolution 2048 × 1536  
 Frame rate 11.2 fps (max.)  
 PC interface USB2.0



# Place the Sample and Start to Measure—No Parallel Alignment Required

## Direct Measurement

Measurements are made by receiving coordinates input via the STM7 system.

Direct measurement	Recall measurement
	Point
	Line (angle)
	Circle
	Rectangle
	Midpoint
	Distance between point and point
	Height between point and point
	Plane
	Ellipse

## Recall Measurement

Once measured and calculated, coordinates can be used again for subsequent measurements. This eliminates the need to carry out the same work twice, enabling a smoother and more efficient workflow.

Recall measurement	
	Intersection between line and line
	Center line
	Distance between point and line
	Height between point and plane
	Intersection between line and circle
	Intersection between circle and circle
	Contact point between point and circle

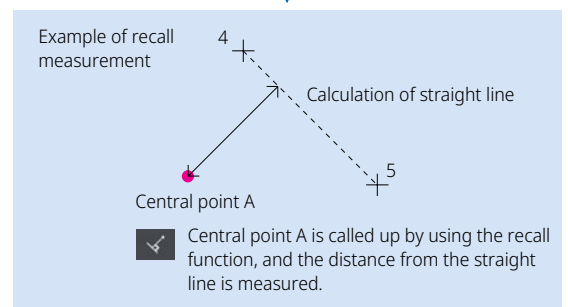
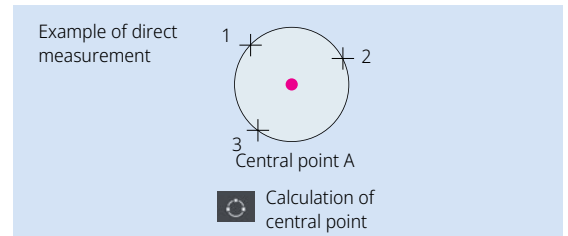

## Virtual Point Measurement

Intersections, central points, lengths, and a range of other measurements can be made by drawing straight lines and circles, which can then be set to remain as reference points on acquired sample images.

Virtual point	
	Virtual point
	Move point
	Rotate point
	Point of symmetry in the X axis
	Point of symmetry in the Y axis
	Point of symmetry in the origin

## Alignment Measurement

Both the origin and the X-axis are set with respect to the sample, allowing the sample to be measured even when it's not aligned with the stage.

Alignment	
	Origin
	X-axis
	Move origin
	Tilt

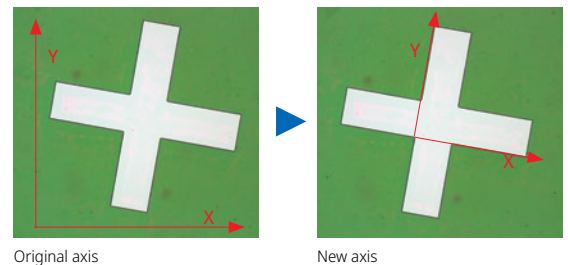

## XZ Plane Measurement

Conventional measuring microscopes measure the XY plane directly from above. However, in response to user demands, we have incorporated an XZ plane measurement function in our software to enable the measurement of cross-sections as seen from the side. Now, measurements that used to be difficult are much easier—such as radius measurements for vertical sections of hemispherical objects, or measurement of the depths of grooves with curved bases compared to a reference line.

XY measurement	
	Line (angle)
	Circle
	Distance between point and point
	Intersection between line and line
	Center line
	Distance between point and line
	Distance between line and circle (upper)
	Distance between line and circle (lower)

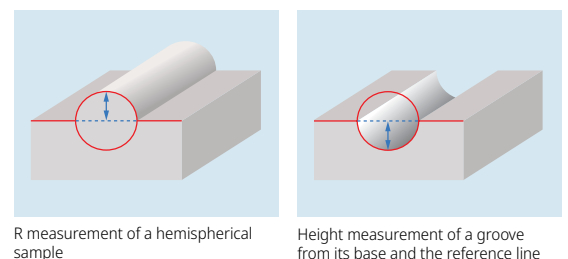



# Measurement Support Software

## Record Repeated Measurement Procedures

### Macro Registration

Frequently used alignment and other measurement procedures can be combined and assigned to a single macro button—eliminating the need to start from scratch each time the microscope is set up.

### Replay Measurement

Measurements can be easily repeated based on a recorded workflow by simply inputting the movement of the stage and the coordinates in response to a software prompt. This function can be used to repeatedly carry out the same measurement on the same sample, or different versions of the same sample. Furthermore, if a set value and tolerance are set in the recorded workflow, the software can automatically identify when a measurement has failed.

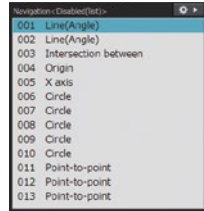

Number	Measurement	Items	Sample1	Sample2	Sample3	Stat
006	Circle	D diameter	2.0397	2.0511	2.0380	
007	Circle	D diameter	2.1352	2.0588	2.0527	
008	Circle	D diameter	2.6642	2.6457	2.6531	
009	Circle	D diameter	2.6699	1.9923	2.0680	
010	Circle	D diameter	4.0411	4.0433	4.0499	
011	Point-to-point	Distance	3.9562	3.9377	3.9419	
012	Point-to-point	Distance	6.6386	6.5318	6.5984	
013	Point-to-point	Distance	4.6149	4.6639	4.6138	

Fail/results sample

### Measurement Point Navigation for Replay Measurement

This function displays the direction and distance to the next measurement point, thereby eliminating any confusion on the part of the operator. The function additionally eliminates the need to check the next measurement point on the diagram each time, speeding the operator's workflow through a series of repeated measurements.

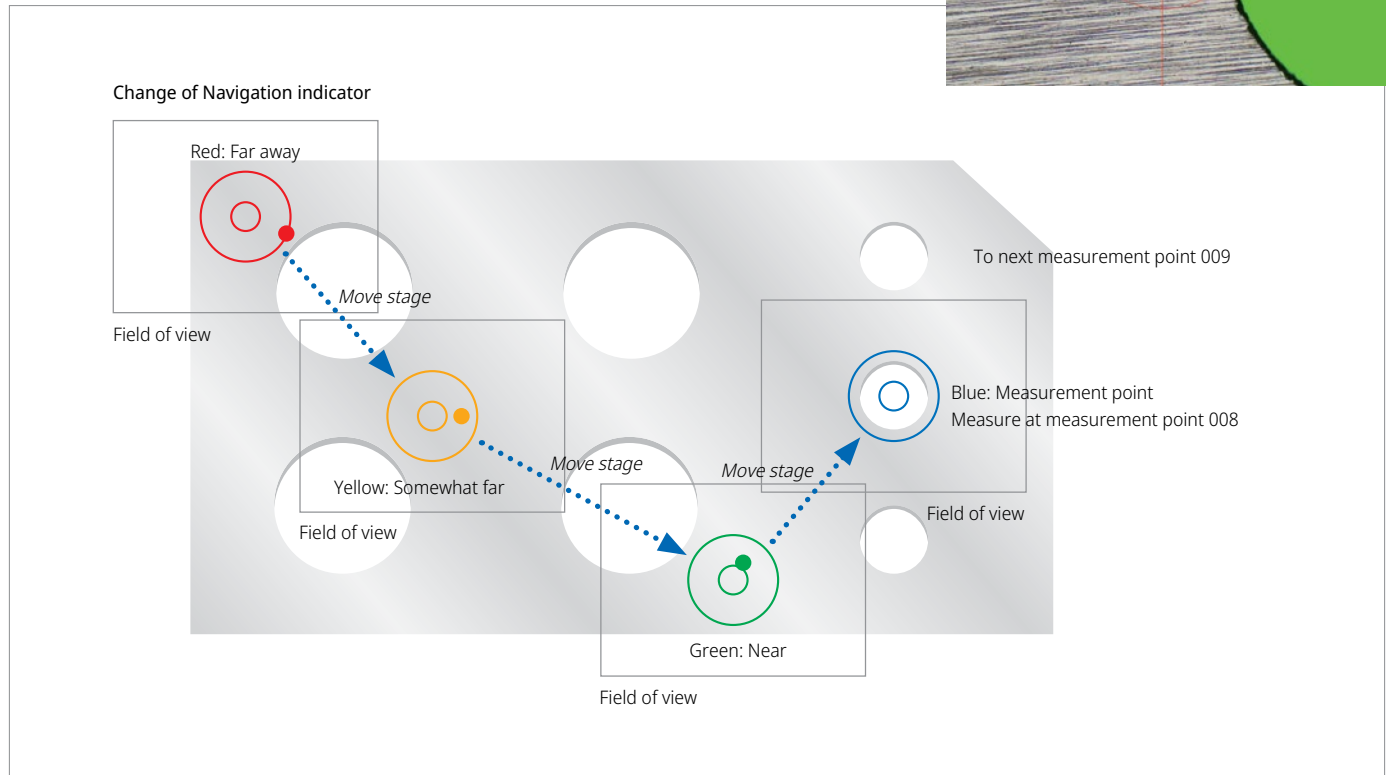
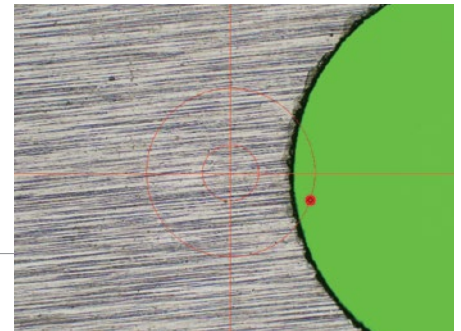
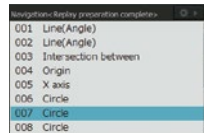



# Convenient Functions Help Eliminate Subjectivity in Measurement

## Automatic Edge Detection

This function detects the edges of the sample and automatically acquires and measures its coordinates. As a result, operators no longer need to designate the coordinates and subjectivity is minimized. Automatic Edge Detection also features a timer function that enables coordinates to be acquired in a specified time and supports the use of a foot switch that enables the operator to focus on measurement operations without taking their hands off the stage handles.

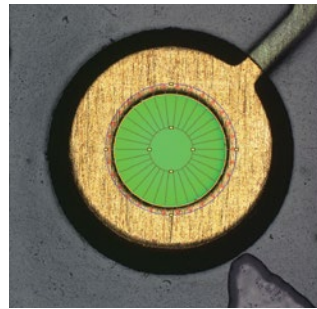

Automatic edge detection inside the circle

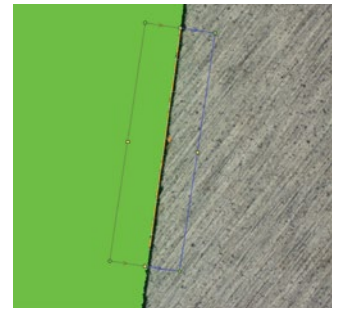

Multiple points automatic edge detection

## Abnormal Point Elimination

Metal burrs and other abnormal points can be excluded automatically during edge detection. This enables a consistent calculation of measured values, irrespective of the state of the sample. Points excluded as abnormal can also be displayed on the screen in different colors.

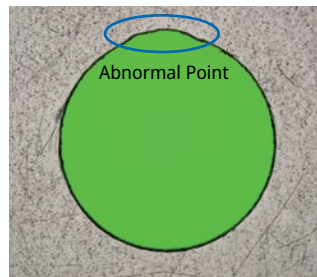

Sample with abnormal point

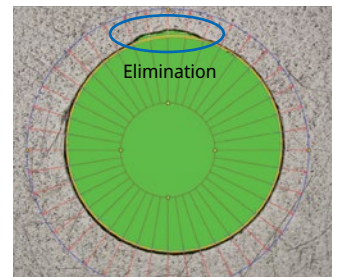

Abnormal point elimination

## Illumination Control

The light intensity of the microscope can be maintained by accurate software control. Light intensity settings can also be saved when recording a workflow, enabling measurements to be made under the same conditions during replay measurements or automatic edge detection.

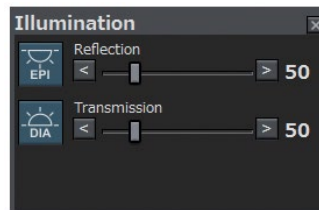

## Automatic Magnification Recognition\*

Through use of the coded revolving nosepiece, previously set calibration values are automatically recalled when changing the objective. In this way, the user can be confident that the proper scale is on display.

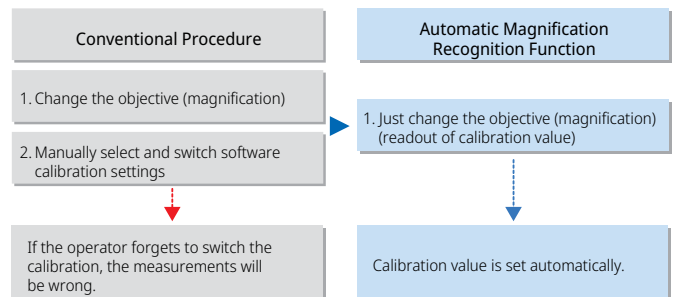

\*Optional with coded revolving nosepiece configuration only.

# Measurement Support Software

## Customizable Report Generation

### One-Click Report Generation

Measurement results can be output in Excel format with a single click, eliminating mistakes made during transcription. Images can also be pasted in along with the measurement results, enabling more efficient report generation.

The screenshot shows a software report window with a grid of images and a data table. The images include a top-down view of a sample, a side view, and two circular cross-sections. The data table below the images contains columns for various parameters such as 'Part Name', 'Part No.', 'Date', 'Operator', and 'Measurement Results'.

Report sample

### Multiple Image Alignment (MIA)\*

Tile multiple images to capture a single high-magnification, wide-area image. Because the images are tiled on the basis of coordinate data, the system is capable of producing highly reliable images.

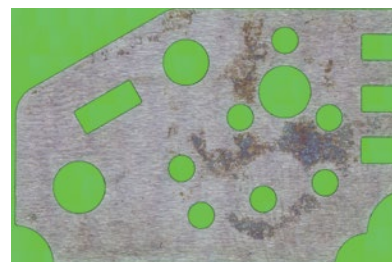
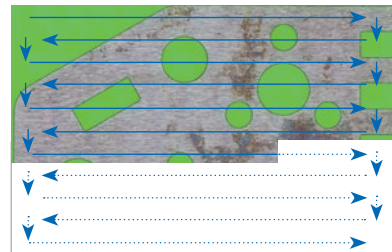

### Extend Focus Image (EFI)\*

The EFI function is effective for obtaining images that are well-focused throughout on samples with an uneven, complex surface shape. Generate a single image with focal points aligned in all positions. Simply process multiple images with different focal point positions while moving the Z-axis, or use the motorized model for automated image composition.

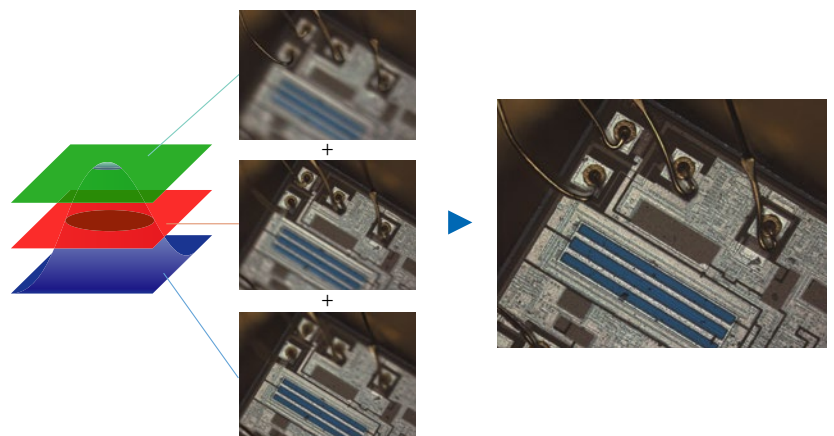

\*Optional software functions.

# Reliable Modular Systems

Five configurations provide you with flexibility to choose the features that you need.

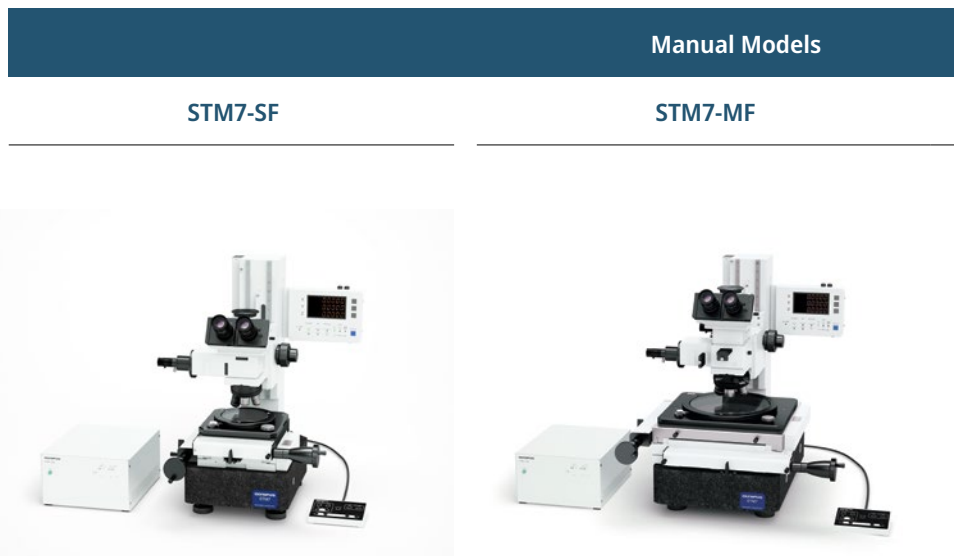

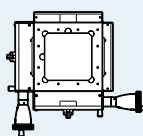
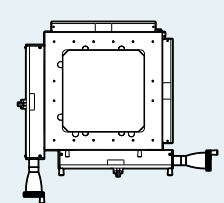
		STM7-SF	STM7-MF
<b>Stage (X x Y)</b>		<p><b>STM7-CS100</b></p>  <p>100 mm x 100 mm</p>	<p><b>STM7-CS200</b></p>  <p>200 mm x 200 mm</p>
<b>Z-axis focus</b>		<div style="background-color: #1a3d4d; color: white; padding: 5px; display: inline-block;">Manual</div>	
<b>Observation method</b> BF: Brightfield DF: Darkfield DIC: Differential interference contrast POL: Polarized light <small>*For objectives, refer to the specification table on pages 19–20.</small>	Standard	<div style="display: flex; justify-content: space-around; align-items: center;"> <div style="background-color: #1a3d4d; color: white; padding: 5px;">BF</div> <span>or</span> <div style="background-color: #1a3d4d; color: white; padding: 5px;">BF / DF</div> </div>	
	Option	<div style="display: flex; justify-content: space-around; align-items: center;"> <div style="background-color: #ccc; padding: 5px;">DIC</div> <div style="background-color: #ccc; padding: 5px;">POL</div> </div>	
Measurement objectives <b>Brightfield</b>		<input type="checkbox"/>	
Focus navigator <b>STM7-FN</b>		<input type="checkbox"/>	
Autofocus unit <b>STM7-AF</b>		—	
Measurement support software <b>STM7-BSW</b>		<input type="checkbox"/>	
Measurement support software (Multiple Image Alignment /MIA and Extended Focus Image/EFI) <b>STM7-ASW-ME</b>		<input type="checkbox"/>	

: Option

**Manual Models**

**STM7-LF**



**Motorized Models**

**STM7-MFA**



**STM7-LFA**



**STM7-CS300**

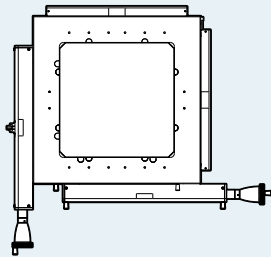

300 mm × 300 mm

**STM7-CS200**

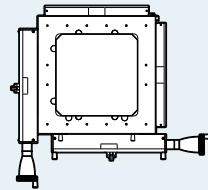

200 mm × 200 mm

**STM7-CS300**

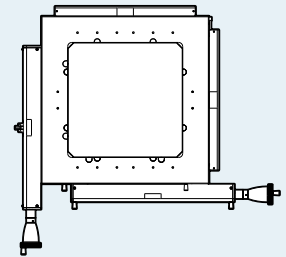

300 mm × 300 mm

**Manual**

**Motorized**

**BF**

or

**BF / DF**

**BF**

or

**BF / DF**

DIC

POL

DIC

POL





—

# STM7-F System Diagram (Manual Model)

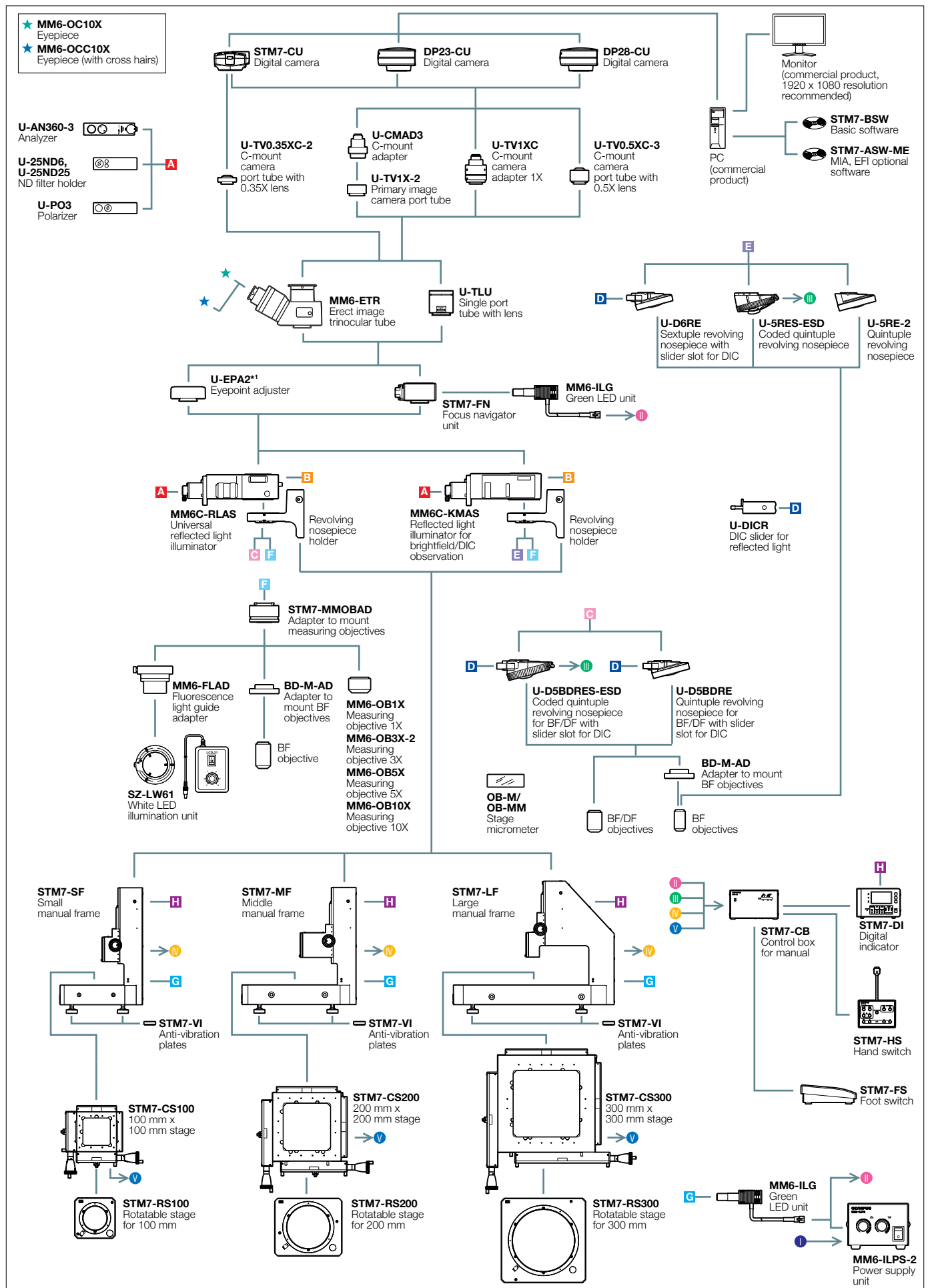

\*1 STM7-LF frame combination only. Max. two mountable.



# STM7-F System Diagram (Motorized Model)

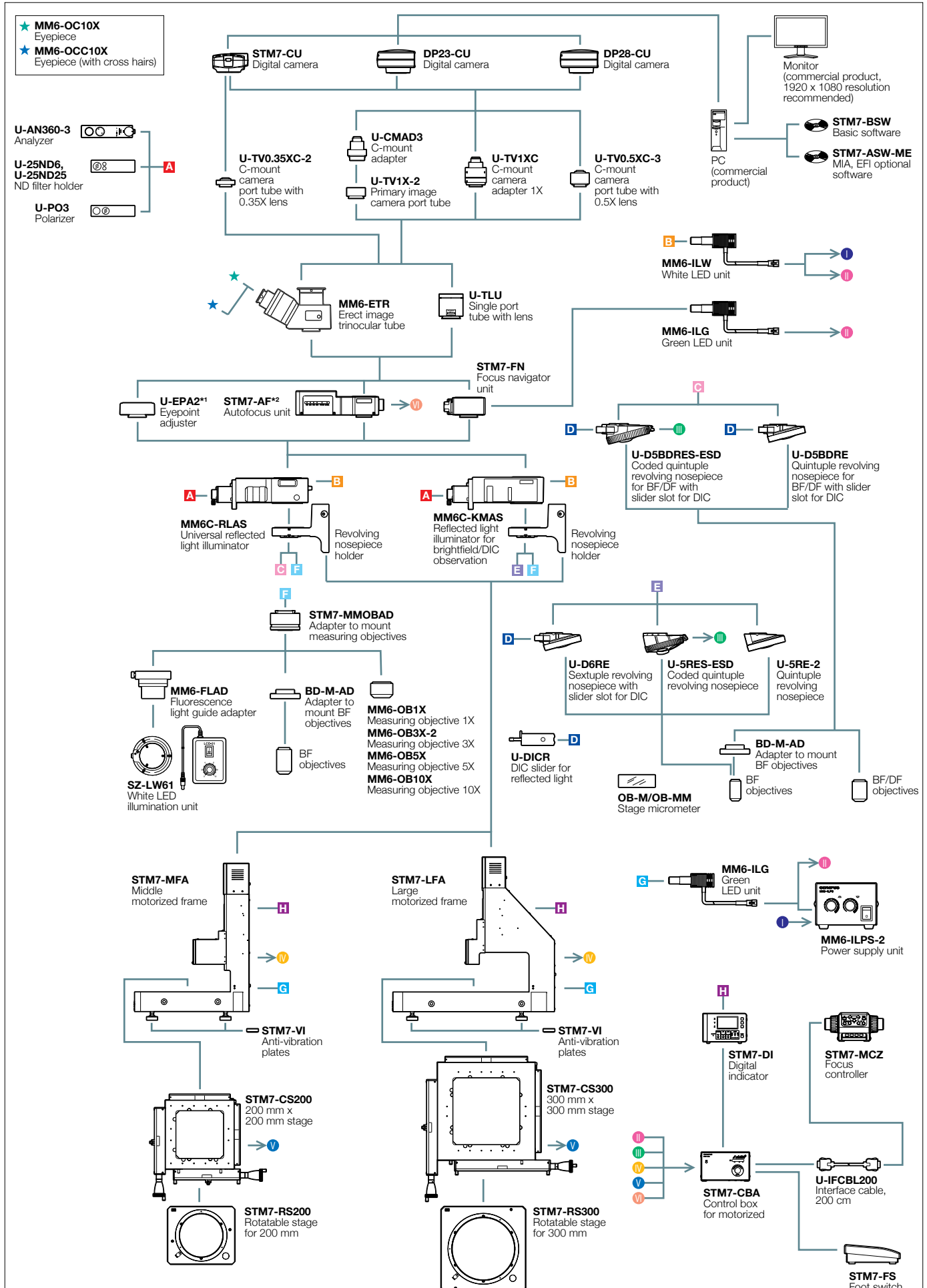

\*1 STM7-LFA frame combination only. Max. two mountable. \*2 STM7-AF autofocus unit is a Class 1 laser product.

# Specifications

## STM7 SPECIFICATIONS MANUAL MODEL

		Small stage	Midsized stage	Large stage
<b>Microscope body</b>		<b>STM7-SF</b>	<b>STM7-MF</b>	<b>STM7-LF</b>
Focus	Vertical movement range	175 mm		145 mm
	Maximum measurable height	120 mm (with measurement objective) 175 mm (with metallurgical objective)		90 mm (with measurement objective) 145 mm (with metallurgical objective) *1
	Z-axis measurement resolution	0.1 µm		
	Z-axis drive method	Manual coaxial fine/coarse focusing knobs		
Illumination	LED illumination			
<b>Observation tube</b>		MM6-ETR Erect image trinocular tube (100: 0/0: 100)		
<b>Eyepiece (FN 22)</b>		MM6-OCC10X (with cross hairs), MM6-OC10X		
<b>Objectives</b>	BF (Brightfield)	MM6C-KMAS Illumination		
		U-5RES-ESD Nosepiece		
	BF (Brightfield) /DF (Darkfield)	MPLFL5X, 10X, LMPLFLN20X, 50X, 100X Metallurgical objectives		
		MM6C-RLAS Illumination		
		U-5BDRES-ESD Nosepiece		
		LMPLFLN5XBD, 10XBD, 20XBD, 50XBD, 100XBD Metallurgical objectives		
<b>LED unit</b>	White color (reflected)	MM6-ILW		
	Green color (Tranmitted)	MM6-ILG		
<b>Stage</b>		<b>STM7-CS100</b>	<b>STM7-CS200</b>	<b>STM7-CS300</b>
	Measuring range	X-axis 100 mm, Y-axis 100 mm	X-axis 200 mm, Y-axis 200 mm	X-axis 300 mm, Y-axis 300 mm
	Measurement accuracy (L: measuring length)	(3 + 2L/100) µm	(3 + 4L/200) µm	(3 + 6L/300) µm
	Accuracy assurance weight	6 kg (13.2 lb)	10 kg (22 lb)	15 kg (33 lb)
<b>Counter</b>		<b>STM7-DI</b>		
	Number of axes	Three		
	Unit	µm/mm/inch/mil		
	Minimum resolution	0.1 µm		
	Control box	<b>STM7-CB</b>		
	Hand switch	<b>STM7-HS</b>		
	Focus controller	-		
Interface cable	-			
<b>Anti-vibration plates</b>		-	<b>STM7-VI</b>	
<b>Power cable</b>		UYCP		
<b>Dimensions (W x D x H)</b>		466 x 583 x 651 mm	606 x 762 x 651 mm	804 x 1024 x 686 mm
<b>Weight</b>		84 kg (185.2 lb)	152 kg (335 lb)	277 kg (610.7 lb)
<b>Power consumption</b>		100-120/220-240 V ~ 50/60 Hz 0.3 A/0.2 A	100-120/220-240 V ~ 50/60 Hz 0.3 A/0.2 A	100-120/220-240 V ~ 50/60 Hz 0.3 A/0.2 A

\*1 When using the large frame STM7-LF/STM7-LFA, a specimen whose height is 100 mm or less can be placed at the position backward from the light axis by 180 mm or more.

## OBJECTIVES WORKING DISTANCE

Objective	Magnifications	1X	3 X	5 X	10 X	20 X	50 X	100 X	
		<b>Measuring objectives</b>	MM6-OB series	59.6	76.8	65.4	50.5	-	-
<b>Metallurgical objectives</b>	MPLFLN series	Brightfield	-	-	20.0	11.0	3.1	1.0	1.0
	LMPLFLN series	Long working distance	-	-	22.5	21.0	12.0	10.6	3.4
	MPLFLN-BD series	Brightfield/darkfield	-	-	12.0	6.5	3.0	1.0	1.0
	LMPLFLN-BD series	Brightfield/darkfield, long working distance	-	-	15.0	10.0	12.0	10.6	3.3

## STM7-BSW SYSTEM REQUIREMENTS

Item	
<b>CPU</b>	Intel Core i3 Processors 3 GHz or more with an STM7-CU camera, an Intel CORE i5 or equivalent or higher with DP23/DP28 cameras
<b>Memory</b>	4 GB or more with an STM7-CU camera, 8 GB or more (16 GB recommended) with DP23/DP28 cameras.
<b>HD available space</b>	100 GB or more hard disk space for installation SSD hard disk is recommended for high speed image acquisition
<b>Graphic card</b>	Graphic card available for resolution 1980 x 1080 and 32bit color
<b>Drive</b>	DVD Drive
<b>PC input device</b>	2-button mouse (3-button mouse with a wheel is recommended.) Keyboard
<b>Operating system</b>	Microsoft Windows 10 Pro/Pro for Workstations (64bit)
<b>Web browser</b>	Internet Explorer 11

\* Microsoft Office 32-bit or 64-bit 2013/2016/2019/2021/365(SAC) are also supported.

**STM7 SPECIFICATIONS MOTORIZED MODEL**

		Midsize stage	Large stage
<b>Microscope body</b>		<b>STM7-MFA</b>	<b>STM7-LFA</b>
Focus	Vertical movement range	175 mm	145 mm
	Maximum measurable height	120 mm (with measurement objective) 175 mm (with metallurgical objective)	90 mm (with measurement objective) 145 mm (with metallurgical objective) *1
	Z-axis measurement resolution	0.1 μm	
	Z-axis drive method	Motorized ● FOCUS button: Coarse movement speed 8mm/s (max.) ● Fine/coarse focusing knob: Fine focusing speed can be selected from 4 values (800 μm, 400 μm, 100 μm, 50 μm)	
Illumination	LED illumination White: for reflected light illumination, green: for transmitted light illumination		
<b>Observation tube</b>		MM6-ETR Erect image trinocular tube (100: 0/0: 100)	
<b>Eyepiece (FN 22)</b>		MM6-OCC10X (with cross hairs), MM6-OC10X	
<b>Objectives</b>	BF (Brightfield)	MM6C-KMAS Illumination	
		U-5RES-ESD Nosepiece	
		MPLFL5X, 10X, LMPLFLN20X, 50X, 100X Metallurgical objectives	
	BF (Brightfield) /DF (Darkfield)	MM6C-RLAS Illumination	
U-5BDRES-ESD Nosepiece			
	LMPLFLN5XBD, 10XBD, 20XBD, 50XBD, 100XBD Metallurgical objectives		
<b>LED unit</b>	White color (reflected)	MM6-ILW	
	Green color (Tranmitted)	MM6-ILG	
<b>Stage</b>		<b>STM7-CS200</b>	<b>STM7-CS300</b>
	Measuring range	X-axis 200 mm, Y-axis 200 mm	X-axis 300 mm, Y-axis 300 mm
	Measurement accuracy (L: measuring length)	(3 + 4L/200) μm	(3 + 6L/300) μm
	Accuracy assurance weight	10 kg	15 kg
<b>Counter</b>		<b>STM7-DI</b>	
	Number of axes	Three	
	Unit	μm/mm/inch/mil	
	Minimum resolution	0.1 μm	
	Control box	<b>STM7-CBA</b>	
	Hand switch	—	
	Focus controller	<b>STM7-MCZ</b>	
Interface cable	<b>U-IFCBL200</b>	<b>U-IFCBL200</b>	
<b>Anti-vibration plates</b>		<b>STM7-VI</b>	
<b>Power cable</b>		<b>UYCP</b>	
<b>Dimensions (W x D x H)</b>		606 x 762 x 811 mm	804 x 1024 x 844 mm
<b>Weight</b>		159 kg	284 kg
<b>Power consumption</b>		100–120/220–240 V ~ 50/60 Hz 0.3 A/0.2 A	100–120/220–240 V ~ 50/60 Hz 0.3 A/0.2 A

\*1 When using the large frame STM7-LF/STM7-LFA, a specimen whose height is 100 mm or less can be placed at the position backward from the light axis by 180 mm or more.

<b>Option</b>	Objectives	Measurement objectives	MM6-OB series (1 X/3 X/5 X/10 X)	Rotatable stage	For 100 x 100 mm	STM7-RS100
	Focus navigator	Focus navigator unit	STM7-FN		For 200 x 200 mm	STM7-RS200
		Green LED unit	MM6-ILG		For 300 x 300 mm	STM7-RS300
	Autofocus	Autofocus unit	STM7-AF	ND filter	ND filte (Transmittance 6 %)	U-25ND6
	DIC	U-DICR DIC slider for reflected light	U-DICR		ND filte (Transmittance 25 %)	U-25ND25
	Software/Camera*1	Measurement Support Software	STM7-BSW	DIC	DIC/Polarizer	U-PO3
	Camera	Digital camera Low	STM7-CU		DIC/Analyzer	U-AN360-3
		Digital camera Middle	DP23-CU	Software	MIA, EFI optional software	STM7-ASW-ME
		Digital camera High	DP28-CU	Foot switch		STM7-FS
	TV adapter	C-mount camera port tube with 0.5X lens	U-TV0.5XC-3	Power supply unit		MM6-ILPS-2
C-mount camera port tube with 0.35X lens		U-TV0.35XC-2	Stage micrometer		OB-M/OB-MM	

\*1. Supported cameras vary depend on the version of STM7-BSW.  
Ver.1.3.3 or earlier: STM7-CU, Ver.1.4.1 or later: DP23/DP28

## Accessories



### STM7-AF Autofocus

The autofocus unit for the STM7 series that delivers excellent reproducibility and rapid focus.



### STM7-FN Focus Navigator

The focus navigator delivers highly reproducible height measurement by projecting a pattern within the field of view and identifying vertical deviations.



### U-DICR DIC Slider

The DIC slider provides topographic information about the sample with options to maximize contrast or resolution.



### Coded Revolving Nosepiece

Combining a coded revolving nosepiece with a digital camera lets you display the objective magnification on-screen during observation and allows you to record that magnification. This convenient feature allows information on your sample and the objective's magnification to be recorded at the same time when recording a sample.



### STM7-FS/ Foot Switch

Enables hands-free transmission of data, allowing operators to complete measurement without taking hands off the X and Y handles.



### SZ-LW61/ White LED Illumination Unit

This lightweight, space-saving design model provides a long operating life and low power consumption. The cost-effective LED illumination unit is also free from the flickering and brightness fluctuation.

### Rotatable Stage

Enables easy parallel alignment of sample.

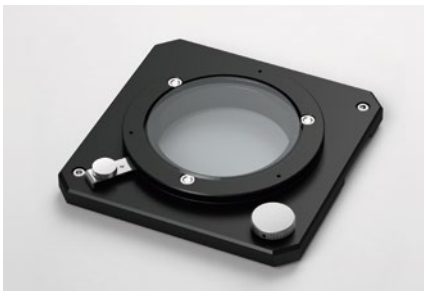

STM7-RS100  
for STM7-CS100 (100 mm × 100 mm stage)



STM7-RS200  
for STM7-CS200 (200 mm × 200 mm stage)



STM7-RS300  
for STM7-CS300 (300 mm × 300 mm stage)

# Dimensions

## STM7-SF

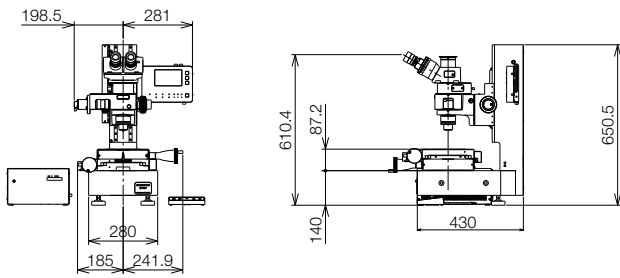

Unit: mm

## STM7-MF

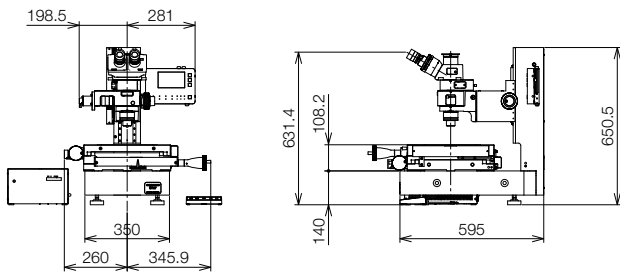

Unit: mm

## STM7-MFA

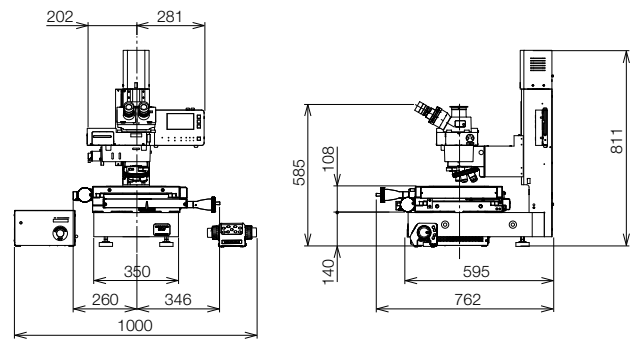

Unit: mm

## STM7-LF

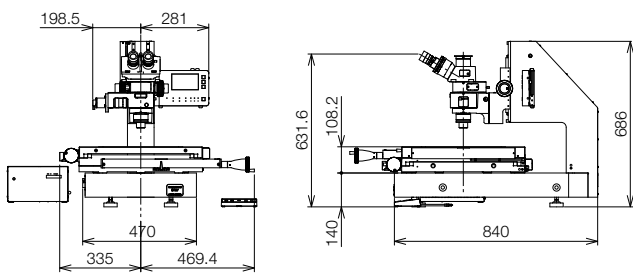

Unit: mm

## STM7-LFA

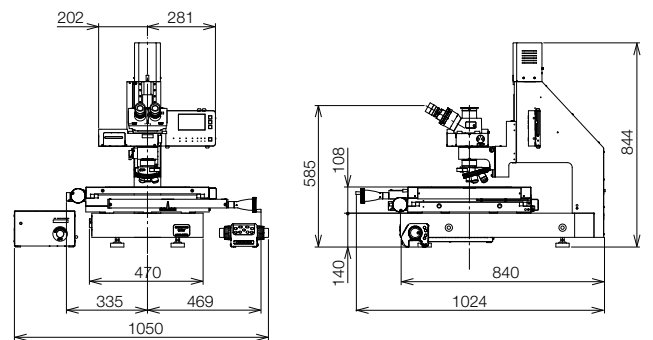

Unit: mm



- **EVIDENT CORPORATION is ISO14001 certified.**  
For details on certification registration, visit [olympus-ims.com/iso](http://olympus-ims.com/iso).
- **EVIDENT CORPORATION is ISO9001 certified.**

- This product is designed for use in industrial environments for the EMC performance. Using it in a residential environment may affect other equipment in the environment.
- All company and product names are registered trademarks and/or trademarks of their respective owners.
- Images on the PC monitors are simulated.
- Specifications and appearances are subject to change without any notice or obligation on the part of the manufacturer.
- Illumination devices for microscope have suggested lifetimes. Periodic inspections are required. Please visit our web site for details.

[EvidentScientific.com](http://EvidentScientific.com)

**EVIDENT**

**EVIDENT CORPORATION**

Shinjuku Monolith, 2-3-1 Nishi-Shinjuku, Shinjuku-ku, Tokyo 163-0910, Japan

**OLYMPUS**

M1796E-022024