

Customer Solutions

Inverted microscope possibilities for all your advanced metallurgical inspections

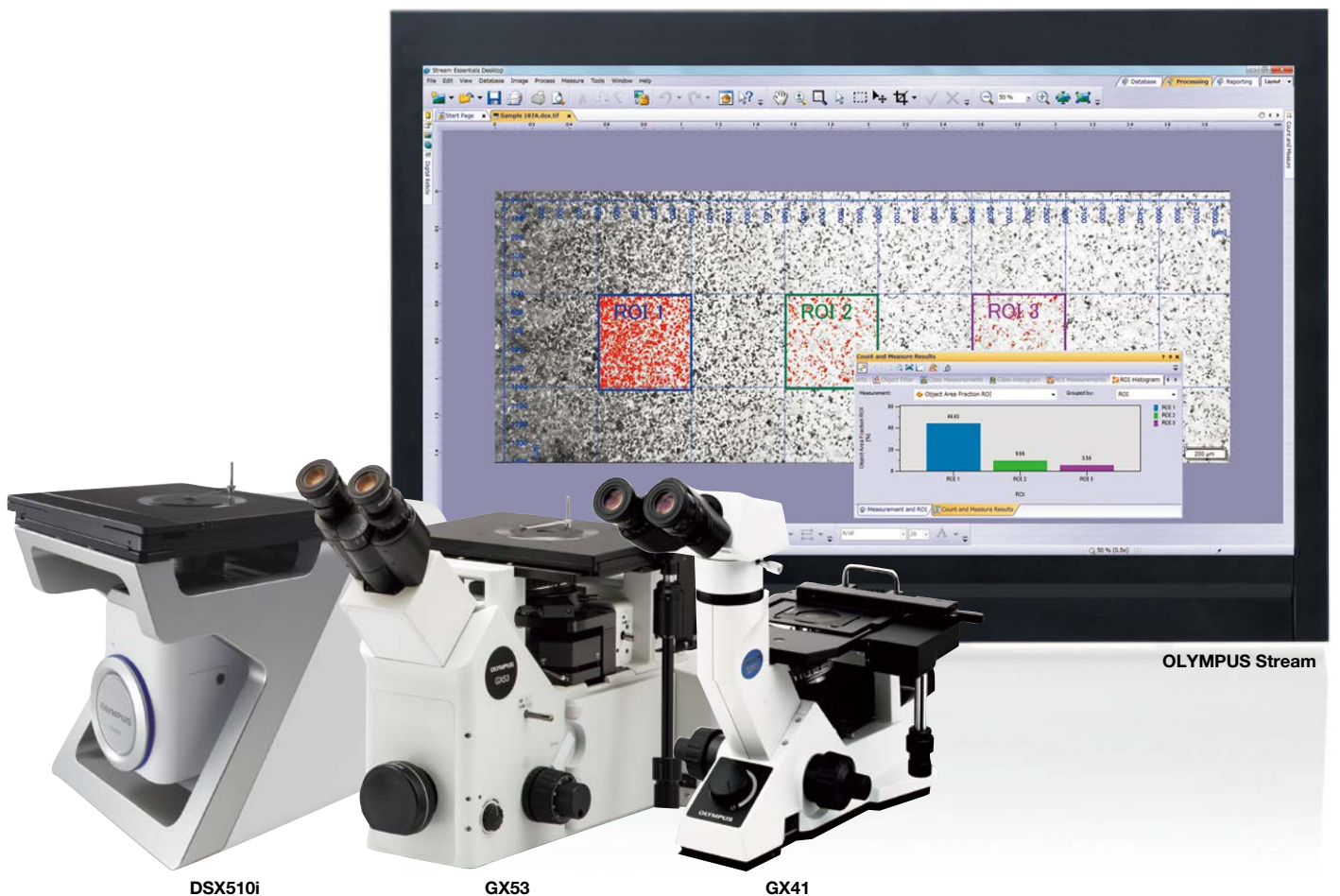

Why Choose an Inverted Microscope System?

Inverted microscopes are designed to observe samples from below, which are utilized in many fields such as steel, automotive, machinery, and electronics industries.

Observations can be easily and quickly conducted by facing and placing a sample onto the stage without leveling of the sample. The inverted microscopes can be used for large and heavy samples up to 5 kg, being suitable for observations at tens to thousands of magnification.

Typical Samples

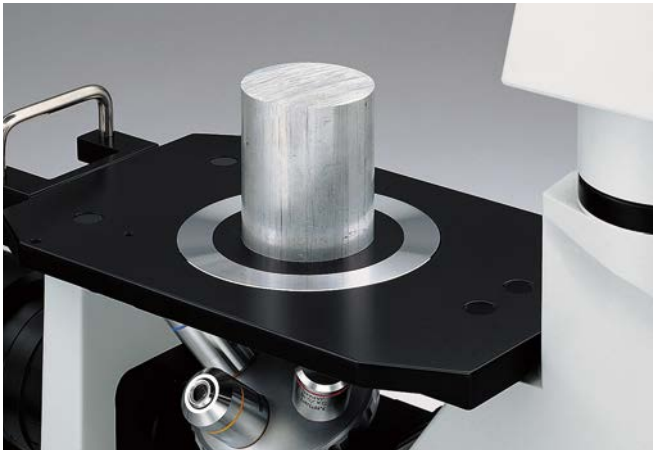

A large and heavy sample

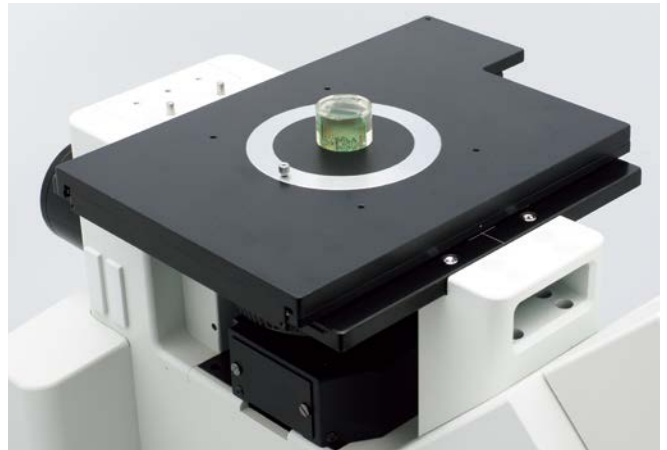

A cross-sectional sample

Examples of Application Images

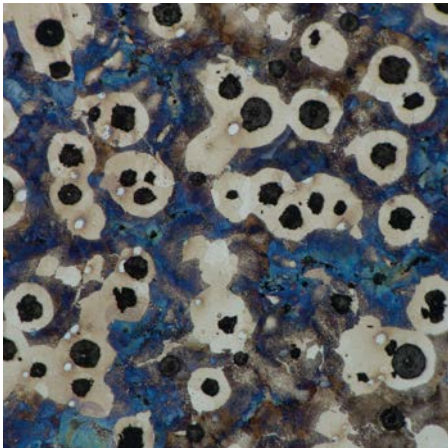

Nodular graphite cast iron

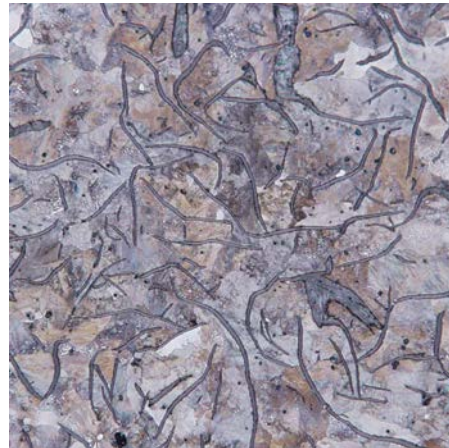

Gray cast iron

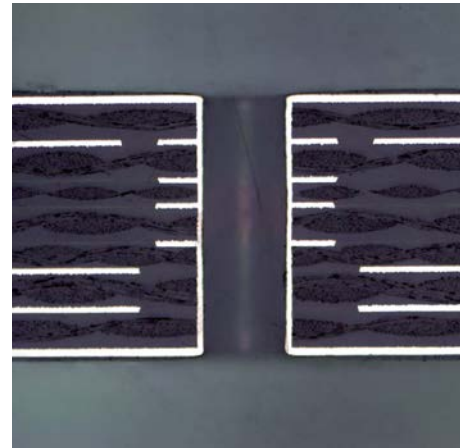

Multilayer board

Process to make a cross-sectional sample

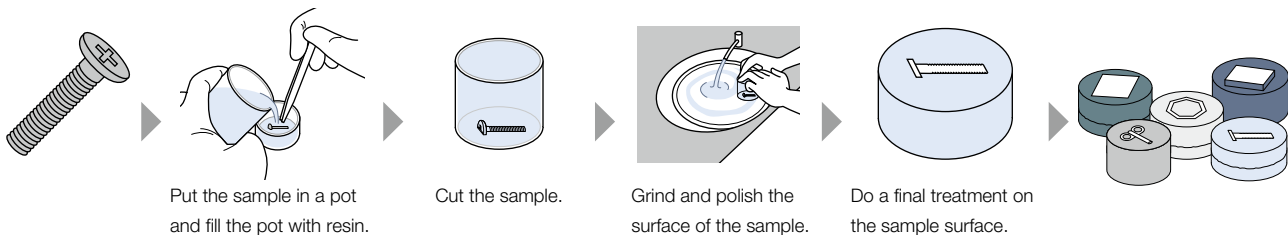

Examples of Metallurgical Analysis

OLYMPUS Stream image analysis software supports various metallurgical analysis methods following different industrial standards. The functional and user-friendly software delivers quick and easy inspections.

Grain Sizing in Microstructure

Grain size measurements and microstructure analysis of aluminum, steel crystal structures such as ferrite and austenite, and other different metals are available.

Applicable to the standards of ISO, ASTM, DIN, JIS, GOST, and GB/T.

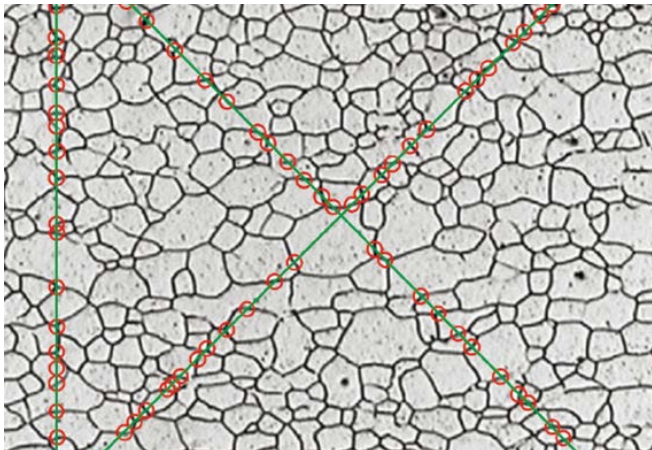

Microstructure of ferritic grains by the intercept counting method

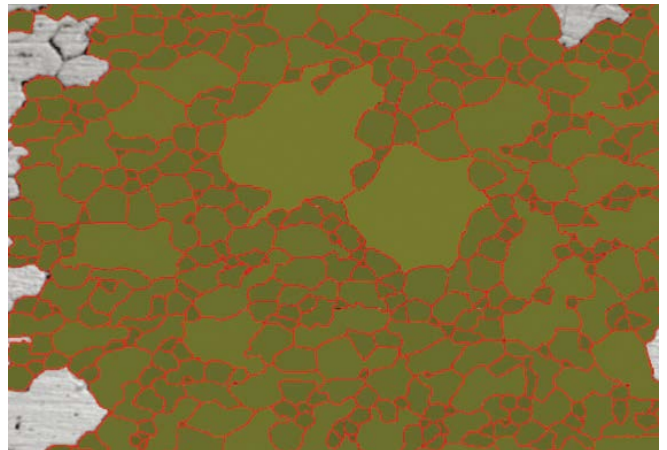

Microstructure with ferritic grains by the planmetric method

Graphite Nodularity Evaluation

Evaluations of graphite nodularity and content in cast iron samples (nodular and vermicular types) are available. The form, distribution, and size of graphite nodes can be classified. Applicable to the standards of ISO, ASTM, JIS, KS, NF, and GB/T.

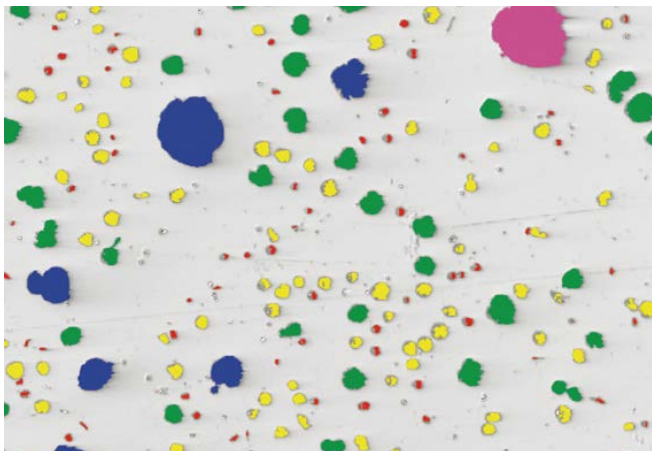

Cast iron solution
(Ductile cast iron showing nodular graphite)

Rating Non-Metallic Inclusion Content in High-Purity Steel

Classify non-metallic inclusions using the image of the worst field or worst inclusion found manually on the sample.

Applicable to the standards of ASTM, ISO, EN, DIN, JIS, UNI, and GB/T.

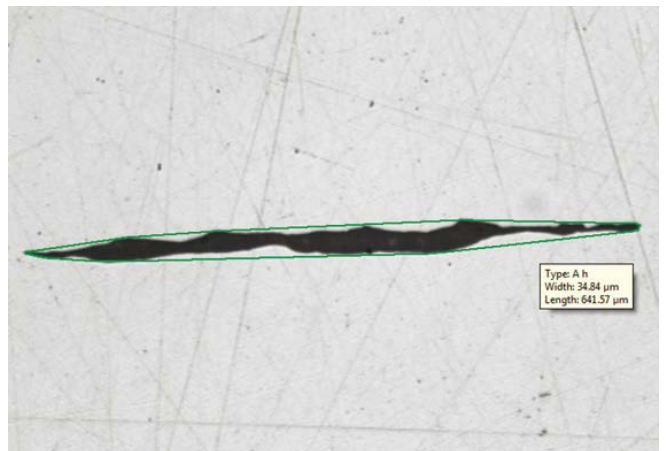

Inclusion worst field solution
(Steel with non-metallic inclusions)

Inverted microscopes have many uses in industry. Common cases include:

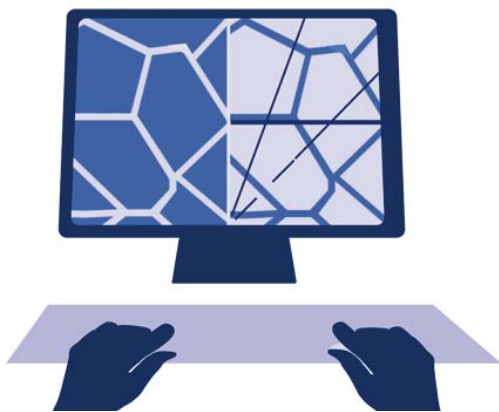
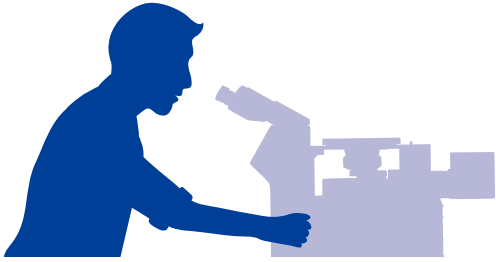

- Looking for tiny defects and scratches on parts
- Trying several observation methods to get an optimized image
- Observing glaring or low-contrast metals
- Sharing one microscope with multiple members in the workplace
- Multiple members conducting one inspection
- Inspecting a wide area such as metal flow and carburized metal
- Inspecting uneven surface samples
- Measuring objects, scratches, and defects of various sizes
- Particle analysis of metallographic structures
- Analyzing metallographic structures in accordance with international and/or company standards
- Making analysis reports after every inspection
- Comparing an observed image with a defined standard image

We offer a range of features to help make metallurgical inspections fast and efficient.



Observation

Defects and scratches invisible with conventional observation methods become visible. P5

Observation methods can be instantly switched. P6

Even with glaring or low-contrast samples, the textures and grain structures can be clearly observed. P7

Anyone can conduct microscopy inspections with a comfortable posture. P8

Inspectors at any experience level can deliver quality observations. P9



Image capture

Material conditions can be inspected at high magnification even for large areas. P10

Inspectors can obtain an entirely focused image with a rough surface sample. P11



Measurement

The reference scale on an observed image always synchronizes with the observation magnification. P12

Complicated particle analysis can be quickly and simply completed. P13

Any inspectors can correctly and easily conduct metallurgical analysis following defined standards. P14



Data sharing

Sophisticated reports can be generated using simple operations. P15

An observation image can be printed at a desired magnification. P16

Product Lineup



DSX510i
Digital microscope



GX53
Optical microscope



GX41
Compact optical microscope



OLYMPUS Stream
Image analysis software

Application

Looking for tiny defects and scratches on parts.

Depending on the material, scratches and defects sometimes require multiple observation methods to see them clearly. Using conventional illumination systems, users have to change between brightfield and darkfield observation, and often need to capture images of defects using each method.

Printed circuit board



Brightfield observation

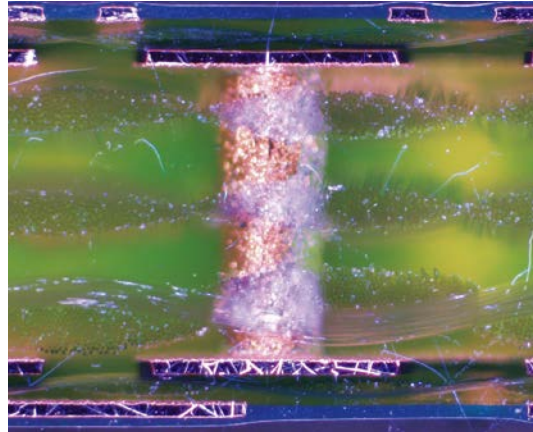

Darkfield observation

Solution

Defects and scratches invisible with conventional observation methods become visible.

Our MIX illumination helps make this inspection process faster and more efficient. MIX combines the capabilities of brightfield with directional darkfield observation to produce images showing scratches and defects. Directional darkfield allows for one or more quadrants of light to be shown at varying angles to highlight structure on different axes. You can simplify your reporting by capturing images using MIX instead of multiple images taken under multiple observation methods.

Applicable model(s): DSX510i, GX53

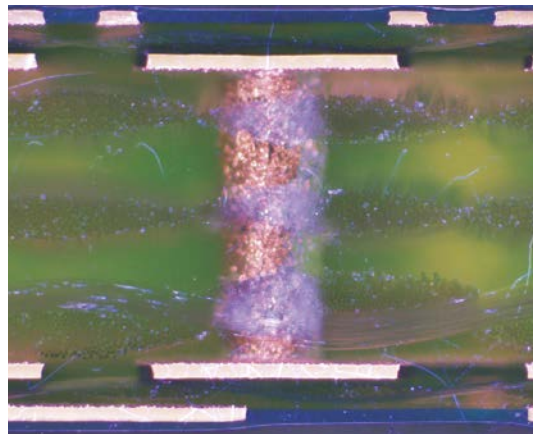

MIX observation:
All components are clearly visible.

Observation 02 | Switching observation method with one click

Application

Trying several observation methods to get an optimized image.

To observe various type metals and electric parts with optimized images respectively, inspectors try multiple observation methods such as brightfield, darkfield, polarized, DIC, and MIX observations.



Solution

Observation methods can be instantly switched.

The DSX automatically provides a selection of images with different observation methods that the user can choose from via the software. The DSX system enables any user to quickly and efficiently select a suitable observation method for their sample. Consequently, the DSX system significantly reduces the time required for observation with microscopes.

Applicable model(s): DSX510i

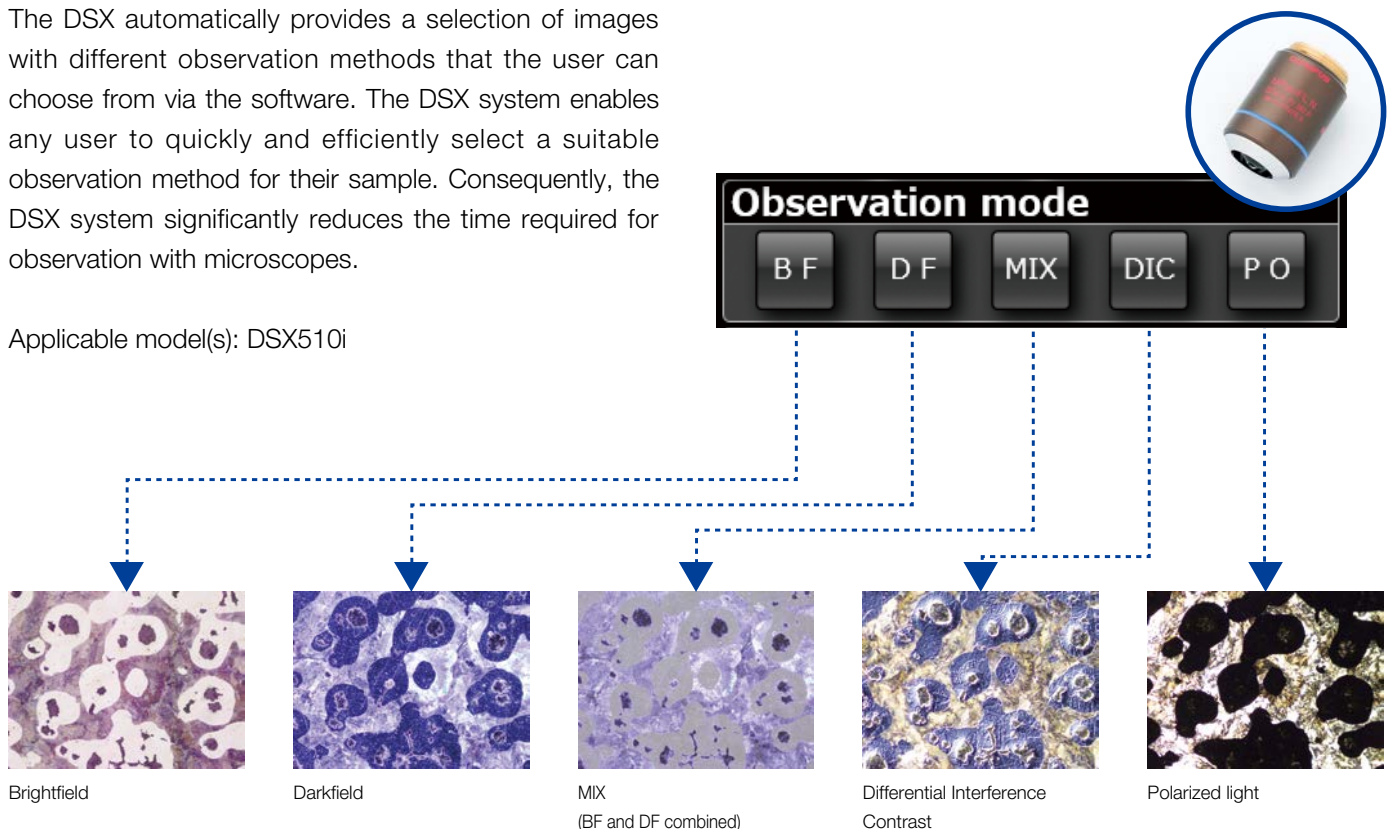

Application

Observing glaring or low-contrast metals.

Depending on the status of metallographic structures or etching conditions, it is sometimes difficult to acquire clear images of grain boundaries and material texture. The image quality may affect the judgment of acceptance and measurement results.

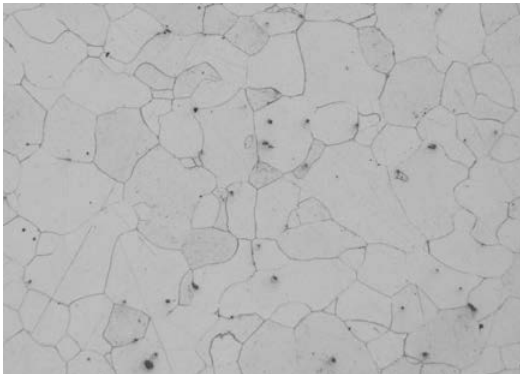
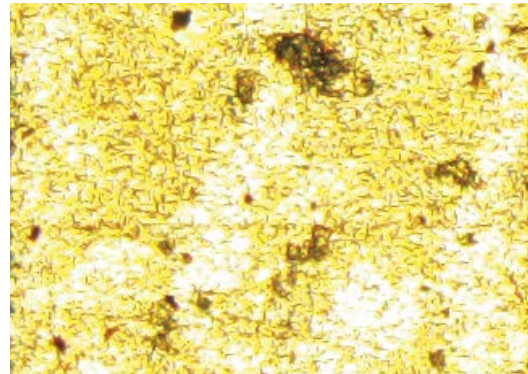

Image with blurred grain boundaries



Glaring gold plate

Solution

Even with glaring or low-contrast samples, the textures and grain structures can be clearly observed.

With HDR mode of the DSX system and OLYMPUS Stream, glaring sample and grain boundaries in metallographic structures, that are difficult to observe with conventional mode, can be observed clearly in detail. HDR improves the precision of the image allowing for better judgment of acceptance of the inspection results and measurement.

The time-consuming and troublesome process of re-etching the samples is notably reduced with HDR, while achieving more reliability in the data submitted to customers.

Applicable model(s): DSX510i, GX53+Stream, GX41+Stream

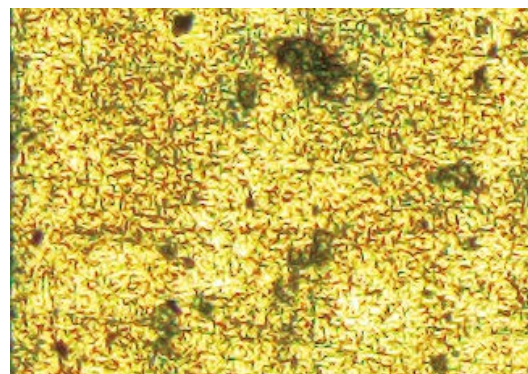
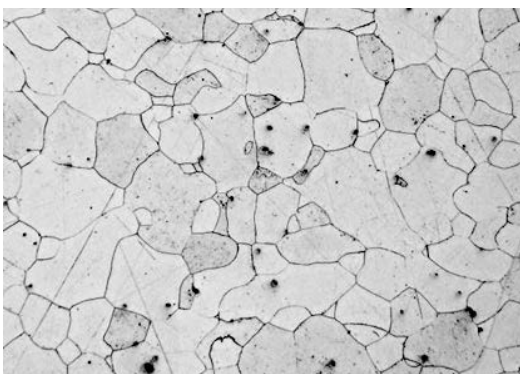

Clear and high contrast images by HDR function

Observation 04 | Flexible viewing posture

Application

Sharing one microscope with multiple members in the workplace.

It is common to share one microscope among team members. Inspectors sometimes need to look into the eyepieces with an unnatural posture during observations, which can slow down work speed.



Solution

Anyone can conduct microscopy inspections with a comfortable posture.

The tilting tubes of GX microscope systems are direction-adjustable and enable operators to place the tilting tubes at their own comfortable position. The flexible design provides low-fatigue and efficient inspections, and allows even quick inspections while standing.



Direction-adjustable tilting tubes

The GX41 portable microscope system can be carried to different desks and laboratories where you want to conduct inspections.

Applicable model(s): GX53, GX41



Portable system design

Application

Multiple members conduct a same inspection.

Multiple members in one team sometimes conduct a same inspection for a same purpose. It is difficult for everyone to always do same system adjustments and produce the same observation conditions and images. Observation conditions that differ depending on operators and/or timing will cause a variation in the observed images and inspection results.

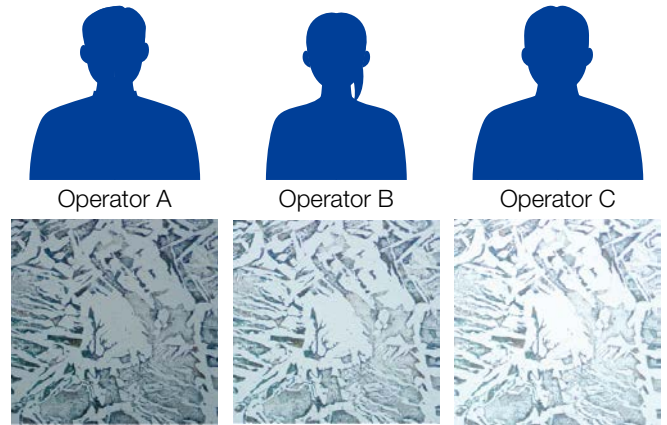

Variation among images observed by different operators

Solution

Inspectors at any experience level can deliver quality observations.

The DSX system and GX53 microscope with OLYMPUS Stream software enable users to save the image acquisition conditions along with the image itself. The settings associated with any saved image can be recalled with a single click from a saved image. Now, any user can conduct a reliable inspection for metallographic structures under consistently identical conditions and settings as used previously.

Applicable model(s): DSX510i, GX53+Stream

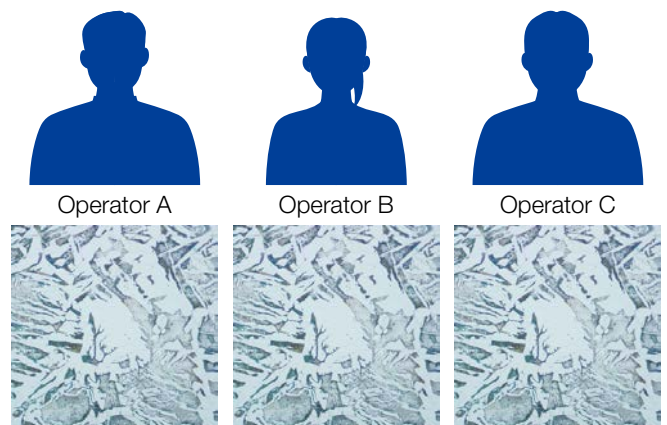

Even if inspectors are different, the observation image is the same

Application

Inspecting a wide area such as metal flow and carburized metal.

In metallurgical inspections, metal flow and carburizing conditions of samples are commonly inspected. In order to check these process conditions as much as possible, observations need to be done with a magnified image of a wide area.



Partial magnification of segments of the sample surface

Solution

Material conditions can be inspected at high magnification even for large areas.

The DSX system and OLYMPUS Stream software merge separate images automatically just by moving the stage, enabling you to acquire magnified images over an extensive area. This function makes it easy to acquire an image of the entire sample while significantly reducing the time and effort required. The resulting data is easy to understand and clear, making a contribution to smooth negotiations with customers.

Applicable model(s): DSX510i, GX53+Stream, GX41+Stream

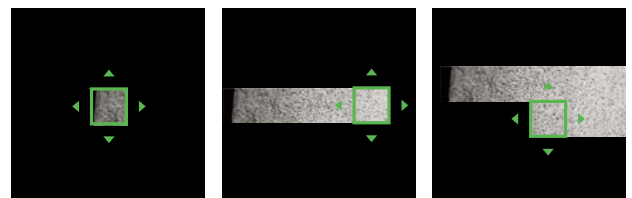

Depth and condition of carburizing can be identified.

Application

Inspecting uneven surface samples.

A sample surface needs to be evenly polished for microscopy observation with a fully-focused image. Creating the polished samples of metallographic materials requires both special technique and expertise. In particular, level differences are frequently found at boundaries between metallographic materials and the fixing resin.

There are often height differences in the boundary between the sample and resin.

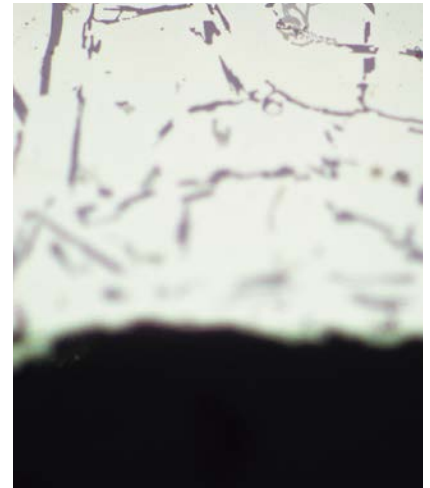
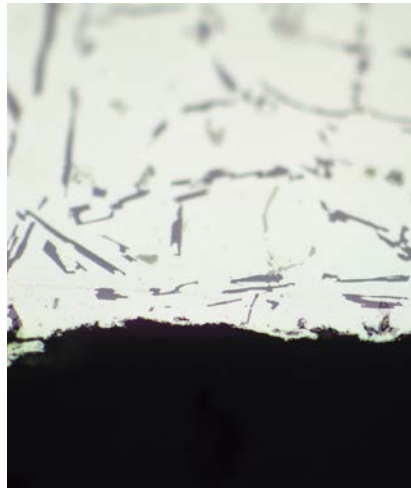

Polished sample of AlSi: Both images are partially focused.

Solution

Inspectors can obtain an entirely focused image with a rough surface sample.

The DSX system and OLYMPUS Stream software are capable of acquiring a fully-focused image of the entire sample regardless of unevenness or tilt on the polished surface. This eliminates the need for re-polishing the sample, leading to a significant reduction in effort and time.

Applicable model(s): DSX510i, GX53+Stream, GX41+Stream

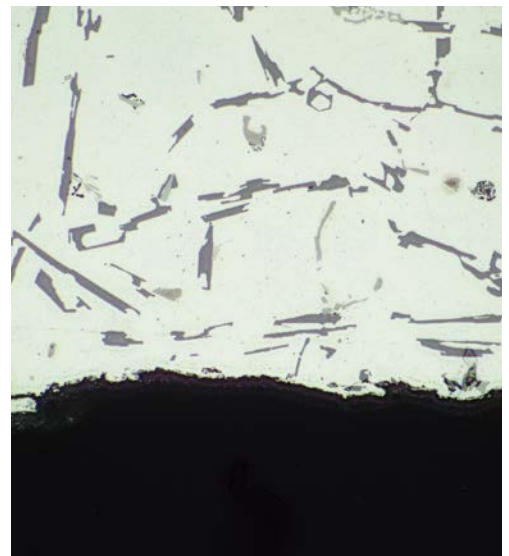

Fully-focused image of the entire sample regardless of irregularities on the polished surface

Application

Measuring objects, scratches, and defects of various sizes.

In most inspections, an inspector looks for defects or inspection points with a lower magnification image, and then inspects the details by switching the observation lens. For correct measurement, the reference scale on the observation image needs to match the selected objective lens.

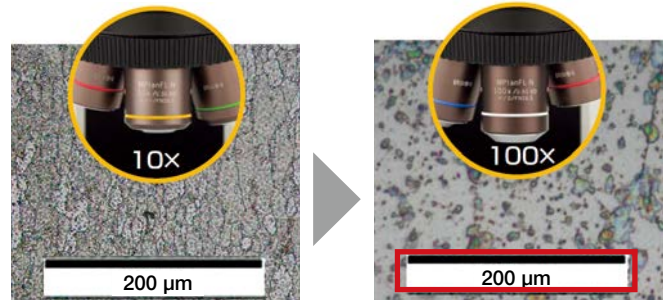

Though the observed magnification is changed, the magnification scale does not change.

Solution

The reference scale on an observed image always synchronizes with the observation magnification.

Setting the scale according to the magnification of the objective lens is the first step in correct image measurement. A coded nosepiece can automatically read the magnification information when changing the objective lens. This provides precise measurement at correct magnification, correct scale on monitor, correct measurement result on report.

Applicable model(s): DSX510i, GX53+Stream

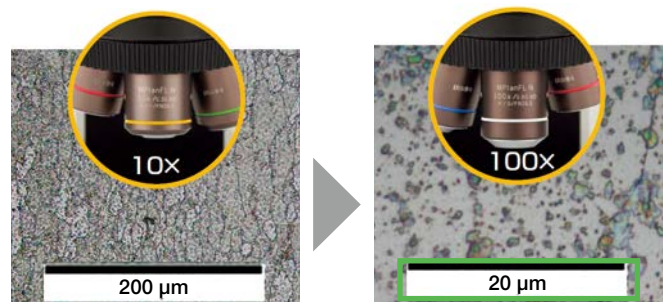

The magnification scale is changed in conjunction with the objective lens setting.

Application

Particle analysis of metallographic structures.

An image of metallographic structures often includes several thousands of grain particles. Even for simply counting grain particles or calculating the area ratio, the detection capability and functionality of the measurement and image analysis software greatly influences the inspection efficiency.

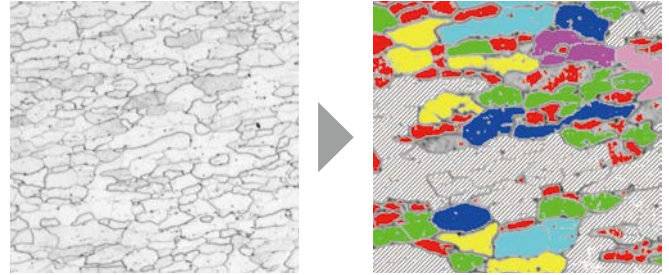

Etched steel whose grain boundaries are difficult-to-detect.

Solution

Complicated particle analysis can be quickly and simply completed.

With the powerful separation capability and wide variety of threshold settings available in the OLYMPUS Stream software, grain boundaries can be detected at high level, something that was very difficult to do in the past. After the grain particles are detected, the OLYMPUS Stream software measures and classifies the grain particles using more than 50 measurement parameters to dramatically improve inspection efficiency.

Applicable model(s): DSX510i+Stream, GX53+Stream, GX41+Stream

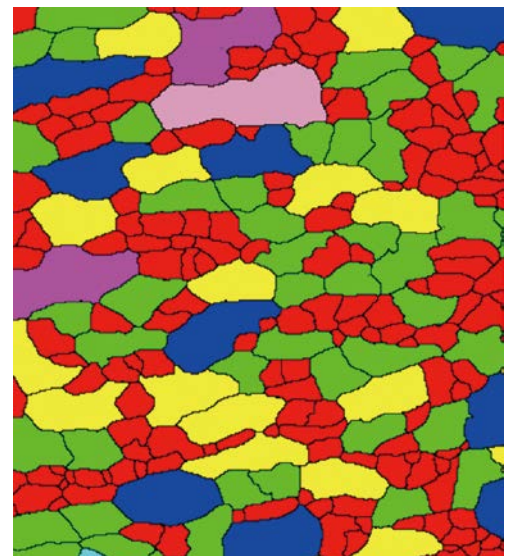
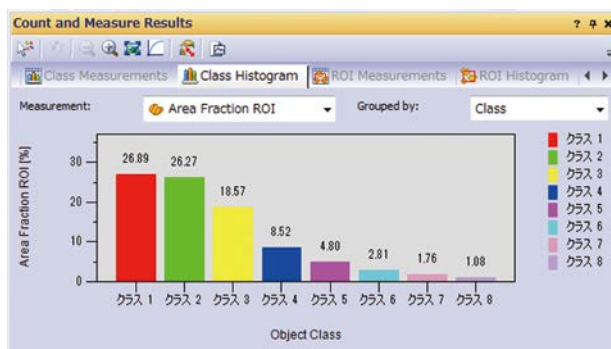

Clearly detected grain particles with a classification graph by area.

Application

Analyzing metallographic structures in accordance with international and/or company standards.

Expert inspectors are required to acquire full knowledge of metallographic analysis and the related standards, and generate reports according to the organization's guidelines. In order for all relevant members to properly complete the workflow, detailed operation training is essential.

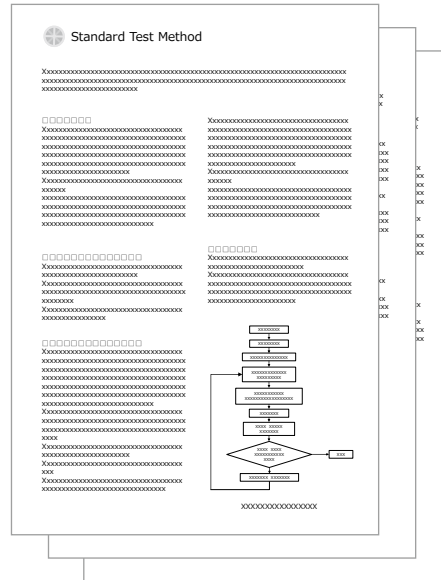

Metallographic analysis standards

Solution

Any inspectors can correctly and easily conduct metallurgical analysis following the defined standards.

The OLYMPUS Stream material solutions are optimized for dedicated purposes based on industrial standards, and guide the operator through each step of the workflow, including report generation. It solves the problem of having only a few experts who can carry out inspections.

Applicable model(s): DSX510i+Stream, GX53+Stream, GX41+Stream

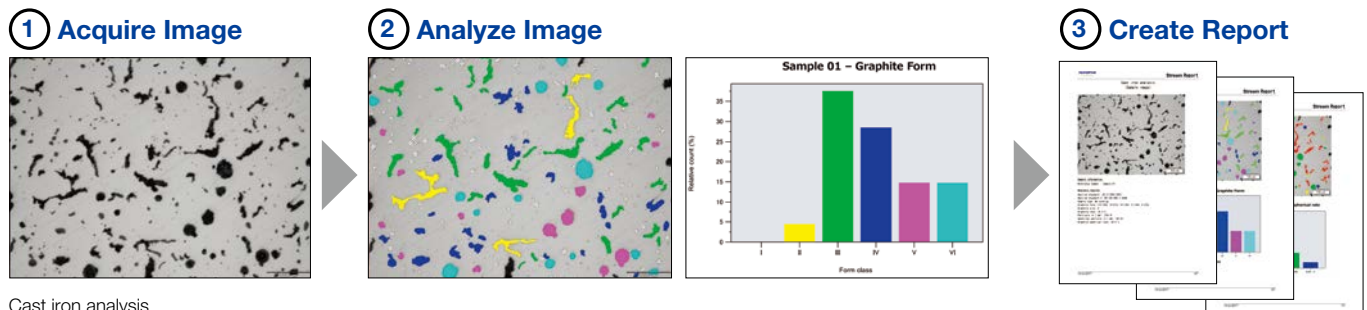

Application

Making analysis reports after every inspection.

Even though all the necessary information for the report is prepared, it still takes time after observations and measurements, to add images to the report, especially when manually adjusting the image size or aspect ratio, rewriting the measurement values, and adjusting the report layout.

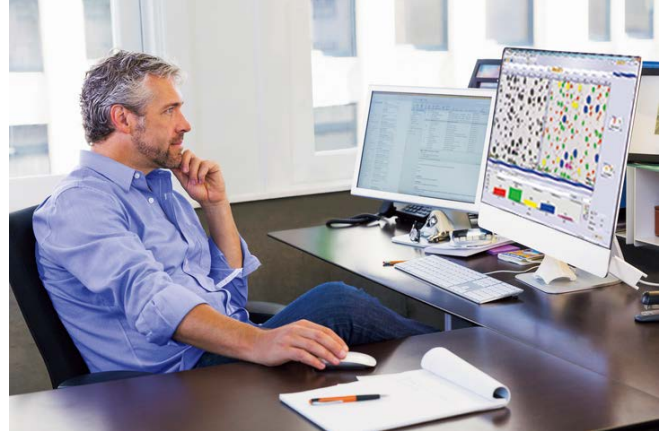

Solution

Sophisticated reports can be generated using simple operations.

OLYMPUS Stream software enables you to easily edit the report template however you want. It offers several ways to define the positions and sizes for images, tables, and graphs, and how they appear in the report.

Applicable model(s): DSX510i+Stream, GX53+Stream, GX41+Stream

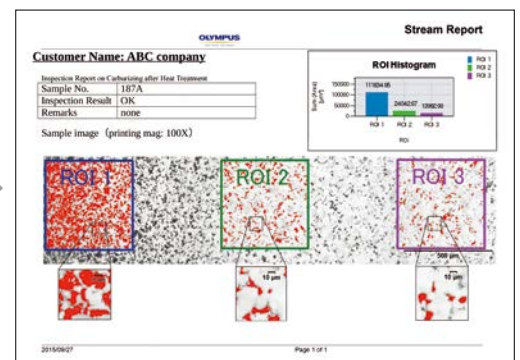
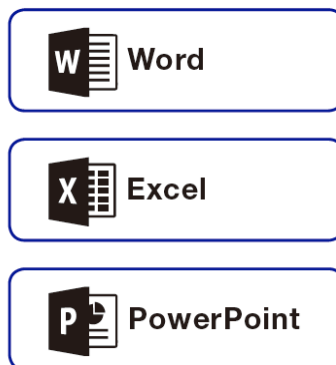
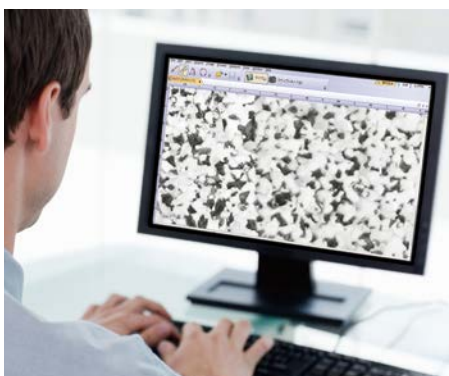

Sharing 12 | Print images with a desired magnification

Application

Comparing an observation image with the defined standard image.

In metallurgical inspections, an observed sample image must be compared with that of a reference sample defined by the industry or company standards. The comparison must be conducted at the same size and magnification with older film technology that is no longer available.

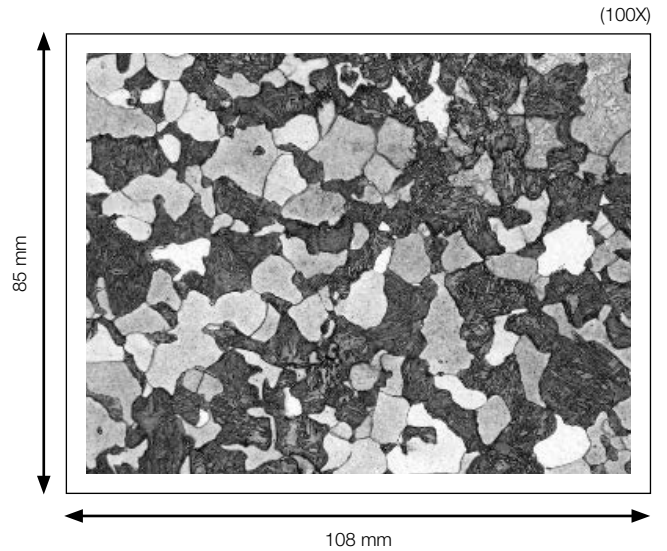

Solution

An observation image can be printed at a desired magnification.

OLYMPUS Stream software automatically considers image magnification and paper size. It is easy to directly print an image or create a report with an image using a user-defined printed magnification specification.

Applicable model(s): DSX510i+Stream, GX53+Stream, GX41+Stream

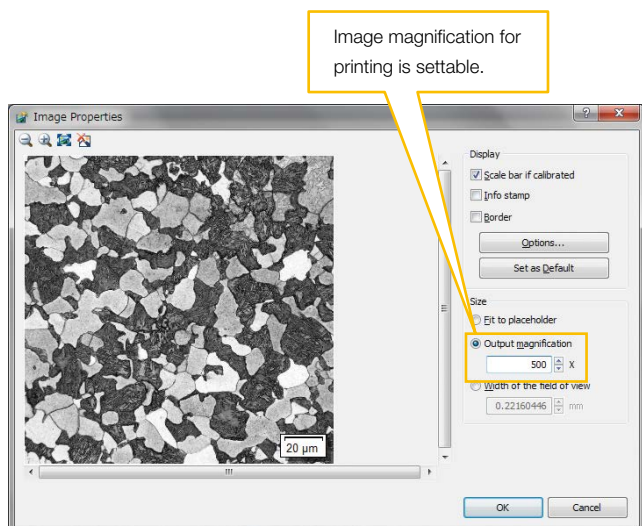

Magnification setting



Printing

Comparison Chart

■ Hardware, □ Stream

Solution		DSX510i	GX53	GX41
MIX observation		■	■	
Switching observation method with one click		■		
High dynamic range image		■	■+□	■+□
Flexible viewing posture (Eyepiece observation)			■	■
Easily restore system settings		■ Motorized	■+□ Manual	
Wider field of view		■	■+□	■+□
Images entirely in focus		■	■+□	■+□
Automatically switching magnification data		■	■+□	
Particle analysis for various needs		■+□	■+□	■+□
Guidance method for metallographic analysis		■+□	■+□	■+□
Report templates make reporting easy		■+□	■+□	■+□
Print images with a desired magnification		■+□	■+□	■+□
Specification		DSX510i	GX53	GX41
Reflected light illumination		White LED BF/DF/DIC/POL/MIX	White LED, Halogen, mercury lamp BF/DF/DIC/POL/MIX	Halogen BF/POL
Transmitted light illumination		—	White LED, Halogen BF/POL	—
Magnification switching method		Optical zoom system Zoom ratio 13.5X / Nosepiece system	Nosepiece system	Nosepiece system
FOV (μm)	Eyepiece observation (magnification)	—	17,600 - 146.666 μm (12.5X - 1,500X)	4,400 - 220 μm (50X - 1,000X)
	Monitor observation (magnification)	22,181 - 42 μm (17X - 9,014X)	*1	*1
Number of attachable objectives		2	4 - 7	4
Stopper		In/Out AS	AS, FS	AS
Precision (X-Y)	Accuracy (Magnification)	±3%	—	—
	Repeatability (Magnification)	3σ n-1= ±2%	—	—
Motorized stage	Travel range	50 x 25 mm	—	—
	Max. sample capacity	1 kg	—	—
Manual stage	Travel range	50 x 25 mm	50 x 50 mm	120 x 78 mm
	Max. sample capacity	1 kg	5 kg *2	5 kg
Insert plate	Hole shape	Long, teardrop	Circle, long, teardrop	
Z focusing structure		Motorized (AF, 3D)	Manual	Manual

*1 Total system magnification depends on camera and camera adaptor.

*2 Stage model: GX-SVR. The maximum sample capacity depends on the stage model.

Product Overview



DSX510i Digital Microscope

The advanced digital technology delivers superior image quality with superb operating simplicity, enabling users of any experience level to conduct advanced inspections. The intelligent interface is as simple as using a smartphone or tablet and backed by guaranteed accuracy and repeatability for 2D and 3D measurements.



GX53 Inverted Metallurgical Microscope

The GX53 inverted microscope features exceptional image clarity and resolution at high magnifications. With a range of accessories including coded revolving nosepiece and software solution, the modular design of the GX53 makes it easy to customize the microscope for your specific requirements at a small investment.



GX41 Compact inverted Metallurgical Microscope

The GX41 inverted metallographic microscope is ideal for quick and reliable specimen assessment and for determining if metallurgical properties meet manufacturing specifications. Its compact and light weight body enables portability.

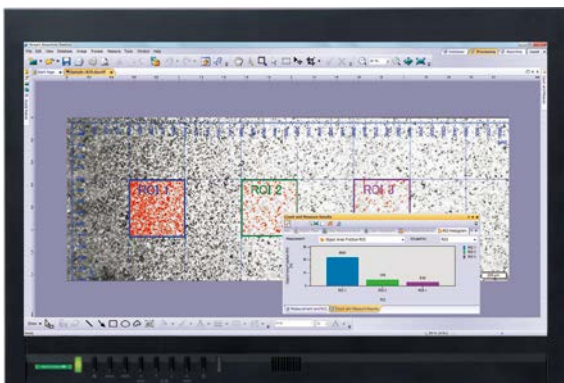

OLYMPUS Stream software

OLYMPUS Stream is an advanced material micro-imaging program that allows you to seamlessly acquire, process, and measure images, to create valuable data and reports. The software can easily be customized and provides sophisticated results with simple, flexible operation.

OLYMPUS offers an extensive product line for materials science and industrial microscopy. Learn more about the DSX series Digital Microscope and LEXT 3D Measuring Laser Microscope on our website, www.olympus-ims.com



OLS5000

NEW

LEXT 3D Measuring Laser Microscope

Power and speed are the hallmarks of the LEXT OLS5000 microscope. Owing to its high-resolution imaging and fast acquisition, the microscope delivers precise non-contact 3D observations and measurement of surface topography with impressive efficiency.



DSX510

DSX Upright Digital Microscope

The DSX500 with OLYMPUS Stream software is recommended for inspections of metallic materials having uneven surfaces, such as fracture cross-sectional areas.

- EVIDENT CORPORATION is ISO14001 certified.
- EVIDENT CORPORATION is ISO9001 certified.
- Illumination devices for microscope have suggested lifetimes. Periodic inspections are required. Please visit our website for details.
- This product is designed for use in industrial environments for the EMC performance. Using it in a residential environment may affect other equipment in the environment.
- All company and product names are registered trademarks and/or trademarks of their respective owners.
- Images on the PC monitors are simulated.
- Specifications and appearances are subject to change without any notice or obligation on the part of the manufacturer.

EvidentScientific.com

EVIDENT

EVIDENT CORPORATION
Shinjuku Monolith, 2-3-1 Nishi-Shinjuku, Shinjuku-ku, Tokyo 163-0910, Japan

OLYMPUS