

INSTRUCTIONS

取扱説明書

MM6-ILW/ILG/ILPS-2

LED ILLUMINATOR UNIT

LED照明装置

This instruction manual is for the Evident LED Illuminator unit model MM6-ILW/ILG/ILPS-2. To ensure the safety, obtain optimum performance and to familiarize yourself fully with the use of this attachment, we recommend that you study this manual thoroughly before operating the unit. Retain this instruction manual in an easily accessible place near the work desk for future reference.

このたびは、エビデントLED照明装置をご採用いただき、ありがとうございます。
本LED照明装置の性能を十分に発揮させるためおよび安全確保のため、ご使用前に必ずこの取扱説明書をお読みください。
LED照明装置使用時には、常に手元に置いていただき、お読みになったあとも大切に保管してください。

Optical Microscope Accessory

光学顕微鏡アクセサリ

This product is applied with the requirements of standard IEC/EN61326-1 concerning electromagnetic compatibility.

- Emission Class A
- Immunity Industrial electromagnetic environment

Emissions exceeding the level required by aforementioned standards may occur if this product is electrically connected to other equipment.

Some interference may occur if this product is used in residential environments.



In accordance with European Directive on Waste Electrical and Electronic Equipment, this symbol indicates that the product must not be disposed of as unsorted municipal waste, but should be collected separately. Refer to your local Evident distributor in EU for return and/or collection systems available in your country.

NOTE: This product has been tested and found to comply with the limits for a Class A digital device, pursuant to Part 15 of the FCC Rules. These limits are designed to provide reasonable protection against harmful interference when the product is operated in a commercial environment. This product generates, uses, and can radiate radio frequency energy and, if not installed and used in accordance with the instruction manual, may cause harmful interference to radio communications. Operation of this product in a residential area is likely to cause harmful interference in which case the user will be required to correct the interference at his own expense.

FCC WARNING: Changes or modifications not expressly approved by the party responsible for compliance could void the user's authority to operate the product.

For Korea only

A급 기기 (업무용 방송통신기자재)

이 기기는 업무용(A급) 전자파적합기기로서 판매자 또는 사용자는 이 점을 주의하시기 바라 며, 가정외의 지역에서 사용하는 것을 목적으로 합니다.

IMPORTANT

The LED Illuminator Unit has been developed to replace the Light Guide Light Source (MM6-LS22) for use with Evident Measuring Microscopes (STM6, STM6-LM).

The LED Illuminator Unit features a compact size, low power consumption and non-necessity of lamp bulb replacement.

As the instruction manual for the STM6 and STM6-LM refers to the previous light guide light source when it mentions the light source, please use this manual in place of the existing description on the light source.

Safety Precautions



1. Always use the power cord provided by Evident.
2. Always ground the equipment.
3. The power supply unit incorporates high-voltage parts inside. Do not open the cover of this unit to prevent electric shock.

Notes on the LED (Light Emitting Diode) Safety

It is discommended to stare at the light directly from the LED light source composed in this product for long hours as this could damage your eye. Use the equipment in accordance with the regulations for Workers Health and Safety, if any.

Safety Symbols

The following symbols are found on this unit. Study the meaning of the symbols and always use the equipment in the safest possible manner.

Symbol	Explanation
	Before use, carefully read the instruction manual. Improper handling could result in injury to the user and/or damage to the equipment.
	Indicates that the main switch is ON.
	Indicates that the main switch is OFF.

はじめに

このたび、測定顕微鏡 (STM6、STM6-LM) に付属のライトガイド光源装置 (MM6-LS22) を、このLED照明装置に切替えました。このLED照明装置は小型であり、省電力、ランプ交換不要といった特徴を持っています。STM6、STM6-LMの取扱説明書では旧ライトガイド光源装置で説明していますが、光源装置に関する説明部分についてはこの取扱説明書をご参照ください。

安全に関するお願い



- 1) 電源コードは当社付属のものを必ずご使用ください。
- 2) アースは必ず接続してください。
- 3) 電源ユニット内部には高い電圧の部分があり、感電のおそれがありますので、カバーは開けないでください。

LED (発光ダイオード) 安全に関するお願い

基本的には安全ではありますが、LEDユニットからの光を長時間にわたり直視すると眼を傷めるおそれがありますのでおやめください。また、労働者の健康および安全に関する法令がある場合は、それに従い装置を使用してください。

安全に関するシンボルマーク

LED照明装置には以下のマークが付いています。マークの意味をご理解いただき、安全な取扱いを行ってください。

マーク	意味
	使用する前に必ず取扱説明書をお読みください。 誤った取扱いをすると、使用者が障害を負ったり、商品の破損の原因となります。
	メインスイッチがON状態です。
	メインスイッチがOFF状態です。

Caution

If the unit is not used properly as instructed in this manual, the safety can no longer warranted and the unit may also fail. Be sure to use the unit as instructed in this manual.

The caution messages in this manual carry the following symbol.

▲ Caution for prevention of injury of the user or damage to the equipment (including properties in the surroundings).

Before disposing of this product, be sure to follow the regulations and rules of your local government.

注意

このLED照明装置を取扱説明書に記載されている以外の方法で使用されますと安全が保証できず更に故障のおそれがあります。この取扱説明書に従ってご使用ください。

本文内の注意文章には、次のシンボルマークを使用しています。

▲：使用者の障害防止および商品(周辺の家財などを含む)破損防止の注意内容を示しています。

本製品を廃棄する際は、地方自治体の条例または規則に従ってください。ご不明な点は、ご購入先のエビデントの販売店へお問い合わせください。

1 NOMENCLATURE

Power Supply Unit (MM6-ILPS-2)

- ① Main switch
I : ON. O : OFF.
- ② Brightness control
Turn clockwise to increase the light intensity.
△ : Transmitted light illumination
▽ : Reflected light illumination

White/Green LED Unit (MM6-ILW/ILG)

- ③ LED light emitter block
- ④ Connector

1 各操作部の名称と機能

電源ユニット (MM6-ILPS-2)

- ① メインスイッチ
I : ON O : OFF
- ② 調光つまみ
時計方向に回すと明るくなります
△ : 透過照明用
▽ : 落射照明用

白色/緑色LEDユニット (MM6-ILW/ILG)

- ③ LED光源出射部
- ④ コネクタ

Power Supply Unit
電源ユニット
MM6-ILPS-2

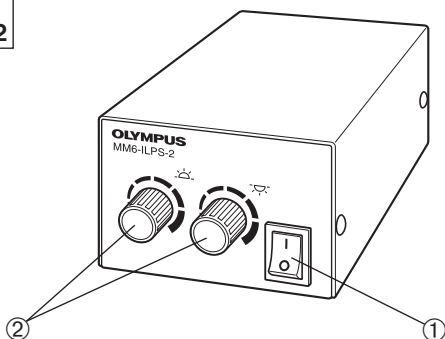

White/Green LED Unit
白色/緑色LEDユニット
MM6-ILW
MM6-ILG

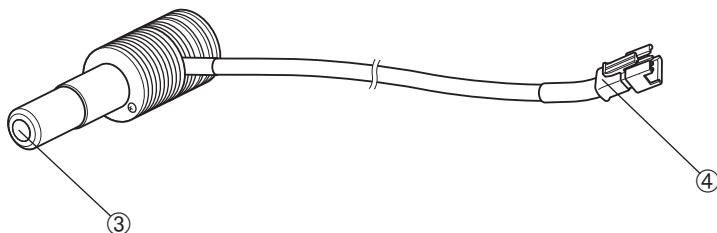

2 ASSEMBLY

- ▲ Cables and cords are vulnerable to bend or twist. Do not apply excessive force to them.
- ▲ Always use the power cord provided by Evident. If no power cord is provided, please select the power cord by referring to the section “PROPER SELECTION OF THE POWER SUPPLY CORD” at the end of this instruction manual. If the proper power cord is not used, Evident can no longer warrant the electrical safety performance of the equipment.

1 Installing the LED Light Emitter Block (Fig. 1)

1. When installing the White LED Unit (MM6-ILW) ①, insert it into the vertical illuminator unit and clamp with the clamping knob ②.
2. Fit the cable of the White LED Unit in the holder ③, giving it a certain slack so that it does not hinder the vertical movement of the Z-axis.
3. When installing the Green LED Unit (MM6-ILG) ④, insert it into the lower part of the main body and clamp with the clamping knob ⑤.

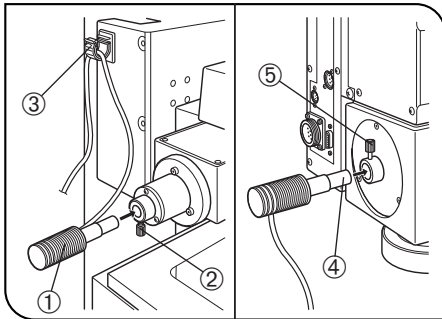

Fig. 1

2 組立て方法

- ▲ ケーブルは曲げ、ねじれに弱いので無理な力を掛けないように注意してください。
- ▲ 電源コードは当社付属のものをご使用ください。



1 LED光源出射部の取付け (Fig. 1)

- 1) 白色LEDユニット(MM6-ILW)①は落射照明ユニットに挿入し、固定つまみ②で固定します。
- 2) Z軸の上下動に支障がないように、白色LEDユニットのケーブルに余裕をもたせホルダ③に挟み込みます。
- 3) 緑色LEDユニット(MM6-ILG)④は本体背面の下部に挿入し、固定つまみ⑤で固定します。

2

Connecting the Power Supply Unit (Figs. 2 & 3)

▲Ensure that the main switch of the Power Supply Unit is set to “O” (OFF) before proceeding to the connection.

1. Insert the connector ① firmly into the OUTPUT connector ②.
 - White LED Unit: Insert into the connector marked .
 - Green LED Unit: Insert into the connector marked .
2. Connect the power cord ④ into the power inlet receptacle ③, and connect the power plug ⑤ of the power cord into the power outlet ⑥.

▲Connect the provided power cord correctly and ensure that the grounding terminal of the power supply and that of the 3-conductor wall outlet are properly connected. If the equipment is not grounded, Evident can no longer warrant the electrical safety performance of the equipment.

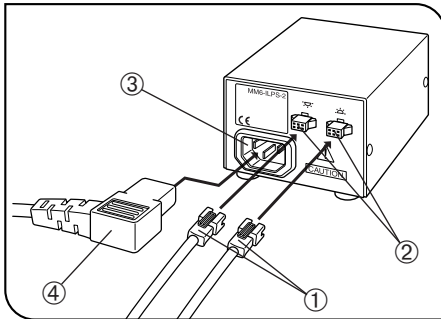



Fig. 2

2

電源ユニットの接続 (Figs. 2,3)

▲電源ユニットのメインスイッチがO (OFF) になっていることを確認してから接続してください。

- 1) コネクタ①をOUTPUTコネクタ②に確実に差し込んでください。
 - 白色LEDユニット→
表示のコネクタへ
 - 緑色LEDユニット→
表示のコネクタへ
- 2) 電源インレット③に電源コード④を取付け、電源プラグ⑤を電源コンセント⑥に差し込みます。

▲アース付3芯コンセントに必ず接続してください。コンセントのアースが未接続の場合は、当社の意図する電気安全性能が確保できません。

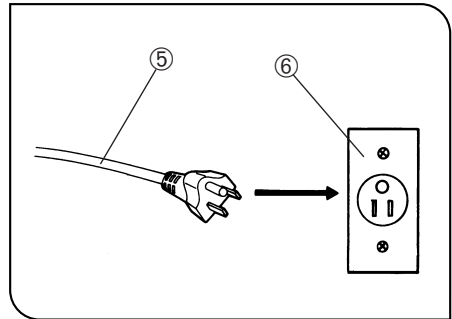

Fig. 3

3 SPECIFICATIONS

White/Green LED Unit

Model	MM6-ILW	MM6-ILG
LED color	White	Green
Color temperature/ Dominant wavelength	Max. 8000K Min. 5000K	Max. 550 nm Min. 520 nm
Dimensions	φ24 x 81.7 mm Cable length: 1500 mm	
Weight	80 grams	
Average life	Approx. 30000 hours (Ambient temperature 20°C, light intensity level 50%)	

Power Supply Unit

Model	MM6-ILPS-2
System	Constant-current lighting, 2 circuits
Output current variation	0 to 630 mA
Rated supply voltage	100-240 V AC 0.2-0.1 A, 50/60 Hz
Power consumption	10 W
Dimensions	95(W) x 132(D) x 55(H) mm (excluding projections)
Weight	550 grams

Common Specifications to MM6-ILW/ ILG/ILPS-2

Operating environment

- Indoor use.
- Altitude: Max. 2000 meters.
- Operating temperature/humidity: 5° to 35°C (50° to 95°F) 25% to 85%.
- Storage temperature/humidity: -20° to 60°C (-4° to 140°F) 20% to 85%.
- Supply voltage fluctuations: ±10%.
- Pollution degree: 2 (in accordance with IEC60664-1).
- Installation (overvoltage) category: II (in accordance with IEC60664-1)

3仕様

白色/緑色LEDユニット

Model	MM6-ILW	MM6-ILG
LED色	白	緑
色温度or ドミナント波長	Max:8000K Min: 5000K	Max: 550nm Min: 520nm
外観寸法	φ24×81.7mm ケーブル長さ：1500mm	
質量	80g	
平均寿命	約30000時間 (周囲温度20°C、調光50%使用時)	

電源ユニット

Model	MM6-ILPS-2
方式	定電流点灯方式 2系統
出力電流可変範囲	0~630mA
定格電圧	100-240V ~ 0.2-0.1A 50/60Hz
消費電力	10W
外観寸法	95(W)×132(D)×55(H)mm (突起部を除く)
質量	550g

MM6-ILW /ILG /ILPS-2共通

使用環境

屋内使用
標高2000mまで
動作周囲温度/湿度 5~35°C/25~85%
保存温度/湿度 -20~60°C/20~85%
電源電圧変動 ±10%
汚染度 2(IEC60664-1による)
設置カテゴリ(過電圧カテゴリ) II (IEC60664-1による)

PROPER SELECTION OF THE POWER SUPPLY CORD

If no power supply cord is provided, please select the proper power supply cord for the equipment by referring to "Specifications" and "Certified Cord" below:

CAUTION: In case you use a non-approved power supply cord for Evident products, Evident can no longer warrant the electrical safety of the equipment.

Specifications

Voltage Rating	125V AC (for 100-120V AC area) or, 250V AC (for 220-240V AC area)
Current Rating	6A minimum
Temperature Rating	60°C minimum
Length	3.05 m maximum
Fittings Configuration	Grounding type attachment plug cap. Opposite terminates in molded-on IEC configuration appliance coupling.

Table 1 Certified Cord

A power supply cord should be certified by one of the agencies listed in Table 1, or comprised of cordage marked with an agency marking per Table 1 or marked per Table 2. The fittings are to be marked with at least one of agencies listed in Table 1. In case you are unable to buy locally in your country the power supply cord which is approved by one of the agencies mentioned in Table 1, please use replacements approved by any other equivalent and authorized agencies in your country.



















Country	Agency	Certification Mark	Country	Agency	Certification Mark
Argentina	IRAM		Italy	IMQ	
Australia	SAA		Japan	JET	
Austria	ÖVE		Netherlands	KEMA	
Belgium	CEBEC		Norway	NEMKO	
Canada	CSA		Spain	AEE	
Denmark	DEMKO		Sweden	SEMKO	
Finland	FEI		Switzerland	SEV	
France	UTE		United Kingdom	ASTA BSI	
Germany	VDE		U.S.A.	UL	
Ireland	NSAI				

Table 2 HAR Flexible Cord

APPROVAL ORGANIZATIONS AND CORDAGE HARMONIZATION MARKING METHODS

Approval Organization	Printed or Embossed Harmonization Marking (May be located on jacket or insulation of internal wiring)		Alternative Marking Utilizing Black-Red-Yellow Thread (Length of color section in mm)		
			Black	Red	Yellow
Cornite Electrotechnique Belge (CEBEC)	CEBEC	⟨HAR⟩	10	30	10
Verband Deutscher Elektrotechniker (VDE) e.V. Prüfstelle	⟨VDE⟩	⟨HAR⟩	30	10	10
Union Technique de l'Electricite' (UTE)	USE	⟨HAR⟩	30	10	30
Instituto Italiano del Marchio di Qualita' (IMQ)	IEMMEQU	⟨HAR⟩	10	30	50
British Approvals Service for Electric Cables (BASEC)	BASEC	⟨HAR⟩	10	10	30
N.V. KEMA	KEMA-KEUR	⟨HAR⟩	10	30	30
SEMKO AB Svenska Elektriska Materielkontrollanstalter	SEMKO	⟨HAR⟩	10	10	50
Österreichischer Verband für Elektrotechnik (ÖVE)	⟨ÖVE⟩	⟨HAR⟩	30	10	50
Danmarks Elektriske Materialkontroll (DEMKO)	⟨DEMKO⟩	⟨HAR⟩	30	10	30
National Standards Authority of Ireland (NSAI)	⟨NSAI⟩	⟨HAR⟩	30	30	50
Norges Elektriske Materielkontroll (NEMKO)	NEMKO	⟨HAR⟩	10	10	70
Asociacion Electrotecnica Y Electronica Espanola (AEE)	⟨UNED⟩	⟨HAR⟩	30	10	70
Hellenic Organization for Standardization (ELOT)	ELOT	⟨HAR⟩	30	30	70
Instituto Portages da Qualidade (IPQ)	np	⟨HAR⟩	10	10	90
Schweizerischer Elektro Technischer Verein (SEV)	SEV	⟨HAR⟩	10	30	90
Elektriska Inspektoratet	SETI	⟨HAR⟩	10	30	90

Underwriters Laboratories Inc. (UL)
Canadian Standards Association (CSA)

SV, SVT, SJ or SJT, 3 X 18AWG
SV, SVT, SJ or SJT, 3 X 18AWG

Manufactured by

EVIDENT CORPORATION

6666 Inatomi, Tatsuno-machi, Kamiina-gun, Nagano 399-0495, Japan

Distributed by

EVIDENT EUROPE GmbH

Caffamacherreihe 8-10, 20355 Hamburg, Germany

EVIDENT EUROPE GmbH UK Branch

Part 2nd Floor Part A, Endeavour House, Coopers End Road, Stansted CM24 1AL, U.K.

EVIDENT SCIENTIFIC, INC.

48 Woerd Ave Waltham, MA 02453, U.S.A.

EVIDENT AUSTRALIA PTY LTD

97 Waterloo Road, Macquarie Park, NSW 2113, Australia

株式会社エビデント

EVIDENT Customer Information Center

お客様相談センター 受付時間 平日 9:00~17:00

☎ 0120-58-0414

※フリーダイヤルが利用できない場合
03-6901-4200

生物・工業用顕微鏡 E-mail: ot-cic-microscope@evidentscientific.com

その他の製品 E-mail: ot-cic-inspro@evidentscientific.com