

INSTRUCTIONS

LG-LSLED-RVI

LED light source unit

Industrial Endoscope Accessory

Manufactured by

Evident Corporation

6666 Inatomi, Tatsuno-machi, Kamiina-gun, Nagano 399-0495, Japan

Distributed by

Evident Europe GmbH

Caffamacherreihe 8-10, 20355 Hamburg, Germany

Evident Europe GmbH – UK Branch

Part 2nd Floor Part A, Endeavour House, Coopers End Road, Stansted CM24 1AL, UK

Evident Scientific, Inc.

48 Woerd Ave, Waltham, MA 02453, USA

Evident Scientific Singapore PTE. LTD.

#04-04/05, 25 Ubi Rd 4, UBIX Singapore 408621

Evident Australia PTY LTD

Level 4, 97 Waterloo Road Macquarie Park NSW 2113, Australia

Life science solutions

Service Center



[https://www.olympus-lifescience.com/
support/service/](https://www.olympus-lifescience.com/support/service/)

Official website



<https://www.olympus-lifescience.com>

Industrial solutions

Service Center



[https://www.olympus-ims.com/
service-and-support/service-centers/](https://www.olympus-ims.com/service-and-support/service-centers/)

Official website



<https://www.olympus-ims.com>

External standard

This product is applied with the requirements of standard IEC/EN61326-1 concerning electromagnetic compatibility.

- Immunity Industrial and basic electromagnetic environment

Emissions exceeding the level required by aforementioned standards may occur if this product is electrically connected to other equipment.

NOTE: This product has been tested and found to comply with the limits for a Class A digital device, pursuant to Part 15 of the FCC Rules. These limits are designed to provide reasonable protection against harmful interference when the product is operated in a commercial environment. This product generates, uses, and can radiate radio frequency energy and, if not installed and used in accordance with the instruction manual, may cause harmful interference to radio communications.

Operation of this product in a residential area is likely to cause harmful interference in which case the user will be required to correct the interference at his own expense.

FCC WARNING: Changes or modifications not expressly approved by the party responsible for compliance could void the user's authority to operate the product.

FCC Supplier's Declaration of Conformity

Hereby declares that the product

Product name: Industrial Endoscope Accessory

Model Number: LG-LSLED-RVI

Conforms to the following specifications:

FCC Part 15, Subpart B, Section 15.107 and Section 15.109

Supplementary Information:

This device complies with part 15 of the FCC Rules. Operation is subject to the following two conditions: (1) This device may not cause harmful interference, and (2) this device must accept any interference received, including interference that may cause undesired operation.

Responsible Party Name: Evident Scientific, Inc.

Address: 48 Woerd Ave Waltham, MA 02453, USA

Phone Number: 781-419-3900



In accordance with European Directive on Waste Electrical and Electronic Equipment, this symbol indicates that the product must not be disposed of as unsorted municipal waste, but should be collected separately.

Refer to your local Evident distributor in EU for return and/or collection systems available in your country.

For Korea only

이 기기는 업무용 환경에서 사용할 목적으로 적합성평가를 받은 기기로서 가정용 환경에서 사용하는 경우 전파간섭의 우려가 있습니다.

Contents

Introduction.....	1
Concept of this Instruction manual.....	1
Product Concept.....	2
Safety Precautions.....	3
Handling Precautions.....	6
1 Nomenclature of main operating portions.....	7
2 Operating procedures	8
2-1 Connecting the AC adapter and the power cord.....	8
2-2 Turning ON the main switch and adjusting the brightness....	9
3 Troubleshooting	10
4 Maintenance and storage.....	11
5 Specifications.....	12

Introduction

Concept of this Instruction manual

This instruction manual contains information for familiarizing the operation and handling of this product and for using it safely.

Please read this instruction manual carefully before using and the instruction manual of the scope to be used in combination and use it properly.

After reading, carefully keep it with the warranty card and read it when necessary.

If you have any questions about any information in this manual, please contact Evident.

Applicable user of this Instruction manual

This instruction manual applies to users who use this product according to "Intended use" and Evident distributors.

How to read this Instruction manual

Note that use of this instrument in ways that are not specifically described in this instruction manual does not ensure the safety and it may also cause the malfunction of this instrument. Be sure to follow this instruction manual when using this instrument.

The following symbols are used throughout this instruction manual.

 **DANGER** : Indicates an imminently hazardous situation which, if not avoided, will result in death, serious injury or damage of observation object.

 **WARNING** : Indicates a potentially hazardous situation which, if not avoided, could result in death, serious injury or damage of observation object.

 **CAUTION** : Indicates a potentially hazardous situation which, if not avoided, may result in minor or moderate injury. It may also be used to alert against unsafe practices or potential material damage.

 **NOTE** : Indicates a potential situation which, if not avoided, may result in failure of this instrument.

 **TIP** : Indicates additional helpful information.

Product Concept

Product outline

This LG-LSLED-RVI (LED light source) can illuminate the inspection object by combining the Evident industrial fiberscope or industrial rigid borescope.

Intended use

This product is designed as an illumination device for the industrial fiberscope or the industrial rigid borescope.

This product is intended to be used in combination as a system, refer to the instruction manual for the system product to be combined.

Cautions and confirmation before use

This product includes the following items. If any item is missing or damaged, contact Evident.

- Instruction manual for LG-LSLED-RVI (this instruction manual)
- AC adapter

Safety Precautions

If the product is used in a manner not specified by this manual, the safety of the user may be imperiled. In addition, the product may also be damaged. Always use the product according to this instruction manual.

Installation

DANGER

- **Never use the instrument in the following environments.**
 - Where flammable atmospheres are present
 - Where metal dust or other dust is present
- Otherwise, an explosion or fire may result.

WARNING

- **Do not block the air vents.**
 - Do not install the product on a table or bench which has soft surface, as the product may sink and the air vents of the bottom surface may be blocked, which creates a fire hazard.
 - Do not to block the air vents on the back of the product. Secure the space of 10 cm or more around the air vents.

CAUTION

- **Install the product on a level table or bench.**
- **Do not use the product in places where it is liquid.**
 - Electric shock, fire, product failure may result.
- **Do not use the AC adapter outdoors.**
 - Otherwise, electric shock, smoke or fire may occur, which may cause damage to the instrument. The AC adapter is designed for indoor use.

Prevention of electric shock

WARNING

- **Never disassemble each part of this product.**

It could cause electric shock or failure of the product.
- **Do not touch the product with wet hands.**

In particular, if you touch the main switch of the power unit or the power cord with wet hands, electric shock, ignition or failure of the product may be caused.
- **Do not bend, pull or tie the power cord/cables in a bundle.**

Otherwise they could be damaged, causing a fire or an electric shock.
- **Never insert any tools or metal fragments in the air vents of the product.**

As this product contains the cooling fan, if you insert metal fragments or similar, the fan may be damaged or fire may be caused.

Electric safety

CAUTION

- **Always use the AC adapter and the power cord provided by Evident.**
If the proper AC adapter and the power cord are not used, the electric safety and the EMC (Electromagnetic Compatibility) performance of the product cannot be assured. If no power cord is provided, please select the proper power cord by referring to the section "Proper selection of the power cord" at the end of this instruction manual.
- **Always connect the ground terminal.**
Make sure that the ground terminal of the power cord and that of the power outlet are connected properly. If the product is not grounded, our intended electric safety and EMC performance of the product cannot be assured.
- **Do not use the product in close proximity to the sources of strong electromagnetic radiation.**
Proper operation may be interfered. The electromagnetic environment should be evaluated prior to operation of the product.
- **Disconnect the power cord in case of emergency.**
In case of emergency, disconnect the power cord from the power cord connector on the product or from the power outlet.
Install the product at the location where you can reach the power cord connector or the power outlet at hand to disconnect the power cord quickly.
- **Do not connect or disconnect the power cord, cables and products (optional) while the power is on.**

LED

This product emits high-intensity visible light. Because light-absorbing materials have the physical property of converting incident light into heat, damage can arise to heat-sensitive or flammable light-absorbing materials. To avoid such thermal damage and the potential danger of fire or burns, please obey the following instructions:

WARNING





- **Never cover up the light guide socket or light guide exit.**
 - Danger of fire.
- **Never cover up the open light guide socket or light guide connector exit with your hands or other parts of the body.**
 - Danger of burns.

CAUTION

- **Do not look at the LED light directly.**
LG-LSLED-RM is classified as Risk Group 2 regulated by IEC62471 "Photobiological Safety of Lamps and Lamp Systems".
Possibly hazardous optical radiation emitted from this product.
Do not stare at operating lamp. May be harmful to eyes.



Safety warning symbols

The following symbols are placed on the product.
Study the meaning of the symbols and always use the product in the safest possible manner.

Symbol	Meaning
	Indicates a non-specific general hazard. Follow the description given after this symbol or in the instruction manual.
	Indicates that the surface becomes hot. Be careful, it may cause burns.
	Indicates that the seesaw type main switch is ON. (Seesaw type is the type of switch where ON or OFF is selected by pressing it to ON or OFF side.)
	Indicates that the seesaw type main switch is OFF.

Label position and instruction

The labels are attached to the portions which require special cautions during use and operation.
Be sure to follow these instructions.

Label position	Label	Instructions in instruction manual	Page
Back of LG-LSLED-RVI		Caution for electric safety	4
Front of LG-LSLED-RVI		Warning and caution for LED	4
		High temperature	4

When caution labels are dirty or peeled off, contact Evident for replacement or inquiries.

Handling Precautions

NOTE

- This product is a precision instrument. Handle it with care and avoid subjecting it to a sudden or severe impact.
- Never disassemble any part of the product. Otherwise, failure could be caused.
- Do not use the product in areas where it may be subjected to direct sunlight, high temperature and/or humidity, dust or vibrations. (For conditions of operating environments, see "5 Specifications" (P12).)
- Only the Evident industrial fiberscope or industrial rigid borescope can be combined with this product. The use of this product in combination with other separately available items not only creates the risk of abnormal operation, but it also may damage the product.

TIP

- The power cord is for exclusive use of this product. Do not use it with other product.
- Before disposing of this product, be sure to follow the regulations and rules of your local government.

1 Nomenclature of main operating portions

This section describes the nomenclature of main operating portions of the product.

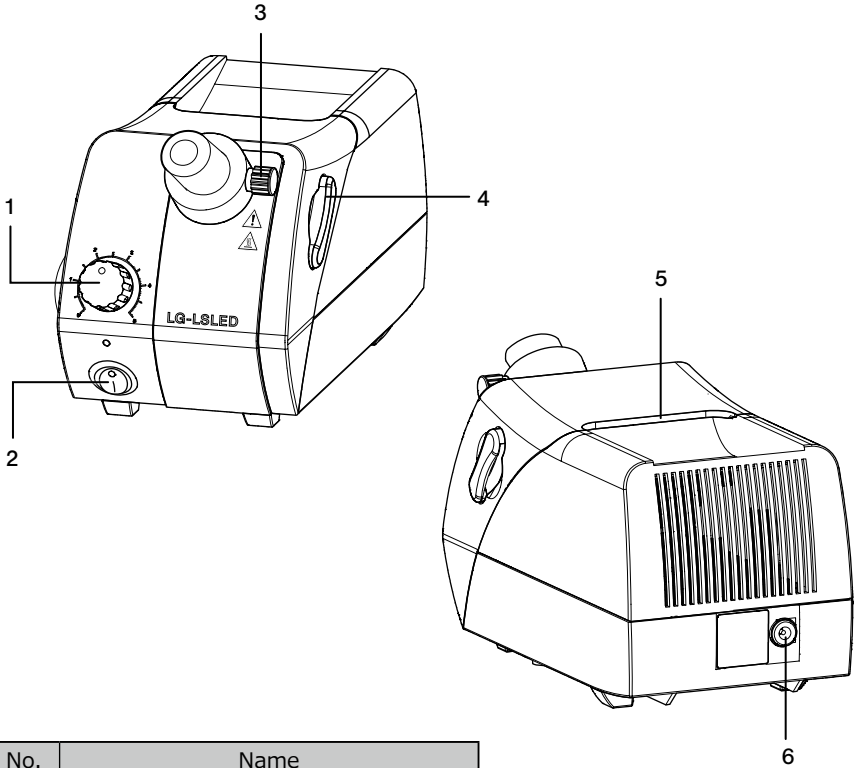

No.	Name
1	Light intensity adjustment knob (P9)
2	Main switch (P9) I(ON) / O(OFF)
3	Lock screw
4	Filter slider *Not used in combination with endoscope
5	Carrying handle
6	Power socket (P8)

2 Operating procedures

This section describes the basic operating procedures of each portion.

2-1 Connecting the AC adapter and the power cord

⚠ CAUTION

- Do Always use the AC adapter and the power cord designated by Evident. If the proper AC adapter and the power cord are not used, the electric safety and the EMC (Electromagnetic Compatibility) performance of the product cannot be assured. If no power cord is provided, please select the proper power cord by referring to the section "Proper selection of the power cord" at the end of this instruction manual.
- If you use the power plug, it into 3-core outlets with grounds. If the outlet is not grounded, the electric safety performance intended by Evident cannot be assured.

NOTE

- Do not apply excess force to the power cord or the AC adapter cord.
- Before connecting the power cord to the AC adapter, be sure to set the main switch to **○(OFF)**.

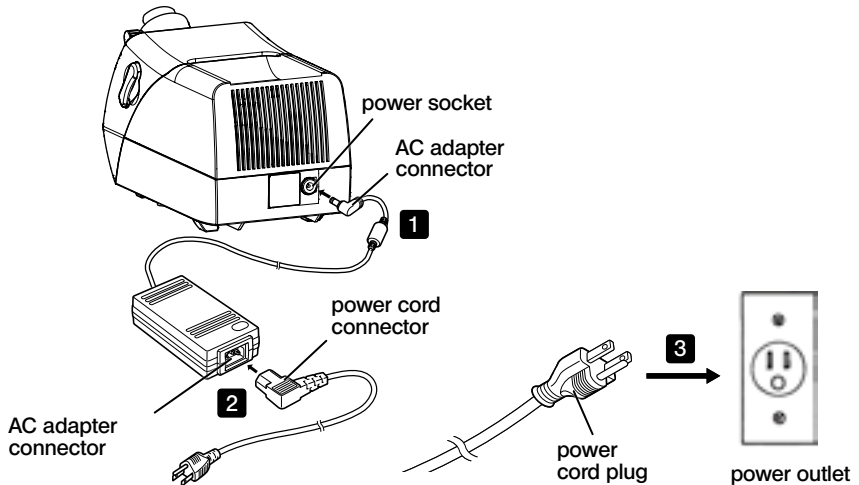

- 1** Connect the provided AC adapter connector to the power socket of LG-LSLED-RV1.
- 2** Connect the specified power cord connector to the AC adapter connector.
- 3** Connect the power cord plug to the power outlet.

2-2 Turning ON the main switch and adjusting the brightness

⚠ WARNING

Before turning on the main switch, please confirm that the cap at the end of the scope is disconnected.

As the cap absorbs the light, heat damage, fire or burns may be caused.

⚠ CAUTION

Be sure to set the scale of the light intensity adjustment knob to 0 before turning on the main switch.

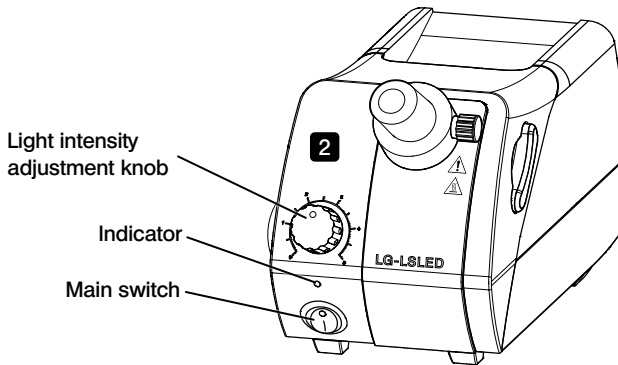

1 Set the main switch to **I** (ON).

2 Rotate the light intensity adjustment knob toward the scale 5 (arrow direction) to increase the brightness or rotate it toward the scale 0 to decrease the brightness.

NOTE

If you set the light intensity level to scale 0, the light is not emitted, but the power of the LG-LSLED-RVI is ON (The indicator is ON). To turn OFF the power, set the main switch to **O** (OFF).

3 Troubleshooting

This section describes the possible problems of this product and their remedies.

If problems occur, please review the following list and take remedial action as needed. If you cannot solve the problem after checking the entire list, please contact Evident for assistance.

Problem	Cause and recommended action
A light is not emitted.	The AC adapter is not connected. →Connect the outlet plug to the AC adapter properly. →Make sure that the outlet plug is connected to the commercial power supply and the DC power jack is connected to the LG-LSLED-RVI properly.
	The power is not supplied to the AC adapter. →Check the commercial power supply.
	The power is not ON. →Turn ON the main switch.
	The light guide connector is disconnected. →Connect the light guide connector to the LG-LSLED-RVI (LED light source unit) properly.
	The distal end of the scope is covered by the cap. →Remove the cap.
The light intensity is reduced.	The light source unit is overheated. →Make sure that the cooling fan is working properly. →Make sure that air vents or exhaust ports are not covered by obstacles.
	The light guide connector is about to be disconnected. →Connect the light guide connector to the LG-LSLED-RVI (LED light source unit) properly.
	The filter slider is not inserted completely to the end. →Make sure that the filter slider is inserted completely to the end.
	The tip of light guide connector is dirty. →Remove the dust/dirt.

Repair request

If you cannot solve the problems even though taking actions described in Troubleshooting, please contact Evident for assistance. At that time, please tell them the following information as well.

- Product name and abbreviation (Example: LED light source unit LG-LSLED-RVI)
- Product number
- Problem

4 Maintenance and storage

This section describes how to maintain and store this product.

Cleaning of each unit

Do not leave stains or fingerprints on the lenses. If they get dirty, blow away dust with a commercially available blower and gently wipe the lens or filter with a piece of cleaning paper (or clean gauze).

Only when cleaning fingerprints and oil stains, slightly moisten a piece of cleaning paper with commercially available absolute alcohol and wipe them off with it.

WARNING

Since the absolute alcohol is highly flammable, it must be handled carefully. Be sure to keep it away from open flames or potential sources of electrical sparks. For example, the electrical equipment that is switched ON and OFF may cause the ignition of a fire. Also, always use absolute alcohol only in a well-ventilated room.

Wipe the portions other than the lens with a dry soft cloth. If the dirt cannot be removed by dry-wiping, moisten a soft cloth with diluted neutral detergent and wipe the dirty surface with it.

NOTE

Do not use organic solvents because they may deteriorate the coated surface or plastic parts.

As the cooling fan is used with this product, the dust may pile up when using the product for a long time. Clean the product on a regular basis.

5 Specifications

This section describes detail specifications, such as shape, functions and performances, etc. of this product.

■ LG-LSLED-RVI (Light source unit)

Item	Specifications
Power supply	Use AC adapter. Input voltage range: AC 100-240 V 50-60 Hz Input current: Max: 1.4 A Output voltage: DC 24 V Output current: 2.71 A Power consumption: 65 W Dimension: 115 (L) x 53 (W) x 38(H) mm Weight: 310 g (reference value)
Rating	Rated input voltage: DC 24 V 1.5A Power consumption: Max: 37 W
Illumination light source	Lifetime of LED Color: White Design value: Approx. 60,000 hours (Value derived by calculating the LED element alone based on LM80/TM21)
Light intensity adjustment	Continuous variable knob Scale: 0 (turned OFF) to 5)
Available scopes	Our Industrial Fiberscope, Industrial Rigid Mirror
Dimension	114 (W) x 231 (D) x 137 (H) mm
Weight	Approx. 245 kg
Operating environment	<ul style="list-style-type: none"> • Indoor use • Altitude: Max. 2000 meters • Ambient temperature: 5 to 40 °C (41 to 104 °F) • Relative humidity: Max 80% (31 °C (88 °F) or less) (without condensation) In case of over 31 °C (88 °F), the relative humidity in operating environment is decreased linearly through 70% at 34 °C (93 °F), 60% at 37 °C (99 °F), and to 50% at 40 °C (104 °F). • Supply voltage fluctuation: ±10 % • Pollution degree 2 (in accordance with IEC60664-1) • Installation/Overvoltage category: II (in accordance with IEC60664-1)
Cooling method	Air cooling (low noise)

Proper selection of the power supply cord

If no power supply cord is provided, please select the proper power supply cord for the equipment by referring to "Specifications" and "Certified Cord" below:

Caution : In case you use a non-approved power supply cord for Evident products, Evident can no longer warrant the electrical safety of the equipment.

Specifications

Voltage rating Current rating Temperature rating Length Fittings configuration	125 V AC (for 100-120 V AC area) or, 250 V AC (for 220-240 V AC area) 6 A minimum *60 °C minimum 3.05 m maximum Grounding type attachment plug cap. Opposite terminates in molded-on IEC configuration appliance coupling.
--	--

Table 1 Certified cord

A power supply cord should be certified by one of the agencies listed in Table 1, or comprised of cordage marked with an agency marking per Table 1 or marked per Table 2. The fittings are to be marked with at least one of the agencies listed in Table 1. In case you are unable to buy locally the power supply cord which is approved by one of the agencies mentioned in Table 1, please use replacements approved by any other equivalent and authorized agencies in your country.



















Country	Agency	Certification mark	Country	Agency	Certification mark
Argentina	IRAM		Italy	IMQ	
Australia	SAA		Japan	JET	
Austria	ÖVE		Netherlands	KEMA	
Belgium	CEBEC		Norway	NEMKO	
Canada	CSA		Spain	AEE	
Denmark	DEMKO		Sweden	SEMKO	
Finland	FEI		Switzerland	SEV	
France	UTE		United Kingdom	ASTA BSI	
Germany	VDE		USA	UL	
Ireland	NSAI				

Table 2 HAR flexible cord

Approval organizations and cordage harmonization marking methods

Approval organization	Printed or embossed harmonization marking (May be located on jacket or insulation of internal wiring)	Alternative marking utilizing black-red-yellow thread (Length of color section in mm)		
		Black	Red	Yellow
Comite Electrotechnique Belge (CEBEC)	CEBEC <HAR>	10	30	10
Verband Deutscher Elektrotechniker (VDE) e.V. Prüfstelle	<VDE> <HAR>	30	10	10
Union Technique de l'Electricite' (UTE)	USE <HAR>	30	10	30
Istituto Italiano del Marchio di Qualita' (IMQ)	IEMMEQU <HAR>	10	30	50
British Approvals Service for Electric Cables (BASEC)	BASEC <HAR>	10	10	30
N.V. KEMA	KEMA-KEUR <HAR>	10	30	30
SEMKO AB Svenska Elektriska Materielkontrollanstalter	SEMKO <HAR>	10	10	50
Österreichischer Verband für Elektrotechnik (ÖVE)	<ÖVE> <HAR>	30	10	50
Danmarks Elektriske Materialkontroll (DEMKO)	<DEMKO> <HAR>	30	10	30
National Standards Authority of Ireland (NSAI)	<NSAI> <HAR>	30	30	50
Norges Elektriske Materielkontroll (NEMKO)	NEMKO <HAR>	10	10	70
Asociacion Electrotecnica Y Electronica Espanola (AEE)	<UNED> <HAR>	30	10	70
Hellenic Organization for Standardization (ELOT)	ELOT <HAR>	30	30	70
Instituto Portages da Qualidade (IPQ)	np <HAR>	10	10	90
Schweizerischer Elektro Technischer Verein (SEV)	SEV <HAR>	10	30	90
Elektriska Inspektoratet	SETI <HAR>	10	30	90

Underwriters Laboratories Inc. (UL)
Canadian Standards Association (CSA)

SV, SVT, SJ or SJT, 3 X 18AWG
SV, SVT, SJ or SJT, 3 X 18AWG