

**INSTRUCTIONS**  
**INDUSTRIAL RETRIEVAL TOOL**

**MAJ-1353**

**MAJ-1354**

**MAJ-1355**

**MAJ-1356**

**MAJ-1357**

# Contents

## **Important Information— Please Read Before Use<sup>1</sup>**

Intended use .....	1
Instruction manual .....	1
Combined ancillary equipment .....	1
Repair and modification .....	1
Signal words .....	2
Dangers, warnings and cautions .....	2

## **Chapter 1 Checking the Package Contents ..... 4**

## **Chapter 2 Instrument Nomenclature and Specifications ..... 5**

2.1 Nomenclature .....	5
------------------------	---

## **Chapter 3 Operation ..... 8**

3.1 Inspection of external appearance .....	8
3.2 Inspection of functions .....	9
3.3 Insertion into channel port of scope unit .....	11
3.4 Withdrawal from scope unit .....	17
3.5 Using the industrial retrieval tool .....	19

## **Chapter 4 Care and Maintenance ..... 22**

## **Chapter 5 Specifications ..... 23**

# ***Important Information— Please Read Before Use***

## ***Intended use***

This instrument has been designed to be used in combination with EVIDENT IV7635X1 or IV8635X1 industrial videoscope unit for use in retrieval of foreign objects from the inside of a machine, equipment or construction that cannot be viewed directly from the outside. This instrument should not be used for any purpose other than their intended use. In particular, it should never be used inside the body cavities of humans and animals.

## ***Instruction manual***

This instruction manual contains essential information on using the instrument safely and effectively. Before use, thoroughly review this manual and the manuals of the equipment which will be used together with this instrument and use all of the equipment as instructed.

Keep this and all related instruction manuals in a safe, accessible location. If you have any questions or comments about any information in this manual, please contact EVIDENT.

## ***Combined ancillary equipment***

This instrument should be used only in combination with EVIDENT IV7635X1 or IV8635X1 industrial videoscope unit.

If it is used in combination with equipment other than EVIDENT IV7635X1 and IV8635X1 industrial videoscope unit, malfunction or equipment damage may result.

## ***Repair and modification***

This instrument should never be disassembled or modified. It does not contain any user-serviceable parts. Do not disassemble, modify or attempt to repair. User injury, equipment damage and/or functional failure can result.

## ***Signal words***

The following signal words are used throughout this manual.

### **DANGER**

Indicates an imminently hazardous situation which, if not avoided, will result in death or serious injury.

### **WARNING**

Indicates a potentially hazardous situation which, if not avoided, could result in death or serious injury.

### **CAUTION**

Indicates a potentially hazardous situation which, if not avoided, may result in minor or moderate injury. It may also be used to alert against unsafe practices or potential equipment damage.

### **NOTE**

Indicates additional helpful information.

## ***Dangers, warnings and cautions***

Follow the dangers, warnings and cautions given below when handling this instrument. Please also be sure to read and follow the dangers, warnings and cautions given in individual chapters.

### **DANGER**

Never use this instrument inside the body cavities of humans and animals. This could cause injury.

### **WARNING**

- Handle the retrieval carefully so as not to hurt your eye with the distal end.

- After using the industrial retrieval tool, be sure to confirm that none of its parts is dropped.  
If any of parts drops inside the machine, a serious accident could result.
- If the foreign object retrieval section of the industrial retrieval tool is caught inside the subject, do not withdraw the industrial retrieval tool by force. Otherwise, the industrial retrieval tool may be damaged or dropped.
- Do not manipulate the handle with an excessive force when holding a foreign object. Otherwise, damage to the handle, damage to the industrial retrieval tool or dropping of the industrial retrieval tool may result.

### **CAUTION**

- Do not insert the industrial retrieval tool in a machine that is running. Otherwise, the industrial retrieval tool may be damaged.
- Do not use the industrial retrieval tool in an environment containing small particulates such as metal dust. Otherwise, the scope or industrial retrieval tool may be damaged.
- The IV7635X1 used in combination with this instrument is not designed waterproof. Do not use the IV7635X1 and IV8635X1 in an environment in which the industrial retrieval tool may be moistened by a liquid. Otherwise, the scope may be damaged.
- Even under normal use of the industrial retrieval tool, its foreign object retrieval section may be deformed permanently and unable to be used continuously. In such a case, replace the industrial retrieval tool with a new one.
- Looping the industrial retrieval tool or the scope unit containing the industrial retrieval tool results in increasing the force required to manipulate the control section. Do not manipulate the control section by force in case of difficulty in manipulation. Otherwise, the industrial retrieval tool may be damaged.

# Chapter 1 Checking the Package Contents

Match all items in the package with the components shown below. Inspect each item for damage. If any item is missing or damaged or you have any question, do not use the instrument; immediately contact EVIDENT.

## MAJ-1353 Snare / MAJ-1355 Basket / MAJ-1356 Grasper

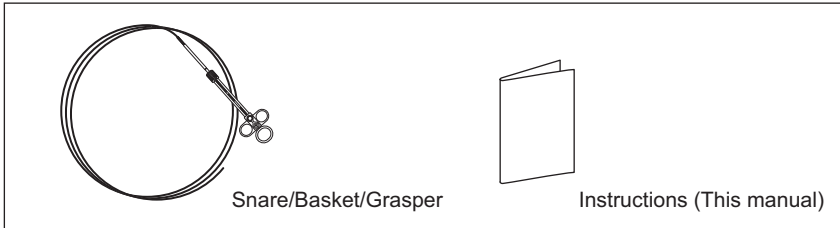

## MAJ-1354 Alligator

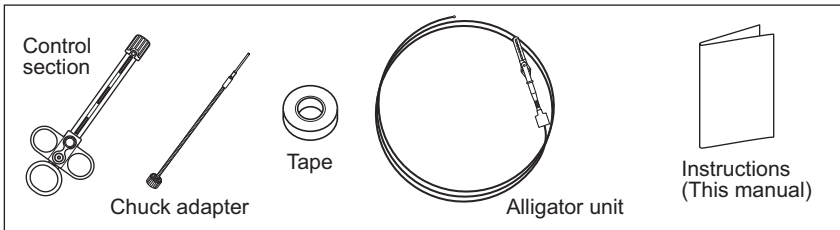

## MAJ-1357 Magnet

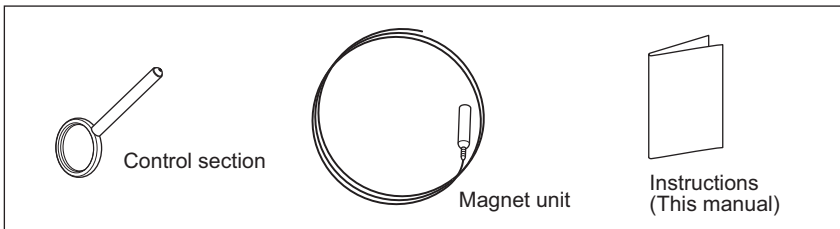

# Chapter 2 Instrument Nomenclature and Specifications

## 2.1 Nomenclature

MAJ-1353 Snare / MAJ-1355 Basket / MAJ-1356 Grasper

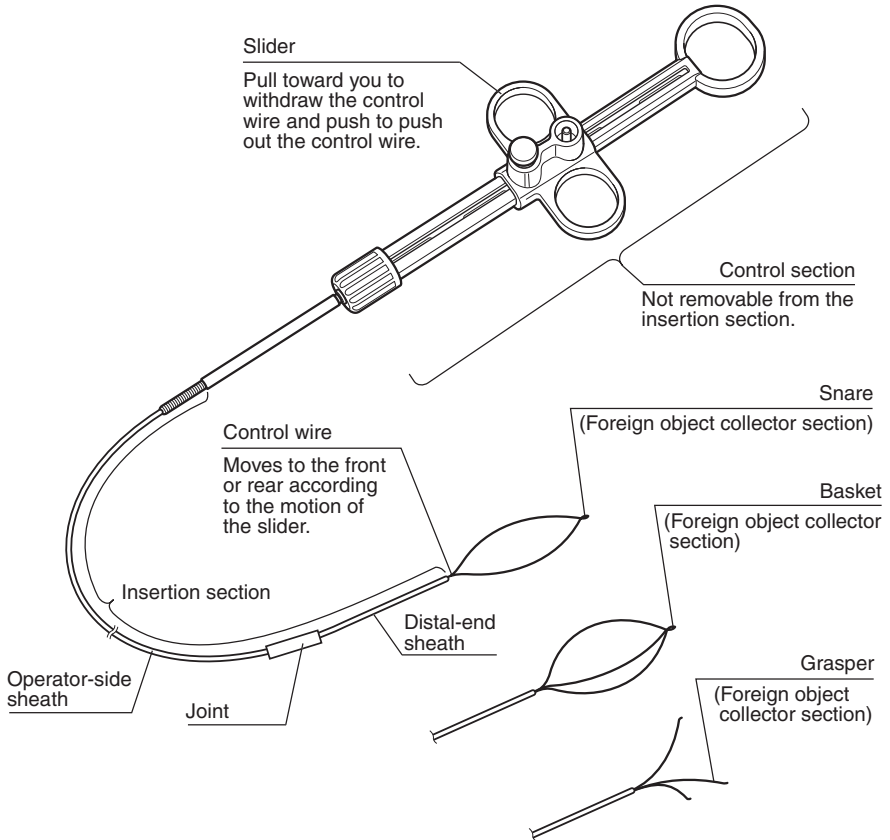

## MAJ-1354 Alligator

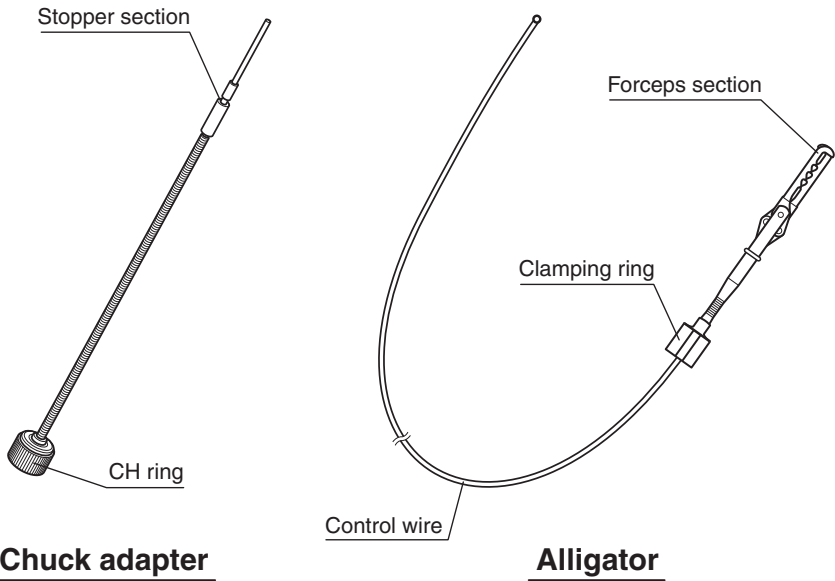
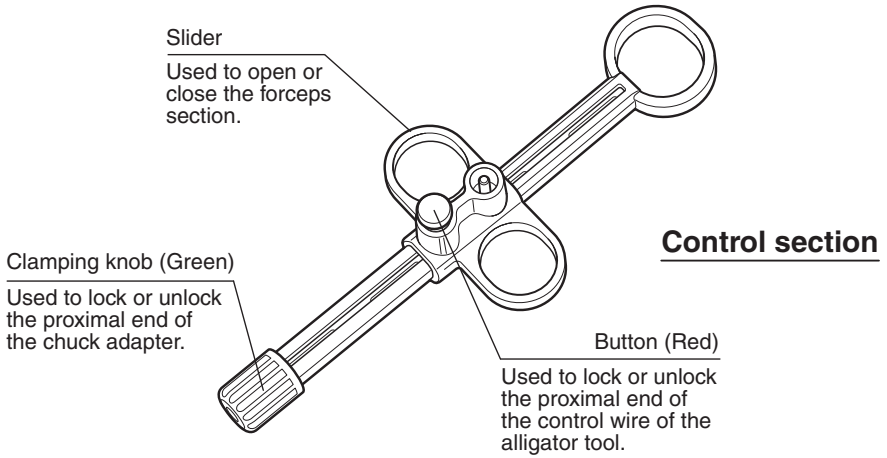



## MAJ-1357 Magnet

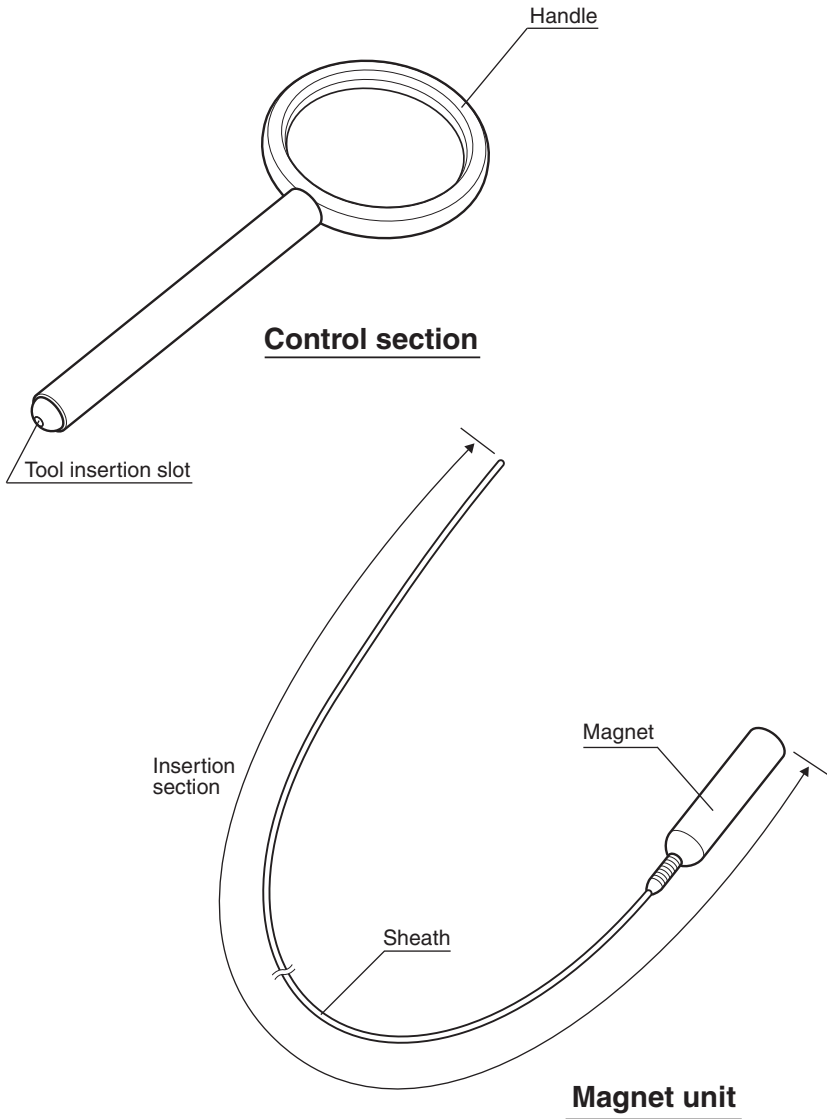

# Chapter 3 Operation

## **WARNING**

- Be sure to finish the preparation and inspection work described below before use. Also inspect the ancillary equipment used in combination with this instrument according to the indications in its instruction manual.  
If any irregularity is suspected, do not use the instrument but contact EVIDENT. Using the industrial retrieval tool while irregularity is suspected may result in damage to the subject or dropping of the distal end of the industrial retrieval tool.
- Handle the retrieval carefully so as not to hurt your eye with the distal end.

## **CAUTION**

- Even under normal use of the industrial retrieval tool, its foreign object retrieval section may be deformed permanently and unable to be used continuously. In such a case, replace the industrial retrieval tool with a new one.
- Looping the industrial retrieval tool or the scope unit containing the industrial retrieval tool results in increasing the force required to manipulate the control section. Do not manipulate the control section by force in case of difficulty in manipulation. Otherwise, the industrial retrieval tool may be damaged.

## **3.1 Inspection of external appearance**

1. Pinch the insertion section lightly with your fingers, run them along the full length of the insertion section and confirm that the insertion section is not crushed or bent excessively and that the sheath is not damaged.
2. Confirm that the distal end of the sheath does not contain excessive deformation, sharp edges or burrs.
3. Confirm that the foreign object retrieval section of the industrial retrieval tool does not contain frayed spots, wire disconnection or deformation.
4. Confirm that the control section is not cracked.

## 3.2 Inspection of functions

### Snare, basket or grasper

1. Move the slider to the front and rear and confirm that the foreign object retrieval section of the industrial retrieval tool can be opened smoothly and securely to the desired shape and closed (see Figure 3.1).

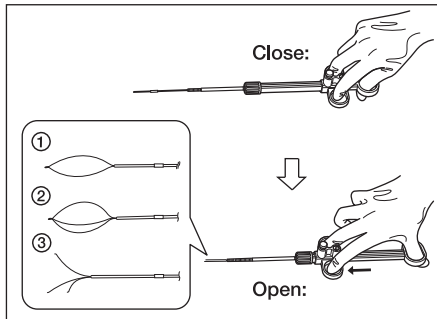

Figure 3.1

2. Pull the distal end of the industrial retrieval tool with a light force and confirm that it does not slip out easily (see Figure 3.2).

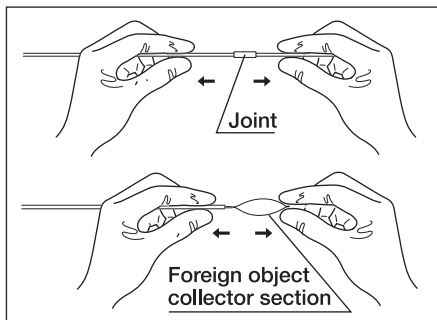

Figure 3.2

3. Pull the slider and confirm that the distal end of the industrial retrieval tool is withdrawn inside the sheath.

## Alligator

1. Pinch the clamping ring at the distal end of the alligator unit with your fingers, move the control wire to the front and rear and confirm that the forceps section opens and closes (see Figure 3.3).

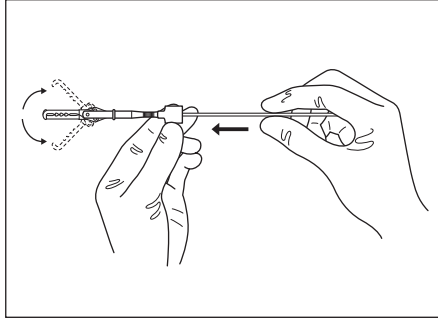

Figure 3.3

2. Pull the distal end of the alligator unit with a light force and confirm that it is attached firmly (see Figure 3.4).

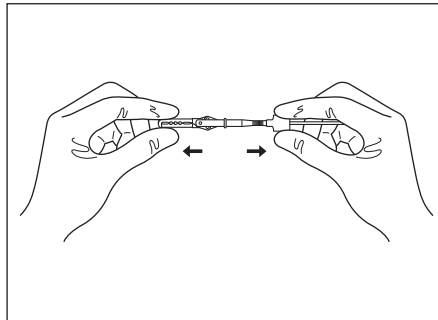

Figure 3.4

## Magnet

1. Pull the distal end of the magnet unit with a light force and confirm that it is attached firmly.

### 3.3 Insertion into channel port of scope unit

#### CAUTION

- Extend the insertion tube of the scope unit straight and insert the industrial retrieval tool into the channel port. Do not insert the industrial retrieval tool while the insertion tube is looped, as this may damage the channel tube inside the scope of the scope unit.
- When the industrial retrieval tool is stopped during insertion, do not continue insertion by force, but withdraw it temporarily and then try insertion again. Insertion by force may result in damaging the industrial retrieval tool or scope.
- Confirm that the optical adapter is attached to the distal end of the scope unit before inserting the industrial retrieval tool. If you attempt to attach the optical adapter after inserting the industrial retrieval tool, the industrial retrieval tool or optical adapter may be damaged.
- The industrial retrieval tool is usable only when a direct-view adapter is attached to the scope unit. If the industrial retrieval tool is inserted while a side-view adapter is attached to the scope unit, the industrial retrieval tool may be damaged.

#### Snare, basket or grasper

#### CAUTION

- Accommodate the foreign object retrieval section of the industrial retrieval tool into its sheath and insert the industrial retrieval tool into the channel port of the scope unit. If the industrial retrieval tool is inserted while the foreign object retrieval section is projected, the industrial retrieval tool or the channel tube inside the scope unit may be damaged.
- Do not insert the industrial retrieval tool into the channel port of the scope unit while the scope unit is inserted into the subject. Otherwise, the industrial retrieval tool or the channel port inside the scope unit may be damaged.

1. **IV7635X1:**

Turn the hook lock assembly retaining screw on the channel port of the scope unit to detach the hook lock assembly from the scope unit.

**IV8635X1:**

Loosen the chuck screw of the channel port.

2. Extend the insertion tube of the scope unit almost straight.
3. Extend the insertion section of the industrial retrieval tool almost straight.
4. Pull the slider of the control section toward you to accommodate the foreign object retrieval section of the industrial retrieval tool inside its sheath.
5. Insert the insertion section of the industrial retrieval tool into the channel port (see Figure 3.5).

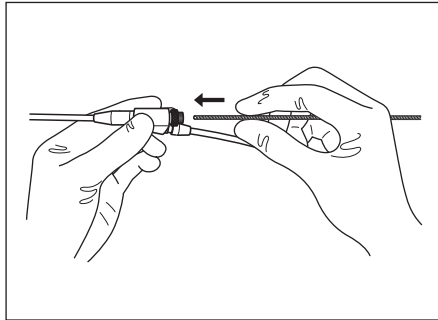

Figure 3.5

## Alligator

1. **IV7635X1:**

Hook lock assembly is detached from channel port of the scope unit.

**IV8635X1:**

Port cap is detached from channel port of the scope unit.

2. Align the projection on the chuck adapter with the notch on the channel port, and tighten the CH ring to clamp the chuck adapter in position (see Figure 3.6).

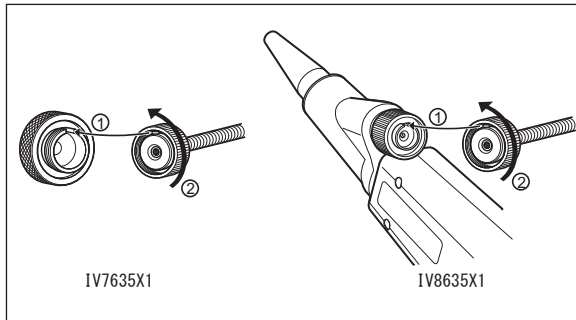

Figure 3.6

3. Extend the insertion tube of the scope unit almost straight.
4. Extend the control wire of the alligator unit almost straight.
5. Hold the scope unit by an area close to its distal end, slowly insert the proximal end of the control wire of the alligator unit into the channel at the distal end of the scope unit, and confirm that the proximal end of the control wire comes smoothly out of the chuck adapter.
6. Insert the alligator unit so that the stopper on the clamping ring at its distal end hits the optical adapter at the distal end of the scope, and fix the clamping ring and the distal end of the insertion section using a piece of tape (see Figure 3.7).

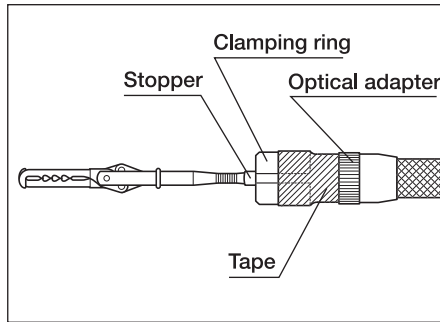

Figure 3.7

7. While depressing the slider's button (red), insert the proximal end of the control wire all the way into the distal end of the control section of industrial retrieval tool, and then release the button (red) to fix the control wire on the control section (see Figure 3.8).

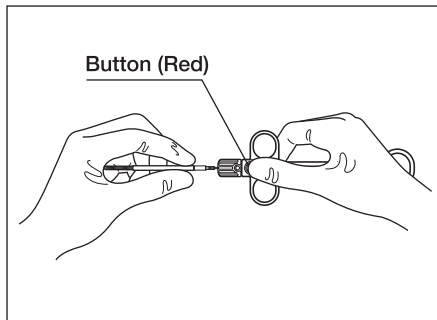

Figure 3.8

8. Pull the control wire of the alligator unit with a light force and confirm that the control wire is fixed firmly.



9. Turn the clamping knob (green) at the distal end of the control section clockwise and confirm that a red marking is visible through the notch on the clamping knob (see Figure 3.9).

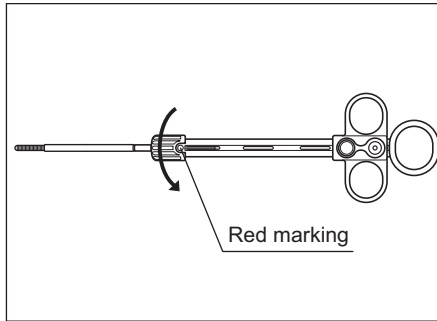

Figure 3.9

10. Insert the distal end of the chuck adapter all the way into the distal end of the control section, and then turn the clamping knob (green) counterclockwise until it clicks to lock the chuck adapter (see Figure 3.10).

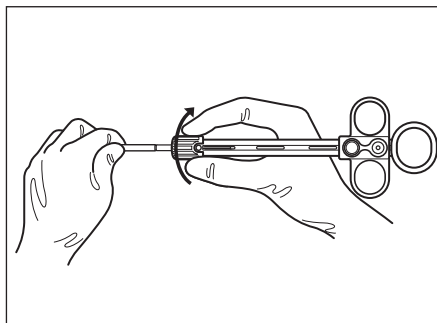

Figure 3.10

11. Pull the chuck adapter with a light force and confirm that it is locked firmly.
12. Move the slider to the front and rear and confirm that the forceps section opens and closes (see Figure 3.11).

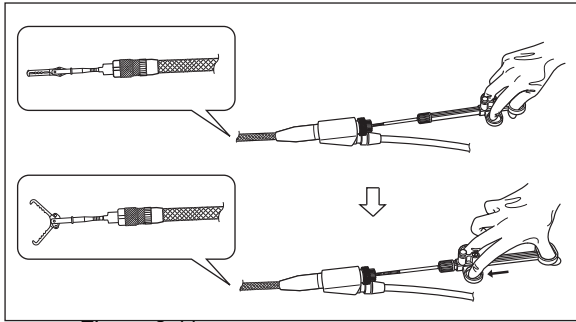

Figure 3.11

## Magnet

1. Turn the hook lock assembly retaining screw on the channel port of the scope unit to detach the hook lock assembly from the scope unit.
2. Extend the insertion tube of the scope unit almost straight.
3. Extend the sheath of the magnet unit almost straight.
4. Hold the scope unit by an area close to its distal end, slowly insert the proximal end of the magnet unit into the channel at the distal end of the scope unit, and confirm that the proximal end of the magnet unit comes smoothly out of the chuck adapter.
5. Screw, by turning clockwise, the proximal end of the magnet unit into the tool inlet at the distal end of the magnet control section. (see Figure 3.12)

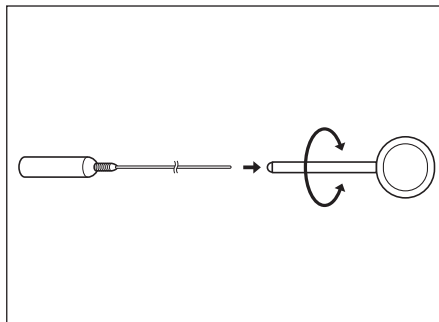

Figure 3.12

6. Confirm that the distal end of the magnet tool moves to the front and rear according to manipulation of the control section of the magnet tool.

## 3.4 Withdrawal from scope unit

### WARNING

- Be sure to withdraw the scope from the subject before withdrawing the industrial retrieval tool from it. If the industrial retrieval tool is withdrawn while the scope is inserted into the subject, the industrial retrieval tool would be stopped inside the channel of the scope unit, resulting in damage to or dropping of the foreign object retrieval section.
- Confirm that no foreign object is caught by the distal end of the industrial retrieval tool before withdrawing it from the scope. If the industrial retrieval tool is withdrawn while its distal end holds a foreign object, the foreign object retrieval section may be damaged or dropped.
- After use, confirm that none of the industrial retrieval tool parts is dropped.  
If a part drops inside the machine, a serious accident may result.

### Snare, basket or grasper

### CAUTION

Accommodate the distal end of the industrial retrieval tool inside the sheath before withdrawing the industrial retrieval tool from the scope unit.

If the industrial retrieval tool is withdrawn while the foreign object retrieval section is projected, the industrial retrieval tool or scope unit may be damaged.

1. Pull the slider towards you to withdraw the foreign object retrieval section inside the sheath (see Figure 3.13).

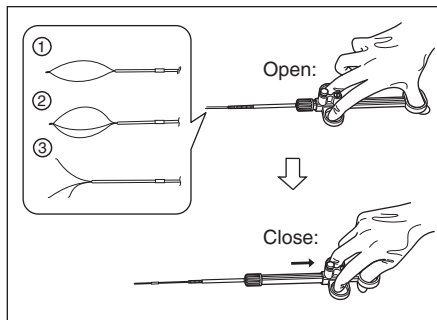

Figure 3.13

2. Extend the insertion tube of the scope almost straight, and withdraw the industrial retrieval tool from the channel port.

## Alligator

1. Turn the clamping knob (green) at the distal end of the control section clockwise and withdraw the distal end of the chuck adapter (see Figure 3.14).

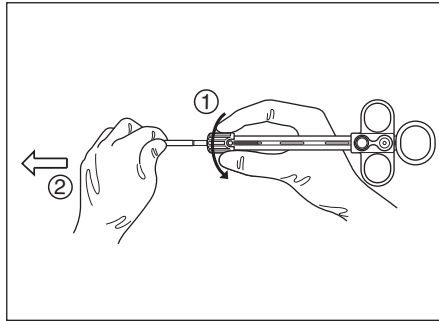

Figure 3.14

2. While depressing the slider's button (red) of the slider, pull the control wire and detach the control section (see Figure 3.15).

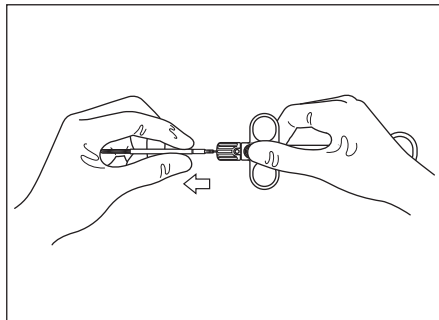

Figure 3.15

3. Remove the tape fixing the clamping ring at the distal end of the alligator tool on the distal end of the scope unit, extend the scope almost straight and withdraw the alligator unit from the distal end of the scope.

## Magnet

1. Turn the control section counterclockwise to remove it from the sheath of the magnet unit.
2. Extend the insertion tube of the scope unit almost straight, and then withdraw the magnet unit from the distal end of the scope unit.

## 3.5 Using the industrial retrieval tool

### **WARNING**

- If the foreign object retrieval section of the industrial retrieval tool is caught inside the subject, do not withdraw the industrial retrieval tool by force. Otherwise, the industrial retrieval tool may be damaged or dropped.
- Do not manipulate the handle with an excessive force when holding a foreign object. Otherwise, damage to the handle, damage to the industrial retrieval tool or dropping of the industrial retrieval tool may result.
- Do not attempt to hold and retrieve a foreign object that is larger than the inlet of the scope. Otherwise, the foreign object may be stopped at the scope's inlet and the foreign object or the foreign object retrieval section of the industrial retrieval tool may drop.

## Snare, basket or grasper

1. Push the slide to push the control wire out of the sheath and open the foreign object retrieval section of the industrial retrieval tool so that it can hold the foreign object (see Figure 3.16).

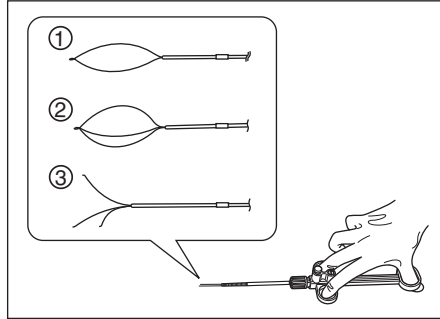

Figure 3.16

2. When the slider is pulled toward you, the control wire is withdrawn inside the sheath and the foreign object retrieval section of the retrieval closes to hold the foreign object (see Figure 3.17).

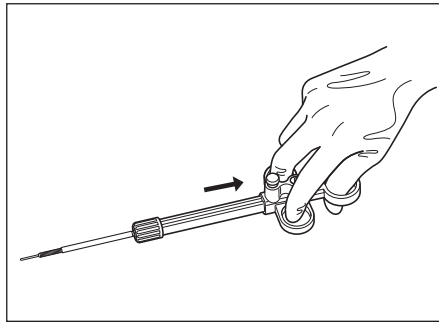

Figure 3.17

3. With the control wire pulled toward you, withdraw the scope from the subject to take out the foreign object.

## Alligator

1. Push the slider to open the forceps section so that it gets ready to hold the foreign object (see Figure 3.18).

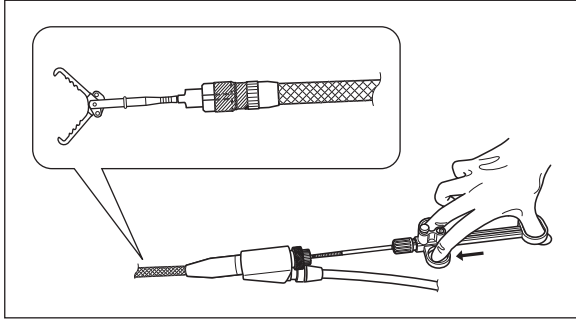

Figure 3.18

2. Pull the slider to close the forceps section so that it actually holds the foreign object (see Figure 3.19).

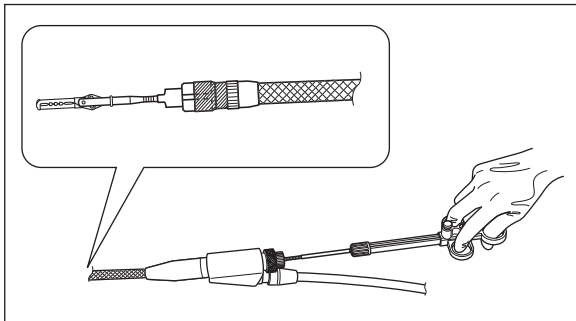

Figure 3.19

## Magnet

The magnet tool is used to retrieve a foreign object that is made of a magnetic material.

# Chapter 4 Care and Maintenance

## **CAUTION**

- When storing the industrial retrieval tool by rolling it, roll it so that the curvature radius is more than 100 mm. To prevent permanent deformation, do not roll it to too small a radius.
  - Do not store the industrial retrieval tool (snare, basket or grasper) while its foreign object retrieval section is projected. Otherwise, the industrial retrieval tool may be damaged.
  - Store the industrial retrieval tool under normal room temperature and humidity conditions. Make sure it is kept in good condition. Avoid areas that are subject to direct sunlight or radioactive rays.
1. Make sure that the industrial retrieval tool is not stained with soil or oil. If it is contaminated, wash the contamination with a solution of neutral detergent, etc., rinse well and dry it completely.
  2. Store the retrieval in the provided bubble bag.



# Chapter 5 Specifications

## Operating environment

- Operating temperatures: -10 to +40 C
- Operating atmospheric pressure: Normal (1013 hPa)
- Relative humidity: 15% to 90% (Noncondensing)
- Liquid resistance: No liquid is allowed to be attached.

## Other specifications

	MAJ-1353	MAJ-1355	MAJ-1356	MAJ-1354	MAJ-1357
Retrieval section at distal end	Snare	Basket	Grasper	Alligator	Magnet
Max. projection from scope unit	175±30			-	175±40
Max. sheath diameter	ø1.45			-	-
Min. diameter when attached to scope unit	-	-	-	ø9	ø8

[mm]

---

Manufactured by

**EVIDENT CORPORATION**

6666 Inatomi, Tatsuno-machi, Kamiina-gun, Nagano 399-0495, Japan

---

Distributed by

**EVIDENT EUROPE GmbH**

Caffamacherreihe 8-10, 20355 Hamburg, Germany

**EVIDENT EUROPE GmbH UK Branch**

Part 2nd Floor Part A, Endeavour House, Coopers End Road, Stansted CM24 1AL, U.K.

**EVIDENT SCIENTIFIC, INC.**

48 Woerd Ave Waltham, MA 02453, U.S.A.

**EVIDENT AUSTRALIA PTY LTD**

97 Waterloo Road, Macquarie Park, NSW 2113, Australia

---

Life science solutions

---

Service Center



[https://www.olympus-lifescience.com/  
support/service/](https://www.olympus-lifescience.com/support/service/)

Official website



<https://www.olympus-lifescience.com>

---

Industrial solutions

---

Service Center



[https://www.olympus-ims.com/  
service-and-support/service-centers/](https://www.olympus-ims.com/service-and-support/service-centers/)

Official website



<https://www.olympus-ims.com>