



27MG

Ultrasonic Thickness Gauge

User's Manual

DMTA-10043-01EN — Revision E
September 2022

This instruction manual contains essential information on how to use this Evident product safely and effectively. Before using this product, thoroughly review this instruction manual. Use the product as instructed. Keep this instruction manual in a safe, accessible location.

EVIDENT SCIENTIFIC INC., 48 Woerd Avenue, Waltham, MA 02453, USA

Copyright © 2022 by Evident. All rights reserved. No part of this publication may be reproduced, translated, or distributed without the express written permission of Evident.

This document was prepared with particular attention to usage to ensure the accuracy of the information contained therein, and corresponds to the version of the product manufactured prior to the date appearing on the title page. There could, however, be some differences between the manual and the product if the product was modified thereafter.

The information contained in this document is subject to change without notice.

Part number: DMTA-10043-01EN

Revision E

September 2022

Printed in the United States of America

All brands are trademarks or registered trademarks of their respective owners and third party entities.

Table of Contents

List of Abbreviations	7
Important Information – Please Read Before Use	9
Intended Use	9
Instruction Manual	9
Device Compatibility	10
Repair and Modification	10
Safety Symbols	10
Safety Signal Words	11
Note Signal Words	12
Safety	12
Warnings	12
Battery Precautions	13
Regulations for Shipping Products with Lithium-Ion Batteries	15
Equipment Disposal	15
BC (Battery Charger - California, USA Community)	15
CE (European Community)	16
UKCA (United Kingdom)	16
RCM (Australia)	16
WEEE Directive	16
China RoHS	17
Korea Communications Commission (KCC)	18
EMC Directive Compliance	18
FCC (USA) Compliance	19
ICES-001 (Canada) Compliance	20
Warranty Information	20
Technical Support	21
1. Instrument Description	23
1.1 Product Description	23

1.2	Environmental Ratings	24
1.3	Instrument Hardware Components	24
1.4	Connectors	25
1.5	Keypad Functions	26
2.	27MG Power Requirements	31
2.1	Power Indicator	31
2.2	Batteries	32
3.	Software User Interface Elements	35
3.1	Measurement Screen	35
3.2	Parameter Screens	36
4.	Initial Setup	39
5.	Standard Calibration Measurement	43
5.1	Introduction	43
5.2	Transducer Zero Compensation	44
5.3	Velocity and Zero Calibration	44
5.4	Material Velocity Calibration	45
5.5	Zero Calibration	47
6.	Measurements	49
7.	Additional 27MG Gaging Features	51
7.1	Adjusting the Backlight	52
7.2	Activating the Freeze Mode	53
7.3	Adjusting the Gain	53
7.4	Optimizing Material Gain Sensitivity	53
7.5	Restoring the Default Gain	54
7.6	Configuring the Measurement Setup	54
7.7	Configuring the System Setup	58
7.8	Activating High/Low Alarms	60
7.9	Activating Diff Mode	61
7.10	Resetting the Instrument Parameters	61
8.	Specifications	65
9.	Theory of Operation	67

10. Application Notes	69
10.1 Factors Affecting Performance and Accuracy	69
10.2 Transducer Selection	71
10.3 High Temperature Measurements	73
11. Maintenance and Troubleshooting	77
11.1 Routine Care and Maintenance	77
11.2 Transducers Maintenance	77
11.3 Error Messages	78
11.4 Battery Problems	78
11.5 Setup (Do-) Problems	78
11.6 Measurement Problems Diagnostic	78
11.7 Self Diagnostics	79
11.8 Gauge Performance Tests	81
11.9 Repair Service	83
11.10 Replacement Parts, Optional Parts, and Equipment	83
Appendix: Sound Velocities	85
List of Figures	89
List of Tables	91

List of Abbreviations

DIAG	diagnostic
DIFF	differential
EFUP	environment-friendly use period
IP	Ingress Protection
LOS	loss-of-signal
Max	maximum
Min	minimum
NiMH	nickel-metal hydride
PDF	portable document format
USB	universal serial bus

Important Information — Please Read Before Use

Intended Use

The 27MG is designed to perform nondestructive inspections on industrial and commercial materials.



WARNING

Do not use the 27MG for any purpose other than its intended use. It must never be used to inspect or examine human or animal body parts.

Instruction Manual

This instruction manual contains essential information on how to use this product safely and effectively. Before using this product, thoroughly review this instruction manual. Use the product as instructed. Keep this instruction manual in a safe, accessible location.

IMPORTANT

Some of the details of components illustrated in this manual may differ from the components installed on your device. However, the operating principles remain the same.

Device Compatibility

Only use this device with the approved ancillary equipment provided by Evident. Equipment provided by Evident and approved for use with this device is described later in this manual.



CAUTION

Always use equipment and accessories that meet Evident specifications. Using incompatible equipment could cause equipment malfunction and/or damage, or human injury.

Repair and Modification

This device does not contain any user-serviceable parts. Opening the device might void the warranty.



CAUTION

In order to prevent human injury and/or equipment damage, do not disassemble, modify, or attempt to repair the device.

Safety Symbols

The following safety symbols might appear on the device and in the instruction manual:



General warning symbol

This symbol is used to alert the user to potential hazards. All safety messages that follow this symbol shall be obeyed to avoid possible harm or material damage.



High voltage warning symbol

This symbol is used to alert the user to potential electric shock hazards greater than 1000 volts. All safety messages that follow this symbol shall be obeyed to avoid possible harm.

Safety Signal Words

The following safety symbols might appear in the documentation of the device:



DANGER

The DANGER signal word indicates an imminently hazardous situation. It calls attention to a procedure, practice, or the like, which, if not correctly performed or adhered to, will result in death or serious personal injury. Do not proceed beyond a DANGER signal word until the indicated conditions are fully understood and met.



WARNING

The WARNING signal word indicates a potentially hazardous situation. It calls attention to a procedure, practice, or the like, which, if not correctly performed or adhered to, could result in death or serious personal injury. Do not proceed beyond a WARNING signal word until the indicated conditions are fully understood and met.



CAUTION

The CAUTION signal word indicates a potentially hazardous situation. It calls attention to an operating procedure, practice, or the like, which, if not correctly performed or adhered to, may result in minor or moderate personal injury, material damage, particularly to the product, destruction of part or all of the product, or loss of data. Do not proceed beyond a CAUTION signal word until the indicated conditions are fully understood and met.

Note Signal Words

The following note signal words could appear in the documentation of the device:

IMPORTANT

The IMPORTANT signal word calls attention to a note that provides important information, or information essential to the completion of a task.

NOTE

The NOTE signal word calls attention to an operating procedure, practice, or the like, which requires special attention. A note also denotes related parenthetical information that is useful, but not imperative.

TIP

The TIP signal word calls attention to a type of note that helps you apply the techniques and procedures described in the manual to your specific needs, or provides hints on how to effectively use the capabilities of the product.

Safety

Before turning on the device, verify that the correct safety precautions have been taken (see the following warnings). In addition, note the external markings on the device, which are described under “Safety Symbols.”

Warnings



WARNING

General Warnings

- Carefully read the instructions contained in this instruction manual prior to turning on the device.
- Keep this instruction manual in a safe place for further reference.

- Follow the installation and operation procedures.
- It is imperative to respect the safety warnings on the device and in this instruction manual.
- If the equipment is used in a manner not specified by the manufacturer, the protection provided by the equipment could be impaired.
- Do not install substitute parts or perform any unauthorized modification to the device.
- Service instructions, when applicable, are for trained service personnel. To avoid the risk of electric shock, do not perform any work on the device unless qualified to do so. For any problem or question regarding this device, contact Evident or an authorized Evident representative.
- Do not touch the connectors directly by hand. Otherwise, a malfunction or electric shock may result.
- Do not allow metallic or foreign objects to enter the device through connectors or any other openings. Otherwise, a malfunction or electric shock may result.

**WARNING****Electrical Warning**

The device must only be connected to a power source corresponding to the type indicated on the rating label.

**CAUTION**

If a non-approved power supply cord not dedicated to Evident products is used, Evident will not be able to ensure the electrical safety of the equipment.

Battery Precautions**CAUTION**

- Before disposing of a battery, check your local laws, rules, and regulations, and follow them accordingly.

- Transportation of lithium-ion batteries is regulated by the United Nations under the United Nations Recommendations on the Transport of Dangerous Goods. It is expected that governments, intergovernmental organizations, and other international organizations shall conform to the principles laid down in these regulations, thus contributing to worldwide harmonization in this field. These international organizations include the International Civil Aviation organization (ICAO), the International Air Transport Association (IATA), the International Maritime Organization (IMO), the US Department of Transportation (USDOT), Transport Canada (TC), and others. Please contact the transporter and confirm current regulations before transportation of lithium-ion batteries.
- For California (USA) only:
The device may contain a CR battery. The CR battery contains perchlorate material, and special handling may be required. Refer to <http://www.dtsc.ca.gov/hazardouswaste/perchlorate>.
- Do not open, crush, or perforate batteries; doing so could cause injury.
- Do not incinerate batteries. Keep batteries away from fire and other sources of extreme heat. Exposing batteries to extreme heat (over 80 °C) could result in an explosion or personal injury.
- Do not drop, hit, or otherwise abuse a battery, as doing so could expose the cell contents, which are corrosive and explosive.
- Do not short-circuit the battery terminals. A short circuit could cause injury and severe damage to a battery making it unusable.
- Do not expose a battery to moisture or rain; doing so could cause an electric shock.
- Only use an external charger approved by Evident to charge the batteries.
- Only use batteries supplied by Evident.
- Do not store batteries that have less than 40 % remaining charge. Recharge batteries to between 40 % and 80 % capacity before storing them.
- During storage, keep the battery charge between 40 % and 80 %.
- Do not leave batteries in the 27MG unit during device storage.

Regulations for Shipping Products with Lithium-Ion Batteries

IMPORTANT

When shipping a Li-ion battery or batteries, be sure to follow all local transportation regulations.



WARNING

Damaged batteries cannot be shipped through normal routes — DO NOT ship damaged batteries to Evident. Contact your local Evident representative or material disposal professionals.

Equipment Disposal

Before disposing of the 27MG, check your local laws, rules, and regulations, and follow them accordingly.

BC (Battery Charger - California, USA Community)



The BC marking indicates that this product has been tested and complies with the Appliance Efficiency Regulations as stated in the California Code of Regulations Title 20, Sections 1601 through 1608 for Battery Charger Systems. The internal battery charger within this device has been tested and certified pursuant to the California Energy Commission's (CEC) requirements; this device is listed on the online CEC's (T20) database.

CE (European Community)



This device complies with the requirements of directive 2014/30/EU concerning electromagnetic compatibility, directive 2014/35/EU concerning low voltage, and directive 2015/863 which amends 2011/65/EU concerning restriction of hazardous substances (RoHS). The CE marking is a declaration that this product conforms to all the applicable directives of the European Community.

UKCA (United Kingdom)



This device complies with the requirements of the Electromagnetic Compatibility Regulations 2016, the Electrical Equipment (Safety) Regulations 2016, and the Restriction of the Use of Certain Hazardous Substances in Electrical and Electronic Equipment Regulations 2012. The UKCA marking indicates compliance with the above regulations.

RCM (Australia)



The regulatory compliance mark (RCM) label indicates that the product complies with all applicable standards, and has been registered with the Australian Communications and Media Authority (ACMA) for placement on the Australian market.

WEEE Directive



In accordance with European Directive 2012/19/EU on Waste Electrical and Electronic Equipment (WEEE), this symbol indicates that the product must not be disposed of as unsorted municipal waste, but should be collected separately. Refer to your local Evident distributor for return and/or collection systems available in your country.



China RoHS

China RoHS is the term used by industry generally to describe legislation implemented by the Ministry of Information Industry (MII) in the People's Republic of China for the control of pollution by electronic information products (EIP).



The China RoHS mark indicates the product's Environment-Friendly Use Period (EFUP). The EFUP is defined as the number of years for which listed controlled substances will not leak or chemically deteriorate while in the product. The EFUP for the 27MG has been determined to be 15 years.

Note: The Environment-Friendly Use Period (EFUP) is not meant to be interpreted as the period assuring functionality and product performance.



本标志是根据“电器电子产品有害物质限制使用管理办法”以及“电子电气产品有害物质限制使用标识要求”的规定，适用于在中国销售的电器电子产品上的电器电子产品有害物质使用限制标志。

电器电子产品有
害物质限制使用
标志

（注意）电器电子产品有害物质限制使用标志内的数字为在正常的使用条件下有害物质等不泄漏的期限，不是保证产品功能性能的期间。

产品中有害物质的名称及含量

部件名称		有害物质					
		铅及其化合物 (Pb)	汞及其化合物 (Hg)	镉及其化合物 (Cd)	六价铬及其化合物 (Cr(VI))	多溴联苯 (PBB)	多溴二苯醚 (PBDE)
主体	机构部件	×	○	○	○	○	○
	光学部件	×	○	○	○	○	○
	电气部件	×	○	○	○	○	○

产品中有害物质的名称及含量

部件名称	有害物质					
	铅及其化合物 (Pb)	汞及其化合物 (Hg)	镉及其化合物 (Cd)	六价铬及其化合物 (Cr(VI))	多溴联苯 (PBB)	多溴二苯醚 (PBDE)
附件	×	○	○	○	○	○
本表格依据 SJ/T 11364 的规定编制。 ○：表示该有害物质在该部件所有均质材料中的含量均在 GB/T26572 规定的限量要求以下。 ×：表示该有害物质至少在该部件的某一均质材料中的含量超出 GB/T26572 规定的限量要求。						

Korea Communications Commission (KCC)



Seller and user shall be noticed that this equipment is suitable for electromagnetic equipment for office work (class A) and it can be used outside the home. This device complies with the EMC requirements of Korea.

The MSIP code for the device is the following: MSIP-REM-OYN-27MG.

이 기기는 업무용 환경에서 사용할 목적으로 적합성평가를 받은 기기로서 가정용 환경에서 사용하는 경우 전파간섭의 우려가 있습니다.

EMC Directive Compliance

This equipment generates and uses radio-frequency energy and, if not installed and used properly (that is, in strict accordance with the manufacturer's instructions), may cause interference. The 27MG has been tested and found to comply with the limits for an industrial device in accordance with the specifications of the EMC directive.

FCC (USA) Compliance

NOTE

This product has been tested and found to comply with the limits for a Class A digital device, pursuant to Part 15 of the FCC Rules. These limits are designed to provide reasonable protection against harmful interference when the product is operated in a commercial environment. This product generates, uses, and can radiate radio frequency energy, and if not installed and used in accordance with the instruction manual, might cause harmful interference to radio communications. Operation of this product in a residential area is likely to cause harmful interference, in which case you will be required to correct the interference at your own expense.

IMPORTANT

Changes or modifications not expressly approved by the party responsible for compliance could void the user's authority to operate the product.

FCC Supplier's Declaration of Conformity

Hereby declares that the product,

Product name: 27MG

Model: 27MG-MR/27MG-CW

Conforms to the following specifications:

FCC Part 15, Subpart B, Section 15.107 and Section 15.109.

Supplementary information:

This device complies with Part 15 of the FCC Rules. Operation is subject to the following two conditions:

- (1) This device may not cause harmful interference.
- (2) This device must accept any interference received, including interference that may cause undesired operation.

Responsible party name:

EVIDENT SCIENTIFIC INC.

Address:

48 Woerd Avenue, Waltham, MA 02453, USA

Phone number:

+1 781-419-3900

ICES-001 (Canada) Compliance

This Class A digital apparatus complies with Canadian ICES-001.

Cet appareil numérique de la classe A est conforme à la norme NMB-001 du Canada.

Warranty Information

Evident guarantees your Evident product to be free from defects in materials and workmanship for a specific period, and in accordance with conditions specified in the Terms and Conditions available at <https://www.olympus-ims.com/en/terms/>.

The Evident warranty only covers equipment that has been used in a proper manner, as described in this instruction manual, and that has not been subjected to excessive abuse, attempted unauthorized repair, or modification.

Inspect materials thoroughly on receipt for evidence of external or internal damage that might have occurred during shipment. Immediately notify the carrier making the delivery of any damage, because the carrier is normally liable for damage during shipment. Retain packing materials, waybills, and other shipping documentation needed in order to file a damage claim. After notifying the carrier, contact Evident for assistance with the damage claim and equipment replacement, if necessary.

This instruction manual explains the proper operation of your Evident product. The information contained herein is intended solely as a teaching aid, and shall not be used in any particular application without independent testing and/or verification by the operator or the supervisor. Such independent verification of procedures becomes increasingly important as the criticality of the application increases. For this reason, Evident makes no warranty, expressed or implied, that the techniques, examples, or procedures described herein are consistent with industry standards, nor that they meet the requirements of any particular application.

Evident reserves the right to modify any product without incurring the responsibility for modifying previously manufactured products.

Technical Support

Evident is firmly committed to providing the highest level of customer service and product support. If you experience any difficulties when using our product, or if it fails to operate as described in the documentation, first consult the user's manual, and then, if you are still in need of assistance, contact our After-Sales Service. To locate the nearest service center, visit the Service Centers page on the Evident Scientific Web site.

1. Instrument Description

This chapter describes the main features and hardware components of the 27MG Ultrasonic Thickness Gauge instrument.

IMPORTANT

The portable document format (PDF) file for the *27MG Ultrasonic Thickness Gauge – User’s Manual* is included on the documentation CD that is shipped with the 27MG.

1.1 Product Description

The 27MG instrument is a handheld ultrasonic thickness gauge designed for a wide variety of thickness-measurement applications. With the 27MG, you only need access to one side of a part in order to obtain nondestructive measurements of the thickness of corroded, pitted, granular, and other difficult materials.

The 27MG operates with dual element transducers and can measure material thicknesses between 0.50 mm and 635.0 mm (0.020 in. and 25.0 in.). The temperature range of measured materials may vary between $-20\text{ }^{\circ}\text{C}$ and $500\text{ }^{\circ}\text{C}$ ($-4\text{ }^{\circ}\text{F}$ and $932\text{ }^{\circ}\text{F}$), depending on the material’s characteristics, the transducer, and the measurement mode.

Basic features

- Measurement-related status flags and alarms
- LED back-lite display
- Automatic probe recognition for the standard D79X transducers

- Calibration for unknown material sound velocity and/or transducer zero
- Fast scan mode with 20 readings per second
- Hold or blank thickness display during loss-of-signal (LOS) conditions
- Hold minimum and maximum functions
- Differential thickness display relative to the set point in absolute values or percentage ratios
- Selectable resolution: low of 0.1 mm (0.01 in.), standard of 0.01 mm (0.001 in.)

1.2 Environmental Ratings

The 27MG Ultrasonic Thickness Gauge instrument is a rugged and durable instrument that can be used in harsh environments. The 27MG was designed to meet the requirement of the IP65 rating (Ingress Protection rating).



CAUTION

Evident cannot guarantee any level of Ingress Protection rating once the instrument seals have been manipulated. You must use sound judgment, and take proper precautions before exposing the instrument to harsh environments.

To maintain the original level of Ingress Protection, you are responsible for the proper care of all routinely exposed membrane seals. Additionally, you are responsible for returning the instrument to an authorized Evident service center on an annual basis to ensure that the instrument seals are properly maintained.

1.3 Instrument Hardware Components

The 27MG front panel features a display and a keypad. The instrument comes with a wrist strap. An optional protective rubber boot includes strap rings at the four corners (see Figure 1-1 on page 25).

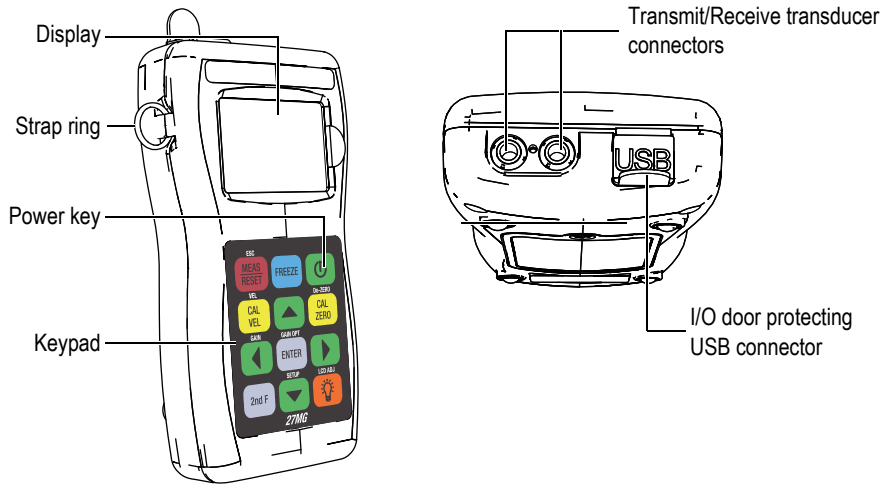

Figure 1-1 The 27MG hardware components — Front and top views

1.4 Connectors

Figure 1-2 on page 25 illustrates the possible connections between the 27MG and external devices.

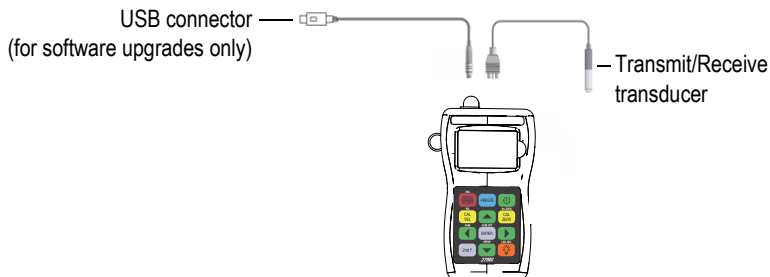

Figure 1-2 The 27MG connections

The universal serial bus (USB) and Transmit/Receive transducer connectors are located on the top of the 27MG (see Figure 1-3 on page 26). The USB connector on the 27MG is used for upgrading the internal operating software as well as powering the instrument.

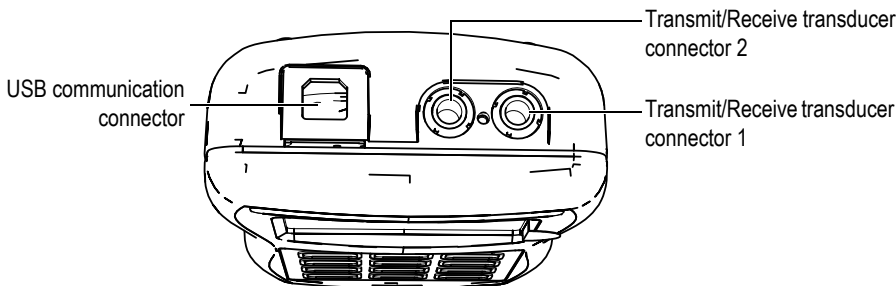

Figure 1-3 The top end connectors

1.5 Keypad Functions

The 27MG comes either with the English or the international keypad (see Figure 1-4 on page 26). The functions are the same for both keypads. On the international keypad, the text labels on many keys are replaced by pictograms. In this document, keypad keys are referred to using the English label in bold and within brackets (ex.: [MEAS]).

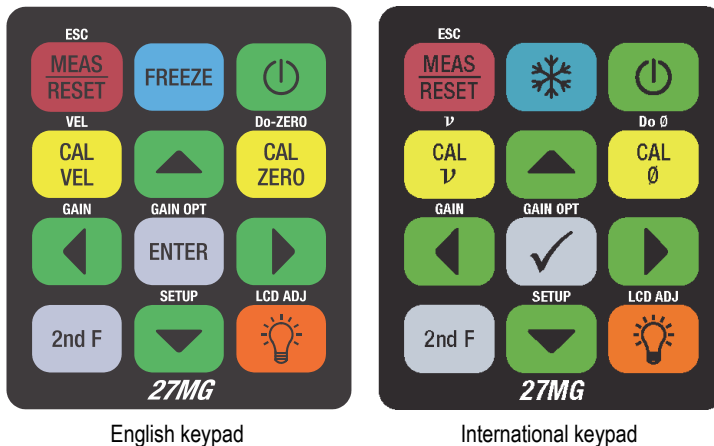

Figure 1-4 The 27MG keypads

Each key is labelled according to its primary function. The area immediately above certain keys contains a secondary key function that can be activated by first pressing [2nd F]. Throughout this document, references to a secondary function are written as follows: [2nd F], [Primary] (Secondary). For example, the instruction to activate the gain adjust function is written as follows:

Press [2nd F], [◀] (Gain).

The [▲], [▼], [◀], and [▶] keys, along with the [ENTER] key, are used to select menu items or display parameters, and to change parameter values. Use the [MEAS] key at any time to return to the measurement screen. The yellow keys are related to calibration.

Table 1 on page 27 lists the key functions available on the 27MG keypad.

Table 1 Keypad functions













English	International	Functions
		Measurement — Completes the current operation and returns to the measurement screen.
		Secondary function — When pressed prior to another key, activates the secondary function of that key.
		Freeze — Puts the displayed screen or waveform on hold until the key is pressed again.
		Gain — Initiates the adjustment of the gain value when using dual element transducers.
		Enter — Selects a highlighted item, or accepts an entered value.
		Up arrow <ul style="list-style-type: none"> In a screen or a list, moves to the previous element. For some parameters, increases the value of a numerical entry.

Table 1 Keypad functions (continued)





















English	International	Functions
		Down arrow <ul style="list-style-type: none"> In a screen or a list, moves to the next element. For some parameters, decreases the value of a numerical entry.
		Left arrow <ul style="list-style-type: none"> Selects the previous available value for the selected parameter. In text edit mode, moves the cursor one character position to the left.
		Right arrow <ul style="list-style-type: none"> Selects the next available value for the selected parameter. In text edit mode, moves the cursor one character position to the right.
		Velocity calibration — Switches to the semiautomatic material velocity calibration mode.
		Velocity — Opens a screen allowing you to view and manually change the sound velocity.
		Zero calibration <ul style="list-style-type: none"> Compensates for transducer zero, or enables the step block zero calibration. With the traditional text edit mode only, inserts a character at the cursor position.
		Do-ZERO — Compensates for transducer delay for dual element transducers.
		Setup menu — Provides access to instrument parameters (measurement, system, display, alarm, differential mode, and communication menu).

Table 1 Keypad functions (continued)

English	International	Functions
		Power — Turns the instrument power on or off.
		LCD Adjust — Turns on or off the backlight feature that internally illuminates the LCD screen.

2. 27MG Power Requirements

This chapter describes how to power the 27MG Ultrasonic Thickness Gauge instrument using different power options.

2.1 Power Indicator

The battery indicator is always present on the bottom-right corner of the screen. The 27MG can be powered by three AA-sized batteries, by a computer through its USB connector, or by a commercially available 5-volt USB power supply.

When using batteries, the vertical bars in the battery indicator indicate the remaining battery power level (see Figure 2-1 on page 31). Each graduation mark represents 25 % of the power level.

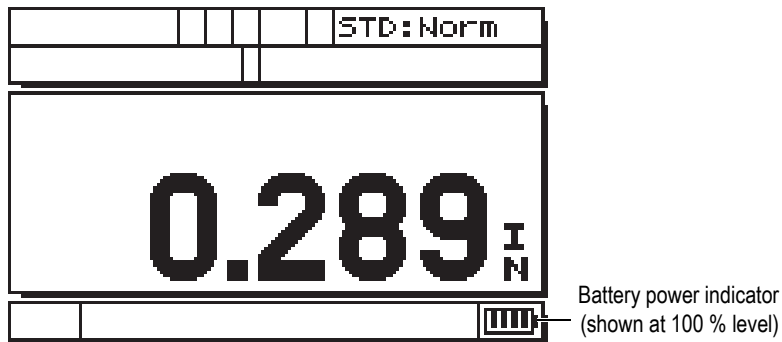

Figure 2-1 The power indicator when using batteries

2.2 Batteries

The 27MG Ultrasonic Thickness Gauge comes with three AA-sized alkaline batteries.

The 27MG instrument can also be operated using three AA-sized nickel-metal hydride (NiMH) rechargeable batteries. The 27MG does not recharge NiMH batteries. To recharge the batteries, you must use a commercially available external battery charger (not included).

2.2.1 Battery Operating Time

The battery operating time depends on the type of batteries being used, the age of the batteries, and the instrument settings. To provide realistic battery operating times, the 27MG Ultrasonic Thickness Gauge has been tested with mid-level operating parameters (update rate set to 4 Hz).

The nominal alkaline battery operating times for new batteries is 150 hours under normal conditions (typical 30 hours continuous with back light). The battery symbol in the bottom right corner of the display indicates remaining battery level.

2.2.2 Battery Level and Storage

When the batteries are full (100 % level), the battery power indicator will show four bars (see Figure 2-1 on page 31).

When the 27MG instrument is not being used for a prolonged period of time, remove the batteries and store them by doing the following:

- Store batteries in a cool, dry environment.
- Avoid long-term storage under sunlight, or in other excessively hot places such as the trunk of an automobile.

2.2.3 Battery Replacement

The batteries are located in a compartment that is accessible from the back of the 27MG (see Figure 2-2 on page 33).

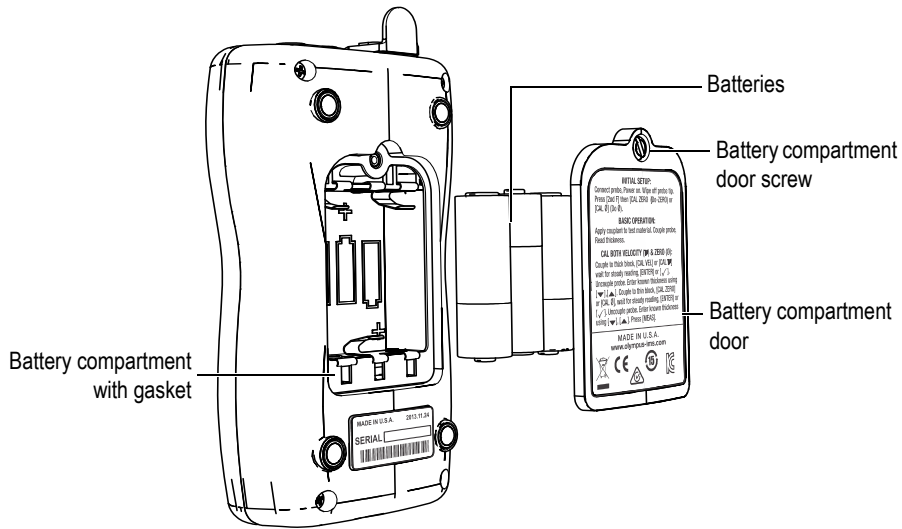

Figure 2-2 Opening the battery compartment



CAUTION

Do not replace the batteries while the instrument is on. Dispose of used batteries promptly. Keep batteries out of reach of children. The batteries used in this device may present a risk of fire or chemical burn if mistreated. Do not disassemble, heat above 50 °C (122 °F), or incinerate the batteries.

To replace the batteries

1. Ensure that the 27MG is turned off.
2. Disconnect any cables that are connected to the 27MG.
3. Remove the optional protective rubber boot, if installed.
4. Unscrew the captive screw on the battery door screw by turning it counterclockwise.
5. Remove the battery compartment door.
6. Unclip the AA-sized batteries from the battery clips.

7. Insert three AA-sized alkaline or NiMH rechargeable batteries in the battery compartment, making sure that you observe the correct polarity.
8. Reinstall the battery compartment door on the back of the instrument, push down on the bottom of the battery door, and then turn the battery door screw clockwise.

NOTE

Always dispose of batteries properly as required by your local regulations.

9. Reinstall the optional protective rubber boot, if required.
10. Press the power [] button to turn on the 27MG instrument.
11. To answer the battery type setup question displayed at the bottom of the screen, use the right or left arrow keys, and then press [ENTER] (see Figure 2-3 on page 34):
 - Select **ALKALINE** when using three AA-sized alkaline batteries.
 - Select **NiMH** when using three AA-sized nickel-metal hydride (NiMH) batteries).

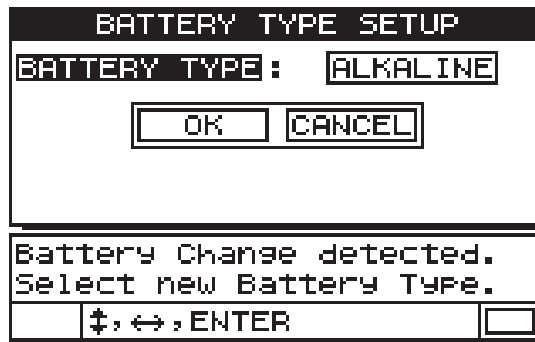

Figure 2-3 Selecting the battery type

NOTE

When replacing batteries, make sure that they are full in order to ensure the accuracy of the estimated remaining battery power level shown by the power indicator.

3. Software User Interface Elements

The following sections describe the main elements of the 27MG Ultrasonic Thickness Gauge software screens and menus.

3.1 Measurement Screen

The 27MG instrument's main measurement screen contains the elements described in Figure 3-1 on page 35.

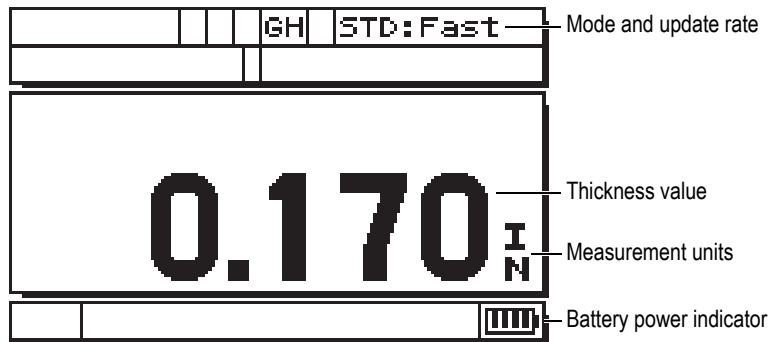

Figure 3-1 The measurement screen

The measurement screen is the main screen of the 27MG software. From anywhere in the 27MG software, simply press [MEAS] to return to the measurement screen. The power indicator is always present on the bottom-right corner of the 27MG screen (see "Power Indicator" on page 31 for details).

Depending on the context, and on the available functions, various indicators and numeric values appear on the display around the main measurement value (see Figure 3-2 on page 36). When a combination of keys is pressed, a help message appears that indicates the keys to use to navigate and make selections within the menu.

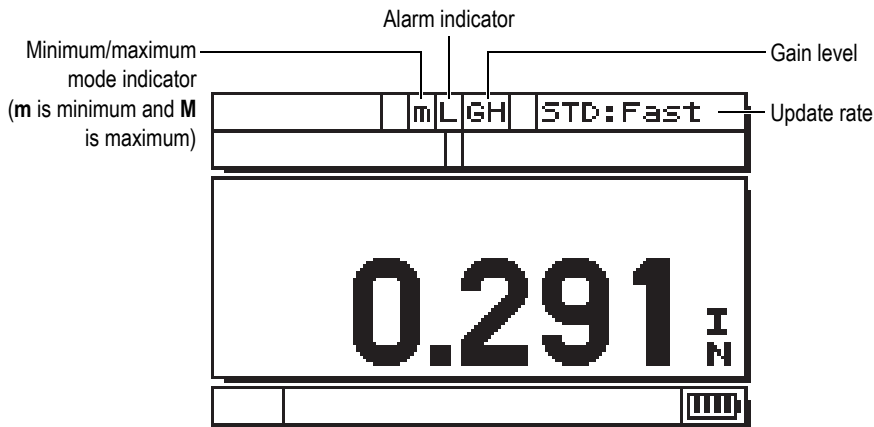

Figure 3-2 Other elements of the measurement screen

3.2 Parameter Screens

The 27MG setup parameters are logically grouped in tabs that can be accessed using the [2nd F] and down arrow [▼] (SETUP) front panel keys. Figure 3-3 on page 37 shows the MEAS tab as an example.

Once in the tabs, you can use the right and left arrow key to select a different tab and the up and down arrow keys to select a parameter to change within a tab. To change a parameter in a tab, use the right or left arrows keys. Press the [MEAS] key to leave the SETUP tab and return to the measurement screen.

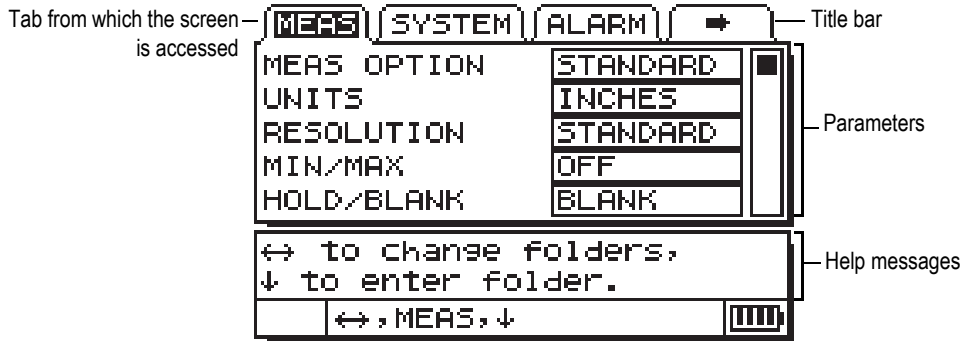

Figure 3-3 Parameter screen example

NOTE

In the remainder of this document, the above procedure is summarized by the simple instruction to select a specific parameter or list, and its value. For example:

In the **MEAS** tab, set **UNITS** to **INCHES**.

4. Initial Setup

This chapter demonstrates basic 27MG setup techniques. The unit is shipped from the factory, setup with the default conditions provided in Table 2 on page 39.

Table 2 Default conditions

Condition	Comment
Standard resolution	0.01 mm (0.001 in.)
Sound velocity	5.740 mm/ μ s (0.2260 in./ μ s). (Approximate sound velocity for the carbon steel test bar provided with the gauge.) See note below.
Blank mode	Display is blank when not making a measurement.

These conditions have been selected to demonstrate the instrument's ease of use. Further explanation of these default conditions can be found in later sections of this manual. These conditions may be changed after the operator becomes familiar with the advanced features of the gauge.

NOTE

The default value for sound velocity is only an approximation of the sound velocity in the test block material. The sound velocity of low to medium carbon alloy steel is typically 5.740 mm/ μ s (0.2260 in./ μ s). Therefore, if you find the default value gives inaccurate results on your material, refer to the calibration instructions.

To operate the 27MG Ultrasonic Thickness Gauge for the first time, the initial setup must be completed.

To perform the initial setup

1. Plug the transducer into the connector at the top end of the 27MG case.

NOTE

When unplugging a transducer, ONLY pull on the molded plug, NOT on the cable.

2. Press the power [] key to turn the gauge on.

The transducer should NOT be coupled to the test piece. After the power-up screen, the word **Do--** appears on the display (see Figure 4-1 on page 40).



Figure 4-1 Transducer zero compensation

This means that the gauge requires the following transducer zero compensation step.

3. Wipe any couplant from the tip of the transducer.
4. Press [2nd F], [CAL ZERO] (Do-ZERO).

The gauge displays a zero value and then displays the measurement screen (see Figure 4-2 on page 41).

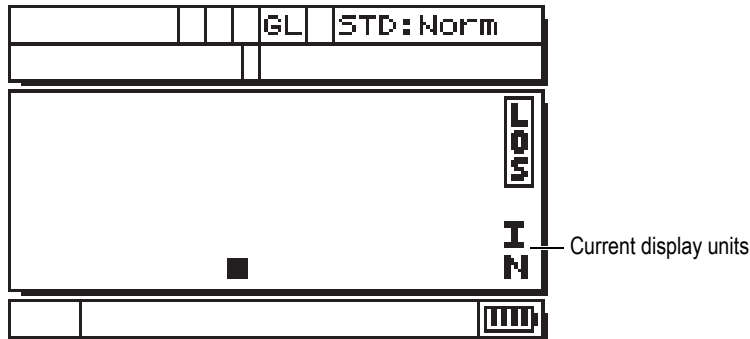

Figure 4-2 The Zero screen

5. You are now ready to make measurements. The current units are indicated on the right of the display. Alternate between millimeters (MM) and inches (IN) by pressing [2nd F], [▼] (SETUP), then pressing [▼] to highlight the current display units and using [◀, ▶] to select imperial (inches) or metric (millimeters) units.
6. Press the [MEAS] key.

NOTE

The initial setup is not a substitute for doing a standard calibration (see “Standard Calibration Measurement” on page 43).

5. Standard Calibration Measurement

Before accurate measurements can be made on a particular material, using a particular transducer at a particular temperature, the 27MG Ultrasonic Thickness Gauge must be properly calibrated.

5.1 Introduction

The 27MG calibration procedure adjusts the gauge so that it measures accurately on a particular material, using a particular transducer at a particular temperature. Calibration procedures include:

- **Transducer zero compensation**—Calibrates for the sound transit time in each of the dual transducer delay lines, which varies from unit to unit and with temperature. This simple off-block procedure must be done when the gauge is turned on, when the transducer is changed, and whenever the transducer temperature changes significantly.
- **Material velocity calibration or CAL VEL**—Done using a thick test block of the measured material with known thickness or by entering the previously determined material velocity manually. It must be performed for each new type of material.
- **Zero calibration or CAL ZERO**—Done using a thin test block of the measured material with known thickness. Unlike the first two calibrations, this procedure is not required unless the best absolute accuracy is demanded (better than ± 0.10 mm [± 0.004 in.]). If required, it needs to be done only once for each new transducer and material combination. It does not have to be repeated when the transducer temperature changes. Transducer zero compensation will adjust for temperature changes in the transducer.

5.2 Transducer Zero Compensation

This step must be done whenever the message **Do--** and the **DO ZERO** flag are displayed (see Figure 5-1 on page 44).

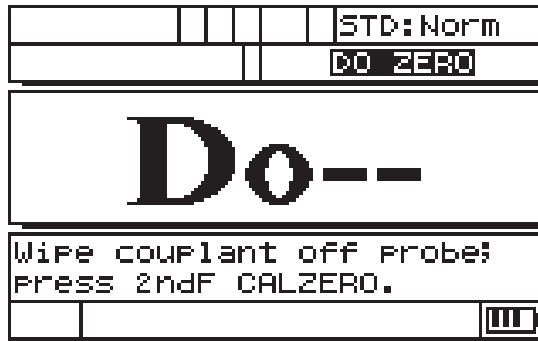

Figure 5-1 The Do-- screen

To do the transducer zero compensation, wipe any couplant from the transducer face, and press [2nd F], [CAL ZERO] (**Do-ZERO**). The gauge will momentarily display the zero calibration value and then automatically go into measurement mode. When measurements are being made on surfaces that are significantly above or below room temperature, [2nd F], [CAL ZERO] (**Do-ZERO**) should be pressed to compensate for any temperature changes in the transducer.

5.3 Velocity and Zero Calibration

The material velocity and zero calibration procedures may be combined using a thick and a thin calibration block of the same material.

1. Update the transducer zero compensation by wiping the transducer face and pressing [2nd F], [CAL ZERO] (**Do-ZERO**) or [2nd F], [CAL Ø] (**Do Ø**).
2. Couple the transducer to the thick calibration block.
3. Press [CAL VEL] or [CAL v].
4. When the thickness reading is stable, press [ENTER] or [P].

5. Uncouple the transducer from the block and use the [▲], [▼], [◀], and [▶] arrow keys to enter the thickness of the thick block.
6. Couple the transducer to the thin block and press [CAL ZERO] or [Cal Ø].
7. When the reading is stable, press [ENTER] or [✓].
8. Uncouple the transducer from the block and use the [▲], [▼], [◀], and [▶] arrow keys to enter the thickness of the thin block.
9. Press the [MEAS] key to complete the calibration and go to the measurement mode.

NOTE

Velocity calibration should always be performed on the thick sample and zero calibration should always be performed on the thin sample.

NOTE

Before calibrating, the measured thickness value while coupled to the thin calibration block should be within ± 0.20 mm (± 0.010 in.) of the correct thickness. If the indicated thickness is two or more times the actual thickness of the thin calibration block with a good approximate sound velocity, the gauge is *doubling*, that is, measuring to the second or third multiple echo. Do not attempt to do a velocity and zero calibration under this condition. Doing so will cause an error. Instead, correct the cause of the doubling. Either the calibration block is thinner than the specified capability of the transducer, the transducer is malfunctioning, or the gauge is malfunctioning.

5.4 Material Velocity Calibration

Material velocity calibration is to be performed when material sound velocity is unknown by using a calibration block made from the material to be measured. When material sound velocity is known, the velocity may be entered directly.

5.4.1 When Material Sound Velocity Is Unknown

To perform the material velocity calibration, a calibration block made from the material to be measured must be used. The block should be approximately as thick as the thickest section to be measured and have flat, smooth, and parallel front and back surfaces. The thickness of the block must be known exactly (see Figure 5-2 on page 46).



Figure 5-2 The unknown sound material Do-- screen

To calibrate for unknown material velocity

1. Update the transducer zero compensation by wiping the transducer face clean of all couplant and pressing [2nd F], [CAL ZERO] (Do-ZERO).
2. Couple the transducer to the block.
3. Press the [CAL VEL] key.
4. When the thickness reading is stable, press the [ENTER] key.
5. Uncouple the transducer and use the [▲], [▼], [◀], and [▶] arrow keys to enter the thickness of the standard.
6. Press the [MEAS] key to complete the calibration and return to measurement mode.

If the gauge double beeps before returning to measurement mode, then an error has been made in the calibration procedure and the velocity has not been changed. The most likely problem is that the thickness value entered was not correct.

[2nd F], [CAL VEL] (VEL) may be pressed following velocity calibration (or at any time in measurement mode) in order to read and record the material velocity for this particular material. When measuring this material in the future, this velocity may be entered by means of the arrow keys, without using the block.

NOTE

Sound velocity in all materials changes with temperature. For maximum accuracy, the calibration block should be at approximately the same temperature as the samples to be measured.

5.4.2 When Material Sound Velocity Is Known

When preparing to measure a different material of known sound velocity, the velocity may be entered directly without doing the CAL VEL procedure discussed above.

To calibrate for a known material velocity

1. In measurement mode press [2nd F], [CAL VEL] (VEL). The current velocity will be displayed.
2. This number may then be changed to the desired value using the [▲], [▼], [◀], and [▶] arrow keys.
3. Press [MEAS] to complete the entry and return to measurement mode. If the gauge is turned off before the [MEAS] key is pressed, the velocity will not be updated to the new value, but instead will retain the previous value.

5.5 Zero Calibration

To do the zero calibration, a calibration block of the material to be measured must be used. The block should be approximately as thin as the thinnest section to be measured. If the surface of the material to be inspected is rough, the surface of the calibration block may be roughened to simulate the actual surface to be measured. Rough surfaces generally reduce the accuracy of measurements, but simulating actual surface conditions on the calibration block can help to improve results. The exact thickness of the sample must be known.

To perform the zero calibration

1. Update the transducer zero compensation by wiping the transducer face clean of all couplant and pressing [2nd F], [CAL ZERO] (Do-ZERO) while in measurement mode.
2. Couple the transducer to the standard.
3. Press the [CAL ZERO] key.
4. When the thickness reading is stable, press the [ENTER] key. The [ENTER] key will not be accepted if the LOS flag is displayed.
5. Uncouple the transducer and use the [▲], [▼], [◀], and [▶] arrow keys to enter the thickness of the standard.
6. Press the [MEAS] key to complete the calibration and return to measurement mode. If the gauge is turned off before the [MEAS] key is pressed, the zero value will not be updated to the new value, but instead will retain the previous value.

If the gauge sounds a long beep before returning to measurement mode, an error has been made in the calibration procedure and the zero value has not been changed. The most likely cause is that the entered thickness was not correct.

6. Measurements

Once the initial setup of the 27MG Ultrasonic Thickness Gauge has been performed (see chapter “Initial Setup” on page 39) and a standard calibration has been completed (see “Standard Calibration Measurement” on page 43), measurements can be made.

To make measurements

1. Apply couplant to the test block or material at the spot to be measured.

IMPORTANT

In general, the smoother the material surface, the thinner the couplant may be. Rough surfaces require more viscous couplant such as gel or grease. Special couplants are required for high temperature applications.

-
2. Press the tip of the transducer to the surface of the material to be measured. Use moderate to firm pressure and keep the transducer as flat as possible on the material’s surface.
 3. Read the material’s thickness on the gauge display.

NOTE

For highest accuracy, both a velocity and zero calibration must be done.

7. Additional 27MG Gaging Features

The 27MG Ultrasonic Thickness Gauge has several additional convenient features. The use of these features is not required for basic operation. However, they make the gauge a more versatile instrument.

The following additional features can be accessed directly from the keypad:

- Backlight
- Freeze
- Gain adjust
- Material gain sensitivity optimization
- Default gain restoration

Other features can be accessed in the setup mode. To access or change any of these functions, press [2nd F], [▼] (SETUP).

These features include the following functions:

- Inches/Millimeters conversion
- Resolution
- Min/Max
- Hold/Blank
- Measure Rate
- CAL Lock
- Beeper
- Inactive time
- Radix
- Backlight mode
- Alarm

- Differential mode
- Resets

7.1 Adjusting the Backlight

The display backlight feature internally illuminates the liquid crystal display with a bright, uniform light. This allows the display, which has excellent visibility in normal to high ambient light conditions, to be viewed in low to zero ambient light conditions.

To switch backlight on or off

- ◆ Press the LCD adjust [] key.

Additionally, when the backlight is switched on, you may select a power-saver auto backlight mode, which only turns the backlight on when a reading is being made and then turns it off five seconds after LOS.

To select auto backlight

1. Press [2nd F], [▼] (SETUP).
2. Use [▶] to select the **SYSTEM** tab.
3. Use the [▼] key to highlight **BACKLIGHT** mode.
4. Use the [◀] and [▶] keys to change between **NORMAL** and **AUTO**.
5. Press [MEAS] to return to measurement mode with the new settings.

To adjust contrast

The contrast adjustment feature allows the 27MG Ultrasonic Thickness Gauge to adjust the contrast (light or dark) of the display.

To adjust the display contrast

1. From measurement mode, press [2nd F], LCD adjust [] (LCD ADJ).
2. Use the [▲] or [▼] key to adjust the contrast.
3. Press [ENTER] to exit the contrast adjustment mode.

7.2 Activating the Freeze Mode

The Freeze function allows the operator to freeze the thickness display when the [FREEZE] key is pressed. The display is returned to an active status by pressing [FREEZE] a second time or by pressing [MEAS]. This function is useful when the user wishes to hold a displayed thickness reading. This helps limit the transducer contact time during high temperature thickness measurement applications. The Freeze function can also be used in combination with the Min/Max function.

7.3 Adjusting the Gain

The gain adjustment increases or decreases the normal measurement sensitivity by a fixed amount (approximately 10 dB high gain and -6 dB low gain). This function is available for those applications for which more or less than the default sensitivity is required but the use of a fixed sensitivity increase rather than a sensitivity proportional to the measured noise is preferred. Use of the gain adjustment function is generally recommended for all high temperature measurements.

To adjust the gain from the default gain value

- ◆ From the measurement mode, press [2nd F], [◀] (GAIN) to toggle between GAIN HIGH, to GAIN LOW, and DEFAULT GAIN.

7.4 Optimizing Material Gain Sensitivity

The material gain sensitivity optimization feature allows the normal measurement sensitivity to be increased or decreased by an amount related to the measured peak noise in a specific transducer and material combination. Normally, the 27MG Ultrasonic Thickness Gauge adjusts the receiver gain and detection level depending on both the transducer type and the received echo characteristics. Also, each transducer type imposes its own maximum gain and detection threshold to prevent any transducer-related or material-related noise from being seen as a thickness echo. This works well in most corroded material gaging applications. However, in certain special cases, it is advantageous to modify these fixed limits on the sensitivity.

The material gain sensitivity optimization feature optimizes actual material noise level measurements rather than fixed gain boost or fixed attenuators. While the transducer is coupled to a thick sample of the material of interest, the gauge measures

the peak noise level up to a specified backwall thickness. Then the gain and detection threshold values are adjusted to produce the minimum backwall sensitivity without hanging up on noise.

Performing the sensitivity optimization procedure on different materials may yield different results. In the case of grainy materials such as cast iron, or high surface noise materials such as aluminum, this procedure may result in a decrease in gain. In the case of hot materials with rough surfaces or other highly attenuating but low noise materials, this procedure may produce an increase in sensitivity.

To perform automatic material gain sensitivity optimization

1. From the measurement mode, press [**2nd F**], [**ENTER**] (**GAIN OPT**). The gauge will display 0.000.
2. Use the [**▲**], [**▼**], [**◀**], and [**▶**] keys to select to the approximate wall thickness. It is best to guess low if you are uncertain.
3. Couple the transducer to the material sample and press [**MEAS**]. Optimization will be performed and the gauge will return to the measurement mode. The gain flag will indicate that the gain is not at default gain by displaying **GO** (Gain Optimized).

7.5 Restoring the Default Gain

You can restore the default gain directly.

To restore the Default Gain

- ◆ Press [**2nd F**], [**◀**] (**GAIN**).

7.6 Configuring the Measurement Setup

The measurement setup menu allows the user to turn on or off many of the additional measurement features of the 27MG Ultrasonic Thickness Gauge.

Measurement setup features include the following functions:

- Units
- Resolution
- Min/Max

- Hold/Blank
- Measure rate
- CAL Lock

7.6.1 Changing Units

Changing units allows the user to change from inch measurement units to millimeter measurement units.

To change units

1. Press [**2nd F**] [**▼**] (**SETUP**) to display the setup tabs.
2. Use the [**◀**, **▶**] keys to highlight the **MEAS** tab.
3. Use the [**▼**] key to highlight **UNITS** and the [**◀**, **▶**] keys to select imperial (**IN**) or metric (**MM**) display units.
4. Press [**MEAS**] to return to measurement mode.

7.6.2 Changing Resolution

Resolution allows the user to change the number of decimal points displayed in the thickness display.

The user can select between **STANDARD** (0.01 mm [0.001 in.]) and **LOW** (0.1 mm [0.01 in.]).

To change resolution

1. Press [**2nd F**] [**▼**] (**SETUP**) to display the setup tabs.
2. Use the [**◀**, **▶**] keys to highlight the **MEAS** tab.
3. Use the [**▼**] key to highlight **RESOLUTION** and the [**◀**, **▶**] keys to select **STANDARD** or **LOW**.
4. Press [**MEAS**] to return to measurement mode.

7.6.3 Configuring Min or Max Mode

The Min/Max mode allows the user to put the gauge in minimum (**MIN**) or maximum (**MAX**) scanning mode. This feature allows the user to scan over an area and quickly determine the minimum or maximum thickness.

Min mode displays live thickness values and recalls the minimum thickness when a loss-of-signal (LOS) occurs. Live thickness values are displayed in filled-in form, and recalled min values are displayed in outlined form. The minimum values are retained in a temporary memory until new minimum thickness values replace them or until the [MEAS] key is pressed to reset the minimum. When **MIN** is selected, the 27MG automatically changes to 20 Hz fast update mode.

Max mode displays live thickness value and recalls the maximum thickness when a LOS occurs. Live thickness values are displayed in filled-in form, and recalled max values are displayed in outlined form. The maximum value is retained in a temporary memory until a new maximum thickness value replaces it or until the [MEAS] key is pressed to reset the maximum. When **MAX** is selected, the 27MG automatically changes to a 20 Hz fast update mode.

To configure the Min/Max mode

1. Press [2nd F] [▼] (SETUP) to display the setup tabs.
2. Use the [◀, ▶] keys to highlight the **MEAS** tab.
3. Use the [▼] key to highlight **MIN/MAX** and the [◀, ▶] keys to select among **OFF**, **MIN**, or **MAX**.
4. Press [MEAS] to return to measurement mode.

7.6.4 Configuring Hold or Blank Mode

The Hold/Blank mode controls:

- **HOLD**: The gauge holds the last measurement when no measurements (LOS) are being made.
- **BLANK**: The display blanks out the thickness value when no measurements (LOS) are being made.

The 27MG is set by default to blank out the measurement display when no measurements are being made. When **HOLD** is selected, live (active) thickness readings are displayed with filled-in numbers and held measurements are displayed with outlined numbers.

To configure the Hold/Blank mode

1. Press [2nd F], [▼] (SETUP) to display the setup tabs.
2. Use the [◀, ▶] to highlight the **MEAS** tab.

3. Use the [▼] key to highlight **HOLD/BLANK** and [◀, ▶] to select between **BLANK** and **HOLD**.
4. Press [MEAS] to return to measurement mode.

7.6.5 Changing the Measure Rate Parameter

The Measure Rate parameter allows the user to display the measurement update rate. The user can select between **NORMAL** (4 Hz) and **FAST** (20 Hz).

NOTE

Changing to the fast update rate will greatly affect the battery life of the 27MG Ultrasonic Thickness Gauge.

To change the Measure Rate parameter

1. Press [2nd F] [▼] (**SETUP**) to display the setup tabs.
2. Use the [◀, ▶] keys to highlight the **MEAS** tab.
3. Use the [▼] key to highlight **MEASURE RATE** and the [◀, ▶] keys to select between **NORMAL** (4 Hz) and **FAST** (20 Hz).
4. Press [MEAS] to return to measurement mode.

7.6.6 Activating CAL LOCK

The **CAL LOCK** function allows the user to lock the calibration so that it cannot be changed while **CAL LOCK** is enabled. If the user tries to change the calibration while the lock is activated, the gauge displays a **CAL LOCK** message.

To activate CAL LOCK

1. Press [2nd F] [▼] (**SETUP**) to display the setup tabs.
2. Use the [◀, ▶] keys to highlight the **MEAS** tab.
3. Use the [▼] key to highlight **CAL LOCK** and [◀, ▶] to select between **OFF** and **ON**.
4. Press [MEAS] to return to measurement mode.

7.7 Configuring the System Setup

The System Setup functions allow the user to turn on or off many 27MG Ultrasonic Thickness Gauge configurations. They are available on the **SYSTEM** tab.

The **SYSTEM** tab gives access to the following functions:

- Beeper
- Inactive Time
- Radix
- Backlight mode

7.7.1 Configuring the Beeper

The beeper allows the user to turn the audio beeper of the 27MG Ultrasonic Thickness Gauge on and off.

The beeper is set to on by default and will generate an audio beep when any key is pressed or when an alarm condition has been detected.

To configure the beeper

1. Press [**2nd** F] [**▼**] (**SETUP**) to display the setup tabs.
2. Use the [**◀**, **▶**] keys to highlight the **SYSTEM** tab.
3. Use the [**▼**] key to highlight **BEEPER** and [**◀**, **▶**] to select between **OFF** and **ON**.
4. Press [**MEAS**] to return to measurement mode.

7.7.2 Changing the Inactive Time Parameter

The Inactive Time parameter allows the user to set the **AUTO POWER OFF** feature to either **ON** or **OFF**.

When the **INACTIVE TIME** is set to **ON**, the 27MG Ultrasonic Thickness Gauge powers off after approximately six minutes of inactivity.

When the **INACTIVE TIME** is set to **OFF**, the 27MG unit remains powered up until the user turns the unit off or the battery voltage becomes low.

To change the Inactive Time parameter

1. Press [2nd F] [▼] (SETUP) to display the setup tabs.
2. Use the [◀, ▶] keys to highlight the **SYSTEM** tab.
3. Use the [▼] key to highlight **INACTIVE TIME** and [◀, ▶] to select between **OFF** and **ON**.
4. Press [MEAS] to return to measurement mode.

7.7.3 Changing the Radix Parameter

The Radix parameter allows the user to select the display of the radix character (the character that separates the whole and decimal part of the thickness value).

In many countries, the comma (,) is used (example: 1,25 mm). In the United States, the period (.) is used as radix (example: 0.123 in.).

To change the Radix parameter

1. Press [2nd F] [▼] (SETUP) to display the setup tabs.
2. Use the [◀, ▶] keys to highlight the **SYSTEM** tab.
3. Use the [▼] key to highlight **RADIX** and [◀, ▶] to select between **PERIOD** and **COMMA**.
4. Press [MEAS] to return to measurement mode.

7.7.4 Changing the Backlight Mode

The Backlight mode allows the user to determine how the backlight works once it has been turned on.

When **BACKLIGHT** mode is set to **NORMAL**, the backlight will stay on until it is turned off.

When **BACKLIGHT** mode is set to **AUTO** and the backlight is turned on, it will stay on while a thickness measurement is being displayed and automatically turn off five seconds after a loss-of-signal (LOS) has occurred.

To change the Backlight mode

1. Press [2nd F] [▼] (SETUP) to display the setup tabs.

2. Use the [◀, ▶] keys to highlight the **SYSTEM** tab.
3. Use the [▼] key to highlight **BACKLIGHT** mode and [◀, ▶] to select between **NORMAL** and **AUTO**.
4. Press [MEAS] to return to measurement mode.

7.8 Activating High/Low Alarms

The High/Low alarm allows the user to establish high and low alarm set points.

When a thickness is displayed below the Low Alarm set point or above the High Alarm set point, an audio beep is sounded and one of the following alarm flags is displayed:

- **A**
When the alarm is active but not above or below set points, the gauge displays an **A**.
- **L**
When a low alarm condition occurs, the gauge displays an **L**.
- **H**
When set points have been violated, a high alarm condition occurs, and the gauge displays an **H**.

NOTE

The Alarm mode and the Diff mode are mutually exclusive (they cannot be used at the same time). If one of these functions is activated, it will be automatically turned off when the other function is turned on.

To activate the High/Low alarm

1. Press [2nd F] [▼] (**SETUP**) to display the setup tabs.
2. Use the [◀, ▶] keys to highlight the **ALARM** tab.
3. Use the [▼] key to highlight **ENABLE** and [◀, ▶] to select **ON** or **OFF**.
4. Press the [▼] key to highlight **LO-ALARM** and then press [▶] key and use the [▲], [▼], [◀], and [▶] keys to select the low alarm set point.

5. Press the [ENTER] key to highlight **HI-ALARM**, then press [▶] and the [▲], [▼], [◀], and [▶] keys to select the high alarm set point.
6. Press [MEAS] to return to measurement mode.

7.9 Activating Diff Mode

The Diff mode allows the user to set a differential (**DIFF**) set point.

When Diff mode is activated, the gauge displays the difference between the Diff set point and the actual thickness value. The gauge displays a **D** to indicate that Diff mode is active.

NOTE

The Alarm mode and the Diff mode are mutually exclusive (they cannot be used at the same time). If one of these function is activated, it will be automatically turned off if the other function is turned on.

To activate Diff mode

1. Press [2nd F] [▼] (**SETUP**) to display the setup tabs.
2. Use the [◀, ▶] keys to highlight the **DIFF** tab.
3. Use the [▼] key to highlight **ENABLE** and [◀, ▶] to select **ON** or **OFF**.
4. Press the [ENTER] key and then use the [▶] key to highlight **DIFF VALUE**. Use the [▲], [▼], [◀], and [▶] keys to select the **DIFF** set point.
5. Press [MEAS] to return to measurement mode.

7.10 Resetting the Instrument Parameters

Resets are used to reset the operating software of the 27MG Ultrasonic Thickness Gauge to their factory default settings. Three resets can be performed: Measurement, Master, and Database.

7.10.1 Resetting Measurement Parameters

The Measurement Reset function resets the measurement parameters to their default values.

The parameters that are reset and their reset values are as follow:

- Material Velocity (0.5740 mm/ μ s [0.2260 in/ μ s])
- Transducer Zero
- Measure Option (Standard)
- Unit (Inches)
- Resolution (Standard)
- Min/Max (Off)
- Hold/Blank (Blank)
- Measure Rate (Normal)
- CAL Lock (Off)
- Beeper (On)
- Inactive Time (On)
- Radix (Period)
- Backlight mode (Normal)
- Alarm (Off). Default Values: Low 0.000; High 25.000
- Diff (Off). Default Value 0.000

To reset measurement parameters

1. Press [**2nd F**] [**▼**] (**SETUP**) to display the setup tabs.
2. Use the [**◀**, **▶**] keys to highlight the **RESET** tab.
3. Use the [**▼**] key to highlight **MEASUREMENT RESET** and press [**ENTER**].
4. Use the [**◀**, **▶**] keys to highlight **RESET** or **CANCEL** and press [**ENTER**].
5. Press [**MEAS**] to return to measurement mode.

7.10.2 Resetting the Entire Instrument Parameters

The Master Reset function resets the entire instrument parameters to their default values.

NOTE

Caution should be used when performing a Master Reset because it will reset all the default setup parameters.

To preset the instrument parameters

1. Press [**2nd F**] [**▼**] (**SETUP**) to display the setup tabs.
2. Use the [**◀**, **▶**] keys to highlight the **RESET** tab.
3. Use the [**▼**] key to highlight **MASTER RESET** and press [**ENTER**].
4. Use the [**◀**, **▶**] keys to highlight **RESET** or **CANCEL** and press [**ENTER**].
5. Press [**MEAS**] to return to measurement mode.

8. Specifications

Table 3 on page 65 contains the general specifications for the 27MG Ultrasonic Thickness Gauge.

Table 3 Specifications

Parameter	Value
Measurements	
Dual element transducer measurement mode	Time interval from a precision delay after the excitation pulse to the first echo.
Thickness range	0.50 mm to 635 mm (0.020 in. to 25.0 in.) depending on material, transducer, surface conditions, temperature.
Material velocity range	0.508 mm/ μ s to 18.699 mm/ μ s (0.020 in./ μ s to 0.7362 in./ μ s)
Resolution (selectable)	Low: 0.1 mm (0.01 in.) Standard: 0.01 mm (0.001 in.)
Transducer frequency range	2.25 MHz to 10 MHz (–3 dB)
General	
Operating temperature range	–10 °C to 50 °C (14 °F to 122 °F)
Keypad	Sealed, color-coded keypad with tactile and audible feedback.
Case	Impact-resistant and water-resistant, gasketed case with sealed connectors. Designed for IP65.
Dimensions (W × H × D)	84.0 mm × 152.4 mm × 39.6 mm (3.31 in. × 6.0 in. × 1.56 in.)
Weight	340 g (12 oz)
Power supply	3 AA alkaline batteries

Table 3 Specifications (continued)

Parameter	Value
Battery operating time	150 h of typical battery life 30 h continuous use with backlight.
Explosive Atmosphere	Safe operation as defined by Class I, Division 2, Group D, as found in the National Fire Protection Association Code (NFPA 70), Article 500, and tested using MIL-STD-810F 511.4 Procedure I.
Standards	Designed for EN15317
Alarm mode	Programmable Hi/Low set points with audible and visual indicators.
Display	
Display Hold/Blank mode	Holds or blanks the display after measurements.
Backlight	Electroluminescent backlight, selectable as On or Auto On.
Receiver bandwidth	1 MHz to 18 MHz (-3 dB)
Metric/English mode	Metric or English units
Display languages	English, French, German, Spanish, Italian, Portuguese, Russian, Polish, and Swedish

9. Theory of Operation

The 27MG Ultrasonic Thickness Gauge operates on the dual transducer *pulse-echo* principal, timing the reflection of high-frequency sound waves from the back wall of the test piece. This technique, derived from sonar, has been widely applied to nondestructive testing.

The frequency range used by the gauge does not travel well through air, so a coupling liquid such as glycerine or gel is used between the face of the transducer and the test piece.

The sound waves generated by the transmit side of the transducer are coupled into the test piece, travel through it, and are reflected back from the opposite side.

The reflected sound waves or echoes are coupled into the receive side of the transducer where they are converted back into electrical signals.

The gauge precisely measures the time interval between the excitation pulse and the first echo signal and subtracts a zero offset value representing transducer delay. The result is multiplied by the velocity of sound in the test material, V , and divided by two to compensate for the two-way sound path. The final result, X , is the thickness of the test material.

$$X = \frac{(t)V}{2}$$

The microprocessor performs the arithmetic described above to produce the thickness value. This value, along with various gauge status indicators, is sent to the LCD display.

The microprocessor also directs the receiver/detector to identify the transducer type using the I.D. pin of the transducer. Calibration values and gauge setups are saved in non-volatile RAM (random access memory). The keyboard informs the microprocessor of user-entered changes of mode, values, and so on.

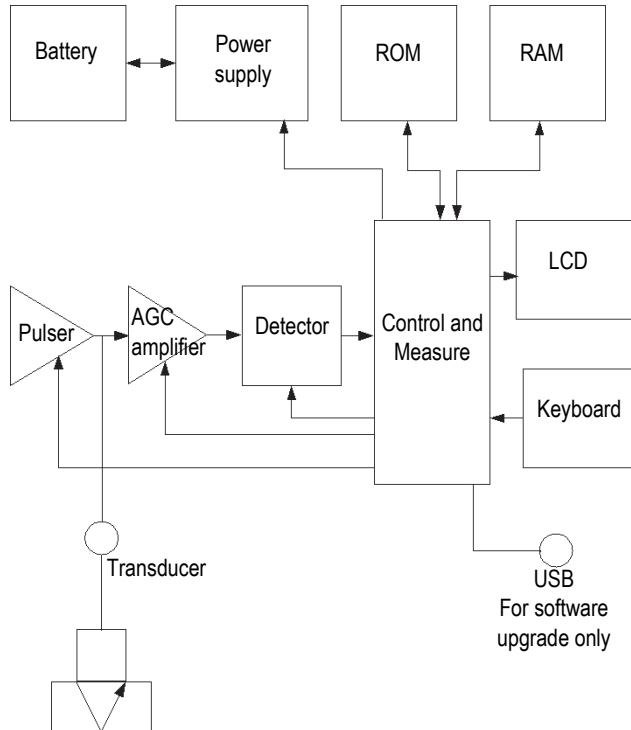

Figure 9-1 27MG block diagram

10. Application Notes

This chapter covers factors that can affect the performance and the accuracy of the 27MG Ultrasonic Thickness Gauge, the selection of transducers with regard to the minimum material thickness for valid measurements, and special considerations when measuring corrosion at elevated temperatures.

10.1 Factors Affecting Performance and Accuracy

The following factors can affect the performance and the accuracy of the 27MG Ultrasonic Thickness Gauge:

- **Surface Condition**

Severe pitting on the outside surface of a pipe or tank can be a problem. On some rough surfaces, the use of a gel or grease rather than a liquid couplant will help transmit sound energy into the test piece. In extreme cases, it will be necessary to file or grind the surface sufficiently flat to permit contact with the face of the transducer. In applications where deep pitting occurs on the outside of a pipe or tank it is usually necessary to measure remaining metal thickness from the base of the pits to the inside wall. The conventional technique is to measure unpitted metal thickness ultrasonically, measure pit depth mechanically, and subtract the pit depth from the measured wall thickness. Alternately, one can file or grind the surface down to the base of the pits and measure normally. As with any difficult application, experimentation with actual product samples is the best way to determine the limits of a particular gauge/transducer combination on a given surface.

- **Transducer Positioning/Alignment**

For proper sound coupling, the transducer must be pressed firmly against the test surface. On small diameter cylindrical surfaces such as pipes, hold the transducer

so that the sound barrier material visible on the probe face is aligned perpendicularly to the center axis of the pipe (see Figure 10-1 on page 70).



Figure 10-1 Perpendicular to center axis alignment on pipe

It is possible that on some severely corroded or pitted materials there will be spots where readings cannot be obtained. This can happen when the inside surface of the material is so irregular that the sound energy is scattered rather than being reflected back to the transducer. The lack of a reading may also indicate a thickness outside the range of the transducer and instrument being used. Generally, an inability to obtain a valid thickness reading at a particular point on a test specimen could be a sign of a seriously degraded wall, which may warrant investigation by other means.

- Calibration

The accuracy of measurements is only as good as the accuracy and care with which the gauge has been calibrated. It is essential that the velocity and zero calibrations be performed whenever the test material or transducer is changed. Periodic checks with samples of known thicknesses are recommended to verify that the gauge is operating properly.

- Taper or Eccentricity

If the contact surface and the back surface are tapered or eccentric with respect to each other, the return echo becomes distorted and the accuracy of measurement is diminished.

- Acoustic Properties of the Material

There are several conditions found in engineering materials that can severely limit the accuracy and thickness range that can be measured.

- Sound Scattering

Sound scattering in some materials (notably certain types of cast stainless steel, cast irons, and composites) occurs when sound energy is scattered from individual crystallites in the casting or from dissimilar materials within the composite. This effect reduces the ability to discriminate a valid return echo from the back wall of the material and limits the ability to measure the material ultrasonically.

- **Velocity Variations**
A number of materials exhibit significant variations in sound velocity from point-to-point within the material. Certain types of cast stainless steels and brass exhibit this effect due to a relatively large grain size and the anisotropy of sound velocity with respect to grain orientation. Other materials show a rapid change in sound velocity with variations in temperature. This is characteristic of plastic materials where temperature must be controlled in order to obtain maximum precision in the measurement.
- **Sound Attenuation**
Sound attenuation or absorption in many organic materials, such as low density plastics and rubber, occurs when sound is attenuated very rapidly at the frequencies used in normal ultrasonic thickness gaging. Therefore, the maximum thickness that can be measured in these materials is often limited.

10.2 Transducer Selection

For any ultrasonic measurement system (transducer plus thickness gauge), there is a minimum material thickness below which valid measurements will not be possible.

Normally this minimum range will be specified in the manufacturer's literature. As transducer frequency increases, the minimum measurable thickness decreases. In corrosion applications, where minimum remaining wall thickness is normally the parameter to be measured, it is particularly important to be aware of the specified range of the transducer being used. If a dual is used to measure a test piece that is below its designed minimum range, the gauge may detect invalid echoes and display an incorrectly high thickness reading.

Table 4 on page 72 lists approximate minimum measurable thicknesses in steel for the standard transducers used with the 27MG Ultrasonic Thickness Gauge. Note that these numbers are approximate. The exact measurable minimum in a given application depends on material velocity, surface condition, temperature, and geometry, and it should be determined experimentally by the user.

Table 4 Transducer selection

Probe	MHz	Connector	Tip diameter	Range (steel)	Temperature range
D7910	5.0	Right angle	12.7 mm (0.50 in.)	1 mm to 254 mm (0.040 in. to 10 in.)	0 °C to 50 °C (32 °F to 122 °F)
D790 D790-SM D790-RL D790-SL	5.0	Straight Straight Right angle Straight	11.0 mm (0.434 in.)	1 mm to 500 mm (0.040 in. to 20 in.)	-20 °C to 500 °C (-5 °F to 932 °F)
D791	5.0	Right angle	11.0 mm (0.434 in.)	1 mm to 500 mm (0.040 in. to 20 in.)	-20 °C to 500 °C (-5 °F to 932 °F)
D791-RM	5.0	Right angle	11.0 mm (0.434 in.)	1 mm to 500 mm (0.040 in. to 20 in.)	-20 °C to 400 °C (-5 °F to 752 °F)
D7912	10.0	Straight	7.5 mm (0.295 in.)	0.5 mm to 25 mm (0.020 in. to 1 in.)	0 °C to 50 °C (32 °F to 122 °F)
D7913	10.0	90 degree	7.5 mm (0.295 in.)	0.5 mm to 25 mm (0.020 in. to 1 in.)	0 °C to 50 °C (32 °F to 122 °F)
D797 D797-SM	2.0	Right angle Straight	22.9 mm (0.900 in.)	3.8 mm to 635 mm (0.150 in. to 25 in.)	-20 °C to 400 °C (-5 °F to 752 °F)

Table 4 Transducer selection (continued)

Probe	MHz	Connector	Tip diameter	Range (steel)	Temperature range
D7226 D798-LF	7.5	Right angle	8.9 mm (0.350 in.)	0.71 mm to 50 mm (0.028 in. to 2 in.)	-20 °C to 150 °C (-5 °F to 300 °F)
D798 D798-SM	7.5	Right angle Straight	7.2 mm (0.283 in.)	0.71 mm to 50 mm (0.028 in. to 2 in.)	-20 °C to 150 °C (-5 °F to 300 °F)
D799	5.0	Right angle	11.0 mm (0.434 in.)	1 mm to 500 mm (0.040 in. to 20 in.)	-20 °C to 150 °C (-5 °F to 300 °F)

In selecting a transducer for a corrosion application it is also necessary to consider the temperature of the material to be measured. Not all duals are designed for high temperature measurements. The chart above lists recommended temperature ranges for the duals used with the 27MG Ultrasonic Thickness Gauge. For other transducers, consult the manufacturer. Using a transducer on materials whose temperature is beyond the specified range can damage or destroy the transducer.

10.3 High Temperature Measurements

Corrosion measurements at elevated temperatures require special consideration. Keep in mind the following points:

- Be sure that the surface temperature of the test piece does not exceed the maximum specified temperature for the transducer and couplant that you are using. Some duals are designed for room temperature measurements only.
- Use a couplant rated for the temperature where you will be working. All high temperature couplants will boil off at some temperature, leaving a hard residue that is not able to transmit sound energy. Evident Couplant (H-2) can be used at temperatures up to 398 °C (750 °F), although it will boil as the upper limit is reached.

Maximum recommended temperatures for Evident couplants are provided in Table 5 on page 74.

Table 5 Couplant selection

Couplant	Type	Maximum recommended temperature
B	Glycerine	90 °C (200 °F)
D	Gel	90 °C (200 °F)
H-2	High Temperature	Up to 398 °C (750 °F)

NOTE

Not all types of couplant are available in every country due to local regulation. Consult your local Evident representative for a list of available couplants.

- Make measurements quickly and allow the transducer body to cool between readings. High temperature duals have delay lines made of thermally tolerant material, but with continuous exposure to very high temperatures the inside of the probe will heat to a point where the transducer will be permanently damaged.
- Remember that both material sound velocity and transducer zero offset will change with temperature.

For maximum accuracy at high temperatures, velocity calibration should be performed using a section of the test bar of known thickness heated to the temperature where measurements are to be performed. The 27MG Ultrasonic Thickness Gauge has a semiautomatic zero function that can be employed to adjust zero setting at high temperatures.

- Using the Fast mode with the Freeze function may help in obtaining measurements as quickly as possible.
- Note that a corrosion gauge is not designed for flaw or crack detection, and cannot be relied upon to detect material discontinuities. A proper evaluation of material discontinuities requires an ultrasonic flaw detector such as the EPOCH used by a properly trained operator. In general, unexplained readings by a corrosion gauge merit further testing with a flaw detector.

- For further information on the use of dual element transducers in corrosion gaging, or for information on any aspect of ultrasonic testing, contact Evident.
- Often, performance on hot, corroded materials will be considerably improved by the use of the Gain Adjust procedure or the Material Sensitivity Optimization procedure. High temperature couplants are generally less efficient than those used at lower temperatures, so the 27MG will work better when sensitivity is adjusted or optimized to accommodate high temperature conditions.

11. Maintenance and Troubleshooting

This chapter describes how to maintain your 27MG instrument by carrying out routine care and maintenance.

11.1 Routine Care and Maintenance

The 27MG case is sealed to prevent intrusion of environmental liquids and dust. However, it is not completely waterproof. Therefore, the unit should never be immersed in any fluid.

The case, keypad, and display window may be cleaned with a damp cloth and mild detergent if necessary. Do not use strong solvents or abrasives.

11.2 Transducers Maintenance

The ultrasonic transducers or probes used with the 27MG Ultrasonic Thickness Gauge are rugged devices that need little care. They are not indestructible, however, and a little attention to the following items will result in the longest transducer life:

- The cables can be damaged by cutting, pinching, or pulling. Care must be taken to prevent mechanical abuse to the cables. Never leave a transducer where a heavy object can be placed on the cable. Never remove a transducer from the gauge by pulling on the cable. Pull on the molded connector housing only. Never tie a knot in a transducer cable.
- Do not twist or pull the cable at the point where it connects to the transducer. These precautions are particularly important for all transducers other than the models that have field-replaceable cables.
- Transducer performance will be degraded by excessive wear at the tip. To minimize wear, do not scrape or drag the transducer across rough surfaces. When

a transducer tip becomes too rough, concave, or otherwise non-flat, operation may become erratic or impossible. Although some wear is normal in corrosion gaging applications, severe wear will limit transducer life. A transducer resurfacing procedure can be performed to improve performance of worn transducers. Contact Evident for details.

11.3 Error Messages

During the normal operation of the 27MG Ultrasonic Thickness Gauge, certain special error messages may be displayed. Usually these indicate a problem with the operating procedure but some may indicate a physical problem with the gauge itself. Consult Evident for further information.

11.4 Battery Problems

The bars on the batteries symbol show operating time remaining. If the 27MG Ultrasonic Thickness Gauge turns off immediately after it is turned on, or if it does not turn on at all, then the battery is probably completely discharged. The batteries should be replaced. If, after replacing the batteries, the unit still does not turn on, there has probably been a component failure within the gauge, which should be serviced.

11.5 Setup (Do--) Problems

If the message **Do--** will not go away when the **[ZERO]** key is pressed, make sure that an Evident transducer is plugged in. If so, the transducer may be defective. Try another one if possible, or try a different cable. If no transducers will permit the **Do--** message to be removed, there is probably a problem in the pulser/receiver assembly of the gauge.

11.6 Measurement Problems Diagnostic

If measurements cannot be made and the **MEAS** and **LOS** flags are on, then there is either a problem with the transducer or the pulser/receiver assembly, or there is not a large enough echo being returned from the back wall of the material.

To further diagnose the problem

1. Wipe off any couplant from the transducer and press [2nd F], [CAL ZERO]. If a number between 3000 and 7500 is displayed along with the **DO ZERO** flag, both the transducer and pulser/receiver assembly are working. Go to step 2. Otherwise go to step 6.
2. Make sure you have sufficient couplant, especially on rough or curved surfaces.
3. Try the same transducer on a smooth- and flat-surfaced test sample.
4. If the tests above all pass, but measurements still cannot be made, try changing the Gain Adjust or Material Sensitivity. If measurements still cannot be made, try a different type of transducer with greater sensitivity in the thickness range in which you are working.
5. If another transducer of the same type is available, use it to make measurements and to do step 1. If this works, then the original transducer is defective. Otherwise, the pulser/receiver assembly is probably defective.
6. If the above tests indicate that there is a problem with the gauge or transducer, then the unit(s) may be returned to Evident for repair or replacement. If the above tests indicate that the gauge and transducer are good, the test material itself probably cannot be measured due to:
 - Extreme near side or far side surface roughness
 - Extremely high sound attenuation or scattering caused by graininess, inclusions, voids, or other material properties
 - Extreme non-parallelism
 - Excessively sharp curvature

11.7 Self Diagnostics

The 27MG Ultrasonic Thickness Gauge includes two self-diagnostic (DIAG) screens that permit the user to identify hardware or software problems.

To view the Diagnostic 1 screen and see internal self-test results

1. Press [2nd F] [▼] (SETUP) to display the setup tabs.
2. Use the [◀, ▶] keys to highlight the **DIAG1** tab.
The results provided in Table 6 on page 80 are displayed.

Table 6 DIAG1 results

GAIN	Internal Calibration
BLK, DET, SMP	Internal Blank, Detector and Sampler Test
THRESH CAL (RCVR1)	Threshold Calibration Test Receiver 1
THRESH CAL (RCVR2)	Threshold Calibration Test Receiver 2

NOTE

Highlighted parameters indicate that the specific self-test failed based on the expected values.

To view the Diagnostic 2 screen, which shows information about your 27MG instrument

1. Press [2nd F] [▼] (SETUP) to display the setup tabs.
2. Use the [◀, ▶] keys to highlight the **DIAG2** tab.
The results provided in Table 7 on page 80 are displayed.

Table 7 DIAG2 results

SW REV	Reports software version (1.00/1.00G)
BATTERY	Indicates current battery voltage
PROBE	Indicates current attached probe
PR TX	Indicates the time of flight for the transmit delay line
PR RX	Indicates the time of flight for the receiver delay line

NOTE

If PR TX displays N/A, then either the cable is broken or there is a problem with the transducer.

11.8 Gauge Performance Tests

The 27MG Ultrasonic Thickness Gauge TESTS screen includes two test functions of gauge performance (see Figure 11-1 on page 81):

- **KEYPAD** - Tests keypad keys.
- **VIDEO** - Tests to assure that pixel locations are functional.

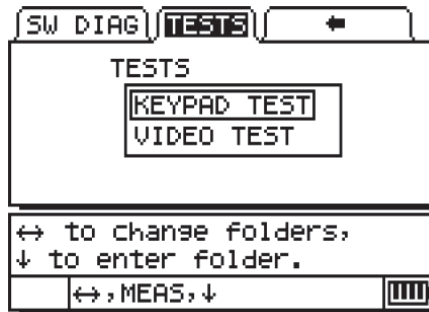

Figure 11-1 Tests screen

11.8.1 KEYPAD TEST

The Keypad Test function tests the keypad to assure that the keys are functional. Selecting **KEYPAD TEST** displays a virtual image of the keypad (see Figure 11-2 on page 82). To test each key, press the key on the keypad. The image of the key will be highlighted. Where mismatches occur, keys are not functional.

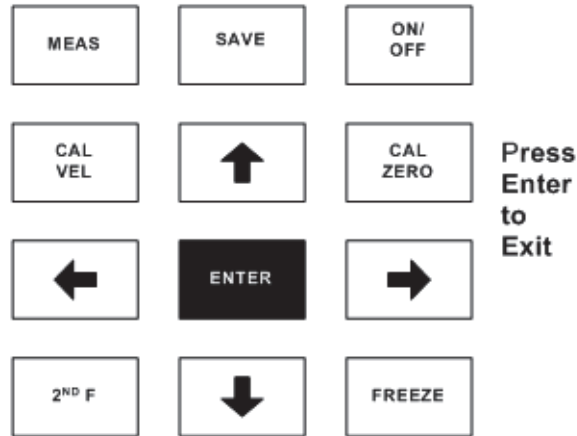

Figure 11-2 Keypad test

To test the keypad

1. From the measurement (**MEAS**) screen, press [**2nd F**] [**▼**] and use the [**▶**] arrow to move across the top of the screen to the **TESTS** tab.
2. Press the [**▼**] arrow to select **KEYPAD TEST** and then press [**ENTER**] to start the test, or press [**2nd F**] [**▲**] to abort the test. Visually determine that the keypad keys are functional.
3. Press [**ENTER**] to go back to the **TESTS** screen.

11.8.2 VIDEO TEST

The Video Test function tests the display to assure that individual pixels are functional (see Figure 11-3 on page 83). Non-functional pixels display in white when the **VIDEO TEST** is activated.

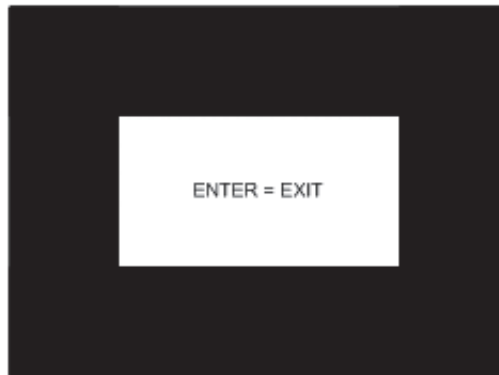

Figure 11-3 The Video Test screen

To test the video display

1. From the measurement (**MEAS**) screen, press [**2nd F**] [**▼**] and use the [**▶**] arrow to move across the top of the screen to the **TESTS** tab.
2. Press the [**▼**] arrow to select **VIDEO TEST** and then press [**ENTER**] to start the test, or press [**2nd F**] [**▲**] to abort the test. Determine visually that video pixels are functional by observing if white spots occur in the screen test display.
3. Press [**ENTER**] to go back to the **TESTS** screen.

11.9 Repair Service

Evident will repair any 27MG Ultrasonic Thickness Gauge at its Waltham, Massachusetts, USA factory. In addition, some local Evident dealers can perform repairs.

11.10 Replacement Parts, Optional Parts, and Equipment

Replacement parts for the 27MG as well as additional related equipment are available from Evident.

Appendix: Sound Velocities

Table 8 on page 85 presents a tabulation of the ultrasonic velocity in a variety of common materials. It is provided only as a guide. The actual velocity in these materials may vary significantly for a variety of reasons, such as: composition, preferred crystallographic orientation, porosity, and temperature. Therefore, for maximum accuracy, establish the sound velocity in a given material by first testing a sample of the material.

Table 8 Ultrasonic velocities

Material	V (in./ μ s)	V (m/s)
Acrylic resin (Perspex)	0.107	2730
Aluminum	0.249	6320
Beryllium	0.508	12900
Brass, naval	0.174	4430
Copper	0.183	4660
Diamond	0.709	18000
Glycerin	0.076	1920
Inconel	0.229	5820
Iron, Cast (slow)	0.138	3500
Iron, Cast (fast)	0.220	5600
Iron oxide (magnetite)	0.232	5890
Lead	0.085	2160

Table 8 Ultrasonic velocities (continued)

Material	V (in./μs)	V (m/s)
Lucite	0.106	2680
Molybdenum	0.246	6250
Motor oil (SAE 20/30)	0.069	1740
Nickel, pure	0.222	5630
Polyamide (slow)	0.087	2200
Nylon, fast	0.102	2600
Polyethylene, high density (HDPE)	0.097	2460
Polyethylene, low density (LDPE)	0.082	2080
Polystyrene	0.092	2340
Polyvinylchloride, (PVC, hard)	0.094	2395
Rubber (polybutadiene)	0.063	1610
Silicon	0.379	9620
Silicone	0.058	1485
Steel, 1020	0.232	5890
Steel, 4340	0.230	5850
Steel, 302 austenitic stainless	0.223	5660
Steel, 347 austenitic stainless	0.226	5740
Tin	0.131	3320
Titanium, Ti 150A	0.240	6100

Table 8 Ultrasonic velocities (continued)

Material	V (in./ μ s)	V (m/s)
Tungsten	0.204	5180
Water (20 °C [68 °F])	0.0580	1480
Zinc	0.164	4170
Zirconium	0.183	4650

References

1. W.P. Mason, *Physical Acoustics and the Properties of Solids*, D. Van Nostrand Co., New York, 1958.
2. E.P. Papadakis, Panametrics - unpublished notes, 1972.
3. J.R. Fredericks, *Ultrasonic Engineering*, John Wiley & Sons, Inc., New York, 1965.
4. D. L. Folds, "Experimental Determination of Ultrasonic Wave Velocities in Plastics, Elastomers, and Syntactic Foam as a Function of Temperature", Naval Research and Development Laboratory, Panama City, Florida, 1971.
5. *Handbook of Chemistry and Physics*, Chemical Rubber Co., Cleveland, Ohio, 1963.

List of Figures

Figure 1-1	The 27MG hardware components — Front and top views	25
Figure 1-2	The 27MG connections	25
Figure 1-3	The top end connectors	26
Figure 1-4	The 27MG keypads	26
Figure 2-1	The power indicator when using batteries	31
Figure 2-2	Opening the battery compartment	33
Figure 2-3	Selecting the battery type	34
Figure 3-1	The measurement screen	35
Figure 3-2	Other elements of the measurement screen	36
Figure 3-3	Parameter screen example	37
Figure 4-1	Transducer zero compensation	40
Figure 4-2	The Zero screen	41
Figure 5-1	The Do-- screen	44
Figure 5-2	The unknown sound material Do-- screen	46
Figure 9-1	27MG block diagram	68
Figure 10-1	Perpendicular to center axis alignment on pipe	70
Figure 11-1	Tests screen	81
Figure 11-2	Keypad test	82
Figure 11-3	The Video Test screen	83

List of Tables

Table 1	Keypad functions	27
Table 2	Default conditions	39
Table 3	Specifications	65
Table 4	Transducer selection	72
Table 5	Couplant selection	74
Table 6	DIAG1 results	80
Table 7	DIAG2 results	80
Table 8	Ultrasonic velocities	85

