



# EPOCH 650

## Ultrasonic Flaw Detector

### User's Manual

DMTA-10055-01EN — Rev. D  
May 2023

This instruction manual contains essential information on how to use this Evident product safely and effectively. Before using this product, thoroughly review this instruction manual. Use the product as instructed. Keep this instruction manual in a safe, accessible location.

EVIDENT SCIENTIFIC, INC., 48 Woerd Avenue, Waltham, MA 02453, USA

Copyright © 2022, 2023 by Evident. All rights reserved. No part of this publication may be reproduced, translated, or distributed without the express written permission of Evident.

This document was prepared with particular attention to usage to ensure the accuracy of the information contained therein, and corresponds to the version of the product manufactured prior to the date appearing on the title page. There could, however, be some differences between the manual and the product if the product was modified thereafter.

The information contained in this document is subject to change without notice.

Part number: DMTA-10055-01EN

Rev. D

May 2023

Printed in the United States of America

SD, miniSD, and microSD Logos are trademarks of SD-3C, LLC.

All brands are trademarks or registered trademarks of their respective owners and third party entities.

---

---

# Table of Contents

---

<b>List of Abbreviations .....</b>	<b>11</b>
<b>Important Information – Please Read Before Use .....</b>	<b>13</b>
Intended Use .....	13
Instruction Manual .....	13
Device Compatibility .....	14
Repair and Modification .....	14
Safety Symbols .....	14
Safety Signal Words .....	15
Note Signal Words .....	16
Safety .....	16
Warnings .....	16
Battery Precautions .....	17
Regulations for Shipping Products with Lithium-Ion Batteries .....	19
Equipment Disposal .....	19
BC (Battery Charger - California, USA Community) .....	19
CE (European Conformity) .....	20
UKCA (United Kingdom) .....	20
RCM (Australia) .....	20
WEEE Directive .....	20
China RoHS .....	21
Korea Communications Commission (KCC) .....	22
EMC Directive Compliance .....	22
FCC (USA) Compliance .....	23
ICES-001 (Canada) Compliance .....	24
Warranty Information .....	24
Technical Support .....	25
<b>Introduction .....</b>	<b>27</b>
Package Content .....	28

---

<b>1. Hardware Overview .....</b>	<b>31</b>
1.1 Front Panel .....	32
1.1.1 Adjustment Knob Configuration .....	34
1.1.2 Navigation Pad Configuration .....	37
1.1.3 Direct-Access Keys .....	40
1.1.4 Function and Parameter Keys .....	42
1.1.5 Power Indicator .....	44
1.1.6 Alarm Indicators .....	44
1.2 Connectors .....	45
1.2.1 Transducer Connectors .....	45
1.2.2 Digital Out Connector .....	46
1.2.2.1 Alarm Output Connector Pins .....	47
1.2.2.2 Serial Communication Pins .....	47
1.2.2.3 Encoder Input Pins .....	47
1.2.2.4 Trigger Input and Output Pins .....	48
1.2.3 VGA Out Connector .....	48
1.2.4 USB Client Port and microSD Card Slot .....	49
1.2.4.1 USB Client Port .....	50
1.2.4.2 microSD Card Slot .....	51
1.3 Battery Compartment .....	52
1.4 Instrument Stand .....	53
<b>2. Powering the EPOCH 650 .....</b>	<b>55</b>
2.1 Lithium-Ion Battery .....	56
2.2 AC Charger/Adaptor .....	57
2.3 Standalone Battery Charger .....	59
2.4 Power Status Indicators .....	59
<b>3. Software Overview .....</b>	<b>61</b>
3.1 Choosing a Function Menu Item .....	62
3.2 Parameter Selection .....	63
3.3 Convention for Identifying Menu Items and Parameters .....	64
3.4 Parameter Adjustment .....	64
3.5 Escape Key .....	65
3.6 Lock Key .....	65
3.7 AUTO XX% Feature .....	66
3.8 Submenus .....	66
3.9 Pulser and Receiver Settings .....	67
3.9.1 Sensitivity .....	67
3.9.2 Reference Gain .....	67
3.9.3 Pulser .....	68

3.9.4	Receiver .....	68
3.10	Gates .....	70
3.10.1	Quickly Adjusting Basic Gate Parameters .....	70
3.10.2	Gate 1 and Gate 2 .....	71
3.10.3	Gate Setup .....	71
3.10.4	Gate Alarm Indications .....	73
3.11	Calibration .....	74
3.11.1	Measurement calibration .....	74
3.11.2	Angle Beam Calibration .....	79
3.12	Data Logger .....	80
3.12.1	Calibration Files .....	80
3.12.2	Resetting the Instrument .....	82
<b>4.</b>	<b>Software Interface .....</b>	<b>85</b>
4.1	Button Types .....	86
4.2	File Identifier and Message Bars .....	87
4.3	Direct-Access Parameters .....	88
4.4	Measurement Reading Boxes .....	89
4.5	Live-Scan Area .....	90
4.6	Flags .....	90
4.7	Menu Contents .....	94
4.8	Setup Pages .....	98
4.8.1	Entering an Alphanumeric Value Using the Virtual Keyboard .....	99
4.8.2	Display Setup Page .....	101
4.8.3	Grid Setup Page .....	103
4.8.4	Reading Setup Page .....	103
4.8.5	General Setup Page .....	107
4.8.6	About Page .....	110
4.8.7	Clock Setup Page .....	111
4.8.8	Software Options Setup Page .....	112
4.8.9	Misc Setup Page .....	112
4.8.10	Editable Parameters Page .....	114
4.8.11	Analog Output Setup Page .....	116
<b>5.</b>	<b>Adjusting the Pulser/Receiver .....</b>	<b>117</b>
5.1	Adjusting the System Sensitivity (Gain) .....	117
5.2	Using the AUTO XX% Feature .....	117
5.3	Setting Reference Gain and Scanning Gain .....	118
5.4	Pulser Adjustments .....	119
5.4.1	Pulse Repetition Frequency (PRF) .....	119
5.4.2	Pulse Energy (Voltage) .....	120

5.4.3	Damping .....	121
5.4.4	Test Mode .....	121
5.4.5	Pulser Type .....	122
5.4.6	Pulser Frequency Selection (Pulse Width) .....	123
5.5	Receiver Adjustments .....	123
5.5.1	Digital Receiver Filters .....	123
5.5.2	Waveform Rectification .....	125
<b>6.</b>	<b>Managing Special Waveform Functions .....</b>	<b>127</b>
6.1	Reject .....	127
6.2	Peak Memory .....	128
6.3	Peak Hold .....	130
6.4	Freeze .....	130
6.5	Grid Modes .....	131
6.6	Baseline Break .....	134
<b>7.</b>	<b>Gates .....</b>	<b>135</b>
7.1	Measurement Gates 1 and 2 .....	135
7.2	Quickly Adjusting Basic Gate Parameters .....	137
7.3	Gate Measurement Modes .....	138
7.4	Viewing Measurement Readings .....	142
7.5	Gate Tracking and Echo-to-Echo Measurements .....	142
7.6	Operating in Time-of-Flight Mode .....	144
7.7	Zooming on a Gate .....	144
7.8	Gate Alarms .....	145
7.8.1	Threshold Alarms .....	145
7.8.2	Minimum Depth Alarm .....	146
7.8.3	Minimum Depth Alarm with a Single Gate .....	146
7.8.4	Minimum Depth Alarm with Gate Tracking .....	147
<b>8.</b>	<b>Programmable Inputs and Outputs .....</b>	<b>149</b>
8.1	Alarm Outputs .....	149
8.2	Serial/USB Command Protocol .....	149
8.3	Trigger Inputs and Outputs .....	150
8.4	Encoder Inputs .....	151
8.5	Analog Output .....	151
<b>9.</b>	<b>Calibration .....</b>	<b>155</b>
9.1	Basic Setup .....	155
9.2	Calibration Modes .....	156
9.2.1	Straight Beam Modes .....	157

9.2.2	Angle Beam Modes .....	157
9.3	Calibrating with a Straight Beam Transducer .....	158
9.4	Calibrating with a Delay Line Transducer .....	162
9.5	Calibrating on a Single Test Block of Known Thickness .....	168
9.6	Calibrating with a Dual Element Transducer .....	168
9.7	Calibrating in Echo-to-Echo Mode .....	173
9.8	Calibrating to Known Sound Path Values with an Angle Beam Transducer .....	177
9.8.1	Locating the Beam Index Point .....	177
9.8.2	Verifying the Refracted Angle .....	179
9.8.3	Calibrating for Distance .....	181
9.8.4	Calibrating for Sensitivity .....	185
9.9	Calibrating to Known Depth Values with an Angle Beam Transducer .....	187
9.10	Curved Surface Correction .....	192
9.11	Common Angle Beam Calibration Block Diagrams .....	193
<b>10.</b>	<b>Data Logger .....</b>	<b>199</b>
10.1	Data File Types .....	200
10.1.1	Calibration file type .....	200
10.1.2	Incremental file type .....	200
10.1.3	Advanced File Types .....	200
10.1.3.1	Sequential .....	201
10.1.3.2	Sequential with Custom Points .....	201
10.1.3.3	2-D Matrix Grid .....	201
10.1.3.4	2-D EPRI .....	201
10.1.3.5	2-D Matrix Grid with Custom Point .....	201
10.1.3.6	3-D Matrix Grid .....	201
10.1.3.7	Boiler .....	202
10.2	Data Logger Storage Capacity .....	202
10.3	Saving Data to Files .....	202
10.4	Data Logger Menus .....	203
10.4.1	File Menu .....	203
10.4.1.1	Create .....	204
10.4.1.2	Open .....	209
10.4.1.3	Quick Recall .....	216
10.4.1.4	Memo .....	217
10.4.1.5	Last ID and Select ID .....	219
10.4.2	Manage Menu .....	220
10.4.2.1	Reset .....	221
10.4.2.2	Export .....	222
10.4.2.3	Import .....	223
10.4.2.4	Edit .....	225
10.4.2.5	Copy .....	226

10.4.2.6	Delete .....	227
10.4.2.7	Import Memo .....	228
10.5	Grid View .....	229
10.5.1	Activating Grid View .....	229
10.5.2	Configuring the Grid View .....	229
10.5.3	Using the Grid .....	230
10.6	Screen Capture .....	233
10.7	Video Record .....	233
10.7.1	Activating the video recorder .....	233
10.7.2	Using the video recorder .....	233
<b>11.</b>	<b>Software Features and Options .....</b>	<b>237</b>
11.1	Defining Licensed and Unlicensed Software Features .....	237
11.2	Dynamic DAC/TCG .....	238
11.2.1	Feature Activation and Reference Correct .....	239
11.2.2	Standard/ASME III DAC/TCG .....	241
11.2.3	Gain Adjustment Options .....	246
11.2.3.1	Scanning Gain .....	246
11.2.3.2	Curve Adjustment Gain (DAC Gain or TCG Gain) .....	248
11.2.3.3	Transfer Correction .....	249
11.2.4	JIS DAC .....	250
11.2.5	Custom DAC Curves .....	250
11.3	DGS/AVG .....	252
11.3.1	Option Activation and Setup .....	253
11.3.2	Curve Adjustment Options .....	258
11.3.3	Transfer Correction .....	258
11.3.4	DGS/AVG Curve Gain .....	259
11.3.5	Registration Level Adjustment .....	260
11.3.6	Relative Attenuation Measurement .....	261
11.4	AWS D1.1/D1.5 Weld Rating Software .....	261
11.4.1	Activating the AWS D1.1 software option .....	262
11.4.2	Adjusting the AWS Reference Level .....	263
11.4.3	Storing the Gated Reflector .....	264
11.4.4	Scanning Gain .....	265
11.4.5	Calculating A and C Values .....	266
11.5	API 5UE .....	266
11.5.1	Option Activation and Setup .....	268
11.5.2	Envelope Mode .....	270
11.5.2.1	Envelope Mode Calibration .....	270
11.5.2.2	Crack Sizing .....	271
11.5.3	Manual Mode .....	273
11.5.3.1	Manual Mode Calibration .....	273



11.5.3.2	Crack Sizing .....	276
11.6	Waveform Averaging .....	277
11.6.1	Waveform Averaging Setup .....	278
11.6.2	Using Waveform Averaging .....	278
11.7	Back Wall Echo Attenuator .....	280
11.8	Interface Gate .....	283
11.8.1	Activating the Interface Gate .....	283
11.8.2	Adjusting the interface gate .....	283
11.8.3	Setting the Material Velocity .....	284
11.8.4	Using Run Mode .....	284
11.8.5	Interface Gate Compatibility .....	286
11.8.6	Gate Measurements and Alarms .....	287
11.9	Corrosion Module .....	287
11.9.1	Key Features .....	287
11.9.2	Corrosion Module Screen .....	288
11.9.3	Corrosion Module Activation and Setup .....	290
11.9.4	Basic Measurement Adjustments .....	292
11.9.4.1	Rectification .....	292
11.9.4.2	Extended Blank Control .....	292
11.9.4.3	Manual Gain Adjustment .....	293
11.9.5	Calibration for Additional Accuracy .....	295
11.9.6	Echo-to-Echo Measurements .....	295
11.9.7	B-Scan .....	297
11.9.7.1	Activating the B-Scan .....	298
11.9.7.2	B-Scan Setup Page .....	299
11.9.7.3	B-Scan Acquisition and Control .....	301
11.9.7.4	Viewing the B-Scan in the Data Logger .....	302
11.10	Template Storage .....	304
<b>12.</b>	<b>Maintenance and Troubleshooting .....</b>	<b>309</b>
12.1	Replacing the Battery .....	309
12.2	Instrument Cleaning .....	310
12.3	Verifying O-Ring Gaskets and Seals .....	310
12.4	Protecting the Display .....	311
12.5	Annual Calibration .....	311
12.6	Troubleshooting .....	311
<b>13.</b>	<b>Specifications .....</b>	<b>313</b>
13.1	General and Environmental Specifications .....	313
13.2	Channel Specifications .....	315
13.3	Input/Output Specifications .....	317

<b>Appendix A: Sound Velocities .....</b>	<b>319</b>
<b>Appendix B: Data File Types .....</b>	<b>321</b>
B.1 Calibration file type .....	321
B.2 Incremental file type .....	321
B.3 Advanced File Types .....	324
B.3.1 Sequential .....	324
B.3.2 2-D Matrix Grid .....	326
B.3.3 2-D EPRI .....	330
B.3.4 2-D Matrix Grid with Custom Point .....	330
B.3.5 3-D Matrix Grid .....	331
B.3.6 Boiler .....	332
<b>Appendix C: Glossary .....</b>	<b>333</b>
<b>Appendix D: Parts List .....</b>	<b>343</b>
<b>List of Figures .....</b>	<b>347</b>
<b>List of Tables .....</b>	<b>353</b>

---

## List of Abbreviations

---

AC	alternating current
ACT	amplitude comparison technique
ADDT	amplitude-distance differential technique
AGC	automatic gain compensation
API	American Petroleum Institute
ASME	American Society of Mechanical Engineers
AVG	abstand verstärkung grÖÙe
AWS	American Welding Society
BEA	back wall echo attenuator
BIP	beam index point
CSC	curved surface correction
DAC	distance amplitude correction
DC	direct current
DGS	distance gain size
EFUP	environment-friendly use period
FSH	full-screen height
ID	identifier
IF	interface gate
IIW	International Institute of Welding
JIS	Japanese Industrial Standard
LCD	liquid crystal display
MEM	memory
NDT	non-destructive testing
OS	overshoot
PK	peak
PRF	pulse repetition frequency
SDH	side-drilled hole
TCG	time-corrected gain
Trig	trigonometry
USB	universal serial bus
VGA	video graphics adapter



---

## Important Information — Please Read Before Use

---

### Intended Use

The EPOCH 650 is designed to perform nondestructive inspections on industrial and commercial materials.



#### **WARNING**

Do not use the EPOCH 650 for any purpose other than its intended use. It must never be used to inspect or examine human or animal body parts.

---

### Instruction Manual

This instruction manual contains essential information on how to use this product safely and effectively. Before using this product, thoroughly review this instruction manual. Use the product as instructed. Keep this instruction manual in a safe, accessible location.

---

#### **IMPORTANT**

Some of the details of components illustrated in this manual may differ from the components installed on your device. However, the operating principles remain the same.

---

## Device Compatibility

Only use this device with the approved ancillary equipment provided by Evident. Equipment provided by Evident and approved for use with this device is described later in this manual.

---



### CAUTION

Always use equipment and accessories that meet Evident specifications. Using incompatible equipment could cause equipment malfunction and/or damage, or human injury.

---

## Repair and Modification

This device does not contain any user-serviceable parts. Opening the device might void the warranty.

---



### CAUTION

In order to prevent human injury and/or equipment damage, do not disassemble, modify, or attempt to repair the device.

---

## Safety Symbols

The following safety symbols might appear on the device and in the instruction manual:



General warning symbol

This symbol is used to alert the user to potential hazards. All safety messages that follow this symbol shall be obeyed to avoid possible harm or material damage.

---



High voltage warning symbol

This symbol is used to alert the user to potential electric shock hazards greater than 1000 volts. All safety messages that follow this symbol shall be obeyed to avoid possible harm.

## Safety Signal Words

The following safety symbols might appear in the documentation of the device:



**DANGER**

The DANGER signal word indicates an imminently hazardous situation. It calls attention to a procedure, practice, or the like, which, if not correctly performed or adhered to, will result in death or serious personal injury. Do not proceed beyond a DANGER signal word until the indicated conditions are fully understood and met.



**WARNING**

The WARNING signal word indicates a potentially hazardous situation. It calls attention to a procedure, practice, or the like, which, if not correctly performed or adhered to, could result in death or serious personal injury. Do not proceed beyond a WARNING signal word until the indicated conditions are fully understood and met.



**CAUTION**

The CAUTION signal word indicates a potentially hazardous situation. It calls attention to an operating procedure, practice, or the like, which, if not correctly performed or adhered to, may result in minor or moderate personal injury, material damage, particularly to the product, destruction of part or all of the product, or loss of data. Do not proceed beyond a CAUTION signal word until the indicated conditions are fully understood and met.

## Note Signal Words

The following note signal words could appear in the documentation of the device:

**IMPORTANT**

The IMPORTANT signal word calls attention to a note that provides important information, or information essential to the completion of a task.

**NOTE**

The NOTE signal word calls attention to an operating procedure, practice, or the like, which requires special attention. A note also denotes related parenthetical information that is useful, but not imperative.

**TIP**

The TIP signal word calls attention to a type of note that helps you apply the techniques and procedures described in the manual to your specific needs, or provides hints on how to effectively use the capabilities of the product.

## Safety

Before turning on the device, verify that the correct safety precautions have been taken (see the following warnings). In addition, note the external markings on the device, which are described under “Safety Symbols.”

## Warnings



**WARNING**

### General Warnings

- Carefully read the instructions contained in this instruction manual prior to turning on the device.
- Keep this instruction manual in a safe place for further reference.



- Follow the installation and operation procedures.
- It is imperative to respect the safety warnings on the device and in this instruction manual.
- If the equipment is used in a manner not specified by the manufacturer, the protection provided by the equipment could be impaired.
- Do not install substitute parts or perform any unauthorized modification to the device.
- Service instructions, when applicable, are for trained service personnel. To avoid the risk of electric shock, do not perform any work on the device unless qualified to do so. For any problem or question regarding this device, contact Evident or an authorized Evident representative.
- Do not touch the connectors directly by hand. Otherwise, a malfunction or electric shock may result.
- Do not allow metallic or foreign objects to enter the device through connectors or any other openings. Otherwise, a malfunction or electric shock may result.

**WARNING****Electrical Warning**

The device must only be connected to a power source corresponding to the type indicated on the rating label.

**CAUTION**

If a non-approved power supply cord not dedicated to Evident products is used, Evident will not be able to ensure the electrical safety of the equipment.

**Battery Precautions****CAUTION**

- Before disposing of a battery, check your local laws, rules, and regulations, and follow them accordingly.

- Transportation of lithium-ion batteries is regulated by the United Nations under the United Nations Recommendations on the Transport of Dangerous Goods. It is expected that governments, intergovernmental organizations, and other international organizations shall conform to the principles laid down in these regulations, thus contributing to worldwide harmonization in this field. These international organizations include the International Civil Aviation organization (ICAO), the International Air Transport Association (IATA), the International Maritime Organization (IMO), the US Department of Transportation (USDOT), Transport Canada (TC), and others. Please contact the transporter and confirm current regulations before transportation of lithium-ion batteries.
- For California (USA) only:  
The device may contain a CR battery. The CR battery contains perchlorate material, and special handling may be required. Refer to <http://www.dtsc.ca.gov/hazardouswaste/perchlorate>.
- Do not open, crush, or perforate batteries; doing so could cause injury.
- Do not incinerate batteries. Keep batteries away from fire and other sources of extreme heat. Exposing batteries to extreme heat (over 80 °C) could result in an explosion or personal injury.
- Do not drop, hit, or otherwise abuse a battery, as doing so could expose the cell contents, which are corrosive and explosive.
- Do not short-circuit the battery terminals. A short circuit could cause injury and severe damage to a battery making it unusable.
- Do not expose a battery to moisture or rain; doing so could cause an electric shock.
- Only use the EPOCH 650 unit with an external charger approved by Evident to charge the batteries.
- Only use batteries supplied by Evident.
- Do not store batteries that have less than 40 % remaining charge. Recharge batteries to between 40 % and 80 % capacity before storing them.
- During storage, keep the battery charge between 40 % and 80 %.
- Do not leave batteries in the EPOCH 650 unit during device storage.

---

## Regulations for Shipping Products with Lithium-Ion Batteries

---

**IMPORTANT**

When shipping a Li-ion battery or batteries, be sure to follow all local transportation regulations.

---

**WARNING**

Damaged batteries cannot be shipped through normal routes — DO NOT ship damaged batteries to Evident. Contact your local Evident representative or material disposal professionals.

---

## Equipment Disposal

Before disposing of the EPOCH 650, check your local laws, rules, and regulations, and follow them accordingly.

## BC (Battery Charger - California, USA Community)



The BC marking indicates that this product has been tested and complies with the Appliance Efficiency Regulations as stated in the California Code of Regulations Title 20, Sections 1601 through 1608 for Battery Charger Systems. The internal battery charger within this device has been tested and certified pursuant to the California Energy Commission's (CEC) requirements; this device is listed on the online CEC's (T20) database.

## CE (European Conformity)



This device complies with the requirements of directive 2014/30/EU concerning electromagnetic compatibility, directive 2014/35/EU concerning low voltage, and directive 2015/863 which amends 2011/65/EU concerning restriction of hazardous substances (RoHS). The CE marking is a declaration that this product conforms to all the applicable directives of the European Community.

## UKCA (United Kingdom)



This device complies with the requirements of the Electromagnetic Compatibility Regulations 2016, the Electrical Equipment (Safety) Regulations 2016, and the Restriction of the Use of Certain Hazardous Substances in Electrical and Electronic Equipment Regulations 2012. The UKCA marking indicates compliance with the above regulations.

## RCM (Australia)



The regulatory compliance mark (RCM) label indicates that the product complies with all applicable standards, and has been registered with the Australian Communications and Media Authority (ACMA) for placement on the Australian market.

## WEEE Directive



In accordance with European Directive 2012/19/EU on Waste Electrical and Electronic Equipment (WEEE), this symbol indicates that the product must not be disposed of as unsorted municipal waste, but should be collected separately. Refer to your local Evident distributor for return and/or collection systems available in your country.



## China RoHS

*China RoHS* is the term used by industry generally to describe legislation implemented by the Ministry of Information Industry (MII) in the People's Republic of China for the control of pollution by electronic information products (EIP).



The China RoHS mark indicates the product's Environment-Friendly Use Period (EFUP). The EFUP is defined as the number of years for which listed controlled substances will not leak or chemically deteriorate while in the product. The EFUP for the EPOCH 650 has been determined to be 15 years.

**Note:** The Environment-Friendly Use Period (EFUP) is not meant to be interpreted as the period assuring functionality and product performance.



电器电子产品有害  
物质限制使用  
标志

本标志是根据“电器电子产品有害物质限制使用管理办法”以及“电子电气产品有害物质限制使用标识要求”的规定，适用于在中国销售的电器电子产品上的电器电子产品有害物质使用限制标志。

（注意）电器电子产品有害物质限制使用标志内的数字为在正常的使用条件下有害物质等不泄漏的期限，不是保证产品功能性能的期间。

产品中有害物质的名称及含量

部件名称		有害物质					
		铅及其化合物 (Pb)	汞及其化合物 (Hg)	镉及其化合物 (Cd)	六价铬及其化合物 (Cr( VI ))	多溴联苯 (PBB)	多溴二苯醚 (PBDE)
主体	机构部件	×	○	○	○	○	○
	光学部件	×	○	○	○	○	○
	电气部件	×	○	○	○	○	○

产品中有害物质的名称及含量

部件名称	有害物质					
	铅及其化合物 (Pb)	汞及其化合物 (Hg)	镉及其化合物 (Cd)	六价铬及其化合物 (Cr(VI))	多溴联苯 (PBB)	多溴二苯醚 (PBDE)
附件	×	○	○	○	○	○
本表格依据 SJ/T 11364 的规定编制。 ○：表示该有害物质在该部件所有均质材料中的含量均在 GB/T26572 规定的限量要求以下。 ×：表示该有害物质至少在该部件的某一均质材料中的含量超出 GB/T26572 规定的限量要求。						

## Korea Communications Commission (KCC)



Seller and user shall be noticed that this equipment is suitable for electromagnetic equipment for office work (class A) and it can be used outside the home. This device complies with the EMC requirements of Korea.

The MSIP code for the device is the following: MSIP-REM-OYN-EP650.

이 기기는 업무용 환경에서 사용할 목적으로 적합성평가를 받은 기기로서 가정용 환경에서 사용하는 경우 전파간섭의 우려가 있습니다.

## EMC Directive Compliance

This equipment generates and uses radio-frequency energy and, if not installed and used properly (that is, in strict accordance with the manufacturer's instructions), may cause interference. The EPOCH 650 has been tested and found to comply with the limits for an industrial device in accordance with the specifications of the EMC directive.

---

## FCC (USA) Compliance

---

<b>NOTE</b>
-------------

This product has been tested and found to comply with the limits for a Class A digital device, pursuant to Part 15 of the FCC Rules. These limits are designed to provide reasonable protection against harmful interference when the product is operated in a commercial environment. This product generates, uses, and can radiate radio frequency energy, and if not installed and used in accordance with the instruction manual, might cause harmful interference to radio communications. Operation of this product in a residential area is likely to cause harmful interference, in which case you will be required to correct the interference at your own expense.

---

---

<b>IMPORTANT</b>
------------------

Changes or modifications not expressly approved by the party responsible for compliance could void the user's authority to operate the product.

---

### FCC Supplier's Declaration of Conformity

Hereby declares that the product,

Product name: EPOCH 650

Model: EPOCH 650-MR/ EPOCH 650-CW

Conforms to the following specifications:

FCC Part 15, Subpart B, Section 15.107 and Section 15.109.

Supplementary information:

This device complies with Part 15 of the FCC Rules. Operation is subject to the following two conditions:

- (1) This device may not cause harmful interference.
- (2) This device must accept any interference received, including interference that may cause undesired operation.

Responsible party name:

EVIDENT SCIENTIFIC, INC.

Address:

48 Woerd Avenue, Waltham, MA 02453, USA

Phone number:

+1 781-419-3900

## ICES-001 (Canada) Compliance

This Class A digital apparatus complies with Canadian ICES-001.

Cet appareil numérique de la classe A est conforme à la norme NMB-001 du Canada.

## Warranty Information

Evident guarantees your Evident product to be free from defects in materials and workmanship for a specific period, and in accordance with conditions specified in the Terms and Conditions available at <https://evidentscientific.com/evident-terms/>.

The Evident warranty only covers equipment that has been used in a proper manner, as described in this instruction manual, and that has not been subjected to excessive abuse, attempted unauthorized repair, or modification.

Inspect materials thoroughly on receipt for evidence of external or internal damage that might have occurred during shipment. Immediately notify the carrier making the delivery of any damage, because the carrier is normally liable for damage during shipment. Retain packing materials, waybills, and other shipping documentation needed in order to file a damage claim. After notifying the carrier, contact Evident for assistance with the damage claim and equipment replacement, if necessary.

This instruction manual explains the proper operation of your Evident product. The information contained herein is intended solely as a teaching aid, and shall not be used in any particular application without independent testing and/or verification by the operator or the supervisor. Such independent verification of procedures becomes increasingly important as the criticality of the application increases. For this reason, Evident makes no warranty, expressed or implied, that the techniques, examples, or procedures described herein are consistent with industry standards, nor that they meet the requirements of any particular application.



Evident reserves the right to modify any product without incurring the responsibility for modifying previously manufactured products.

## **Technical Support**

Evident is firmly committed to providing the highest level of customer service and product support. If you experience any difficulties when using our product, or if it fails to operate as described in the documentation, first consult the user's manual, and then, if you are still in need of assistance, contact our After-Sales Service. To locate the nearest service center, visit <https://www.evidentscientific.com/service-and-support/service-centers/>.



---

# Introduction

---

The EPOCH 650 is a portable ultrasonic nondestructive test (NDT) instrument used to detect flaw conditions in welds, pipes, and many other structural and/or industrial materials. The instrument may be used in indoor and outdoor environments. This flaw detector offers advanced conventional ultrasonic performance. The instrument features a large dynamic range, superior measurement resolution, a full VGA resolution (640 × 480 pixels) color-liquid crystal display with transfective technology for superior visibility, and an intuitive user interface.

The EPOCH 650 features many performance, durability, and operational enhancements when compared to previous EPOCH flaw detectors. These enhancements include:

- Case sealed to the requirements of IP66 (adjustment knob configuration) or IP67 (navigation pad configuration) environmental rating
- Color liquid crystal display (LCD) with full VGA resolution and transfective technology
- Compliance with ISO 22232-1
- A 100 % digital high dynamic range receiver design
- 30 digital receiver filters
- Maximum 2000 Hz pulse repetition frequency (PRF)
- Dynamic DAC/TCG sizing software
- Onboard DGS/AVG sizing software
- Optional analog output
- Digital alarm outputs
- USB and RS-232 connectivity
- Adjustment knob or navigational arrow keys
- 2 GB microSD memory card
- VGA Output Capability

Please thoroughly review this document with your EPOCH 650 in hand so that you can become familiar with the actual use of the instrument.

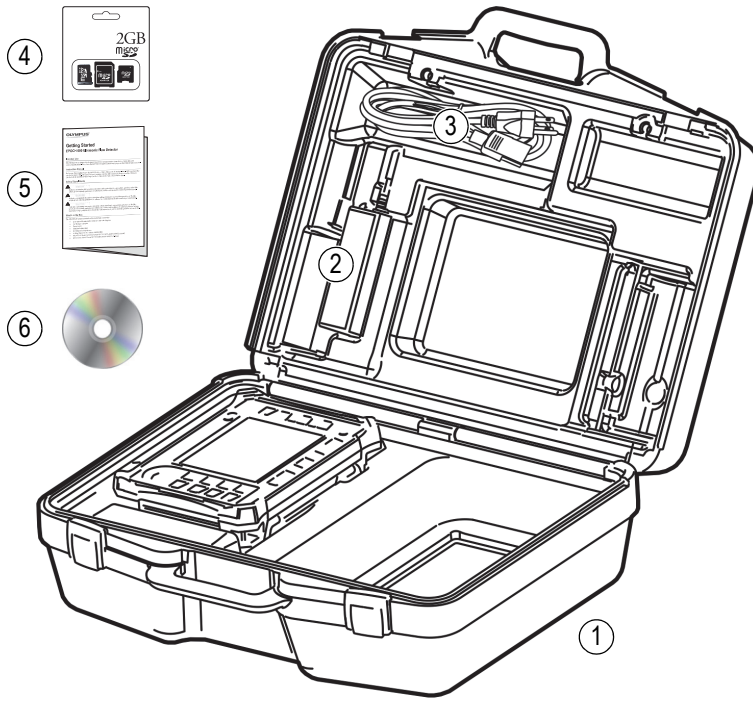
Evident recommends that all operators have a thorough understanding of the principles and limitations of ultrasonic nondestructive testing. Evident assumes no responsibility for incorrect operational procedure or interpretation of test results. We recommend that all operators seek adequate training prior to using this equipment.

While the EPOCH 650 is a continuously self-calibrating instrument, you must determine regulatory requirements. Evident offers calibration and documentation services. Contact Evident or your local representative with any special requests.

## Package Content

The EPOCH 650 comes standard with several key accessories (see Figure i-1 on page 29):

1. Instrument transport case (P/N: 600-TC [U8780294])
2. AC charger/adaptor (P/N: EP-MCA-X). Varies by configuration; must select power cord.
3. Power cord
4. 2 GB microSD removable memory card and adaptors (P/N: MICROSD-ADP-2GB [U8779307])
5. *Getting Started Guide* (P/N: DMTA-10056-01EN [Q7780001])
6. EPOCH 650 *Ultrasonic Flaw Detector User's Manual* on CD-ROM (P/N: EP650-MANUAL-CD [Q7780010])
7. USB cable (P/N: EPLTC-C-USB-A-6 [U8840031]). (USB cable not shown.)



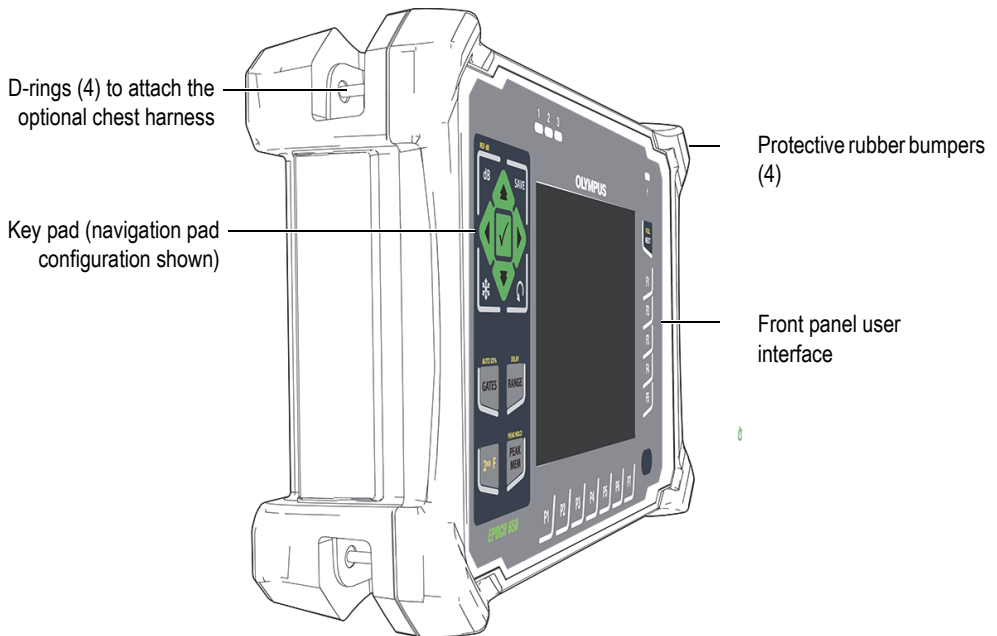
**Figure i-1 Transport case contents**

For a list of optional accessories, see the parts list on page 343.

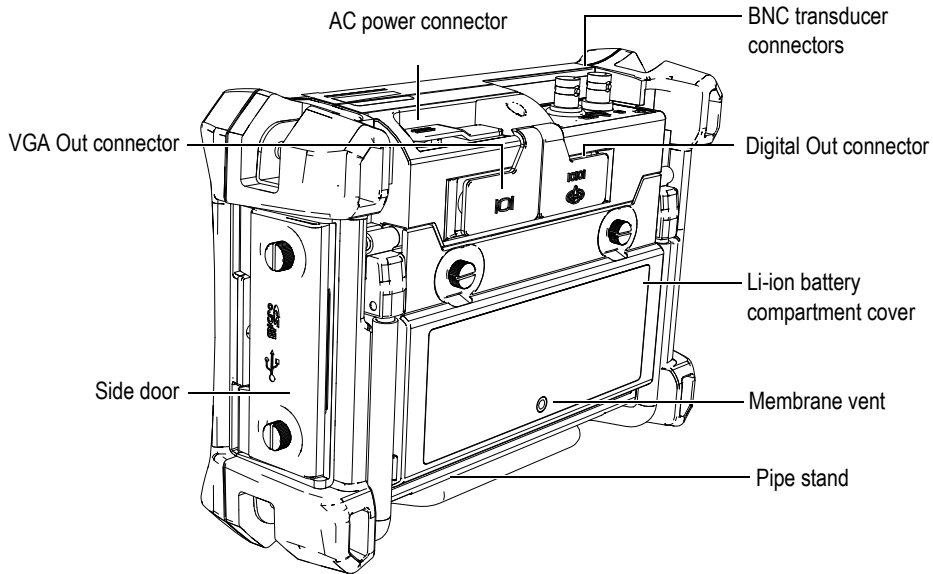


# 1. Hardware Overview

Figure 1-1 on page 31 and Figure 1-2 on page 32 show the EPOCH 650 ultrasonic flaw detector and identify its main components.



**Figure 1-1 EPOCH 650 front view**



**Figure 1-2 EPOCH 650 rear view**

## 1.1 Front Panel

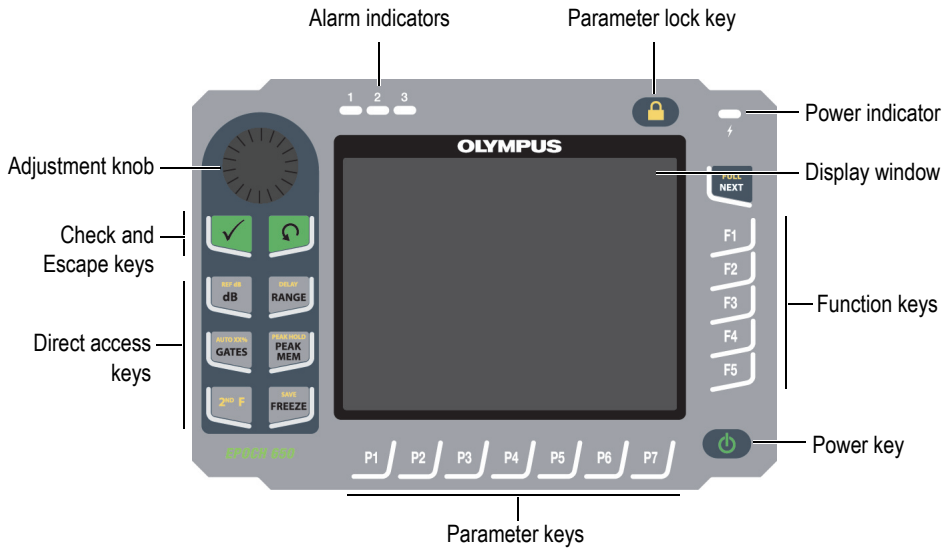
The EPOCH 650 front panel features a combination of direct-access keys, navigation arrows, dynamic function, and parameter access keys to optimize the usability of the instrument in any mode. The layout of the front panel provides direct access to common inspection parameters, and easy adjustment of values from either side of the instrument without obstructing the view of the display.

The EPOCH 650 is available in two front panel configurations to accommodate different user needs and preferences:

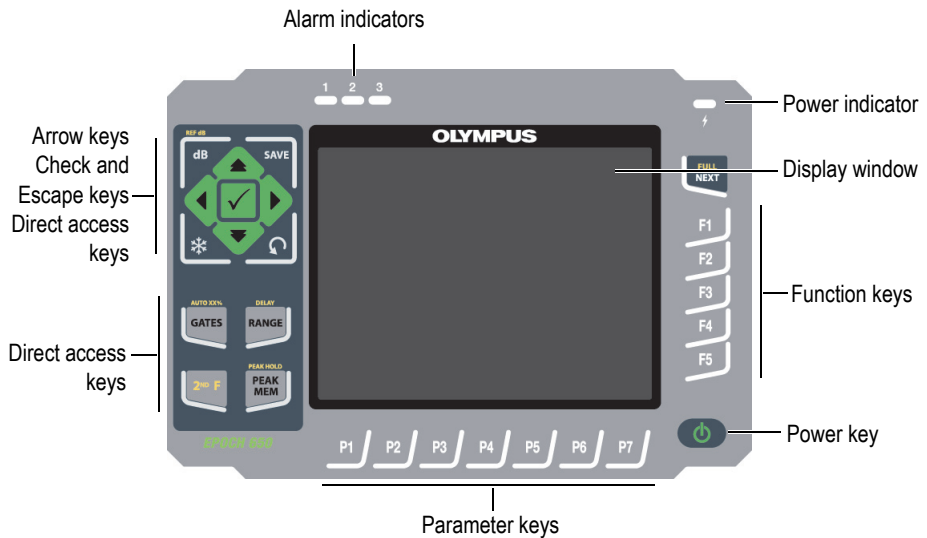
- Adjustment knob (see Figure 1-3 on page 33)
- Navigation pad (see Figure 1-4 on page 33).

Both configurations accomplish the same tasks using different physical layouts.






**Figure 1-3 The EPOCH 650 – Adjustment knob configuration**




**Figure 1-4 The EPOCH 650 – Navigation pad configuration**

## 1.1.1 Adjustment Knob Configuration

The adjustment knob configuration provides smooth value slewing (see Figure 1-6 on page 35). The adjustment knob is used along with the check key to adjust parameter values in either coarse or fine increments.


The adjustment knob () increases or decreases the value of a highlighted adjustable parameter.




The Check key () toggles a highlighted adjustable parameter between coarse and fine (see Figure 1-5 on page 34):

- Coarse adjustment is active when the highlighted parameter is surrounded by brackets.
- Fine adjustment is active when there are no brackets.

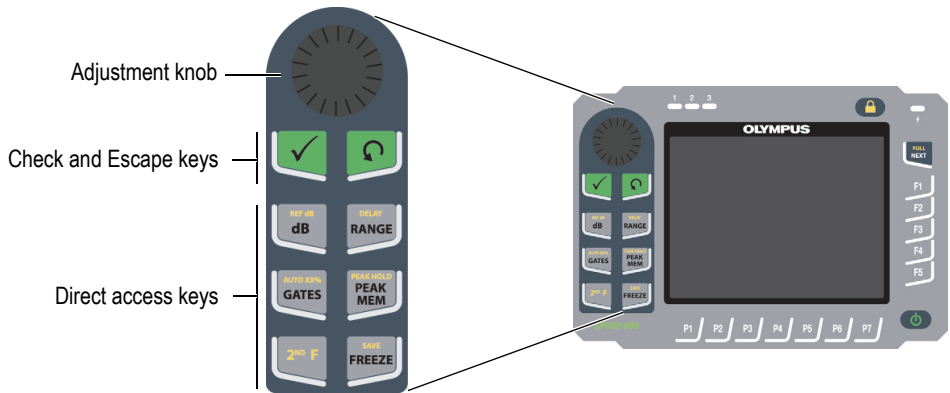


**Figure 1-5 Coarse (left) and fine (right) adjustment selection**

The Escape key () has three primary functions:

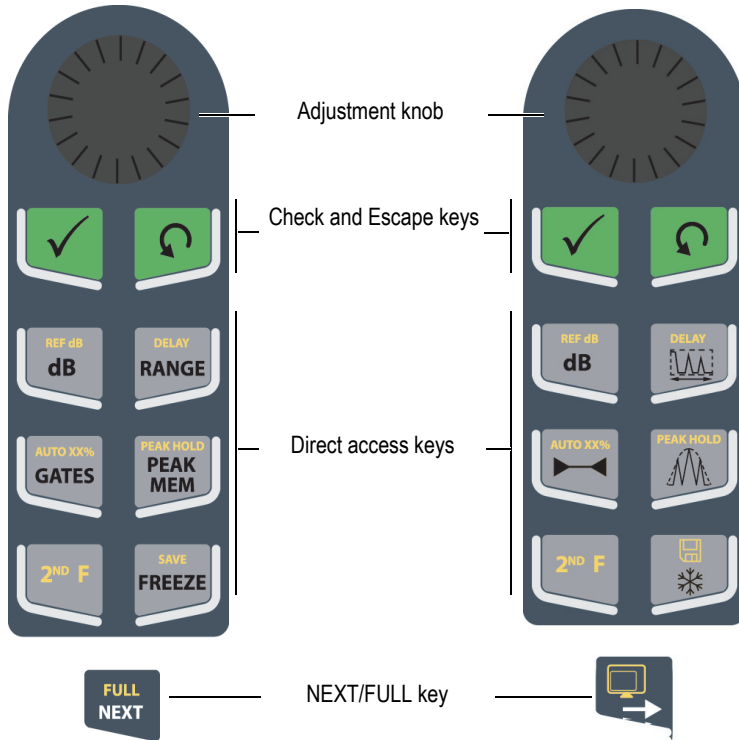
- When in a setup page,  returns to the live inspection screen.
- When in a selected menu,  returns to the basic menu.
- When a direct access parameter (gain, range, gates, etc.) is selected,  returns to the previous menu.

The direct access keys cause the software interface to jump directly to the associated parameter or activate a function (see “Direct-Access Keys” on page 40).



**Figure 1-6 The EPOCH 650 – Adjustment knob configuration**

In addition to the English, the EPOCH 650 is also offered with an international-symbol version of the adjustment knob configuration (see Figure 1-7 on page 36).



**Figure 1-7 Knob configuration (English and international versions)**

The EPOCH 650 is also offered in Chinese and Japanese versions of the adjustment knob configuration (see Figure 1-8 on page 37).

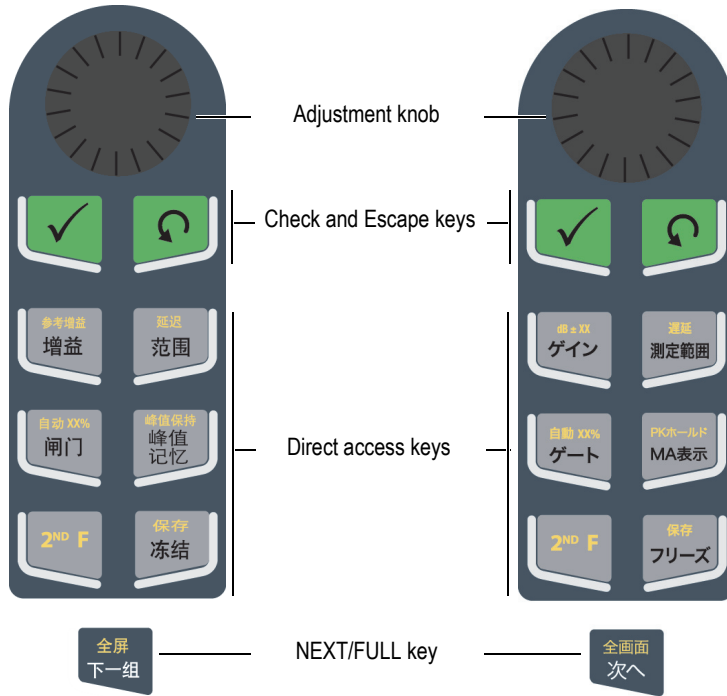




Figure 1-8 Knob configuration (Chinese and Japanese versions)

### 1.1.2 Navigation Pad Configuration

The navigation pad configuration is similar to previous EPOCH instruments to provide easy transitions within the EPOCH product line (see Figure 1-9 on page 38).

The Up and Down arrow keys (  ) make coarse adjustments to the value of a

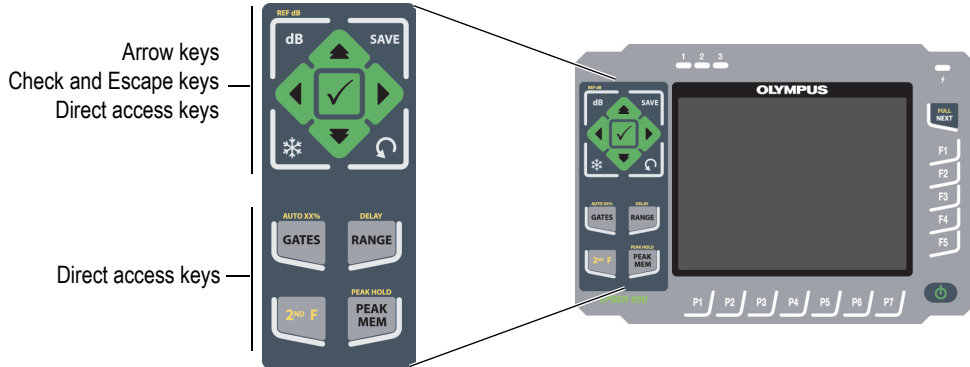
highlighted adjustable parameter. The Left and Right arrow keys (  ) make fine adjustments.

The Check key (✓) is used to scroll through the menus in numerical order (same as the NEXT key).

The Escape key (↶) has three primary functions:

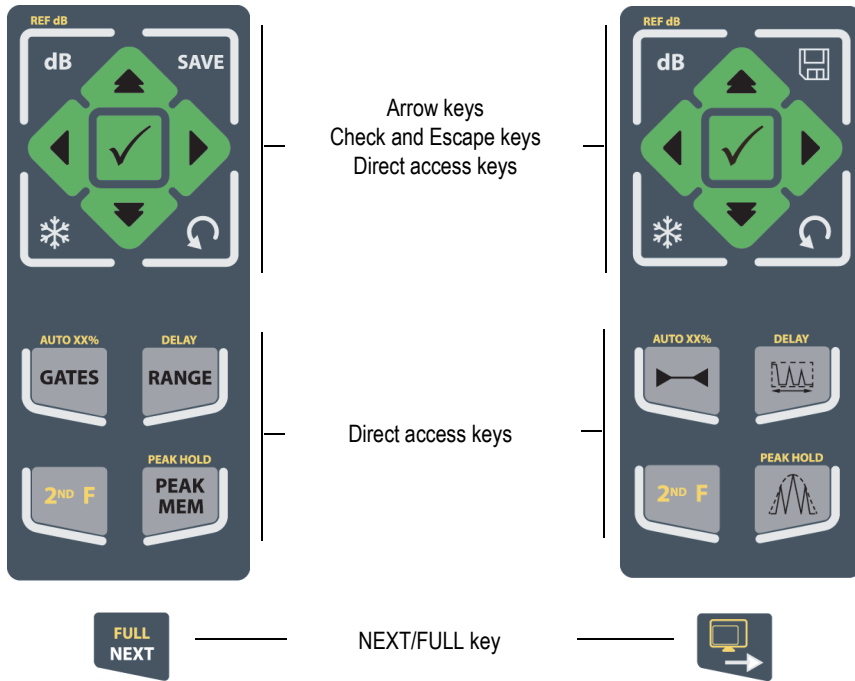
- When in a setup page, ↶ returns to the live inspection screen.
- When in a selected menu, ↶ returns to the **Basic** menu item.
- When a direct access parameter (gain, range, gates, etc.) is selected, ↶ returns to the previous menu.

The direct access keys cause the software interface to jump directly to the associated parameter or activate a function (see “Direct-Access Keys” on page 40).



**Figure 1-9 The EPOCH 650 – Navigation pad configuration**

The EPOCH 650 is also offered with an international-symbol version of the navigation pad configuration (see Figure 1-10 on page 39).



**Figure 1-10 Pad configuration (English and international versions)**

The EPOCH 650 is also offered with Chinese and Japanese versions of the navigation pad configuration (see Figure 1-11 on page 40).

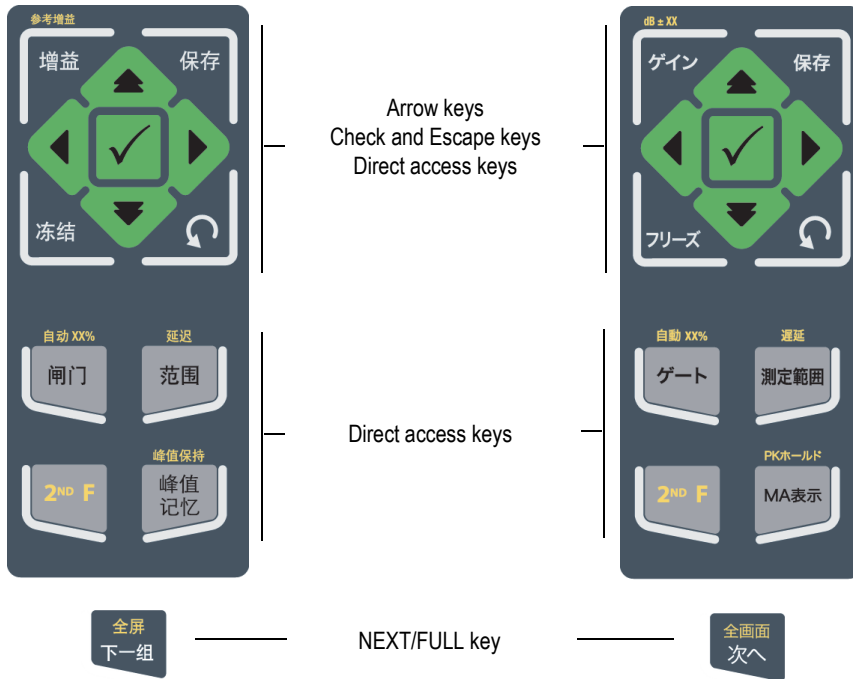














Figure 1-11 Pad configuration (Chinese and Japanese versions)

### 1.1.3 Direct-Access Keys



Table 1 on page 41 presents a description of each of the key for the English version of the keypad.



Table 1 English direct-access key descriptions

Navpad config.	Knob config.	Function
		dB Adjusts system sensitivity.
		2 <sup>ND</sup> F, (REF dB) Locks the reference gain level and allows the scanning gain to be used.
		SAVE Saves to the selected File and ID (navigation pad configuration only).
		2 <sup>ND</sup> F, (SAVE) Saves to the selected File and ID (knob configuration only).
		FREEZE Freezes holds the displayed waveform until FREEZE is pressed again.
		GATES Selects gates (1, 2, or IF) on the screen.
		2 <sup>ND</sup> F, (AUTO XX%) Automatically adjusts gated signal to XX% of full-screen height (see “Using the AUTO XX% Feature” on page 117).
		RANGE Adjusts the instrument’s range according to the sound level setting.
		2 <sup>ND</sup> F, (DELAY) Displays the delay that does not affect the calibrated zero offset.
		PEAK MEM Activates the peak memory function (see “Peak Memory” on page 128).
		2 <sup>ND</sup> F, (PEAK HOLD) Activates the peak hold function (see “Peak Hold” on page 130).

**Table 1 English direct-access key descriptions (continued)**

Navpad config.	Knob config.	Function
		<p>2<sup>ND</sup> F</p> <p>Accesses the second function identified above the keypad keys when pressed and released.</p>

## 1.1.4 Function and Parameter Keys

The function and parameter keys are identical in both appearance and function on both configurations of the EPOCH 650. Five function keys (F1 through F5) and seven parameter keys (P1 through P7) are located around the display (see Figure 1-12 on page 43). On the display, menu system software buttons appear vertically on the right side and horizontally at the bottom (see Figure 1-13 on page 44). The function and parameter keys allow you to individually activate a menu system software button.

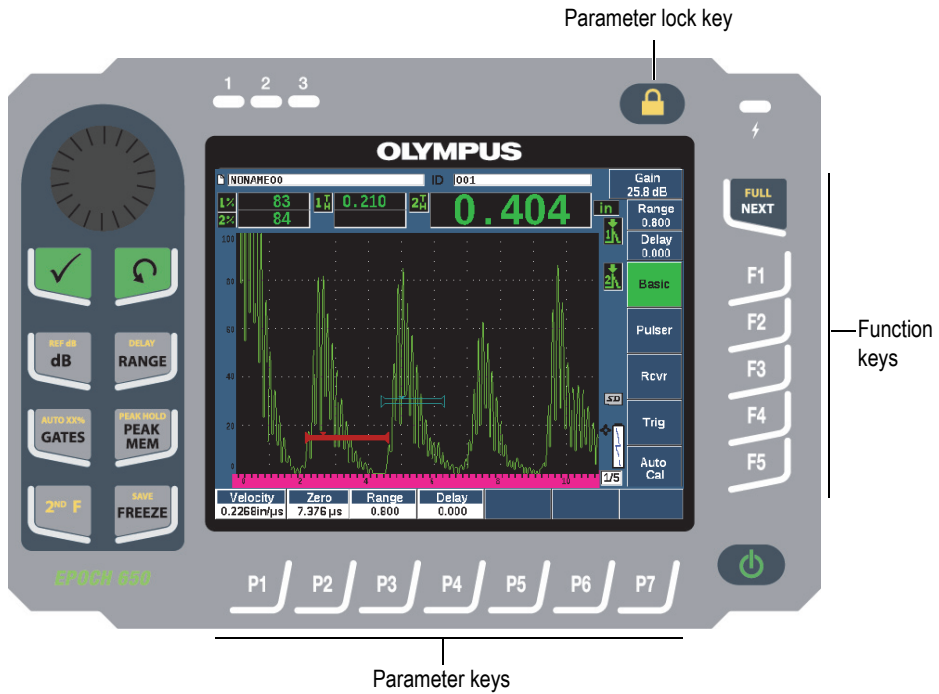


Figure 1-12 Function and parameter keys

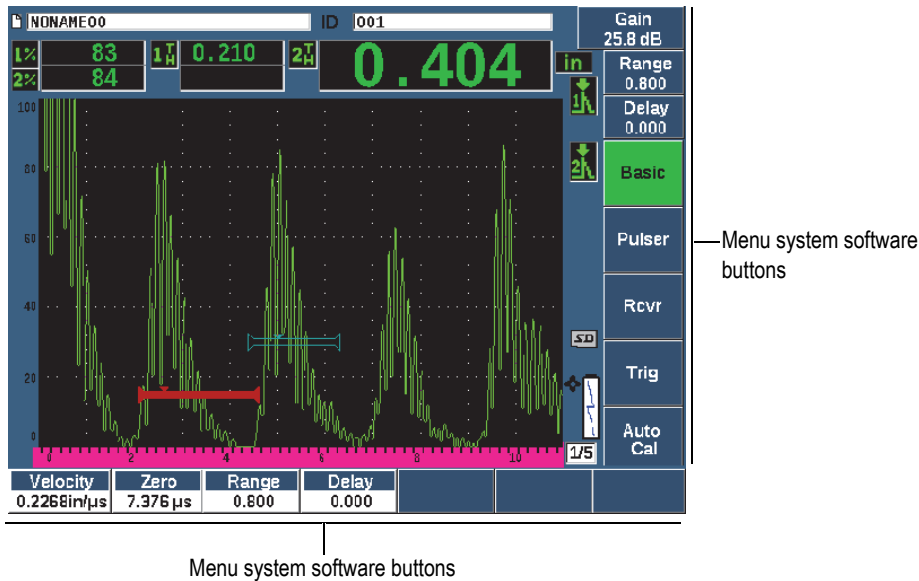


Figure 1-13 Menu system software buttons

### 1.1.5 Power Indicator

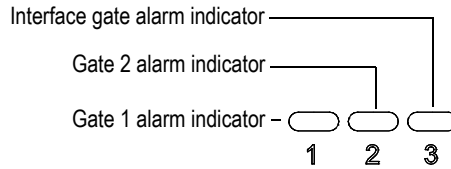
See Table 2 on page 59 for details on the meaning of the various states of the power indicator.



Figure 1-14 AC charger/adaptor power indicator

### 1.1.6 Alarm Indicators

The EPOCH 650 ultrasonic flaw detector provides three alarm indicator lights (see Figure 1-15 on page 45). The indicators are located on the front panel above the display window (see Figure 1-3 on page 33 and Figure 1-4 on page 33).



**Figure 1-15 Alarm indicators**

The alarm indicators illuminate in red when the corresponding gate alarm is triggered. See “Gate Alarms” on page 133 for information on gate alarms.

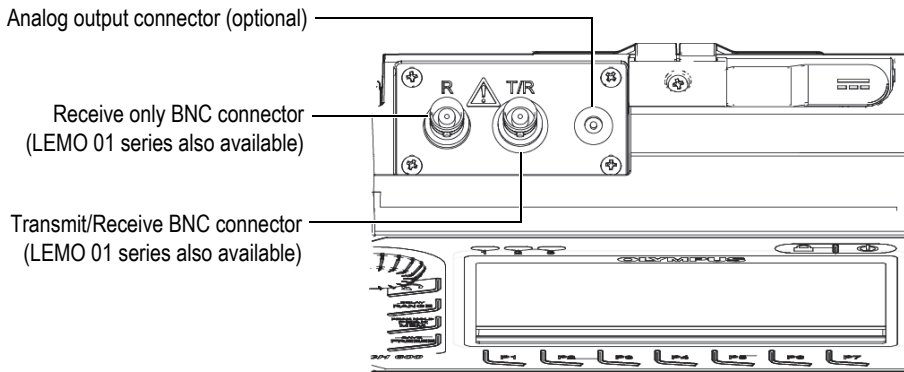
## 1.2 Connectors

The EPOCH 650 is equipped with connectors to allow the necessary and optional connections.

### 1.2.1 Transducer Connectors

The EPOCH 650 instrument is supplied with either BNC or LEMO 01 series transducer connectors. The type of transducer connector is chosen at the time of order. If necessary, it is possible to change the type of transducer connection at an authorized Evident service center for a small charge. Selection of these transducer connections is based on operator preference. Both the BNC and LEMO 01 series connectors available are rated to IP67 for use in most inspection environments. The EPOCH 650 is illustrated with BNC connectors in this document.

The transducer connectors are located at the top of the instrument on the left. The two connectors are easily accessible from the front of the instrument (see Figure 1-16 on page 46).



**Figure 1-16 Location of the transducer connectors**

For single-element transducers, either transducer connector may be used. For some dual transducer and for through-transmission inspections, the transducer connectors are labeled T/R and R. The T/R connector should be used as the transmit channel, and R should be used as the receive channel in these situations.

An optional analog output connector is located at the top of the instrument, to the right of the transducer connectors.

See “Input/Output Specifications” on page 317 for the complete specifications of the supported I/O signals.

## 1.2.2 Digital Out Connector

The EPOCH 650 ultrasonic flaw detector comes standard with a Digital Out connector. This connector provides alarm outputs, serial communication, trigger synchronization, and encoder inputs. See “Input/Output Specifications” on page 317 for the complete specifications of the supported I/O signals.

The Digital Out connector is located at the back of the EPOCH 650 (see Figure 1-17 on page 49). A rubber cover protects the connector.

**CAUTION**

Ensure the rubber protective cover over the Digital Out connector is firmly closed before exposing the EPOCH 650 to harsh and wet environments. Always keep the rubber protective cover firmly closed when no cable is connected.

---

### 1.2.2.1 Alarm Output Connector Pins

The EPOCH 650 includes three dedicated alarm outputs that allow you to control an external device based on an alarm condition. These outputs are combined with the Digital Out signals on the same connector (see Table 21 on page 317). Each alarm output is a 5V TTL digital signal that corresponds to the current alarm condition for each gate. See “Gate Alarms” on page 145 for details on the gate alarm functions. When a gate alarm is triggered, the corresponding alarm output switches from 0V to 5V TTL.

In addition to three dedicated digital alarm outputs, the EPOCH 650 also includes a pulse width modulated (PWM) output. This output is enabled by any alarm condition on the instrument, and is intended to provide an output to control an external horn or beeper. The N600-EXTALM (U8780332) external alarm box (optional item) is controlled by this output and amplifies the alarm beep compared to the internal beeper included with the EPOCH 650.

### 1.2.2.2 Serial Communication Pins

Serial communication allows remote command of the EPOCH 650. A comprehensive series of remote commands is available to allow you access to all functions of your instrument. Contact Evident for further information.

### 1.2.2.3 Encoder Input Pins

The EPOCH 650 supports single axis quadrature encoder inputs through the Digital Out connector. The encoder input pins are exclusively supported by the B-scan feature embedded in the Corrosion Module software option (see “Corrosion Module” on page 287). The optional Evident B-scan encoder BSCAN-ENC (U8779522) can be connected to the EPOCH 650 using the CBAS-10669-0010 (Q7790008) encoder cable. Other encoders can be supported using customized cables (see Table 21 on page 317 for the specifications of the supported I/O signals).

### 1.2.2.4 Trigger Input and Output Pins

The EPOCH 650 trigger synchronization capability allows the instrument to be used with other devices or instruments. The trigger governs the timing of each instrument pulse based on the chosen method and, where applicable, external input. Trigger synchronization is supported as either a trigger input or trigger output on a combined signal through the Digital Out connector (see Table 21 on page 317).

### 1.2.3 VGA Out Connector

The VGA Out connector is located at the back of the EPOCH 650 ultrasonic flaw detector (see Figure 1-17 on page 49). A rubber cover protects the connector.

Using the VGA output, you can display the full contents of the EPOCH 650 screen on any device that accepts VGA input.

#### To connect the VGA output to a VGA device

1. Connect one end of the 600-C-VGA-5 (U8780298) cable (optional item) to the EPOCH 650 VGA out connector.
2. Connect the other end of the cable to the VGA device.

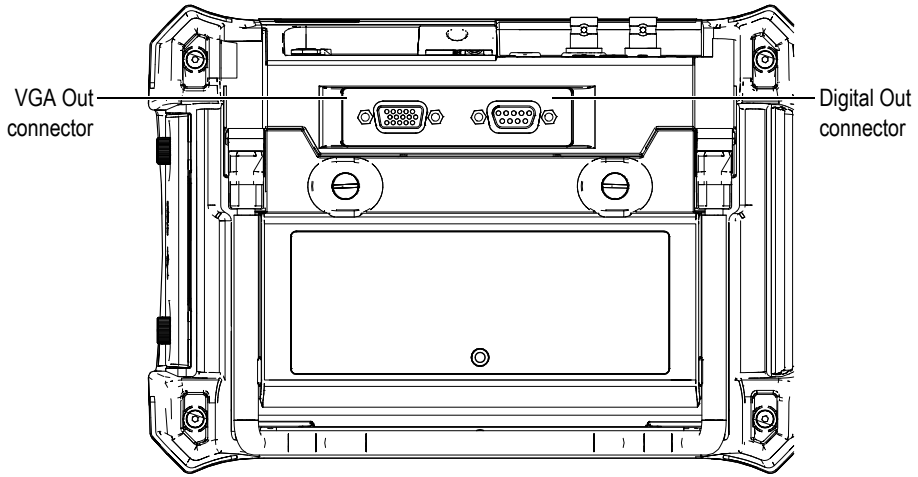


#### **CAUTION**

Ensure the rubber protective cover over the VGA Out connector is firmly closed before exposing the EPOCH 650 to harsh and wet environments. Always keep the rubber protective cover firmly closed when no VGA cable is connected.

---

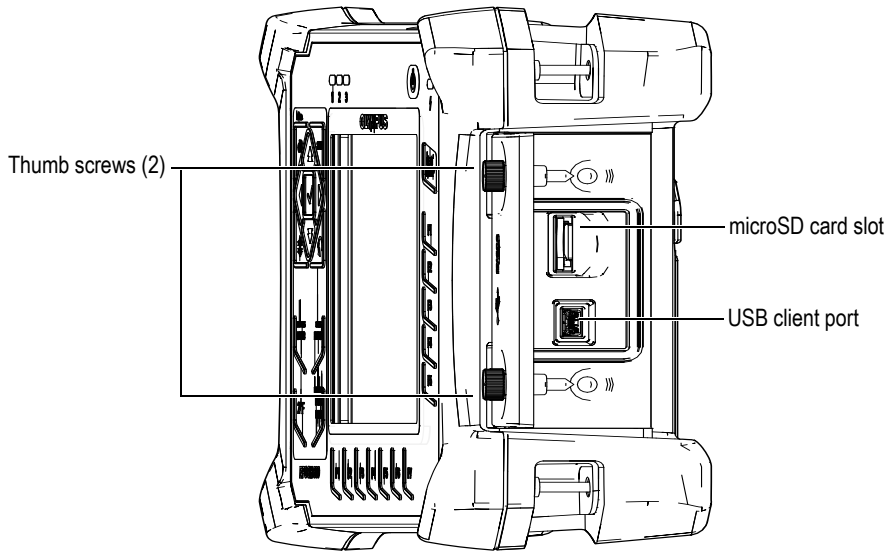




**Figure 1-17 The RS-232/Alarms and VGA Out connectors**

## 1.2.4 USB Client Port and microSD Card Slot

The microSD card slot and USB port are located on the right side of the EPOCH 650 ultrasonic flaw detector. A protective cover has an integral membrane seal to keep out liquids (see Figure 1-18 on page 50). Two thumb screws on the protective cover allow quick access to the microSD slot and USB port without the need for tools.



**Figure 1-18 The connectors behind the protective cover**

### 1.2.4.1 USB Client Port

The EPOCH 650 ultrasonic flaw detector comes standard with one USB port currently used for PC client communication. The USB client port allows one-way communication only. A peripheral device can pass commands to the EPOCH 650, but the EPOCH 650 cannot pass commands to a peripheral device.

To connect any device (including a personal computer) to the EPOCH 650, an appropriate USB cable is required.



#### **CAUTION**

Do not expose the instrument to harsh and wet environments while the computer connection protective cover is opened. To prevent connector corrosion and damage to the instrument, keep the computer connection protective cover closed and sealed when no cable is connected.

---

## 1.2.4.2 microSD Card Slot

A 2 GB microSD card is included with every EPOCH 650, but most types and capacities of microSD cards can be used.

### To install the microSD memory card

1. Remove the card from its packaging.
2. Loosen the two thumb screws, and then open the computer connection protective cover (see Figure 1-19 on page 51).
3. Hold the microSD card so that the metal pins face toward the front of the instrument.
4. Carefully slide the card into the microSD slot until it clicks.

### To remove the microSD card

- ◆ Carefully push the card into the instrument and release. A spring mechanism partially ejects the card so you can grasp and remove it from the instrument.

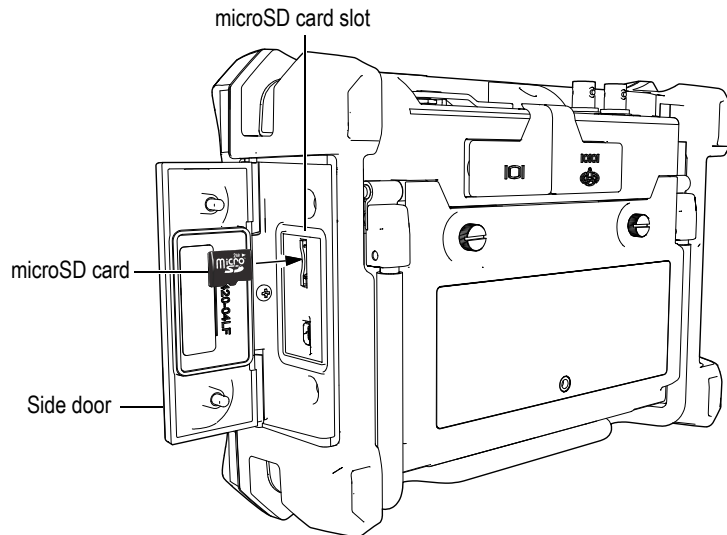


Figure 1-19 Installing the microSD card

## 1.3 Battery Compartment

Two thumb screws on the battery compartment cover allow quick access to the lithium-ion battery pack without the need for tools (see Figure 1-20 on page 52).

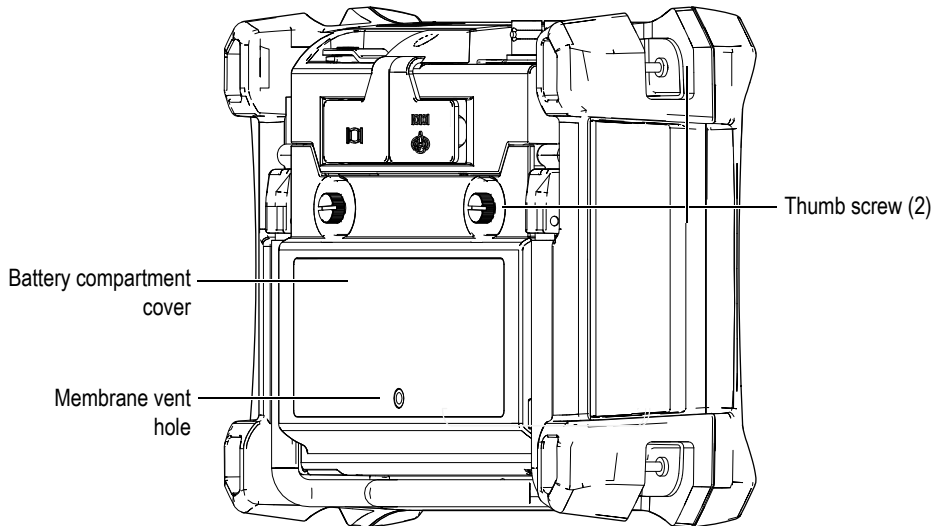
The battery compartment cover also has a small hole in the bottom center area that is covered on the inside by an environmentally sealed membrane vent.

---

**IMPORTANT**

The membrane vent is a safety feature that is required in the event that the instrument battery fails and emits gas. This vent must not be punctured.

---

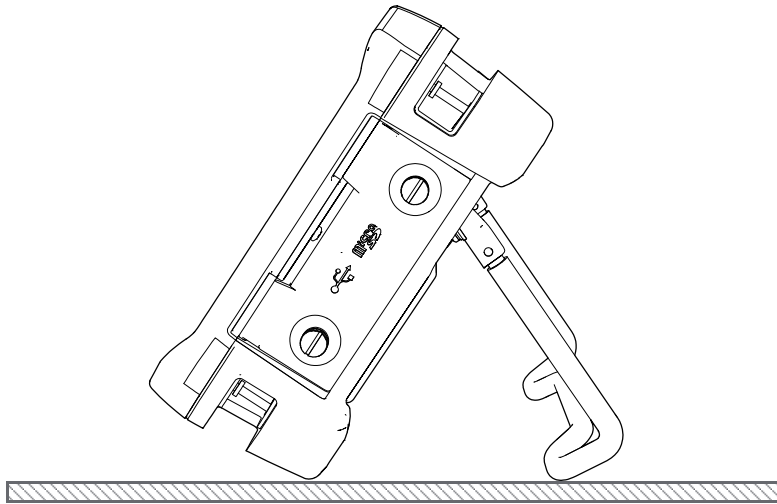


**Figure 1-20 The battery compartment**

The EPOCH 650 ultrasonic flaw detector accepts one rechargeable lithium-ion battery pack (P/N: 600-BAT-L-2 [U8760058]) that can be recharged inside the instrument or on the optional external charging base (P/N: EPXT-EC-X).

## 1.4 Instrument Stand

The EPOCH 650 ultrasonic flaw detector features an articulating pipe stand for variable viewing angles (see Figure 1-21 on page 53). The stand is attached to the back of the instrument with two hard pivot blocks, and has a high friction coating for resistance to sliding during use. The stand is shaped to easily accommodate placement on a curved surface.



**Figure 1-21 Instrument resting on stand**



---

## 2. Powering the EPOCH 650

---

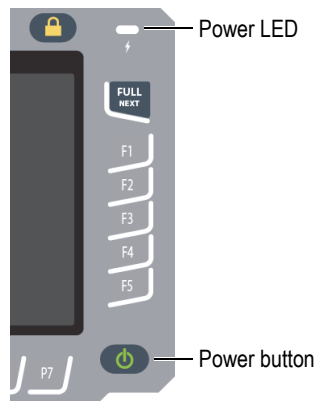
The EPOCH 650 ultrasonic flaw detector is designed to operate using either of two power supply sources:

- Internal lithium-ion battery
- Directly from the EPOCH charger/adaptor

Whatever source is selected, the power on/off procedure is the same.

### To power on or off the EPOCH 650

1. Press the Power button to turn on the EPOCH 650 (see Figure 2-1 on page 55).  
Pressing this key once causes an initial beep, followed by the instrument startup screen. Approximately 5 seconds later, a second beep indicates that the system is ready for use.



**Figure 2-1 Location of the EPOCH 650 power key and indicator**

2. Press the Power button to turn off the EPOCH 650.  
The system beeps, then immediately shuts down.

## 2.1 Lithium-Ion Battery

The lithium-ion (Li-ion) battery is the primary method for powering the EPOCH 650. This battery comes installed in every instrument. When properly maintained, and when the instrument is operated under typical inspection conditions, the lithium-ion battery should provide between 15 and 16 hours of continuous operation. For instructions on replacing the battery, see “Replacing the Battery” on page 309.

---

<b>TIP</b>
------------

Make a habit of ensuring the battery is fully charged *before* taking the instrument out into the field (see Table 2 on page 59 for information on reading the charging status).

---

<b>NOTE</b>
-------------

The battery may require several complete charge/discharge cycles to reach full capacity. This conditioning process is normal for these types of rechargeable batteries.

---

### Maximizing Battery Performance

By nature, unused batteries slowly discharge. A fully discharged battery does not recharge. Follow the instructions below to maximize the battery performance:

- When the battery is used daily, connect it to the AC charger/adaptor when not in use.
- Whenever possible, the battery should remain connected to the AC charger/adaptor (overnight or over a weekend), so that it achieves 100 % full charge.
- The battery must reach full charge on a regular basis for proper capacity and cycle-life maintenance.
- Recharge discharged batteries as soon as possible after use.



- Store batteries in a cool, dry environment.
- Avoid long-term storage under sunlight or in other excessively hot places such as an automobile trunk.
- While in storage, fully recharge batteries at least once every two months.
- Never place partially discharged batteries in storage without a full recharge.

## 2.2 AC Charger/Adaptor

The EPOCH 650 AC charger/adaptor is provided with every instrument. The charger/adaptor allows you to power the EPOCH 650. When a lithium-ion rechargeable battery is installed in the instrument and the charger/adaptor is connected, the battery charges.



### WARNING

The EPOCH 650 charger/adaptor is designed to charge EPOCH 650 batteries only (P/N: 600-BAT-L-2 [U8760058]). Do not attempt to charge any other batteries or use any other chargers/adaptors. Doing so can cause an explosion or injury.

---

### To connect the AC charger/adaptor

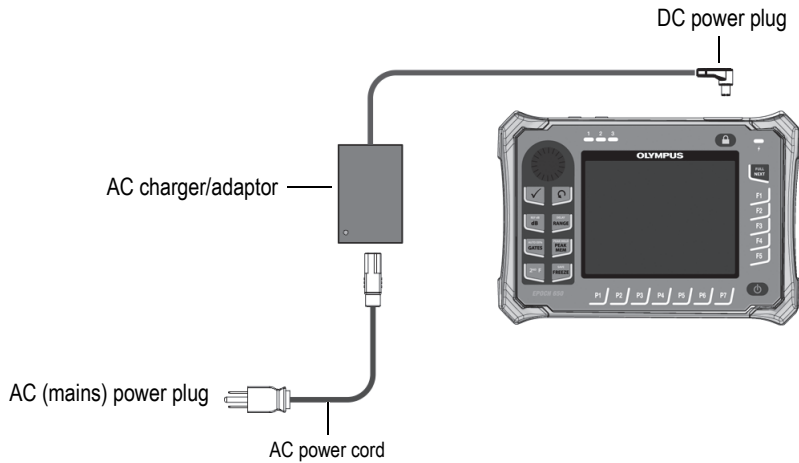
1. Connect the power cord to the charger/adaptor unit and to an appropriate power outlet (see Figure 2-2 on page 58).



### CAUTION

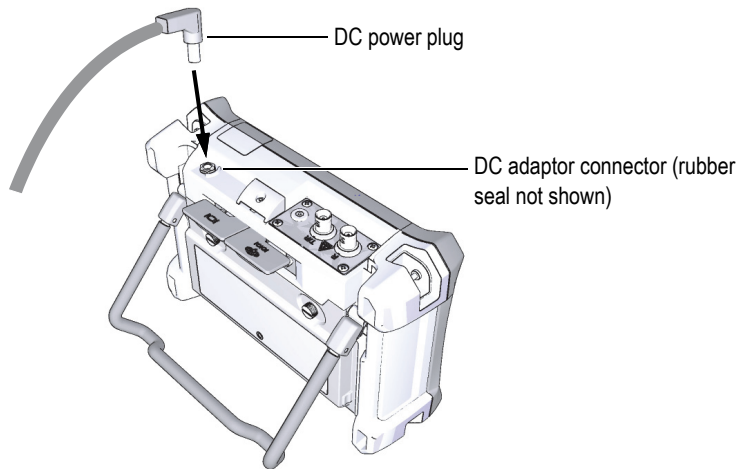
Use only the AC power cord supplied with the EPOCH 650. Do not use the supplied AC power cord with other products.

---



**Figure 2-2 Connecting the charger/adaptor**

2. Lift the rubber seal that covers the AC charger/adaptor connector on top of the EPOCH 650 instrument.
3. Connect the DC power plug to the DC adaptor connector (see Figure 2-3 on page 58).



**Figure 2-3 Connecting the DC power plug**

## 2.3 Standalone Battery Charger

The EPOCH 650 ultrasonic flaw detector battery can also be charged externally using the optional standalone battery charger (P/N: EPXT-EC-X). Charging a battery externally allows you to charge one battery while using another in the instrument. For more information about the external charger, contact Evident or your local sales representative.

## 2.4 Power Status Indicators



The power status of the AC charger/adaptor *and* the battery charge status are indicated by both the front panel AC charger/adaptor power indicator (see Figure 2-4 on page 59), and the user interface Battery/AC indicator (see Table 2 on page 59).




**Figure 2-4 Front panel AC charger/adaptor power indicator**

The status states of the Battery/AC indicator are shown in Table 2 on page 59. The Battery/AC indicator is accurate after 5 to 10 minutes of use.

**Table 2 EPOCH 650 power status indicators**

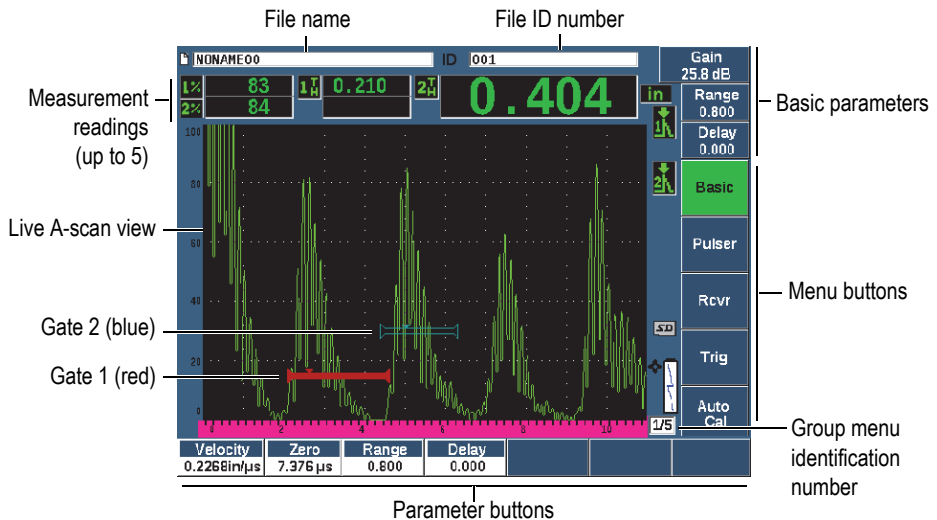
AC charger/adaptor power indicator	AC power connected?	Status	Battery/AC indicator
Green	Yes	Li-ion battery either fully charged, or not installed	
Red	Yes	Li-ion battery installed and charging	

**Table 2 EPOCH 650 power status indicators***(continued)*

<b>AC charger/adaptor power indicator</b>	<b>AC power connected?</b>	<b>Status</b>	<b>Battery/AC indicator</b>
Green	No	Li-ion battery level as indicated by the black horizontal bar	

### 3. Software Overview

The EPOCH 650 software main display is shown in Figure 3-1 on page 61.



**Figure 3-1 Software main display elements**

There are five groups of menus on the EPOCH 650. Each menu group is identified with a number (1/5, 2/5, 3/5, 4/5, and 5/5). The menu indicator, located in the lower-right corner of the software main display, shows which menu is currently selected (see Figure 3-1 on page 61). For example, the menu indicator showing 1/5, means that there are five standard available menus and that the first one is currently selected. To scroll through all menu groups, use the NEXT key (see Figure 3-2 on page 62).

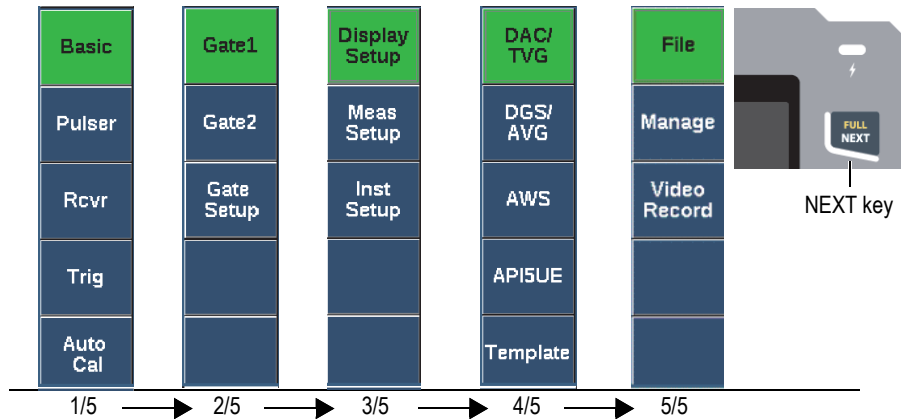


Figure 3-2 The menu groups and their level numbers

### 3.1 Choosing a Function Menu Item

The function menu item with a green background is the function that is selected. At startup, the first function menu item in each of the five menu groups is the default selection (see Figure 3-2 on page 62). Only one function menu item at a time can be selected.

#### To choose a function menu item

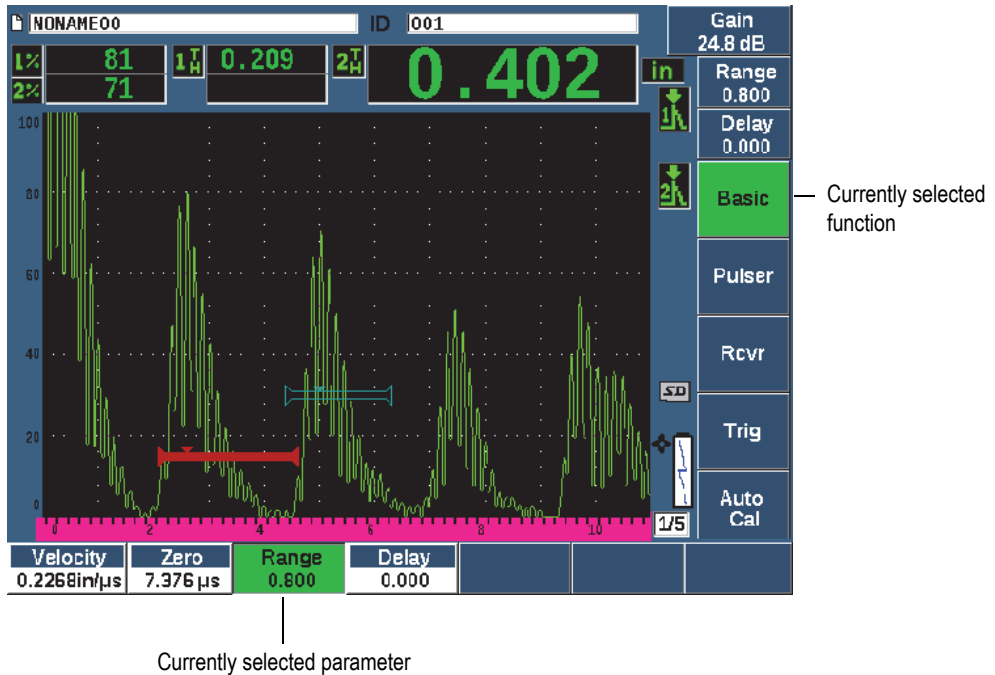
- ◆ Press the corresponding function key.  
For example, if you want to choose the **Basic** function in menu group one, press the F1 key (see Figure 3-3 on page 62).



Figure 3-3 F1 key selecting the Basic function

## 3.2 Parameter Selection

When a parameter button has a green background it is selected, and the corresponding function button remains green (see Figure 3-4 on page 63).



**Figure 3-4 The focus is on the selected parameter (green)**

### To select a parameter

- ◆ Press the corresponding parameter key.  
For example, if you want to choose the **Range** parameter, press the P3 key (see Figure 3-5 on page 64).



Figure 3-5 P3 key selecting the Range parameter

### 3.3 Convention for Identifying Menu Items and Parameters

The following convention is used to concisely refer to an element in the menu structure:

**Menu > Parameter = value**

where:

**Menu** represents the name of the menu item (example: **Meas Setup**)

**Parameter** represents the name of the parameter (example: **Unit**)

**Value** represents the desired editable or selectable parameter value (example: **mm**)

For example, to instruct you to set the **Unit** parameter to **mm**, in the **Meas Setup** menu, the expression: **Meas Setup > Unit = mm** is used.

Choose **Meas Setup > Unit = mm**




If the value cannot be edited, the expression does not include a value:

Choose **Gate1 > Zoom**

### 3.4 Parameter Adjustment


When a parameter such as gain or range is selected, you can modify it using the arrow keys or adjustment knob (depending on your hardware configuration).






- The Up and Down arrow keys () make coarse adjustments to the value of a highlighted adjustable parameter. The Left and Right arrow keys () make fine adjustments.
- The adjustment knob turns clockwise or counterclockwise to increase or decrease a parameter value. The Check key () toggles between coarse and fine adjustments.

For both the navigation pad and adjustment knob configurations, you can customize preset values for coarse adjustment (see “Editable Parameters Page” on page 114)

### 3.5 Escape Key

The Escape key () has three primary functions:

- When in a setup page,  returns to the live inspection screen.
- When in a selected menu,  returns to the **Basic** menu item.
- When a direct access parameter (gain, range, gates, etc.) is selected,  returns to the previous menu.

### 3.6 Lock Key

The Lock key (knob configuration only) automatically locks adjustment of all parameters to prevent any unwanted parameter modifications because of accidental knob movement (see Figure 3-6 on page 66).

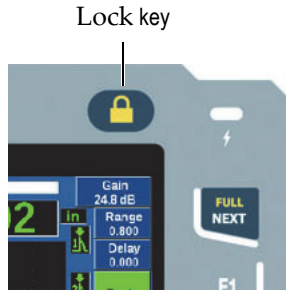


Figure 3-6 Adjustment knob configuration – Lock key

### 3.7 AUTO XX% Feature

Pressing 2<sup>ND</sup> F, (AUTO XX%) activates the AUTO XX% feature, which automatically adjusts the gain in order to set the gated echo amplitude to XX% of full screen height (the default XX value is 80 %). (See Figure 3-7 on page 66.)

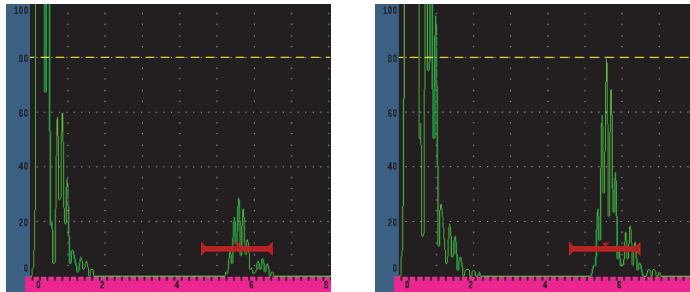


Figure 3-7 The AUTO XX% feature: inactive (left) and active (right)

### 3.8 Submenus

When selecting certain items, such as **Display Setup**, the NEXT key scrolls through rows within the submenu, the adjustment knob or navigation pad arrows adjust the chosen value, and the Escape key (↶) returns to the live A-scan view.

## 3.9 Pulser and Receiver Settings

The EPOCH 650 allows access to most of its pulser and receiver settings through the **Pulser** and the **Rcvr** menus. System sensitivity (gain) and reference gain are controlled exclusively using the direct-access keys.

### 3.9.1 Sensitivity

The system sensitivity (gain) is adjusted using the dB direct-access key.

#### To adjust the system sensitivity

1. Press dB.
2. Adjust the value:

Use the navigation pad arrow keys or rotate the adjustment knob in either coarse or fine increments

OR

Press one of the parameter keys to choose the corresponding preset value

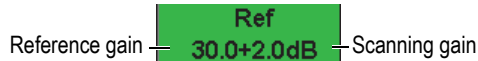
You can automatically adjust gain using the AUTO XX% feature. See “Escape Key” on page 65.

### 3.9.2 Reference Gain

You can define a reference gain by pressing 2<sup>ND</sup> F, (REF dB). This sets the current gain as the reference gain and activates a scanning gain for further adjustments (see Figure 3-8 on page 68).

When the reference gain is set, the parameter keys allow access to the following functions:

- **Add:** Combines current scanning gain with current reference gain and sets the resultant as the new reference gain.
- **Scan dB:** Toggles between current scanning gain and 0.0 dB scanning gain.
- **Off:** Turns off reference gain feature (scanning gain is lost).
- **+6 dB:** Increases the scanning gain by 6 dB.
- **-6 dB:** Decreases the scanning gain by 6 dB.



**Figure 3-8 The reference and scanning gains**

### 3.9.3 Pulser

The EPOCH 650 main pulser functions are accessible by choosing the **Pulser** menu. Each individual pulser parameter is displayed above the parameter keys, and can be adjusted by pressing the corresponding parameter key.

The following pulser functions are available for live adjustment in the **Pulser** menu:

- **PRF Mode:** Selects either Auto or Manual PRF (Pulse Repetition Frequency) adjustment mode. **Auto** changes the PRF setting based on the screen range, and **Manual** allows manual adjustment of PRF in 10 Hz increments.
- **PRF:** Pulse Repetition Frequency values range: from 10 Hz to 2000 Hz in 10 Hz increments
- **Energy:** Pulse voltage values available: 0 V, 100 V, 200 V, 300 V, or 400 V
- **Damp:** Pulse damping values available: 50  $\Omega$ , 100  $\Omega$ , 200  $\Omega$ , or 400  $\Omega$
- **Mode:** pulse modes available: **P/E** (pulse-echo), **Dual**, and **Thru** (through-transmission)
- **Pulser:** Pulser waveforms available: **Spike** or **Square** (tunable square wave)
- **Freq:** Pulse frequency (square wave pulse width) ranges from 0.1 MHz to 20.00 MHz

---

<b>NOTE</b>
-------------

The Spike pulse is equivalent to a 20 MHz square wave pulse.

---

### 3.9.4 Receiver

The EPOCH 650 standard receiver functions are accessible by choosing the **Rcvr** menu. Each individual receiver parameter is displayed above the parameter keys, and can be adjusted by pressing the corresponding parameter key.

The following receiver parameters are available for live adjustments in the **Rcvr** menu:

- **Filter:** Receiver filter setting
- **Rect:** Waveform rectification (**Full** full wave, **Half+** half wave positive, **Half-** half wave negative, **RF** no rectification)
- **Reject:** Percent reject (from 0 % to 80 %)

The 30 filters available on the EPOCH 650 allow broadband or narrowband settings to match the requirements of a given application. Each filter is a fully digital filter set. Table 3 on page 69 lists the low-pass and high-pass cutoffs for each available filter.

**Table 3 Filter cutoffs**

0.2 MHz–10 MHz	2.0 MHz–21.5 MHz
8.0 MHz–26.5 MHz	0.5 MHz–4.0 MHz
0.2 MHz–1.2 MHz	1.5 MHz–8.5 MHz
5.0 MHz–15 MHz	DC–10 MHz
DC–1.2 MHz	DC–4.0 MHz
DC–8.5 MHz	DC–15.0 MHz
DC–26.5 MHz	0.2 MHz–4.0 MHz
0.2 MHz–8.5 MHz	0.2 MHz–15.0 MHz
0.2 MHz–26.5 MHz	0.5 MHz–10.0 MHz
0.5 MHz–8.5 MHz	0.5 MHz–26.5 MHz
0.5 MHz–15.0 MHz	1.0 MHz–3.5 MHz
1.5 MHz–10.0 MHz	1.5 MHz–15.0 MHz
1.5 MHz–26.5 MHz	2.5 MHz–7.0 MHz
5.0 MHz–10.0 MHz	5.0 MHz–26.5 MHz
6.0 MHz–12.0 MHz	8.0 MHz–15.0 MHz

## 3.10 Gates

The EPOCH 650 features two standard independent measurement gates and one optional independent measurement gate. Gate 1 and gate 2 are the standard measurement gates. The Interface Gate is an optional measurement gate principally used in immersion applications (see “Interface Gate” on page 283).

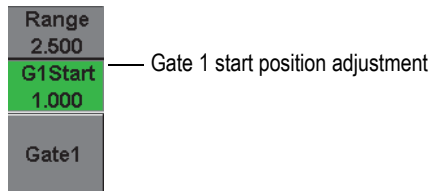
Gate 1 is displayed as a red, solid horizontal bar. Gate 2 is displayed as a blue, hollow horizontal bar. The Interface Gate is displayed as a yellow, hollow horizontal bar.

These gates independently define digital measurements regions for amplitude, time-of-flight measurements, and other specialized readings. Each gate also features alarm and zoom functions.


### 3.10.1 Quickly Adjusting Basic Gate Parameters

The GATES direct-access key allows instant access to gate start, width, and level adjustments without requiring the user to enter any gate-related menus. This is the most common method for gate adjustments.

When GATES is pressed, the box above the first menu displays the gate 1 start position (see Figure 3-9 on page 70). Once a gate is selected, the knob or arrows can increase or decrease this value, in coarse or fine increments.



**Figure 3-9 The Gate 1 start position adjustment**

Pressing GATES repeatedly scrolls through the start, width, and level setting of every active gate. Pressing  or NEXT returns focus to the menu group used before gate adjustment, allowing efficient adjustment of the gates with minimal interference for the operator.

For more comprehensive gate setup and adjustment, there are three menus that manage gate settings: **Gate1**, **Gate2**, and **Gate Setup**.

---

### 3.10.2 Gate 1 and Gate 2

Both **Gate 1** and **Gate 2** menus allow access to specific gate positioning and alarm functions. When either menu is selected, the following parameters become visible above the parameter keys.

- **Zoom:** Sets the display range to begin at the start position of the selected gate, and to stop at the end position of the selected gate (gate start + gate width).

---

<b>NOTE</b>
-------------

Pressing the **Zoom** parameter key repeatedly toggles the zoom on and off.

---

- **Start:** Adjusts the start position of the selected gate.
- **Width:** Adjusts the width of the selected gate.
- **Level:** Adjusts the screen height of the selected gate (from 3 % to 95 %).
- **Alarm:** Sets the alarm condition of the selected gate (**Off, Positive, Negative, Min Depth**)
- **Min Depth:** Visible only when the **Alarm** parameter is set to **Min Depth**. Adjusts the threshold in time-of-flight units that triggers a Min Depth alarm condition.
- **AFreeze:** Visible only when Alarm is Positive or Negative. Activates or deactivates the Auto Freeze function (for more information, see “Freeze” on page 130).
- **Status:** Turns the gate on or off (effects measurements, alarms, and visibility of gate on screen).

### 3.10.3 Gate Setup

The Gate Setup menu allows more advanced settings for each gate to be adjusted prior to inspection. These settings are visible above the parameter keys. The following gate settings are available in the Gate Setup menu:

- **G1 Mode:** Sets the measurement trigger mode of gate 1 (Peak, 1stPeak, Edge, J-Flank)
- **G1 RF:** Sets the polarity of the gate 1 when the instrument is operating in RF rectification (Dual, Positive, Negative)
- **G1 %Amp:** Used only in Edge mode. Sets the measurement trigger for the percent amplitude digital measurement of gate 1 when in Edge detection mode (High Peak, 1stPeak).

- **G2 Mode/G2 RF/G2 %Amp:** Same settings as above, but for gate 2 only.
- **G2 Tracks:** Toggles tracking mode of gate 2 with respect to gate 1 on or off. Tracking ON is considered true echo-to-echo measurement mode.

Gate measurement modes, selected by **G1 Mode** or **G2 Mode**, determine which gated echo or echo parameters triggers a digital measurement.

- **Edge:** Acquires measurement readings based on the position of the first crossing point of a gated signal (see Figure 3-10 on page 72).
- **Peak:** Acquires measurement readings based on the highest peak within the gated region (does not have to cross the gate threshold). See Figure 3-10 on page 72.
- **1stPeak:** Acquires measurement readings based on the first peak to cross the gate threshold (level). See Figure 3-11 on page 73.
- **J-Flank:** Acquires thickness measurement readings based on the position of the first crossing point of a gated signal and amplitude measurement readings from the highest peak of the first echo in the gated region (see Figure 3-11 on page 73).

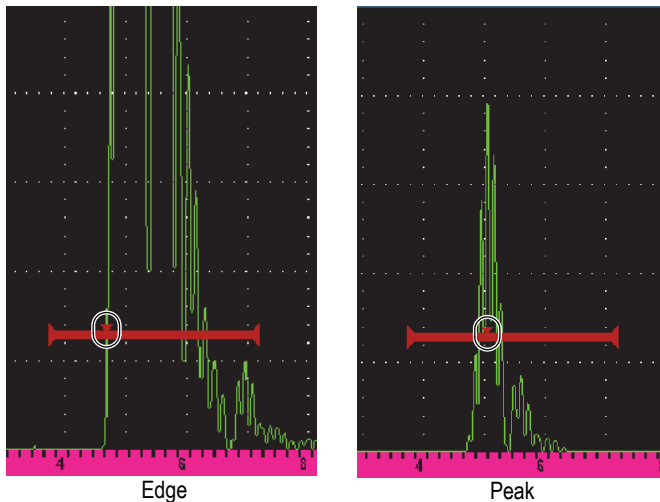


Figure 3-10 Trigger in Edge and Peak modes



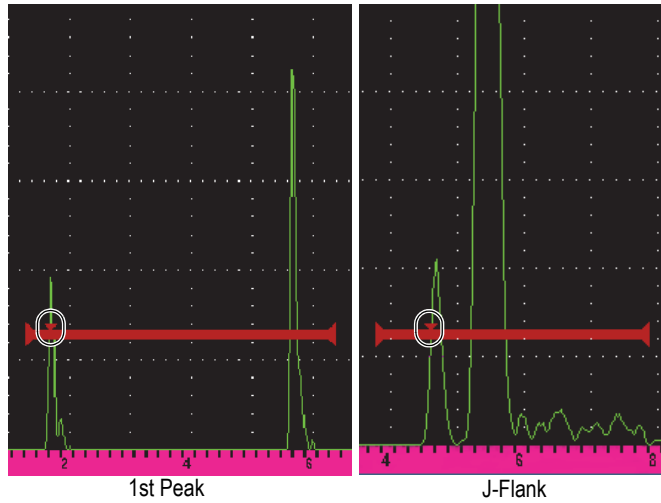


Figure 3-11 Trigger in 1stPeak, and J-Flank modes

### 3.10.4 Gate Alarm Indications

Whenever an alarm is triggered on either measurement gate, you are alerted in two different ways:

- The EPOCH 650 emits an audible tone
- One of two alarm indicators (LEDs) is illuminated on the instrument front panel (see Figure 3-12 on page 73).

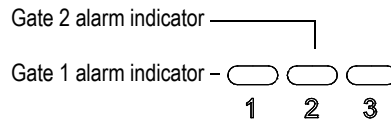


Figure 3-12 Gate 1 and gate 2 alarm indicator lights

---

<b>NOTE</b>
-------------

The EPOCH 650 is also capable of outputting alarm signals through the Digital Out connector on the back panel of the instrument (see “Alarm Outputs” on page 149).

---

## 3.11 Calibration

The EPOCH 650 can be easily calibrated for both zero offset and velocity in order to provide accurate thickness (sound path) measurements from indications. The EPOCH 650 utilizes an auto-calibration system for a simple, two-point approach. See “Calibration” on page 155 for more detailed calibration information.

### 3.11.1 Measurement calibration

Calibration for accurate digital measurements is typically accomplished using two known thicknesses of a representative material. In this section, the terms thin and thick are used to refer to either two thicknesses of a block or plate (straight beam calibrations) or two lengths of an angled sound path (angle beam calibration).

#### To begin calibration

1. Couple the transducer to the thin step of the material.
2. Position gate 1 around the resulting indication on screen.
3. Press 2<sup>ND</sup> F (AUTO XX%) to bring the indication to 80 % of full screen height.
4. Choose the **Auto Cal** menu item (see Figure 3-13 on page 75).

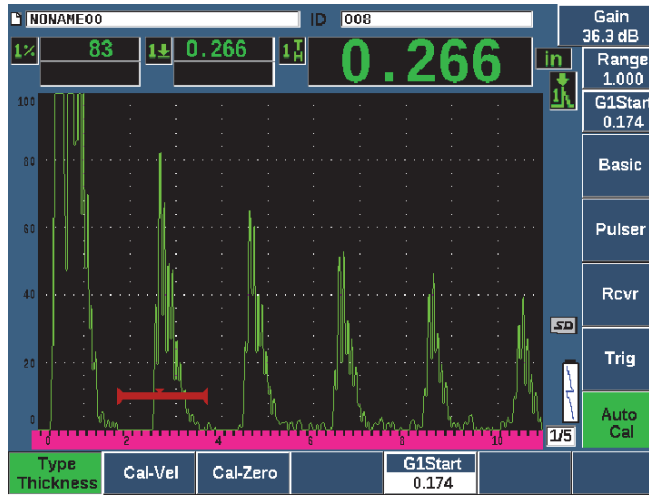


Figure 3-13 The Auto Cal menu

5. Select the **Type** parameter, then select the appropriate calibration type (**Thickness** for straight beam or **Soundpath** for angle beam are the most common).
6. Select **Cal-Zero**.
7. Adjust the displayed value to the appropriate thickness. For this example, the transducer is coupled to a 5 mm (0.200 in.) step (see Figure 3-14 on page 76).

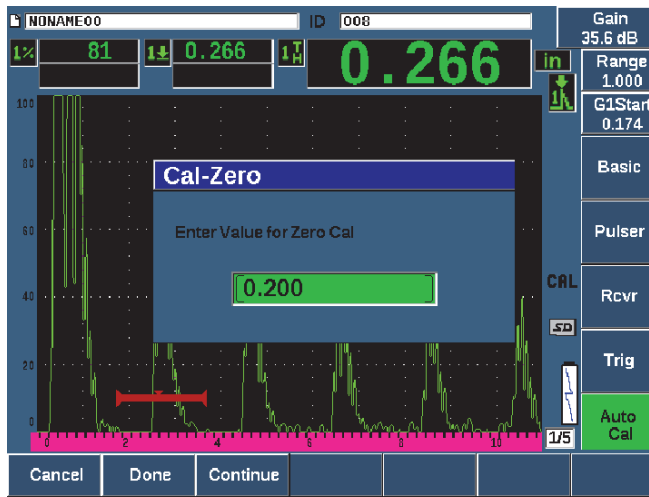


Figure 3-14 The Cal-Zero value

8. Select **Continue** to accept the adjusted value, and then move on to the second calibration step.
9. Couple the transducer to the thick step of material.
10. Position gate 1 around the resulting indication on screen.
11. Bring the indication to 80 % full screen height using the 2<sup>ND</sup> F, (AUTO XX%) keys (see Figure 3-15 on page 77).

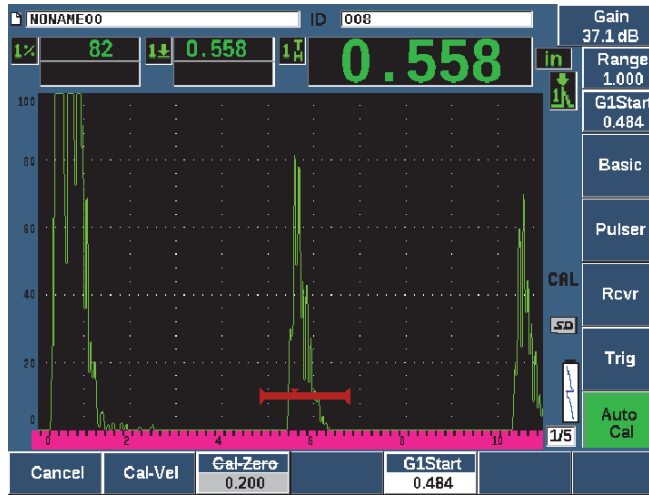


Figure 3-15 The gate 1 start

12. Select **Cal-Vel**.
13. Use the knob or arrow keys to adjust the displayed value to the appropriate thickness. For this example, the transducer is coupled to a 12.5 mm (0.500 in.) step (see Figure 3-16 on page 78).

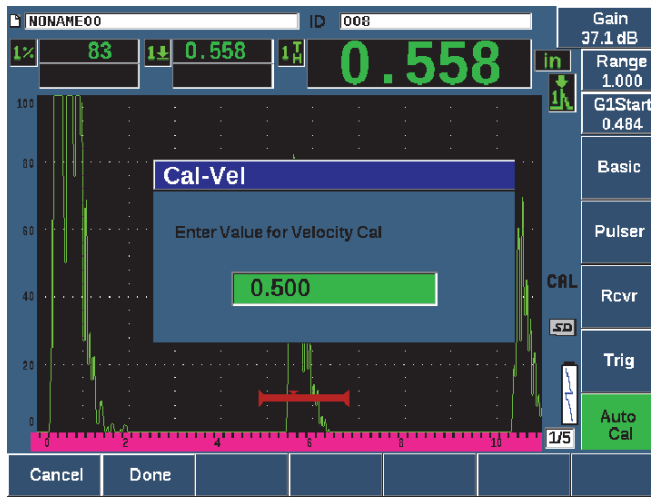


Figure 3-16 The Velocity Cal value

14. Select **Done** to accept the adjusted value and complete the calibration process.
15. Press RANGE, and then adjust the screen range to the desired setting (see Figure 3-17 on page 78).

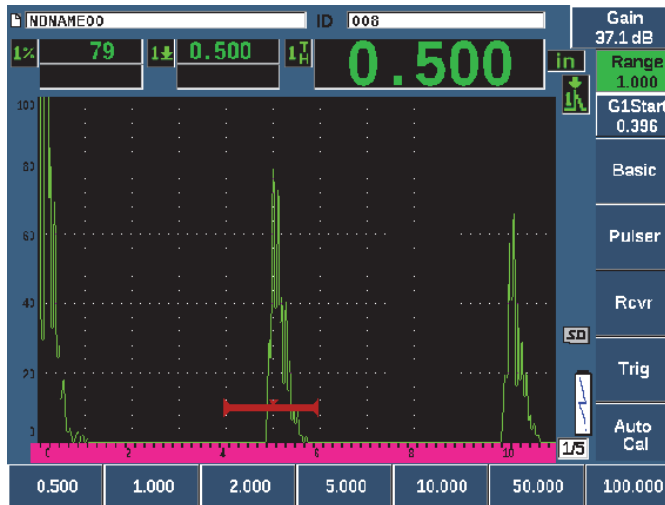


Figure 3-17 The Range value

## 3.11.2 Angle Beam Calibration

Angle beam calibrations typically require four steps.

### To perform an angle beam calibration

1. Locate the Beam Index Point (see “Locating the Beam Index Point” on page 177).
2. Verify the refracted angle of wedge (see “Verifying the Refracted Angle” on page 179).
3. Complete the distance calibration using “Measurement calibration” on page 74 (Calibration mode set to **SoundPath** or **Depth** depending on the reflector type).
4. Set the sensitivity using “Calibrating for Sensitivity” on page 185 (See Figure 3-18 on page 79).
  - Capture the sensitivity hole or notch in gate 1, bringing the indication to 80 % screen height using 2<sup>ND</sup> F, (AUTO XX%).
  - Set the reference gain by pressing 2<sup>ND</sup> F, (REF dB).

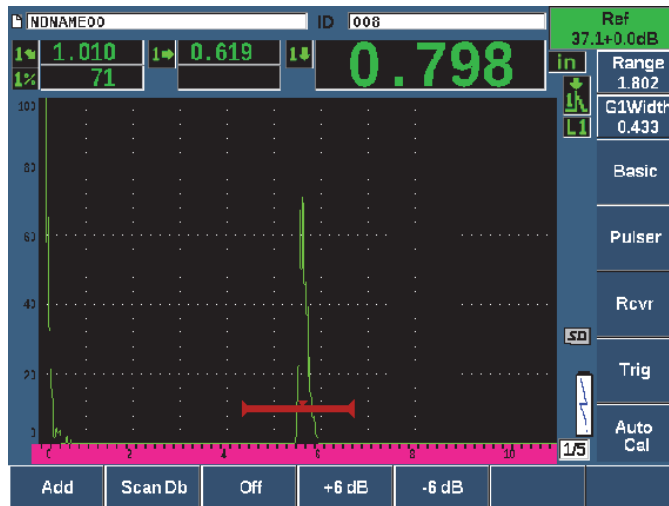


Figure 3-18 Reference gain setting

## 3.12 Data Logger

The EPOCH 650 features an onboard data logging system that allows standard storage of inspection files (Inc) and dedicated calibration files (Cal), as well as inspection files in corrosion style configurations (2D, 3D, Boiler, etc). Regardless of file type, each discrete data point saved on the EPOCH 650 stores all active digital measurements, compressed A-scans, calibration data, alarm conditions, and active software features. Two gigabytes of onboard memory allows storage of over 100,000 individual data points.

The section below outlines the procedure for setup and storage of the most basic and common file type, the calibration file. For full details and procedures on standard and optional file types, see “Data Logger” on page 199.

### 3.12.1 Calibration Files

To setup and save a calibration file on the EPOCH 650, first complete all ultrasonic and software setups that will be saved within the calibration.

#### To create and store a calibration file

1. Select the **File** menu item.
2. Select the **Create** parameter (see Figure 3-19 on page 81).
3. In the **File Type** box, use the knob or arrow keys to select **Cal**.
4. Press NEXT to advance to the **Filename** box.
5. Select the **Edit** parameter to display the virtual keypad (see Figure 3-19 on page 81).
6. Use the knob or arrows to navigate through the virtual keypad and create a file name (32 characters maximum).
7. Insert a character by selecting **INS** (the F5 key).



Figure 3-19 The Create screen with virtual keypad

8. Press NEXT to complete the file naming process.

---

**NOTE**

For creation of an incremental (Inc) file, you must first create a Start Point.

---

9. Press NEXT until the **Create** button is highlighted.
10. Select the **&Save** parameter.

The **&Save** parameter creates the file in memory, opens it as the active storage location, then prompts you to save the current file parameters to the file (see Figure 3-20 on page 82).

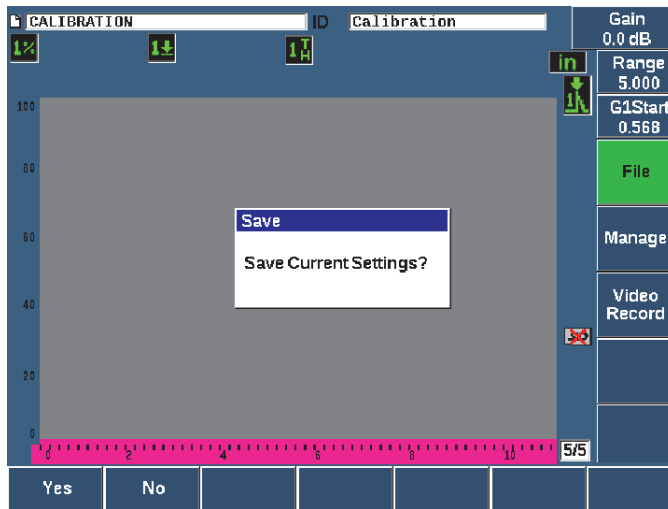


Figure 3-20 The Save dialog box

Two other file creation parameters are available and described below:

- **Create:** Creates the file in memory but does not open this file as the active storage location. Typically used when creating several files at once without saving data.
- **&Open:** Creates the file in memory, and then opens it as the active storage location, but does not save any file parameters to the file until you press 2<sup>ND</sup> F, (SAVE). This is typically used for inspection files, where the file is created before the start of the inspection.

11. Press **YES** (P1 key) to accept the function and return to the live screen.

### 3.12.2 Resetting the Instrument

The EPOCH 650 allows you to reset its current settings to default values. This capability is useful if you want to reset the instrument parameters, delete all the data logger files, or reset the instrument back to its factory settings.

#### To reset the EPOCH 650

1. Choose **Manage > Reset** to display the **Resets** page (see Figure 3-21 on page 83).

2. Use the arrow keys or the adjustment knob to highlight a reset type and press **Select** (P1 key).

Available reset types are:

- **Parameters reset**  
Resets only the current on-screen parameters to system default values (does not affect saved files).
- **Storage Reset**  
Deletes all saved files with no effect on live instrument settings. (Only the default NONAME00 file will remain.)
- **Master Reset**  
Resets all live settings to factory defaults and deletes all saved files.
- **Power Down**  
Used to turn off the instrument.

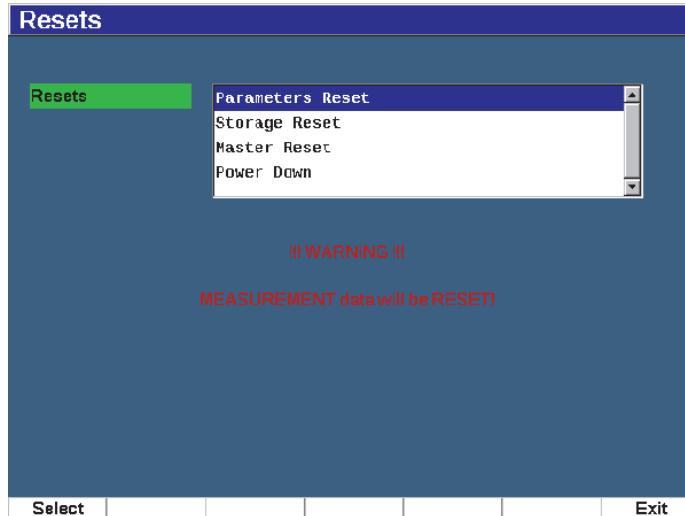
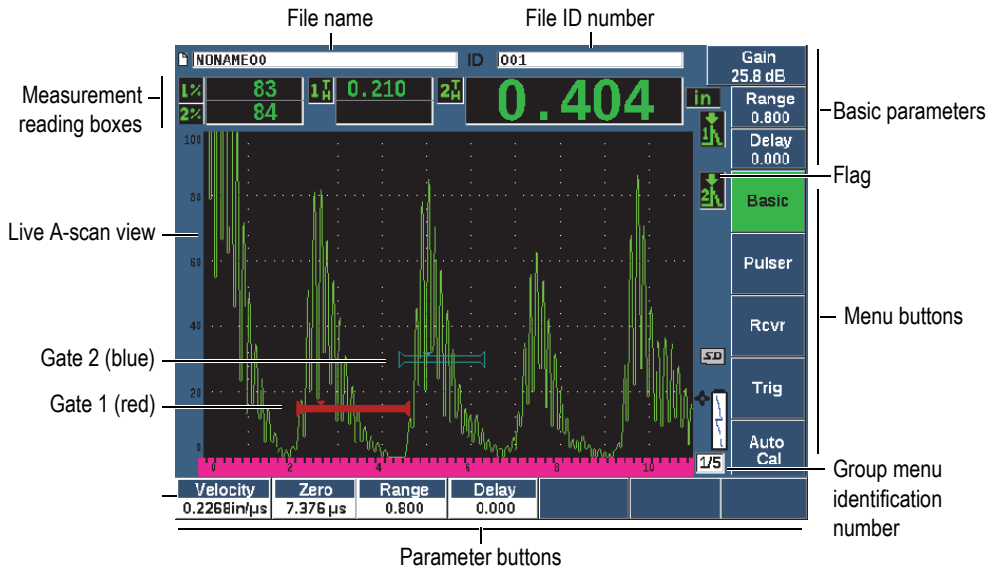


Figure 3-21 The Resets page



## 4. Software Interface

The EPOCH 650 software main display is shown in Figure 4-1 on page 85.



**Figure 4-1 Software main display elements**

For information on selecting functions and parameters, see “Software Overview” on page 61 through “Submenus” on page 66

The main display in full screen mode is shown in Figure 4-2 on page 86.

## To change the size of the main display

Press 2<sup>ND</sup> F (FULL), to set the main display to full screen mode.


Press the Escape key , to revert from the full screen to normal screen size.

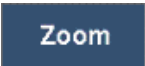


Figure 4-2 Software display elements in full screen mode




## 4.1 Button Types

Table 4 on page 86 shows the various types of buttons found in the EPOCH 650 ultrasonic flaw detector interface.

Table 4 Button types

Type	Example	Description
Function		Function menu item that immediately executes a command when selected.

**Table 4 Button types (continued)**

Type	Example	Description
Submenu		Function menu item that opens a dialog box or a screen with more parameters.
Editable value		Parameter with an editable value. Turn the adjustment knob or press the arrow keys to change the value.
Selectable value		Parameter with a set of predetermined selectable values. Turn the adjustment knob or press the arrow keys to select the value.


## 4.2 File Identifier and Message Bars

The file identifier bar appears at the top of the main display and shows the name of the currently opened file, and the identifier (see example in Figure 4-3 on page 87).



**Figure 4-3 File identifier bar with ID example**

The message bar appears at the bottom of the screen displaying messages and notifications as needed, following your actions (see example in Figure 4-4 on page 87).



Operation successful...

**Figure 4-4 Message bar with a message example**

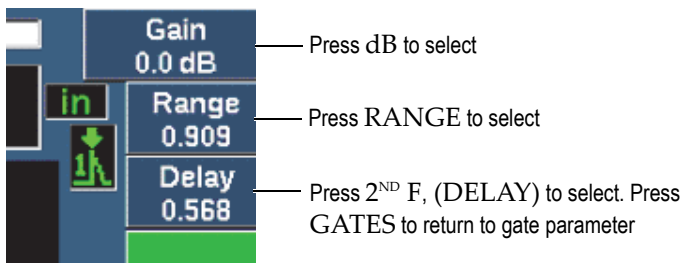
## 4.3 Direct-Access Parameters

Direct-access parameters always appear at the top right corner of the display window. This allows you to view these parameters from the main screen regardless of which menu or parameter you are currently accessing. These parameters include **Gain**, **Range**, **Delay**, and **Gates**.

### To select and view the direct-access parameters

- Press the dB direct-access key to select the **Gain** parameter.
- Press the RANGE direct-access key to select the **Range** parameter.
- Press the GATES direct-access key to select the **Gate** parameters. The **G1Start** parameter replaces the **Delay** parameter.
- Press the 2<sup>ND</sup> F (DELAY) direct-access key to select the Delay parameter.

Once selected, the button turns green (see Figure 4-5 on page 88). Turn the adjustment knob or press the Up and Down arrow keys to edit the value. For additional information on gate adjustment, see “Quickly Adjusting Basic Gate Parameters” on page 137.



**Figure 4-5 Example of the Gain, Range, and Delay direct-access parameters**

When you are using the gain, range, or delay direct access keys, a set of preset values display over the parameter keys at the bottom of the screen (see Figure 4-6 on page 89). These preset values allow you to jump to a particular setting with a single button press, and can be customized (see “Editable Parameters Page” on page 114).



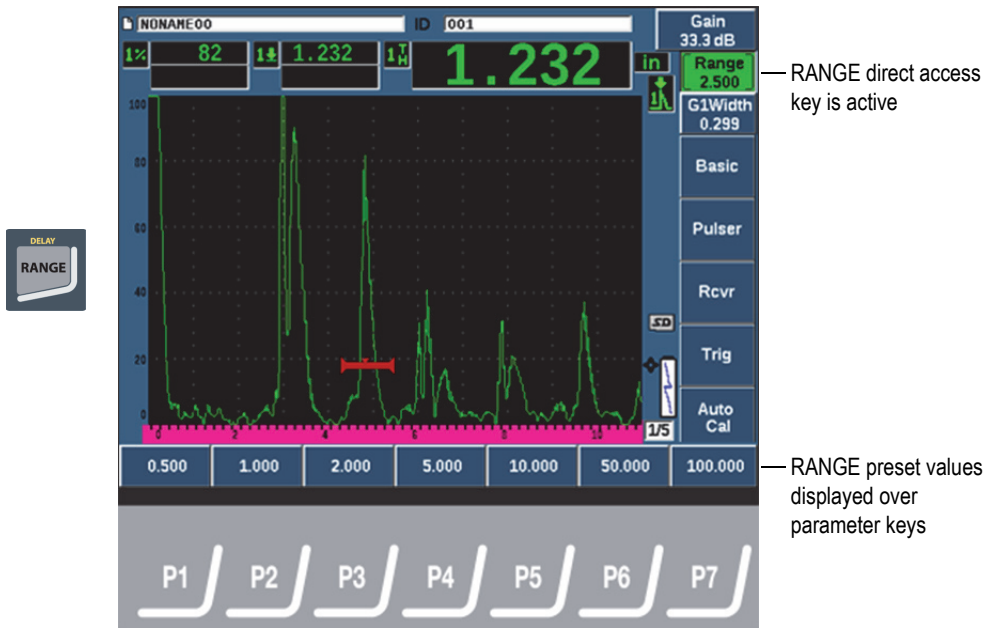


Figure 4-6 Direct access preset values

## 4.4 Measurement Reading Boxes

The measurement reading boxes at the top-left corner of the software main display present the icons and digital values for up to five selectable measurements (see Figure 4-7 on page 89). See “Reading Setup Page” on page 103 for details on how to select measurements and for a description of available measurements.

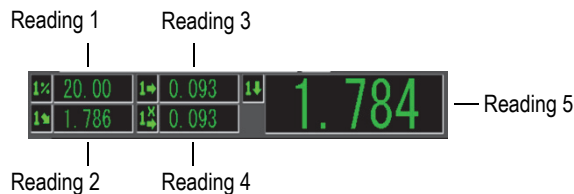


Figure 4-7 Example of measurement reading boxes with their icons

## 4.5 Live-Scan Area

The large fixed-size live-scan area displays the ultrasonic data graphically (see Figure 4-8 on page 90).



Figure 4-8 Example of an A-scan waveform with gates







## 4.6 Flags

The EPOCH 650 ultrasonic flaw detector indicates when particular functions are active by displaying a set of flags, in a thin vertical area on the right of the live-scan area (see Figure 4-9 on page 91). Table 5 on page 91 provides a description of the possible flags.



Figure 4-9 The area displaying flags

Table 5 Flag description

Flag	Description
	Length units are inches
	Length units are millimeters
	Length units are microseconds
	Indicates that the 2 <sup>ND</sup> F key has been pressed.
	Gate 1 is in peak measurement mode.
	Gate 2 is in peak measurement mode.

**Table 5 Flag description (continued)**






























Flag	Description
	Gate 1 is in edge (or flank) measurement mode.
	Gate 2 is in edge (or flank) measurement mode.
	Gate 1 is in first-peak measurement mode.
	Gate 2 is in first-peak measurement mode.
	The IF gate is in J-Flank measurement mode.
	Gate 1 is in J-Flank measurement mode.
	Gate 2 is in J-Flank measurement mode.
	DAC is active.
	DGS is active.
	AWS is active.
	API 5UE is active.
	Template Storage is active.

Table 5 Flag description (continued)

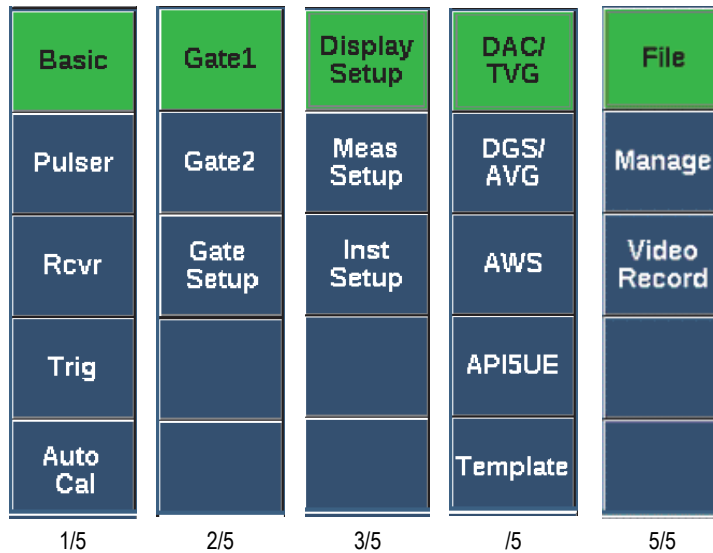
Flag	Description
	Calibration is active.
	Curved surface correction (CSC) is active.
	B-scan is active.
	Gate tracking (Echo-to-Echo) is active.
	Zoom is active.
	FREEZE is active.
	Auto FREEZE is active.
	PEAK MEM is active.
	2 <sup>ND</sup> F, (PEAK HOLD) reference echo is active.
	Waveform averaging is active.
	Access to all instrument functions except ON/OFF is locked.
	Indicates that a microSD card is installed.
	Indicates that the microSD card is not installed.
	Current settings are restricting waveform update rate below 60 Hz.

**Table 5 Flag description (continued)**

Flag	Description
	Indicates that the charger is connected and charging the battery.
	Indicates that the instrument is running off of battery power.
	Indicates that video record mode is actively acquiring a video.

## 4.7 Menu Contents

The EPOCH 650 ultrasonic flaw detector uses menus to categorize similar functions. It includes five menu groups shown in Figure 4-10 on page 95.



**Figure 4-10 Standard menu groups**

Table 6 on page 95 to Table 10 on page 97 provides a quick reference of available menus and parameters for each menu group.

**Table 6 Content of the first menu group**

Menus	Parameters						
<b>Basic</b>	Velocity	Zero	Range	Delay			
<b>Pulser</b>	PRF Mode	PRF	Energy	Damp	Mode	Pulser	Freq
<b>Rcvr</b>	Filter	Rect					Reject
<b>Trig</b>	Angle	Thick	X Value	CSC			
<b>Auto Cal</b>	Type	Cal-Vel	Cal-Zero		G1Start		

**Table 7 Content of the second menu group**

<b>Menus</b>	<b>Parameters</b>						
<b>Gate 1</b>	Zoom	Start	Width	Level	Alarm	Min Depth (only when Alarm is set to Min Depth)	Status
<b>Gate 2</b>	Zoom	Start	Width	Level	Alarm	Min Depth (only when Alarm is set to Min Depth)	Status
<b>Gate Setup</b>	G1 Mode	G1 RF	G1 %Amp	G2 Mode	G2 RF	G2 %Amp	G2 Tracks

**Table 8 Content of the third menu group**

<b>Menus</b>	<b>Parameters</b>						
<b>Display Setup</b>	Display Setup	Grid					
<b>Meas Setup</b>	Reading Setup	Unit	TH Res	% Res	A-Out	Special	AutoXX %
<b>Inst Setup</b>	General	About	Clock	Software Options	Misc	Edit Parameters	

**Table 9 Content of the fourth menu group**

<b>Menus</b>	<b>Parameters</b>						
<b>DAC/TCG</b>	Add (setup mode) DAC Gain (inspect mode)	Delete (setup mode) View (inspect mode)	Done (inspect mode)	Gain Step (inspect mode)	G1Start	Edit (inspect mode)	Setup



**Table 9 Content of the fourth menu group (continued)**

<b>Menus</b>	<b>Parameters</b>						
<b>DGS/AVG</b>	Ref (setup mode) Delta VT (inspect mode)	Reg Level (inspect mode)		ACV Spec (inspect mode)	G1Start		Setup
<b>AWS</b>	Ref B	Scan dB	Ref Level (inspect mode)		G1Start		Setup
<b>API5UE</b>	RefAMax (setup mode) Collect (setup mode, Peak Mem active, and inspect mode)	RefT1 (setup mode)	RefT2 (setup mode)	G1Start	Inspect (setup mode, data collected) Re-Cal (inspect mode)	Clear (setup mode, data collected)	Setup
<b>Template</b>	Template1 (inspect mode)	Template2 (inspect mode)	Template3 (inspect mode)	Template4 (inspect mode)	Template5 (inspect mode)	Template6 or right arrow (inspect mode)	Setup

**Table 10 Content of the fifth menu group**

<b>Menus</b>	<b>Parameters</b>						
<b>File</b>	Open	Create	Thick Record	Quick Recall	Memo	Last ID	Select ID
<b>Manage</b>	Reset	Export	Import	Edit	Copy	Delete	Import Memo
<b>Video Record</b>	Record (setup mode)	Frames (setup mode) Pause (record mode)		Flag (record mode)	Save (setup mode)	Video Files (setup mode)	Setup

**To choose a menu group, a menu, and a parameter value**

1. Press NEXT to select a menu group.

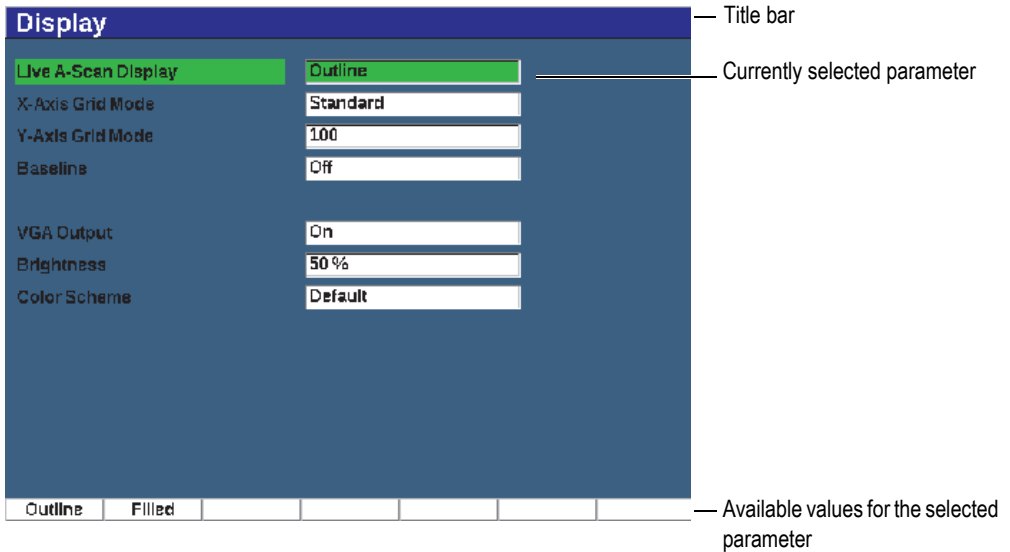
2. Select a menu item using the corresponding function key. The menu indicator identifies the selected menu (see “Menu Contents” on page 94 for details on the menu structure).
3. Select the parameter you want using the corresponding parameter key.

### **To change the value of a parameter**

1. Choose the value by selecting the corresponding parameter.  
The button background of the selected parameter turns to green, showing that it is selected.
2. Use the arrow keys or turn the adjustment knob to change the value (see “Parameter Adjustment” on page 64).  
The edited value is immediately effective. Note that some parameters have a fixed value or state.

## **4.8 Setup Pages**

The EPOCH 650 ultrasonic flaw detector software includes a number of setup pages allowing you to adjust instrument features and parameters to your preferences. The Display setup page shown in Figure 4-11 on page 99, is an example of a setup page.



**Figure 4-11 The Display setup page and its elements**

A title bar identifies the type of setup page. Parameters appear with the parameter label on the left and its current value and units (if applicable) on the right. Seven button fields at the bottom of the page may contain available values for the currently selected parameter.

### To navigate in a setup page

1. Access the setup page you want using the appropriate function and parameter.
2. Press NEXT to select the field or parameter to modify.
3. Use the arrow keys or turn the adjustment knob to change the value.  
The edited values are effective immediately.

## 4.8.1 Entering an Alphanumeric Value Using the Virtual Keyboard

A setup page containing one or more parameters with alphanumeric values also contains a virtual keyboard. The virtual keyboard allows you to enter alphanumeric characters without having to use a USB keyboard.

## To enter an alphanumeric value using the virtual keyboard

1. Access a setup page that contains parameters with alphanumeric values (see the example of Figure 4-12 on page 100).

The screenshot shows a software interface titled "Edit". At the top, there is a section labeled "\*Select File" with a "Total: 4" indicator. Below this is a list of four items:

[1]	COLETHCK1	INC	
[2]	CORRSN-2D	CAL	10/06/14
[3]	DGS-DL1	SEQ	10/07/14
[4]	NUNANE00	INC	01/01/14

Below the list is a section labeled "\*Filename" with a green highlight. The "Filename" field contains "CORRSN-2D". Below it are fields for "Description", "Inspector ID", and "Location Note", all of which are currently empty. A virtual keyboard is overlaid on the bottom right of the form, showing letters A through Z, numbers 0 through 9, and symbols like hyphen, hash, and slash. The letter 'A' is highlighted in green. To the right of the keyboard are several function keys: a double arrow key, a 'Y' key, a 'Y' key with a vertical line, a 'DEL' key, and an 'INS' key. At the bottom of the screen, there is a row of buttons, with the first one labeled "Edit".

Figure 4-12 The Edit page with its virtual keyboard

2. Select the field that you want to edit using the NEXT button, and then choose Edit.
3. On the virtual keyboard:
  - a) Move the cursor on the character to be added by using the arrow keys or by turning the adjustment knob.
  - b) Select **INS** (F5 key).
4. Repeat step 3 to enter other characters.
5. To delete an already entered character:
  - a) Move the cursor on the character to be deleted by pressing the double arrow (F1) or (F2) keys.
  - b) Select **DEL** (F4 key).
6. To save the entered data and exit the setup page, press NEXT until the **Apply** or **Create** button is selected, and then press P1.

## 4.8.2 Display Setup Page

The Display setup page allows you to set parameters that control aspects of the display (see Figure 4-13 on page 101).

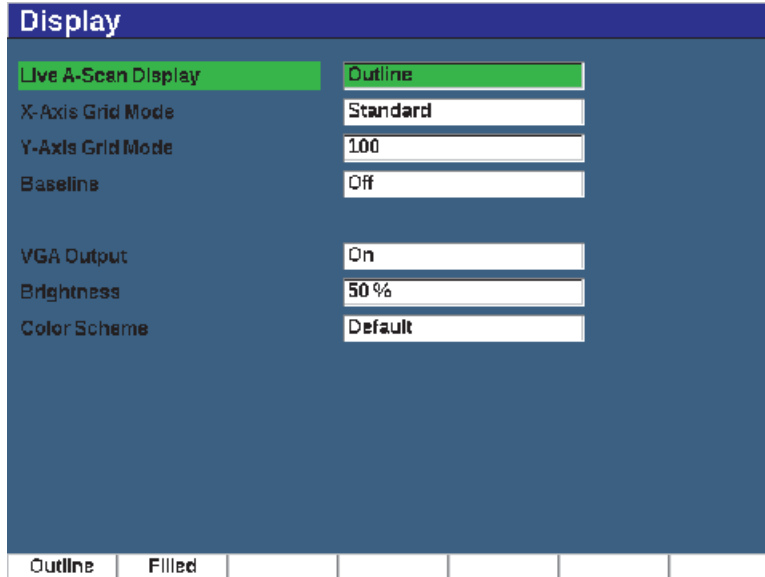


Figure 4-13 The Display setup page

### To use the Display setup page

1. Choose **Display Setup** (group 3/5).
2. Press **Display Setup** (P1 key).
3. Select the parameter you want to set up.

The available parameters are:

- **Live A-Scan Display**  
Sets the live A-scan drawing mode
  - **Outline**
  - **Filled**

**NOTE**

Envelope drawing mode is always opposite the selected Live A-Scan drawing mode.

---

- **X-Axis Grid Mode**

Sets the horizontal X-axis grid display mode

- **Off:** no grid
- **Standard:** 10 divisions spaced evenly and labeled 1 to 10
- **Soundpath:** five divisions spaced evenly and labeled with corresponding sound path values
- **Leg:** up to four divisions representing half-skip distances in angle beam inspection mode, based on test piece thickness value, and labeled L1 to L4

- **Y-Axis Grid**

Sets the vertical Y-axis grid display mode to 100 % or 110 % full screen height

- **Baseline (Baseline Break)**

Modifies the appearance of the A-scan in full wave rectified mode. When active, the instrument locates all zero cross points in the RF waveform and pulls the full wave rectified A-scan to the baseline. This feature helps to see small defects that are close to the back surface of the test piece, especially at large ranges.

- **On:** Baseline Break enabled
- **Off:** Baseline Break disabled

- **VGA Output**

Controls the output to the VGA connector.

- **On**
- **Off**


- **Brightness**

Used to adjust the screen brightness or by choosing one of the preset values (0 %, 25 %, 50 %, 75 %, or 100 %).

- **Color Scheme**

Sets the overall instrument color scheme

- **Default:** default multi color display
- **Classic:** EPOCH 600 color scheme
- **Outdoor W:** white background, black text

- **Outdoor Y:** yellow background, blue text
  - **Mono:** Black background, white text
4. Press  to return to the live screen.

### 4.8.3 Grid Setup Page

The Grid setup page allows you to activate and set up the Grid View feature for visualization of data collection in the live A-scan screen. For more information on the setup and use of the Grid View feature, see “Grid View” on page 229.

### 4.8.4 Reading Setup Page

The Reading setup page, shown in Figure 4-14 on page 103, allows you to select which measurement appears in the measurement reading boxes at the top of the software main display.

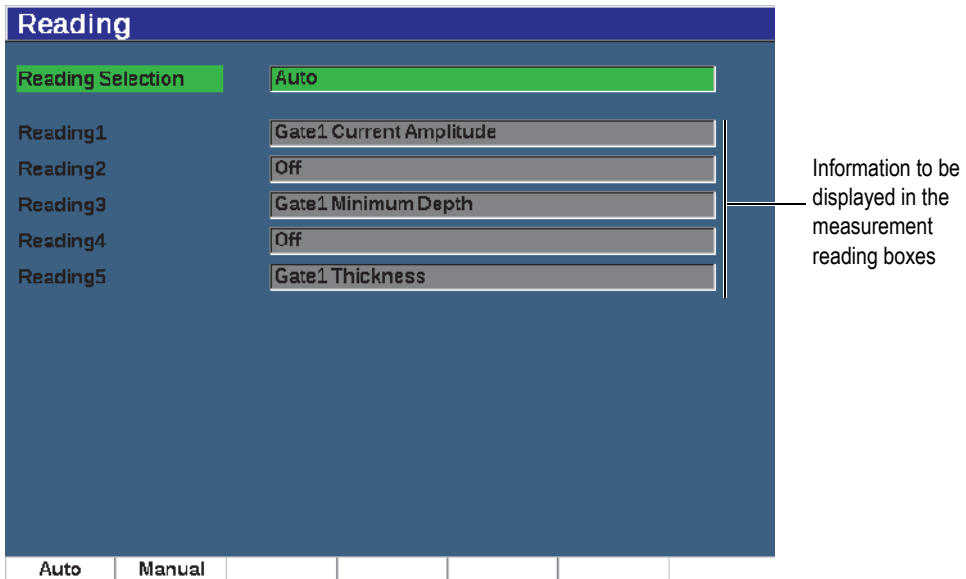


Figure 4-14 The Reading setup page

## To use the Reading setup page

1. Choose **Meas Setup** (group 3/5).
2. Press **Reading Setup** (P1 key).
3. Select the parameter you want to set up.
  - **Reading Selection**  
Sets the measurement reading box mode.
    - **Auto:** Automatically makes the selection based on instrument function
    - **Manual:** Readings correspond to the manually defined selections
  - **Reading1 to Reading5**  
Each measurement reading box is defined independently when in manual mode. Figure 4-14 on page 103 shows an example of the measurement reading boxes and icons that indicate what type of measurement is being displayed. Table 11 on page 104 presents the available measurement readings.

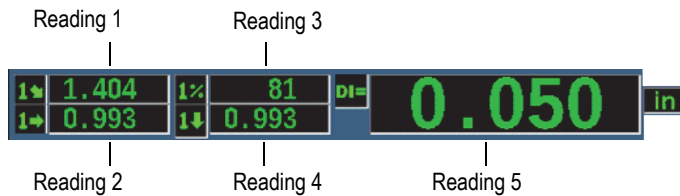


Figure 4-15 Example of measurement reading boxes with icons

Table 11 Available measurement readings

Icon	Measurement reading	Description
	Gate 1 Thickness	Thickness in gate 1. Not used with Angle.
	Gate 2 Thickness	Thickness in gate 2. Not used with Angle.
	Gate 1 Soundpath Distance	Sound Path (Angular) distance in gate 1.
	Gate 2 Soundpath Distance	Sound Path (Angular) distance in gate 2.



**Table 11 Available measurement readings (continued)**



































Icon	Measurement reading	Description
	<b>Gate 1 Depth to Reflector</b>	Depth to reflector in gate 1. Used with Angle.
	<b>Gate 2 Depth to Reflector</b>	Depth to reflector in gate 2. Used with Angle.
	<b>Gate 1 Surface Distance</b>	Horizontal distance to reflector in gate 1. Used with Angle.
	<b>Gate 2 Surface Distance</b>	Horizontal distance to reflector in gate 2. Used with Angle.
	<b>Gate 1 Surface Dist – x Val</b>	Horizontal distance minus X-Value (distance from beam index point to front of wedge) in gate 1. Used with Angle.
	<b>Gate 2 Surface Dist – x Val</b>	Horizontal distance minus X-value (distance from beam index point to front of wedge) in gate 2. Used with Angle.
	<b>Gate 1 Minimum Depth</b>	Minimum depth in gate 1. Resets on gate adjustment and on most pulser/receiver adjustments.
	<b>Gate 2 Minimum Depth</b>	Minimum depth in gate 2. Resets on gate adjustment and on most pulser/receiver adjustments.
	<b>Gate 1 Maximum Depth</b>	Maximum depth in gate 1. Resets on gate adjustment and on most pulser/receiver adjustments.
	<b>Gate 2 Maximum Depth</b>	Maximum depth in gate 2. Resets on gate adjustment and on most pulser/receiver adjustments.
	<b>Gate 1 Current Amplitude</b>	Amplitude measurement in gate 1. Displays as % of full-screen height (FSH).
	<b>Gate 2 Current Amplitude</b>	Amplitude measurement in gate 2. Displays as % of full-screen height (FSH).
	<b>Gate 1 Maximum Amplitude</b>	Maximum amplitude in gate 1. Resets on gate adjustment and on most pulser/receiver adjustments.

Table 11 Available measurement readings (*continued*)

Icon	Measurement reading	Description
	Gate 2 Maximum Amplitude	Maximum amplitude in gate 2. Resets on gate adjustment and on most pulser/receiver adjustments.
	Gate 1 Minimum Amplitude	Minimum amplitude in gate 1. Resets on gate adjustment and on most pulser/receiver adjustments.
	Gate 2 Minimum Amplitude	Minimum amplitude in gate 2. Resets on gate adjustment and on most pulser/receiver adjustments.
	Gate 1 Amplitude to Curve	Amplitude measurement in gate 1. Displays echo height as a percentage of DAC/TCG curve height.
	Gate 2 Amplitude to Curve	Amplitude measurement in gate 2. Displays echo height as a percentage of DAC/TCG curve height.
	Gate 1 dB to Curve	Amplitude measurement in gate 1. Displays echo dB value compared to curve height where the curve equals 0 dB.
	Gate 2 dB to Curve	Amplitude measurement in gate 2. Displays echo dB value compared to curve height where the curve equals 0 dB.
	Gate 2–Gate 1 (Echo-to-Echo)	Gate 2 thickness minus gate 1 thickness (echo-to-echo measurement).
	AWS D1.1/D1.5 Weld Rating (D)	D rating calculated for the gated echo.
	Equivalent Reflector size	Equivalent reflector size (flat-bottom hole) for DGS/AVG evaluation
	Overshoot (OS)	Overshoot value in dB comparing echo height to DGS/AVG curve.
	API5UE Depth	Imperfection size (crack height) calculated from API 5UE inspection procedure.
	AWS A	AWS defect indication value A.

**Table 11 Available measurement readings (continued)**

Icon	Measurement reading	Description
	AWS B	AWS reference indication value B.
	AWS C	AWS sound path correction value C.
	Gate1 Ref dB-Current Amp	Comparison value in dB measuring the difference between the gate 1 echo height and the reference gain.
	Gate2 Ref dB-Current Amp	Comparison value in dB measuring the difference between the gate 2 echo height and the reference gain.
	Gate1 – IF Gate	Gate 1 thickness minus interface gate thickness (echo-to-echo measurement).
	Gate2 – IF Gate	Gate 2 thickness minus interface gate thickness (echo-to-echo measurement).
	GateIF Thickness	Thickness in interface gate. Not used with Angle.

4. Press  to return to the live screen.

#### 4.8.5 General Setup Page

The General setup page, shown in Figure 4-16 on page 108, allows you to configure general parameters such as the user interface language and the instrument date mode.

General Setup	
Language	English
Filter Group	Standard
Key Beep	Off
Alarm Beep	On
Cal Lock	Off
Radix Type	Period(.)
Date Mode	mmdd/yyyy
File Open & Recall	Off
Communications Protocol	Multi Char
Communications Device	RS232
Baud Rate	19200
Test	Off
Corrosion Gage	Off
English	

Figure 4-16 The General Setup page

### To use the General setup page

1. Choose **Inst Setup** (group 3/5).
2. Press **General** (P1 key).
3. Select the parameter you want to set up:
  - **Language**  
Used to select the user interface language (**English, Japanese, German, French, Spanish, Russian, and Chinese**).
  - **Filter Group**  
Used to select receiver filter group.
  - **Key Beep**  
Sounds an audible tone on every key press.
  - **Alarm Beep**  
Used to activate an audible tone when a Gate Alarm is triggered.
  - **Cal Lock**  
Used to lock access to all functions affecting calibration/waveform data. These include: Basic, Pulser, Rcvr (receiver), and Trig settings, as well as Gain,

Range, and Delay. These parameters are crossed out when the Cal Lock function is turned **On**.

- **Radix Type**

Used to select the format used by the instrument to display numeric values (radix) and the date.

- **Date Mode**

Used to set the date format. You can choose between the **dd/mm/yyyy** and **mm/dd/yyyy** formats.

- **File Open & Recall**

- **On**
- **Off**

- **Communications Protocol**

Used to select command type for remote/PC communication with the instrument (Multi Char or Single Char). When communication with the Evident GageView Pro PC software, Multi Character mode must be selected.

- **Communications Device**

Used to select the type of remote/PC communication (USB or RS-232). When communication with the Evident GageView Pro PC software, USB mode must be selected.

- **Baud Rate**

Activated only when you select RS232 in the Communications Device box. Baud rate on instrument must match baud rate on PC.

- **2400**
- **9600**
- **19200**
- **38400**
- **57600**
- **115200**


- **Test**

- **On**
- **Off**

- **Corrosion Gage**

Enables or disables the optional corrosion gage software.

- **On**
- **Off**

4. Press  to return to the live screen.

## 4.8.6 About Page

The **About** page provides information about the instrument hardware and software identification data (see Figure 4-17 on page 110).

About							
Model Name	Epoch 600						
Build Date	10/09/2014						
SW Version	1.00G						
Das Version	PCB:0/DAS:25.9047						
Language File	LangEP600_201.bin File missing						
Memory	free=0x8000, free block=0x8000						
Gage S/N	013D-6DEA-93EE-31B4						
Instrument S/N							
Original Date of Manufacture	04/04/2013						
Run Time	59Hr49Min						
Power Ups	626						
Initial Power Ups Date	01/01/2013						
<table border="1"> <tr> <td>Batt&amp;Temp</td> <td>Regulatory</td> <td>Licenses</td> <td></td> <td>Upgrads</td> <td></td> </tr> </table>		Batt&Temp	Regulatory	Licenses		Upgrads	
Batt&Temp	Regulatory	Licenses		Upgrads			

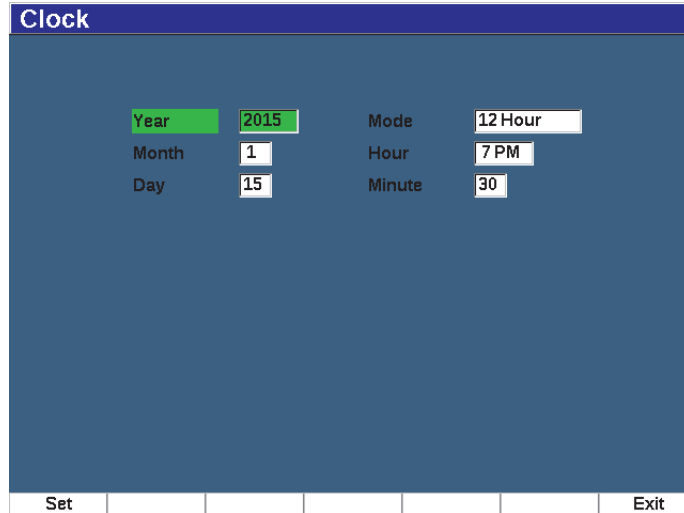
Figure 4-17 The Status setup page

The **About** page has four sub-pages:

- **Battery Status**  
Provides information about the battery and the gage.
- **Regulatory**  
Displays regulatory information and labels.
- **Licenses**  
Displays all the licensing information
- **Upgrade**  
Allows you to upgrade the EPOCH 650 system software. See “Maintenance and Troubleshooting” on page 309 for more information on upgrading your EPOCH 650 instrument software.

## 4.8.7 Clock Setup Page

The Clock setup page, shown in Figure 4-18 on page 111, allows you to configure the date and time settings for the instrument.



The screenshot shows a 'Clock' setup page with a dark blue background. At the top, there is a title bar labeled 'Clock'. Below it, there are six input fields arranged in two columns. The left column contains 'Year' (with a green highlight), 'Month', and 'Day'. The right column contains 'Mode', 'Hour', and 'Minute'. At the bottom of the page, there is a navigation bar with 'Set' and 'Exit' buttons.

Year	2015	Mode	12 Hour
Month	1	Hour	7 PM
Day	15	Minute	30

Set      Exit

Figure 4-18 The Clock setup page

### To use the Clock setup page

1. Choose **Inst Setup** (group 3/5).
2. Press **Clock** (P3 key).
3. Select the parameter you want to set up:
  - **Year**  
Used to set the year for the instrument internal clock.
  - **Month**  
Used to set the month for the instrument internal clock.
  - **Day**  
Used to set the day of the month for the instrument internal clock.
  - **Mode**  
Used to set the hour display mode (12 Hour or 24 Hour) for the instrument internal clock.

- **Hour**  
Used to set the hour for the instrument internal clock.
  - **Minute**  
Used to set the minutes for the instrument internal clock.
4. Press **Set** (P1) key to save the parameters.

## 4.8.8 Software Options Setup Page

The Software Options page allows you to enter an activate code to allow access to a software option not included with the standard package of instrument features. This is provided by an Evident representative after the purchase of a particular software option. See “Defining Licensed and Unlicensed Software Features” on page 237 for details on software option activation.

## 4.8.9 Misc Setup Page

The Misc (miscellaneous) page allows you to perform imports and exports of instrument files such as language support files, DGS/AVG custom probe files and XML schema files. The Misc page also allows you to perform a batch backup or restoration of the entire data logger to archive or clone data from a particular instrument.

### To use the Misc page

1. Choose **Inst Setup** (group 3/5).
2. Press **Misc** (P5 key).
3. Use the arrow keys or adjustment knob to select the action you want to initiate.
4. Press **Start** to initiate the selected action.

Following are the available actions:

- **Copy Language Bin File from External SD Card**  
Imports a language file from the microSD card to internal memory to update user interface translations.
- **Copy Language Bin File to External SD Card**  
Exports current language file from internal memory to the microSD card.
- **Copy XML Schema File from External SD Card**



Imports XML Schema file from the microSD card to internal memory to support file exports in the XML format (see “Manage Menu” on page 220 for more information on XML files).

- **Copy XML Schema File to External SD Card**

Exports the current XML Schema file from internal memory to the microSD card (see “Manage Menu” on page 220 for more information on XML files).

- **Copy DGS Custom Probe File from External SD Card**

Imports new custom DGS/AVG probe library from the microSD card to internal memory (see “DGS/AVG” on page 252 for more information).

- **Copy DGS Custom Probe File to External SD Card**

Exports current DGS/AVG custom probe library from internal memory to the microSD card (see “DGS/AVG” on page 252 for more information).

- **Backup from Internal to External SD Card**

Backs up all data logger files and live instrument settings to a single file on the microSD card for data archiving or instrument cloning.

- **Restore from External SD Card to Internal**

Restores all data logger files and live instrument settings from the microSD card to internal memory from a previously backed up file.

---

<b>IMPORTANT</b>
------------------

**Restore** permanently overwrites all existing data on the EPOCH 650 with data from the microSD card.

---

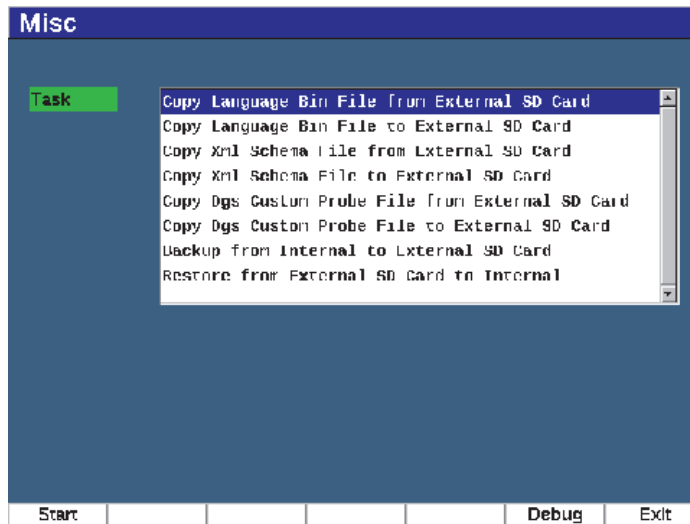


Figure 4-19 Misc setup page

---

**NOTE**

The **Debug** button (P6 key) is intended for use by an authorized Evident service center or customer service representative only.

---

#### 4.8.10 Editable Parameters Page

The Editable Parameters page allows you to customize preset values for direct access keys or coarse adjustment lists (see Figure 4-20 on page 115).

When using the dB (gain), RANGE, or DELAY direct access keys, a set of preset values appears over the parameter keys at the bottom of the screen. These values are set in the Gain, Range, and Delay rows in the Editable Parameters setup page. See “Direct-Access Parameters” on page 88 for information on the dB, RANGE, or DELAY parameter keys.

Values in the Editable Parameters setup page are also used when making coarse adjustments with the navigation pad or adjustment knob to the following parameters:

- Pulser **Frequency**
- Trigger **Angle**
- Basic **Velocity**
- Trigger **Thickness**
- Trigger **X value**

See “Parameter Adjustment” on page 64 for information on using the navigation pad or adjustment knob.

The Editable Parameters setup page displays all the system parameters that can be edited. The page layout is similar to a spreadsheet. The data is laid out in rows and columns.

Editable Parameters							
Units	<input type="text" value="in"/>						
Gain Step dB	Coarse	<input type="text" value="6.0"/>	Fine	<input type="text" value="0.1"/>			
Gain dB	<input type="text" value="10.0"/>	<input type="text" value="20.0"/>	<input type="text" value="30.0"/>	<input type="text" value="40.0"/>	<input type="text" value="50.0"/>	<input type="text" value="60.0"/>	<input type="text" value="70.0"/>
Range	<input type="text" value="0.500"/>	<input type="text" value="1.000"/>	<input type="text" value="2.000"/>	<input type="text" value="5.000"/>	<input type="text" value="10.000"/>	<input type="text" value="50.000"/>	<input type="text" value="100.00"/>
Delay	<input type="text" value="0.000"/>	<input type="text" value="-1.000"/>	<input type="text" value="1.000"/>	<input type="text" value="2.000"/>	<input type="text" value="5.000"/>	<input type="text" value="10.000"/>	<input type="text" value="20.000"/>
Freq MHz	<input type="text" value="1.0"/>	<input type="text" value="2.0"/>	<input type="text" value="2.3"/>	<input type="text" value="4.0"/>	<input type="text" value="5.0"/>	<input type="text" value="10.0"/>	<input type="text" value="20.0"/>
Angle Degree	<input type="text" value="0.0"/>	<input type="text" value="45.0"/>	<input type="text" value="60.0"/>	<input type="text" value="70.0"/>	<input type="text" value="--"/>	<input type="text" value="--"/>	<input type="text" value="--"/>
Velocity	<input type="text" value="0.0590"/>	<input type="text" value="0.1230"/>	<input type="text" value="0.1280"/>	<input type="text" value="0.2320"/>	<input type="text" value="0.2490"/>	<input type="text" value="--"/>	<input type="text" value="--"/>
Thick	<input type="text" value="0.000"/>	<input type="text" value="0.100"/>	<input type="text" value="0.250"/>	<input type="text" value="0.375"/>	<input type="text" value="0.500"/>	<input type="text" value="0.750"/>	<input type="text" value="1.000"/>
X Value	<input type="text" value="0.000"/>	<input type="text" value="0.100"/>	<input type="text" value="0.200"/>	<input type="text" value="0.300"/>	<input type="text" value="0.400"/>	<input type="text" value="0.500"/>	<input type="text" value="0.600"/>

Figure 4-20 Editable Parameters setup page

### To edit parameters

1. Choose **Inst Setup** (group 3/5).
2. Press **Edit Parameters** (P6 key).
3. Press NEXT to move across the rows to highlight the parameter you want to change.

4. Use the adjustment knob or arrow keys to change the value of the selected parameter value.
5. To erase the value of a selected parameter, press Clear (P1 key).

### **4.8.11 Analog Output Setup Page**

The analog output setup parameters are located in the **A-Out** setup page. See “Analog Output” on page 151.

---

## 5. Adjusting the Pulser/Receiver

---

This chapter describes how to adjust the EPOCH 650 ultrasonic flaw detector pulser/receiver.

### 5.1 Adjusting the System Sensitivity (Gain)

#### To adjust the system sensitivity

1. Press dB.
2. Adjust the system sensitivity (gain) in either coarse or fine increments.

---

<b>NOTE</b>
-------------

The total system sensitivity is 110 dB.

---

### 5.2 Using the AUTO XX% Feature

The AUTO XX% feature was formerly known as the AUTO-80 % in the EPOCH 4 Series. The default setting for AUTO XX% in the EPOCH 650 ultrasonic flaw detector is 80 % full-screen height (FSH). You can adjust the FSH target value to meet the demands of the application.

The AUTO XX% feature is used to quickly adjust the instrument gain (dB) setting to bring the gated peak echo to XX% FSH. AUTO XX% is especially useful for bringing the echo from a reference indication to XX% FSH to establish the instrument's reference gain level (see "Setting Reference Gain and Scanning Gain" on page 118 for further information).

You can use the AUTO XX% feature to bring an echo to XX% FSH in any gate.

### To use AUTO XX% feature

1. Press GATES to select the gate that measures the echo to be adjusted.
2. Press 2<sup>ND</sup> F, (AUTO XX%) to activate the AUTO XX% feature.

---

<b>NOTE</b>
-------------

AUTO XX% can be activated at any time during operation. If you do not actively select a gate, AUTO XX% is applied to Gate 1.

---

## 5.3 Setting Reference Gain and Scanning Gain

Establishing the current system gain as the reference (base) level is useful for inspections that require adding or subtracting scanning gain based on the relation to a fixed gain level.

### To set reference gain and adjust

1. Press 2<sup>ND</sup> F, (REF dB).  
The gain display reads: **REF XX.X + 0.0 dB**. Scanning gain can now be added or subtracted.
2. Adjust the scanning gain in either coarse or fine increments.

While using the reference gain and scanning gain, the following parameters appear at the bottom of the screen.

- **Add**  
Used to add the current scanning gain to the current reference gain for “transfer correction.”
- **Scan Db**  
Used to toggle the scanning gain from the active level to 0.0 dB (reference level) allowing a direct amplitude comparison to the reference indication.
- **Off**  
Used to exit the reference gain function without adding the scanning gain to the base instrument gain.

- **+6 dB**  
Used to add 6 dB to the reference gain. You add 6 dB each time you press this button.
- **-6 dB**  
Used to subtract 6 dB from the reference gain. You subtract 6 dB each time you press this button.

## 5.4 Pulser Adjustments

The pulser settings in the EPOCH 650 ultrasonic flaw detector are accessible from the **Pulser** menu item. The pulser setup parameters are:

- Pulse Repetition Frequency (PRF)
- Pulse Energy (Voltage)
- Damping
- Test Mode
- Pulser Type
- Pulser Frequency Selection (Pulse Width)

### 5.4.1 Pulse Repetition Frequency (PRF)

Pulse repetition frequency (PRF) is a measure of how often the transducer is being pulsed by the electronic circuitry in the EPOCH 650 ultrasonic flaw detector.

PRF is typically adjusted based on the test method or test piece geometry. For parts with long sound paths, it is necessary to lower the PRF to avoid wrap-around interference that results in spurious signals on the display. For applications with rapid scanning, it is often necessary to use a high PRF rate to assure that small defects are detected as the probe moves along the part.

The EPOCH 650 allows you to manually adjust the PRF from 10 Hz to 2000 Hz in 50 Hz (coarse) or 10 Hz (fine) increments. The instrument also has two **Auto-PRF** settings to automatically adjust the PRF based on screen range.

#### To select a PRF adjustment method

- ◆ Select **Pulser > PRF Mode**, and then vary the setting. The available choices are:

### **Auto**

Used to automatically set the PRF value based on the chosen screen range.

### **Manual**

Used to manually set the PRF value.

## **To adjust the PRF value in Manual PRF Mode**

1. Select **Pulser > PRF Mode = Manual**.
2. Select **PRF**, and then adjust the PRF in either coarse or fine increments.

---

<b>NOTE</b>
-------------

The EPOCH 650 is a *single-shot* instrument. This means that the instrument acquires, measures, and draws the complete A-scan with each pulse rather than using multiple acquisitions to construct a full waveform. The measurement rate in the EPOCH 650 is always equal to the PRF rate unless you are using a multiplexer.

---

## **5.4.2 Pulse Energy (Voltage)**

The EPOCH 650 ultrasonic flaw detector can adjust the pulse energy from 0 V to 400 V in increments of 100 V. With this flexibility, you can set the pulse energy from to a minimum when you want to extend the battery life, or provide a very high power pulser for the most difficult materials.

### **To adjust the pulser energy**

- ◆ Choose **Pulser > Energy**, and then vary the value. In the **Energy** adjustment, coarse and fine steps are equal (100 V).

---

<b>NOTE</b>
-------------

To maximize instrument battery life and transducer life, it is recommended that you use lower energy settings when the application permits. For most applications, the energy setting does not need to exceed 200 V.

---



### 5.4.3 Damping

The damping control allows you to optimize the waveform shape for high resolution measurements using an internal resistive circuit. There are four damping settings on the EPOCH 650 ultrasonic flaw detector: **50  $\Omega$** , **100  $\Omega$** , **200  $\Omega$** , or **400  $\Omega$** .

#### To adjust the Damping

- ◆ Choose **Pulser > Damp**, and then vary the setting.

---

<b>TIP</b>
------------

Generally, the lowest resistance ( $\Omega$ ) setting increases the system damping and improves near-surface resolution, while the highest resistance setting decreases system damping and improves the instrument penetration power.

---

Selecting the correct damping setting fine-tunes the EPOCH 650 in order to operate with a particular transducer selection. Depending on the transducer being used, the various damping settings either improve near-surface resolution or improve the instrument's penetration power.

### 5.4.4 Test Mode

The EPOCH 650 ultrasonic flaw detector can operate in three test modes that you can select using the **Pulser > Mode** parameter:

- **P/E**  
Used to select pulse-echo mode, where a single element transducer sends and receives the ultrasonic signal. Use either transducer connector.
- **Dual**  
Used to select pitch-and-catch mode, where a dual-element transducer has one element that transmits the ultrasonic signal and another element that receives the signal. Use the T/R labeled transducer connection as the transmit connector.
- **Thru**  
Used to select the through transmission mode, where two separate transducers are typically located on opposite sides of the test specimen. One transducer transmits the ultrasonic signal, the other receives. Use the T/R labeled transducer connection as the transmit connector.

---

<b>NOTE</b>
-------------

To compensate for the one-way sound path in through transmission (**Thru**) mode, the EPOCH 650 does not divide transit time by two when calculating thickness measurements.

---

### To adjust the test mode

- ◆ Choose **Pulser > Mode**, and then vary the setting.

## 5.4.5 Pulser Type

The EPOCH 650 operates in two pulser modes that you can select using the **Pulser** parameter of the **Pulser** mode:

### Spike

Used to mimic a traditional spike pulse by using a narrow-width pulse to excite the transducer.

### Square

Used to tune the width of the pulse to optimize the response of the transducer.

---

<b>NOTE</b>
-------------

The EPOCH 650 uses the PerfectSquare technology to achieve optimum response from the tunable square wave pulser. This PerfectSquare technology maximizes the energy used to drive the connected transducer while providing excellent near-surface resolution.

---

### To adjust the pulser waveform

- ◆ Select **Pulser > Pulser**, and then vary the setting.

---

## 5.4.6 Pulser Frequency Selection (Pulse Width)

The pulser frequency selection sets the pulse width when **Pulser > Pulser = Square**. This frequency selection allows you to tune the shape and duration of each pulse to obtain the best performance from the transducer being used. In general, the best performance is achieved by tuning the pulser frequency as close as possible to the center frequency of the transducer being used.

### To adjust the pulser frequency

- ◆ Choose **Pulser > Freq**, and then vary the setting.

---

<b>NOTE</b>
-------------

Actual results could vary due to the test material and/or variation in the transducer center frequency. Try various settings with a transducer and test piece to maximize ultrasonic performance.

---

## 5.5 Receiver Adjustments

The receiver settings are accessed from the **Rcvr** menu. The receiver parameters are:

- Digital Receiver Filters
- Waveform Rectification

### 5.5.1 Digital Receiver Filters

The has a total instrument bandwidth of 0.2–26.5 MHz at –3 dB. The instrument offers 30 standard fixed digital filters. These are designed to improve the instrument's signal-to-noise ratio by filtering out unwanted high and/or low frequency noise outside of the test frequency spectrum. The **Standard** filter set also allows the instrument to provide the dynamic range (dB) required by ISO 22232-1:2020.

In most cases, you should select either a broadband filter or a narrow-band filter that covers the frequency of the transducer being used. Due to the shifting of frequency spectrum in most materials, it might be necessary to adjust the filter settings to maximize instrument performance. Every material is different, and you must optimize the receiver settings based on the application.

The EPOCH 650 ultrasonic flaw detector contains the following seven (7) standard filters compliant with ISO 22232-1:2020.

- 2.0 MHz–21.5 MHz
- 0.2 MHz–10.0 MHz
- 0.2 MHz–1.2 MHz
- 0.5 MHz–4.0 MHz
- 1.5 MHz–8.5 MHz
- 5.0 MHz–15.0 MHz
- 8.0 MHz–26.5 MHz

The EPOCH 650 contains the following 23 Advanced filters which are not tested in accordance with ISO 22232-1:2020 (see Table 12 on page 124).

**Table 12 Advanced filters**

DC–10 MHz	DC–1.2 MHz	DC–4.0 MHz
DC–8.5 MHz	DC–15.0 MHz	DC–26.5 MHz
0.2 MHz–4.0 MHz	0.2 MHz–8.5 MHz	0.2 MHz–15.0 MHz
0.2 MHz–26.5 MHz	0.5 MHz–8.5 MHz	0.5 MHz–10.0 MHz
0.5 MHz–15.0 MHz	0.5 MHz–26.5 MHz	1.0 MHz –3.5 MHz
1.5 MHz–10.0 MHz	1.5 MHz–15.0 MHz	1.5 MHz–26.5 MHz
2.5 MHz–7.0 MHz	5.0 MHz–10.0 MHz	5.0 MHz –26.5 MHz
6.0 MHz–12.0 MHz	8.0 MHz–15.0 MHz	

### To select either the Standard or Advanced filter sets

1. Choose **Instr Setup > General** (group 3/5).
2. Press **NEXT** to select **Filter Group**.
3. Select **Standard** or **Advanced**.

### To adjust the Filter

- ◆ Choose **Rcvr > Filter**, and then vary the filter setting.

## 5.5.2 Waveform Rectification

The EPOCH 650 ultrasonic flaw detector can operate in one of four different rectification modes that you can select using the **Rcvr > Rect** parameter: **Full**, **Half+**, **Half-**, or **RF** (unrectified).

---

<b>NOTE</b>
-------------

The **RF** mode is not active while operating in special software feature modes, such as **DAC** mode or **Peak Memory**.

---

### To adjust the Rectification

- ◆ Choose **Rcvr > Rect**, and then change the rectification setting.



---

## 6. Managing Special Waveform Functions

---

This chapter describes how to manage special waveform functions of the EPOCH 650 ultrasonic flaw detector.

### 6.1 Reject

The **Rcvr > Reject** parameter allows you to eliminate unwanted, low-level signals from the display. The reject function is linear and adjustable from 0 % to 80 % FSH. Increasing the reject level does not affect the amplitude of the signals above the reject level.

---

<b>NOTE</b>
-------------

The reject function can also be used in the unrectified **Rcvr > Rect = RF** mode.

---

The reject level is displayed as an horizontal line on the instrument display (see Figure 6-1 on page 128) or two lines in the case of the unrectified **Rcvr > Rect = RF** mode.

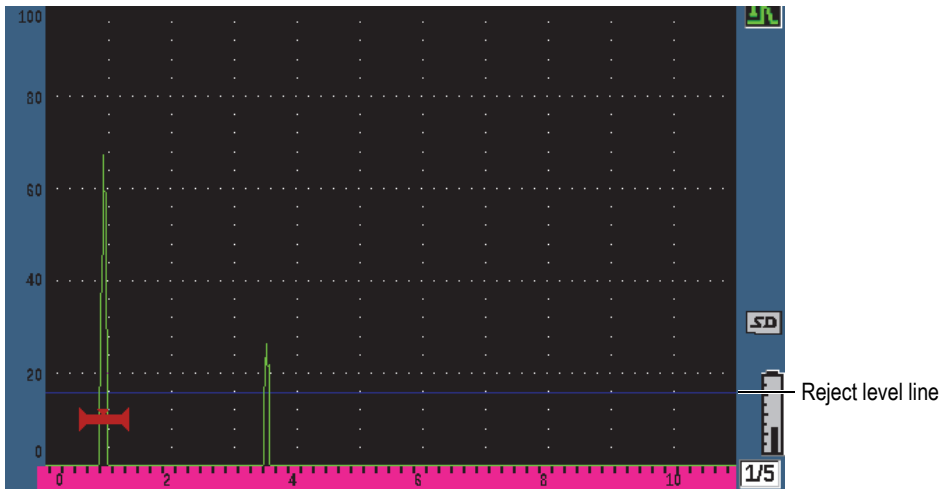
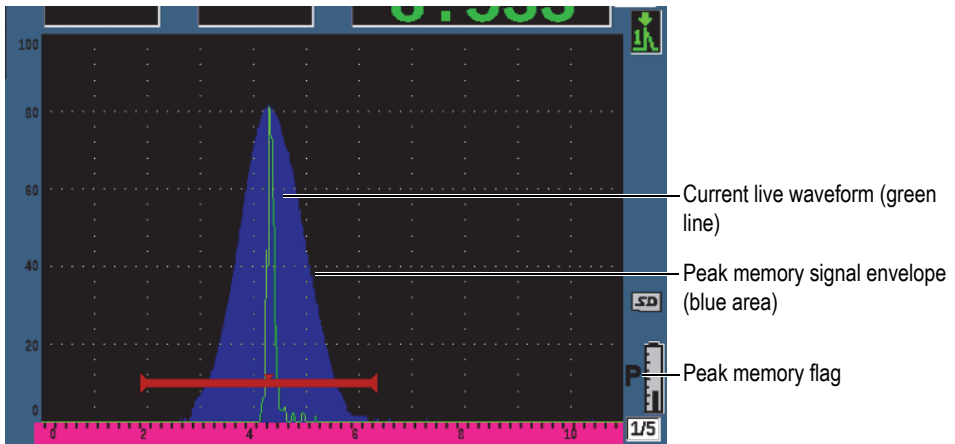


Figure 6-1 Horizontal line indicating the reject level

## 6.2 Peak Memory

The peak memory function enables the display to capture and store on the screen the amplitude of each A-scan acquisition. The display updates each pixel if a signal of greater amplitude is acquired. When you scan the transducer over a reflector, the signal envelope (echo dynamic as a function of transducer position) is held on the screen as a green line (see Figure 6-2 on page 129). In addition, the current, live waveform is displayed at the appropriate place within the signal envelope.





**Figure 6-2 Peak memory signal envelope example**

This function is useful when it is necessary to find the peak from an indication during an angle beam inspection.

#### NOTE

The peak memory function cannot be activated in the unrectified **Rcvr > Rect = RF** mode.

#### To activate peak memory function

1. Press PEAK MEM.  
The **P** symbol appears in the flag area to indicate that the function is active.
2. Scan over a reflector to acquire the echo envelope.
3. Press PEAK MEM again to turn off the peak memory function.


## 6.3 Peak Hold

The peak hold function is similar to peak memory as it captures the current screen when the function is accessed. The difference is that with peak hold, the captured waveform is frozen on the screen and does not update even if the live waveform exceeds the frozen waveform's amplitude.

Peak hold is useful when you want to obtain a waveform from a known sample and compare it to a waveform from an unknown test piece. Similarities and/or differences in the waveforms can be noted to help determine the acceptance criteria for the unknown material.


### To activate peak hold

1. Obtain an echo on the screen.
2. Press 2<sup>ND</sup> F, (PEAK HOLD).

This captures the screen and still allows viewing of the live waveform. The  symbol appears on the right side of the A-scan display indicating that the function is active.

3. Press 2<sup>ND</sup> F, (PEAK HOLD) again to shut off the peak hold function.

## 6.4 Freeze

The freeze function holds, or freezes, the information on the screen at the moment at the moment it is activated. Once the freeze function is activated, the pulser/receiver of the EPOCH 650 ultrasonic flaw detector becomes inactive and does not acquire any further data. A freeze () symbol appears on the right side of the screen indicating that the function is active.

There are two ways to activate the freeze function: manual and automatic. Manual freeze requires you to press the FREEZE key to activate the function. Automatic freeze (Auto-Freeze) allows you to automatically activate the freeze function based on any triggered gate alarm.

### To activate the freeze function manually

- ◆ Press FREEZE.

## To activate the freeze function automatically

1. Enable at least one gate alarm function (see “Gate Alarms” on page 145)
2. In the gate menu, set **AFREEZE = On**

## To deactivate the freeze function

- ◆ Press FREEZE to deactivate a manual or automatic freeze.

The freeze function is useful when storing waveforms because it holds the current A-scan. This allows the transducer to be removed from the test piece. Once the display is frozen, you can use a variety of instrument functions. These include:

- Gate movement  
To position the gate(s) over area(s) of interest to obtain measurement data.
- Gain  
To amplify signals of interest or to reduce the amplitude of signals when high-scanning gain values are being used.
- Range and delay  
To manipulate the time base to focus on the area of interest. The total instrument range cannot be increased, but can be decreased to “zoom in” on a certain area of the frozen waveform.
- Rectification  
To adjust the rectification view of the frozen waveform
- Data logging
- Printing

When the freeze function is active, the following parameters cannot be changed/accessed:

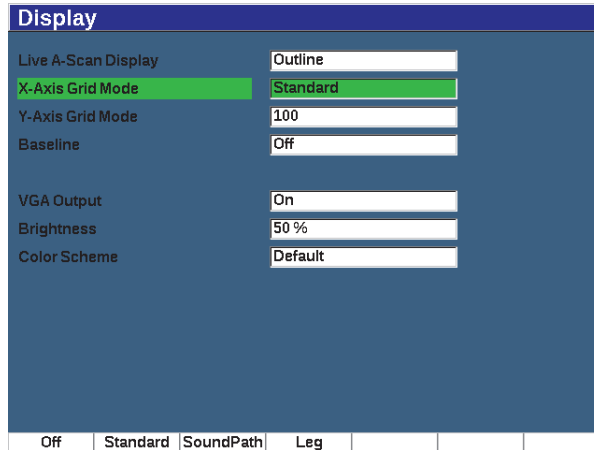
- Zero offset
- Range (cannot be increased)
- Pulser/Receiver settings such as **PRF**, **Energy**, **Mode**, pulser waveform, and **Filter**

## 6.5 Grid Modes

The EPOCH 650 ultrasonic flaw detector provides multiple grid modes for easy A-scan interpretation, depending on the application.

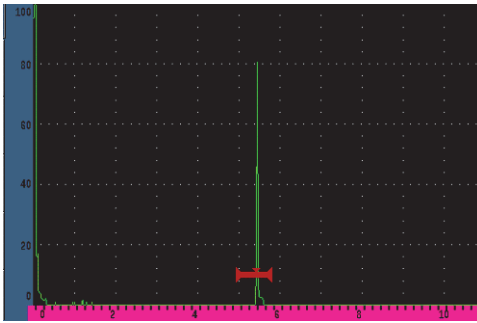
## To adjust the grid modes

1. Select **Display Setup > Display Setup** to open the **Display** setup menu.
2. Press NEXT to move the focus to the **X-Axis Grid Mode** parameter (see Figure 6-3 on page 132).

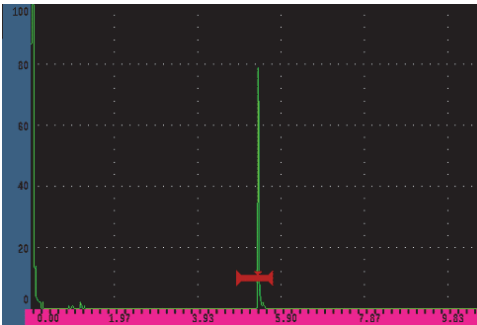


**Figure 6-3 Selecting the x-axis grid mode**

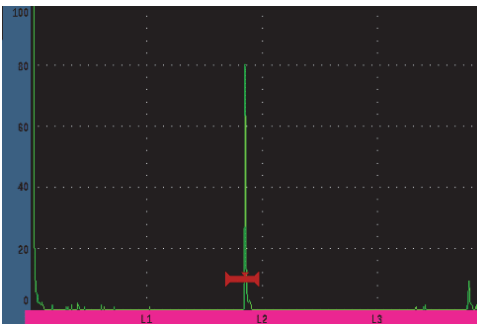
3. Use the adjustment knob or keypad to select the desired x-axis grid mode (see Figure 6-4 on page 133).



**Standard grid:** traditional flaw detector view with 10 divisions equally spaced across the screen range, and the numbers 1–10 appearing below each division.



**Sound Path grid:** displaying actual sound path measurements at equally spaced increments along the horizontal axis. This mode displays 5 divisions, each labeled with its corresponding sound path value (depending on the **Basic > Range**, **Basic > Delay**, and **Meas Setup > Units** settings).



**Leg grid:** displaying vertical lines representing angle beam inspection legs. This mode displays up to 4 divisions, labeled **L1** to **L4**, which represent each half-skip distance of a test piece during an angle beam inspection. The spacing and number of divisions displayed depends on the **Basic > Range**, **Basic > Delay**, and **Trig > Thick** (material thickness) parameters.

**Figure 6-4** The x-axis grid modes

4. Move the focus to the **Y-Axis grid Mode** parameter.
5. Select the desired y-axis grid mode (see Figure 6-5 on page 134).

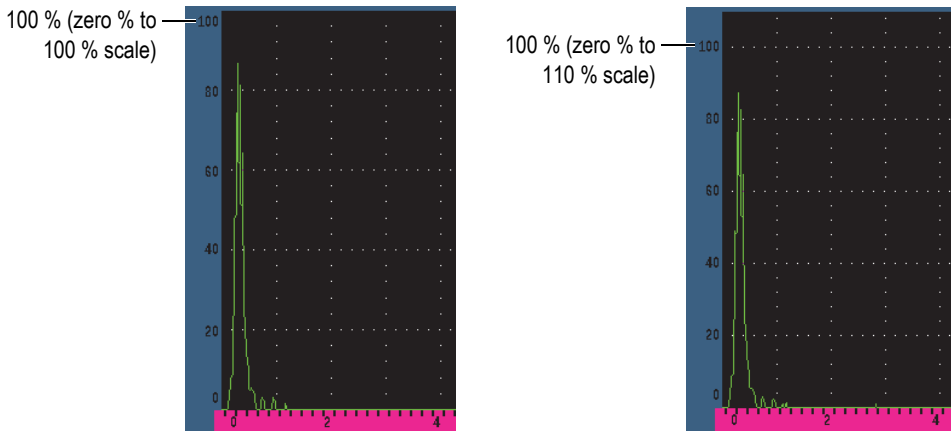


Figure 6-5 The y-axis grid modes: 100 % (left), 110 % (right)

## 6.6 Baseline Break

The baseline break feature modifies the appearance of the A-scan in full wave rectified mode. When Baseline Break is active, the instrument identifies all “zero cross” points as lines connecting individual A-scan lobes to the baseline on the display. This feature can help to visually separate far surface defect echoes from the back surface echo.

### To activate the Baseline Break function

1. Choose **Display Setup > Display Setup**.
2. Set **Baseline Break** to **On**.

---

## 7. Gates

---

This chapter describes how to use the gates of the EPOCH 650 ultrasonic flaw detector.

### 7.1 Measurement Gates 1 and 2

The EPOCH 650 ultrasonic flaw detector has two independent flaw gates. In the A-scan, a gate is represented by an horizontal line with fixed start and end points. The length and horizontal position of the line identifies the sound path range, while the vertical position of the gate line represents a threshold amplitude level for echoes of interest. In the EPOCH 650, gate 1 appears as a solid red line while gate 2 appears as a hollow blue line.

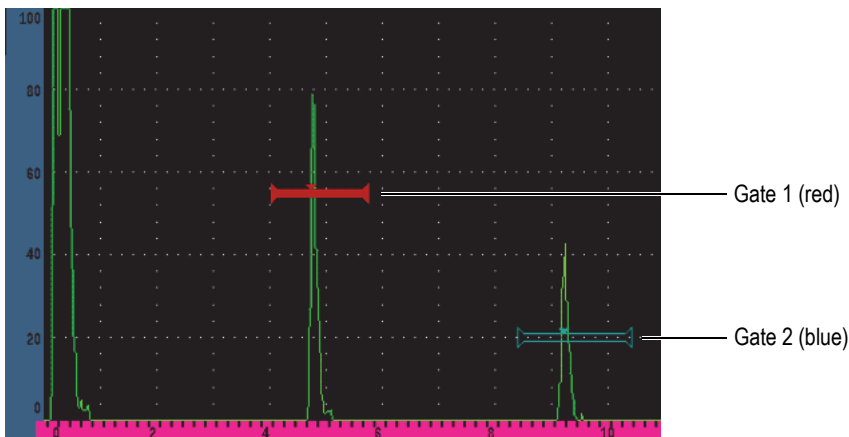


Figure 7-1 Gate 1 and gate 2 (with echo-to-echo turned on)

Both gates can be used to take thickness measurements with straight-beam transducers, sound path and depth measurements with angle beam transducers, measure signal amplitude, measure time-of-flight in microseconds, or to trigger threshold and minimum-depth alarms. The gates can also be used together to take echo-to-echo thickness measurements.

You can control the gates using the parameters in the **Gate 1** and **Gate 2** menus (see Figure 7-2 on page 136).

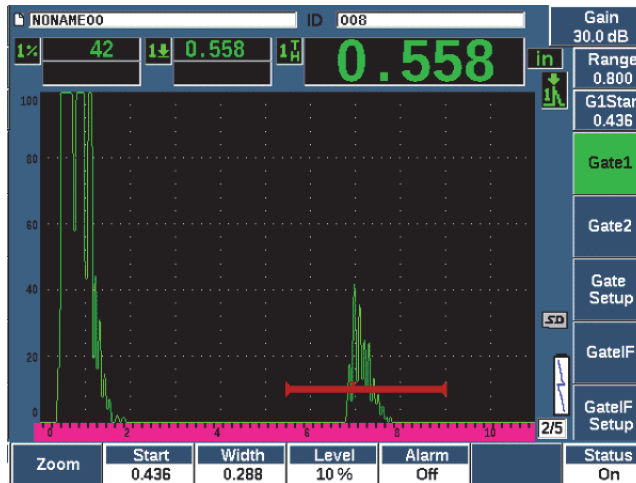


Figure 7-2 The Gate 1 menu

The available gate parameters are:

### Zoom

Used to zoom the display on the width of the gate (see “Zooming on a Gate” on page 144 for details).

### Start

Used to adjust the gate start position.

### Width

Used to adjust the gate width.

### Level

Used to adjust the vertical position of the gate.



**Alarm**

Used to select a gate alarm condition (see “Gate Alarms” on page 145 for details).

**AFreeze**

Visible only when Alarm is Positive or Negative. Activates or deactivates the Auto Freeze function (for more information, see “Freeze” on page 130).

**Min Depth**

Used to adjust the minimum depth value which triggers a minimum depth alarm. This parameter will only be available if **Alarm = MinDepth**.

**Status**

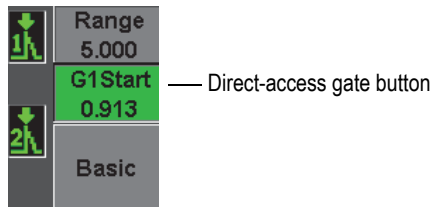
Used to toggle the state (**On** and **Off**) of the gate.

## 7.2 Quickly Adjusting Basic Gate Parameters

You can perform basic gate adjustments using the GATES direct-access key.

### To quickly adjust the position of a gate

1. Press the GATES direct-access key.  
The focus moves to direct-access gate parameter box on the right side of the main display. The gate parameter box shows the first available gate parameter (see Figure 7-3 on page 137).



**Figure 7-3 The direct-access gate parameter box**

2. Edit the value using coarse or fine increments.
3. To select a different parameter for the selected gate, or a parameter in another active gate, press the GATES key until the desired parameter is selected.

Successive presses of the GATES key will scroll through the following parameters: **G1Start**, **GIWidth**, **G1Level**, **G2Start**, **G2Width**, and **G2Level**.

---


**NOTE**

The GATES key only allows access to gates which are currently active. To activate a gate, select **Gate<n> > Status = On**.

---

4. Once the desired parameter has been selected, edit the value using coarse or fine increments. When needed, toggle between the coarse and fine adjustment mode.
- 

**NOTE**

When adjusting a gate using the direct-access GATES key, the parameter key menu along the bottom of the screen disappears, and Gates becomes the active parameter. To return to the previously selected submenu, press either the  or NEXT key. This allows you to make fast adjustments to the gate position and immediately return to the parameter of the previous operation.

---

## 7.3 Gate Measurement Modes

The EPOCH 650 ultrasonic flaw detector's two gates provide measurements of a gated indication based on one of four possible measurements modes. You can define the measurement mode of each gate in the **Gate Setup** menu (shown in Figure 7-4 on page 139).

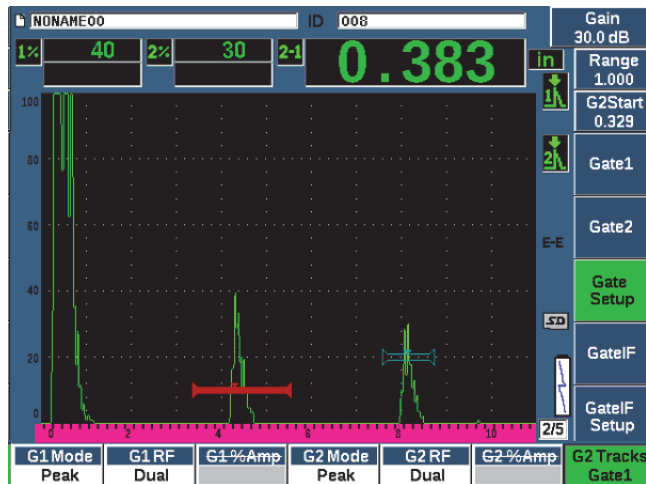


Figure 7-4 The Gate Setup menu

When a measurement is in progress using one of the measurement gates, a small triangle appears on the gate to indicate from which echo/point the measurement is being acquired (see Figure 7-5 on page 140 and Figure 7-6 on page 141). The available parameters are:

### G(1,2) Mode

Each gate can make measurements using the following modes:

#### Edge

Acquires measurement readings based on the position of the first crossing point of a gated signal. The indication must break the threshold of the gate for a measurement to be acquired. Also known as the *flank* mode.

#### Peak

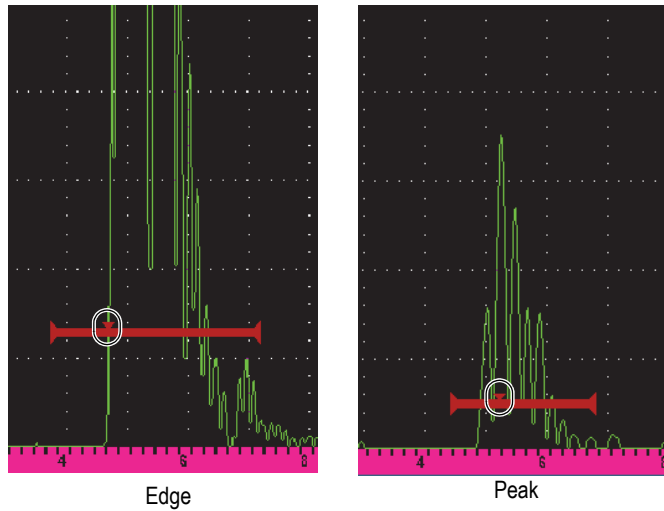
Acquires measurement readings based on the position of the highest peak within the gated screen range. The indication does not have to break the gate threshold for a measurement to be acquired.

#### 1stPeak

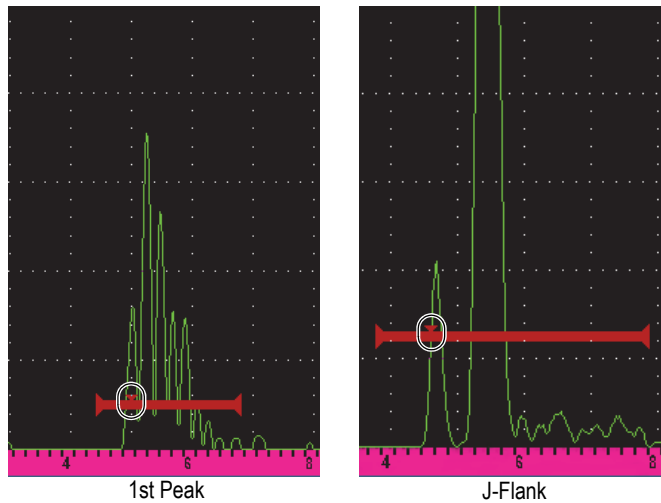
Acquires measurement readings based on the position of the first peak to break the threshold of the gate within the gated region.

## J-Flank

Acquires thickness measurement readings based on the position of the first crossing point of a gated signal and amplitude measurement readings from the highest peak of the first echo in the gated region (see Figure 7-6 on page 141)



**Figure 7-5** Trigger indicator on gate in Edge and Peak modes



**Figure 7-6 Trigger indicator on gate in 1stPeak, and J-Flank modes**

### **G(1,2) RF**

In unrectified (RF) mode, used to choose the polarity of the gate. Options include:

#### **Dual**

The gate appears in the positive and negative side of the X-axis. Position and width are identical, and the gate level mirrors across the X-axis (example: 25 % and -25 %).

#### **Positive**

The gate appears only on the positive side of the x-axis.

#### **Negative**

The gate appears only on the negative side of the x-axis.

### **G(1,2) %Amp**

In **Edge** mode only, this selection allows you to define the method for measuring amplitude of the gated indication:

#### **High Peak**

Acquires the amplitude measurement of the indication from the highest peak within the gate.

### 1stPeak

Acquires the amplitude measurement of the indication from the first peak within the gate. The peak must break the threshold of the gate to be measured. In this mode, you will now see two triangles appear on the gate. The solid triangle indicates the point from which thickness or sound path/depth measurements are being acquired. The hollow triangle indicates the point from which the amplitude measurement is being made.

---

<b>NOTE</b>
-------------

The EPOCH 650 does not acquire measurement readings unless the indication of interest is within a gated region of the screen. You should be careful to adjust the **Start**, **Width**, and **Level** of a measurement gate so that only the indication of interest falls within the gated region, per the measurement mode definitions above.

---

## 7.4 Viewing Measurement Readings

The EPOCH 650 ultrasonic flaw detector provides five measurement reading boxes to display acquired measurements. These measurement readings must be properly defined to view the desired information from a given indication.

For more information on defining measurement reading boxes, and for a full list of possible measurement readings, see “Reading Setup Page” on page 103.

## 7.5 Gate Tracking and Echo-to-Echo Measurements

The gate tracking feature of the EPOCH 650 ultrasonic flaw detector allows you to make echo-to-echo measurements whenever this feature is required by an application. Echo-to-echo measurements can be made between gate 2 — gate 1.

---

<b>NOTE</b>
-------------

Gate tracking can also be accomplished between either gate 1 or gate 2 and the optional interface gate. See “Interface Gate” on page 283 for more information.

---

Gate tracking maintains a constant separation between the position of the indication in the first gate and the start position of the second gate. With this dynamic mobility, the tracking gate is always positioned where you want to measure other indications. When gate tracking is active, the start position value of the tracking gate (the second gate involved in the measurement) defines the separation between the gates, not a fixed start position.

### To make echo-to-echo measurements with gate 1 and gate 2

1. Activate both gates by selecting **Gate 1 > Status = On** and **Gate 2 > Status = On**.
2. As shown in the example of Figure 7-7 on page 143, position gate 1 over the first echo to detect, and then position gate 2 over the second echo to detect.

The **Gate 2 > Start** position defines the separation between the position of the indication in gate 1 and the start of gate 2.

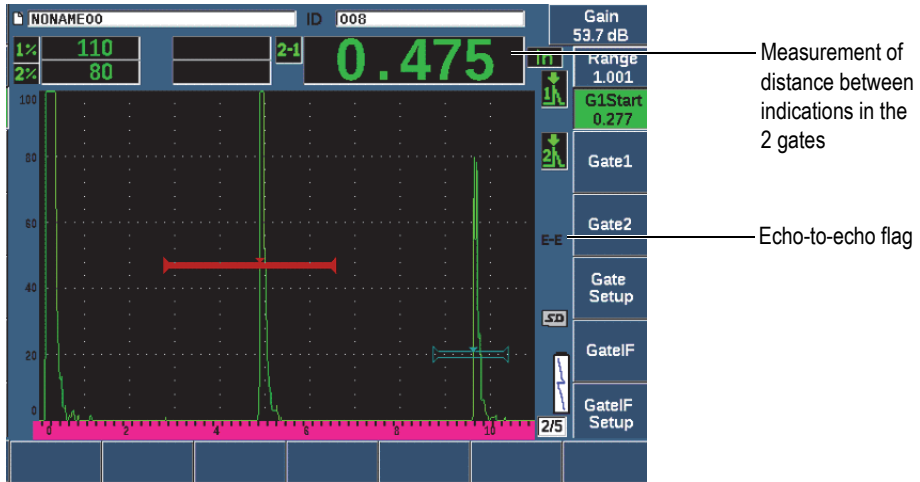


Figure 7-7 Echo-to-echo measurement example

3. Set gate 2 as the tracking gate by selecting **Gate Setup > G2 Tracks = On**.  
The echo-to-echo mode flag (**E-E**) appears on the right side of the display, indicating that the instrument is measuring the distance between positions of the indications in gate 1 and gate 2.

## 7.6 Operating in Time-of-Flight Mode

The EPOCH 650 ultrasonic flaw detector is capable of displaying time-of-flight (TOF) sound path data for a gated indication. Time-of-flight is the location of the reflector in terms of microseconds.

The time-of-flight mode does not divide the measurement reading value by two. The entire time-of-flight through the test piece in both directions is displayed.

---

<b>NOTE</b>
-------------

When the instrument is set up to display distances in time-of-flight mode, the **Basic > Velocity** parameter becomes inactive. This is because the time-of-flight mode does not use the material velocity to calculate sound path measurements.

---

### To operate in time-of-flight mode

- ◆ Select **Meas Setup > Unit =  $\mu$ s**.

In time-of-flight mode, all distance measurements are displayed in microsecond values instead of inches or millimeters.

## 7.7 Zooming on a Gate

The EPOCH 650 ultrasonic flaw detector allows you to quickly zoom the screen range to provide fine resolution of a particular inspection zone. Using zoom, the instrument automatically uses screen delay to bring the point that corresponds to the gate start to the left side of the screen and adjusts the displayed range to match the gate width. The new range equals the normal gate width. The lowest achievable value of the expanded range is equivalent to the minimum range of the instrument at the current material-velocity setting. When the zoom is active, the zoom flag (**Z**) appears on the right side of the display.

### To zoom on a gate

1. Select **Gate 1 > Status** or **Gate 2 > Status** (group 2/5).
2. Press **On** (P7 key) to activate the gate.



3. Position the gate to the desired position.
4. Press **Zoom** (P1 key) to zoom in.
5. Press **Zoom** again to zoom out (default view).

---

<b>NOTE</b>
-------------

Zoom can only be active for one gate at a time.

---

## 7.8 Gate Alarms

The EPOCH 650 ultrasonic flaw detector features a variety of alarm configurations for each measurement gate. In unrectified (RF) mode, these alarms can be used in positive, negative, or dual gate modes.

By default, when an alarm condition is triggered, the EPOCH 650 emits an audible beep. The instrument also illuminates the red indicator, above the display window, corresponding to the gate with which the alarm has been triggered. To toggle the audible alarm on and off, see “General Setup Page” on page 107.

The three primary types of gate alarms are positive threshold, negative threshold, and minimum depth.

When an alarm condition is triggered on a particular gate, the corresponding alarm output pin on the Digital Out connector provides a 5V TTL signal. For more information, see “Alarm Outputs” on page 149.

### 7.8.1 Threshold Alarms

Threshold alarms can be set on gate 1 or gate 2.

A positive logic alarm is triggered when a signal breaks the gate threshold. A negative logic alarm is triggered when a signal drops out of the gate threshold.

When you set a threshold alarm, the appearance of the tick marks at the end of the gate changes. For positive logic alarms, the tick marks point upward and for negative logic alarms they point downward (see Figure 7-8 on page 146). All alarm conditions are stored in the EPOCH 650 data logger when the gate alarm is active and triggered at the time of file storage. All saved IDs with an active alarm display A1 for gate 1 alarm, A2 for gate 2 alarm, or AIF for interface gate alarm.

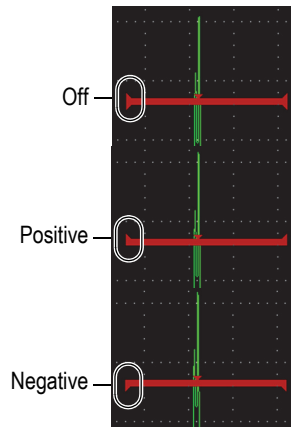


Figure 7-8 Gate tick marks indicating alarm threshold type

### To set a threshold alarm

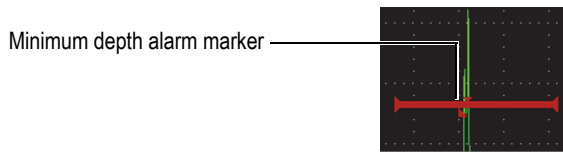
1. Activate the gate by selecting **Gate<n> > Status = On**.
2. Position the gate to cover the desired area.
3. Choose **Gate<n> > Alarm**, and then select either the **Positive** or **Negative** threshold alarm condition.

## 7.8.2 Minimum Depth Alarm

The EPOCH 650 ultrasonic flaw detector is equipped with a minimum depth alarm that is triggered whenever the current thickness measurement reading falls below an operator-defined level. The minimum depth alarm can be used either with a single gate or in echo-to-echo measurement mode.

## 7.8.3 Minimum Depth Alarm with a Single Gate

When the minimum depth alarm is activated, a marker appears on the gate to visually indicate the current setting (see Figure 7-9 on page 147). Any indication that exceeds the gate threshold to the left of the marker triggers the alarm.



**Figure 7-9 Minimum depth alarm marker**

### To set a minimum depth alarm

1. Activate the gate by selecting **Gate<n> > Status = On**.
2. Position the gate to cover the desired area.
3. Select **Gate<n> > Alarm = Min Depth**
4. Choose **Gate<n> > Min Depth**, and then adjust the desired minimum value. The minimum depth alarm value must be greater than the gate start value and less than the gate width value.

---

**NOTE**

The Minimum Depth Alarm is not available when certain special functions are enabled.

---

### 7.8.4 Minimum Depth Alarm with Gate Tracking

The EPOCH 650 ultrasonic flaw detector can use the minimum-depth alarm when making echo-to-echo thickness measurements with gate tracking. When gate tracking is active, the tracking gate moves side-to-side, tracking the position of the echo in the non-tracking (first) gate. With gate tracking active, the **Min Depth** alarm threshold is relative to the position of the echo in the non-tracking gate (first gate).

To set up a minimum depth alarm with gate tracking, follow the steps described in “Minimum Depth Alarm with a Single Gate” on page 146.



---

## 8. Programmable Inputs and Outputs

---

Some of the pins on the Digital Out connector can be programmed to accomplish certain actions. The optional Analog Out connector can be programmed to output information to an external device.

### 8.1 Alarm Outputs

The EPOCH 650 includes three dedicated alarm outputs that allow you to control an external device based on an alarm condition (see Table 21 on page 317). Each alarm output is a 5 V TTL digital signal that corresponds to the current alarm condition for each gate. The three gate alarms that can be set are positive threshold, negative threshold, and minimum depth (see “Gate Alarms” on page 145). When a gate alarm is triggered, the corresponding alarm output switches from 0 V to 5 V TTL.

### 8.2 Serial/USB Command Protocol

The EPOCH 650 can be remotely controlled through either the Digital Out connector or the USB Client port. A comprehensive series of remote commands is available to allow you access to all functions of your instrument. Contact Evident for further information.

Through serial communication over either the Digital Out connector or the USB Client port, you can connect the EPOCH 650 to a computer for communication with the optional Evident GageView Pro computer software.

## 8.3 Trigger Inputs and Outputs

The EPOCH 650 trigger synchronization capability allows the instrument to be used with other devices or instruments. The trigger governs the timing of each instrument pulse based on the chosen mode and, where applicable, external input. Trigger synchronization is supported as either a trigger input or trigger output on a combined signal through the Digital Out connector (see Table 21 on page 317). The trigger modes are as follows:

- **Internal**

This is the standard operational mode that internally controls the pulse timing and frequency. When set to the internal mode, the EPOCH 650 outputs a synchronization pulse that is identical in rate and timing to the pulse it is sending to the transducer connectors.

- **External**

This mode allows an external device to control the pulse timing and frequency of the EPOCH 650 via the RXD pin located on the Digital Out connector (see “EPOCH 650 15-pin digital port output” on page 317). When no external input pulse is present on the RXD pin, no pulse is sent to the connected transducer(s), and the EPOCH 650 appears to be nonresponsive.

- **Single**

This mode allows you to manually control the instrument pulse timing and frequency. You can also control the instrument via computer commands.

### To use the trigger input and output

1. Choose the **Meas Setup > Special** (group 3/5) menu, and select **Trigger Mode**.
2. Adjust the trigger mode to the desired setting.

When in **Single** mode, the EPOCH 650 does not send a pulse to the connected transducer(s) until the Check key (✓) is pressed (or through remote commands via the Digital Out or USB connector). If (✓) is not pressed, or no remote command is sent, the instrument appears to be nonresponsive.

---

<b>NOTE</b>
-------------

You cannot simultaneously control both a trigger input and output.

---

## 8.4 Encoder Inputs

The optional Evident B-scan encoder BSCAN-ENC (U8779522) can be connected to the EPOCH 650 Digital Out connector using the CBAS-10669-0010 (Q7790008) encoder cable. This setup provides single axis quadrature encoder inputs exclusively to the B-can feature embedded in the Corrosion Module (see “Corrosion Module” on page 287). Other encoders instead of the BSCAN-ENC can be supported using customized cables.

## 8.5 Analog Output

The EPOCH 650 ultrasonic flaw detector offers an optional programmable analog output. This analog output allows the instrument to continuously output thickness or amplitude information to an external device, such as a strip chart recorder or a computer outfitted with an analog/digital converter card.

The information is output as a scaled voltage, on either a 0–1 V or 0–10 V scale. The EPOCH 650 is connected to the external device by means of the analog output LEMO 00 connector on the top of the instrument. Each scaled voltage is output at full PRF rate up to 2 kHz.

### To access the analog output setup parameters

1. Choose **Meas Setup > A-Out** (group 3/5) to display the **A-Out** setup page (see Figure 8-1 on page 153).
2. Press NEXT to move through the form fields.
3. Use the adjustment knob or keypad to select an available parameter setting:
  - **Reading**  
Used to select the measurement type (thickness or amplitude) to output. Available settings are:
    - **Gate1 Thickness**
    - **Gate2 Thickness**
    - **Gate1 Current Amplitude**
    - **Gate2 Current Amplitude.**
  - **Output**  
Used to select the range of voltage output from the unit. Available settings are:

- **Off**
- **0–1 V**
- **0–10 V.**
- **Mapping**

Used to select the scale of the output voltage based on:

  - **Range:** The current screen range
  - **GateWidth:** The width of the selected output gate
  - **Fixed Range:** A fixed screen range independent of the current screen range.
- **Fixed Range**

Used to set the fixed screen range of the scaled output when **Mapping** is set to **Fixed Range**.
- **Load**

Used to select the value for the impedance of the peripheral device measuring the analog output of the EPOCH 650 instrument.

Matching the impedance of the output from the EPOCH 650 with the impedance of the input to the peripheral device allows the instrument to properly offset the analog output to produce predictable output voltages based on screen measurements. For example, a measurement of 10 mm (.393 in.) on a 100 mm (3.93 in.) screen range, with an analog output range of 0–10 V, should produce an analog output of 1 V. Without impedance matching, the value can be skewed above or below the expected 1 V output value (0.95 V or 1.02 V, etc).



A-Out	
Reading	Gate2 Current Amplitude
Output	Off
Mapping	Range
Fixed Range	0.000
Load	1000 K $\Omega$

Figure 8-1 The A-Out setup page



---

## 9. Calibration

---

Calibrating the EPOCH 650 ultrasonic flaw detector is the process of adjusting the unit so that it measures accurately on a particular material, using a particular transducer at a particular temperature.

In calibrating the instrument, you set the zero offset and velocity parameters. The zero offset (sometimes referred to as probe delay) is set to compensate for the dead time between the firing of the main pulse and the entry of the sound into the test piece. The velocity is set so that it matches the material velocity of the test piece.

The EPOCH 650 features advanced auto-calibration that provides for a fast and easy calibration process. This section details the procedures to calibrate the EPOCH 650 using the four basic transducer configurations: straight beam, delay line, dual element, and angle beam.

### 9.1 Basic Setup

Until you are completely comfortable operating the EPOCH 650 ultrasonic flaw detector, we recommend using a basic setup procedure before starting the actual calibration.

#### To setup the EPOCH 650 before calibrating

1. Press **dB** to select an initial gain value that is appropriate for the calibration. If the appropriate gain level is unknown, set the initial gain at 20 dB and adjust it as necessary during calibration.
2. Choose **Basic > Velocity**, (group 1/5) and then enter an approximate velocity for the test material. See “Sound Velocities” on page 319 for a table with sound velocities for various materials.

Note that the **Velocity** parameter is disabled when the instrument is in time-of-flight ( $\mu\text{s}$ ) mode. Select **Meas Setup > Unit** (group 3/5), then select **mm** or **in** to enable the **Velocity** parameter.

3. Choose **Basic > Zero**, and then adjust the zero offset of the instrument to 0.000  $\mu\text{s}$ .
4. Choose **Basic > Range**, then set the range based on the sound path range within the selected calibration block.

---

<b>TIP</b>
------------

Use more range than necessary to ensure all calibration echoes appear on the screen.

- 
5. Choose **Basic > Delay**, then set the screen delay to 0.00 mm or (0.000 in.).
  6. Choose **Trig > Angle** (group 1/5), and then enter the correct refracted angle for the probe (0 for a straight beam probe, 45 for a 45° probe, etc.).
  7. Choose **Trig > Thick**, and then set the material thickness to 0.00 mm or (0.000 in.).
  8. Choose **Rcvr > Reject** (group 1/5), and then set the reject level to 0 %.
  9. Select **Gate 1 > Status** (group 2/5), and set it to **On** to activate gate 1.
  10. Couple the transducer to the block, and then adjust the pulser and filter settings to create a clean A-scan.

For more information on pulser and receiver adjustments, see “Pulser Adjustments” on page 119 and “Receiver Adjustments” on page 123.

---

<b>TIP</b>
------------

Use the auto measurement reading selection feature so that the EPOCH 650 automatically displays relevant thickness/sound path measurements during calibration based on the instrument settings. For more information, see “Reading Setup Page” on page 103.

---

## 9.2 Calibration Modes

The EPOCH 650 ultrasonic flaw detector features multiple calibration modes to accurately meet the requirements of the selected transducer, calibration test block, and application. These calibration modes can be adjusted in the **Auto Cal** menu. There are two modes for straight beam transducers and two modes for angle beam transducers.

## 9.2.1 Straight Beam Modes

Straight beam calibrations can be performed by two methods. For the purposes of this calibration discussion, *straight beam* refers to all zero-degree probes, including contact, dual, delay line, immersion, etc. The two methods of straight beam calibration are:

- Thickness

This standard straight beam calibration mode requires you to provide two different, known material thicknesses to properly calibrate the instrument. The thin material thickness allows for zero offset calibration, and the thick material thickness allows for velocity calibration.

- Echo-to-echo

This calibration mode allows you to use any echo-to-echo measurement to calibrate for material velocity only. In echo-to-echo calibration, the effects that cause zero offset are eliminated by gating a particular indication that represents the start point of the measurement. A second gate is set to track that gated indication to acquire a measurement. This means that you must only calibrate for the material velocity of the sample to acquire accurate echo-to-echo measurements. You can perform echo-to-echo measurements between **G2–G1**, and this calibration mode will only be available if Gate 2 tracking is turned on (see “Gate Tracking and Echo-to-Echo Measurements” on page 142).

## 9.2.2 Angle Beam Modes

Angle beam calibrations can be performed by two methods:

- Sound path

This standard angle beam calibration mode uses the sound path measurement of two different, known material thicknesses to properly calibrate the instrument. Typically, these sound path measurements are made from the radius of a calibration test block. The smaller (thin) sound path measurement allows for zero offset calibration, and the larger (thick) sound path measurement allows for velocity calibration.

- Depth

This angle beam calibration mode uses the known depth of two different reflectors to properly calibrate the instrument. Typically, these depth measurements are made from side-drilled holes of equal size. For accurate measurements, you must first verify the refracted angle of the transducer, as the EPOCH 650 calculates depth values based on sound path and known refracted

angle. The shallow reflector depth allows for zero offset calibration, and the deep reflector depth allows for velocity calibration.

### 9.3 Calibrating with a Straight Beam Transducer

The sample straight beam calibration described below is performed using an Evident transducer part number A109S-RM, with a frequency of 5.0 MHz and an element diameter of 13 mm (0.50 in.).

The calibration requires a test block with two known thicknesses made from the material to be measured. Ideally, the two thicknesses should represent thicknesses that are both below and above the expected thickness of the material being inspected.

For this example, Evident standard 5-step steel test block (P/N: 2214E) is used. The steps measure 0.100 in., 0.200 in., 0.300 in., 0.400 in., and 0.500 in.

---

<b>NOTE</b>
-------------

If the EPOCH 650 is set to work in metric units, the calibration process is exactly the same, except that the entries are in millimeters rather than inches.

---

#### To calibrate using a straight-beam transducer

1. Follow the initial setup procedure outlined in “Basic Setup” on page 155.
2. Connect the transducer to an appropriate cable and then connect the cable to either of the transducer connectors at the top of the instrument.
3. Choose **Auto Cal > Type = Thickness**.
4. Couple the transducer to the thin calibration block step. For this example, the transducer is coupled to the 0.200 in. step.

---

<b>NOTE</b>
-------------

Depending on the frequency of the contact transducer being used, it might be impossible to obtain a proper reading on very thin material.

---

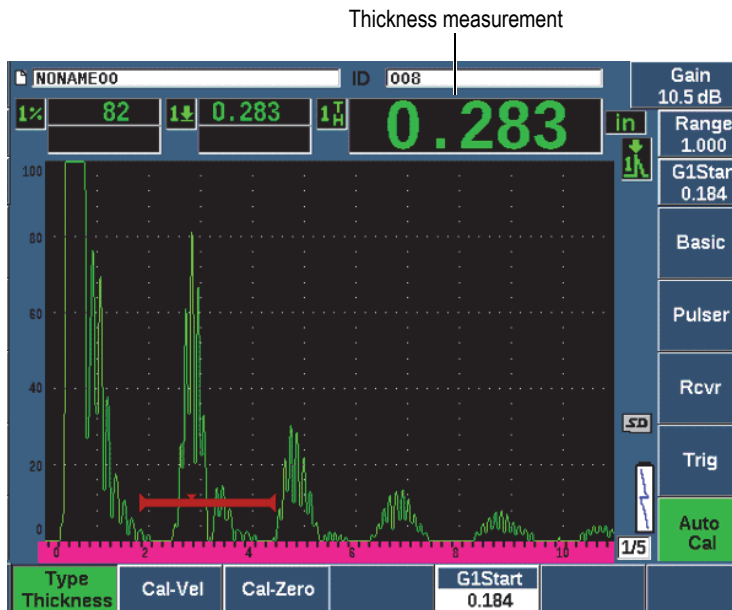
5. Use the G1Start button (P5 key) to position gate 1 so that the first back-wall echo from the known thickness step exceeds the gate threshold.

- Press dB, and then adjust the gain value so that the echo amplitude is at approximately 80 %.

### TIP

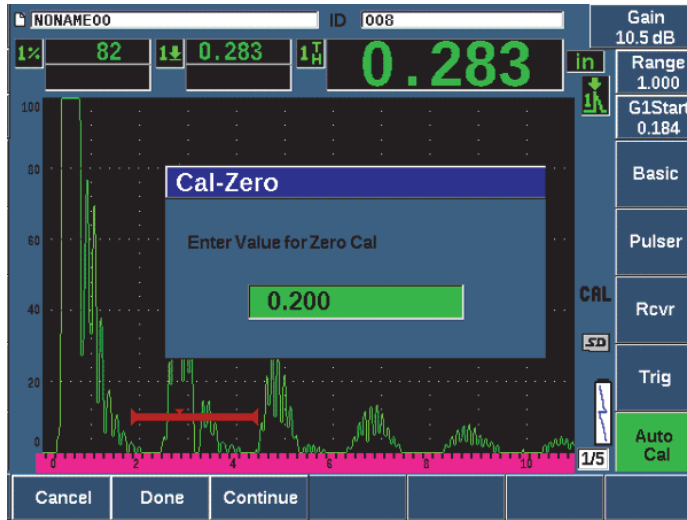
The AUTO XX% feature automatically adjusts the gain to set the gated echo amplitude to XX% of full screen height (the default XX value is 80 %). To activate this feature, press 2<sup>ND</sup> F, (AUTO XX%).

A thickness measurement reading appears in large text above the A-scan (see Figure 9-1 on page 159).



**Figure 9-1 Example of a gated signal for zero calibration**

- Once a steady reading is achieved, choose **Auto Cal > Cal-Zero**.  
The screen freezes and the **Cal-Zero** box appears (see Figure 9-2 on page 160).



**Figure 9-2 Entering the Zero Cal thickness value**

- Adjust the value to match the known thickness of the gated indication (0.200 in. in this example), and then press **Continue** (P3 key) to continue to the second calibration step (see Figure 9-3 on page 161). The thickness value used in this part of the calibration will be stored for reference in the **Cal-Zero** parameter box.

---

**NOTE**

To exit without acquiring calibration data, press **Cancel** (P1 key).

---





Figure 9-3 Example of a gated signal for velocity calibration

9. Couple the transducer to the thick calibration block step.  
In this example, the transducer is coupled to the 0.500 in. step.
10. Use the GATES key to position gate 1 so that the first back-wall echo from the known thickness step exceeds the gate threshold.
11. Press dB to adjust the gain setting so that the echo amplitude is at approximately 80 %.  
A thickness measurement reading appears in large text above the A-scan.
12. Once a steady reading is achieved, choose **Auto Cal > Cal-Vel**.  
The screen freezes and the **Enter Value for Velocity Cal** box appears (see Figure 9-4 on page 162).

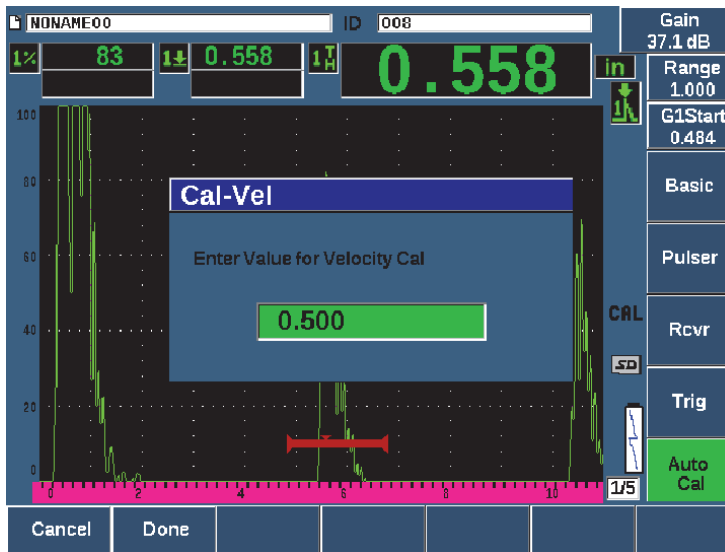


Figure 9-4 Entering the Velocity Cal thickness value

13. Adjust the value to match the known thickness of the gated indication (0.500 in. in this example), and then choose **Done** (P2 key) to complete the calibration process.

#### TIP

It is possible to auto-cal on a test block with only one known thickness. In this scenario, leave the transducer coupled on the unique thickness, move the gate over to one of the multiple back-wall echoes, and then enter the correct sound path thickness (the appropriate multiple of the first back-wall echo) during the velocity portion of the calibration.

## 9.4 Calibrating with a Delay Line Transducer

The sample delay line calibration described below is performed using Evident transducer part number V202-RM, with a frequency of 10.0 MHz and an element diameter of 6 mm (0.25 in.).

The calibration requires a test block with two known thicknesses, made from the material to be measured. Ideally, the two thickness measurements are both below and above the expected thickness of the material to be inspected. For this example, we are using Evident standard 5-step steel-test block, part number 2214E. The steps measure 0.100 in., 0.200 in., 0.300 in., 0.400 in., and 0.500 in.

---

<b>NOTE</b>
-------------

If the EPOCH 650 is set to work in metric units, the calibration process is exactly the same, except that the entries are in millimeters rather than inches.

---

### To calibrate using a delay line transducer

1. Follow the initial setup procedure outlined in “Basic Setup” on page 155.
2. Connect the transducer to an appropriate cable and then connect the cable to either of the transducer connectors at the top of the instrument.  
With a zero offset of 0.000  $\mu\text{s}$ , the excitation pulse (or main bang) should appear on the left side of the screen.
3. Choose **Basic > Zero** (group 1/5), and then increase the value until the excitation pulse moves off the left side of the screen and the interface echo from the end of the delay line tip appears on the screen.
4. Verify that the echo represents the end of the delay by tapping your finger on the end of the couplant-coated delay line. This dampens the signal and the echo should jump up and down on the screen.
5. Choose **Basic > Zero**, and then increase the value to move this echo to the left side of the screen so that it is barely visible.

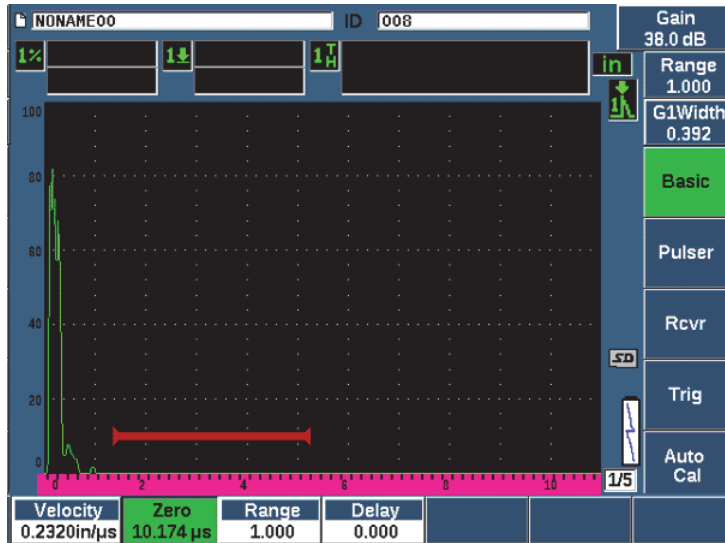


Figure 9-5 Adjusting zero offset for the first delay line echo

6. Select **Auto Cal > Type = Thickness**.
7. Couple the transducer to the thin calibration block step. For this example, the transducer is coupled to the 0.100 in. step.
8. Use the G1Start button (P5 key) to position gate 1 so that the first back-wall echo from the known thickness step exceeds the gate threshold.
9. Press dB, and then adjust the gain value so that the echo amplitude is at approximately 80 %.

#### TIP

The AUTO XX% feature automatically adjusts the gain to set the gated echo amplitude to XX% of full screen height (the default XX value is 80 %). To activate this feature, press 2<sup>ND</sup> F, (AUTO XX%).

A thickness measurement reading appears in large text above the A-scan (see Figure 9-6 on page 165).

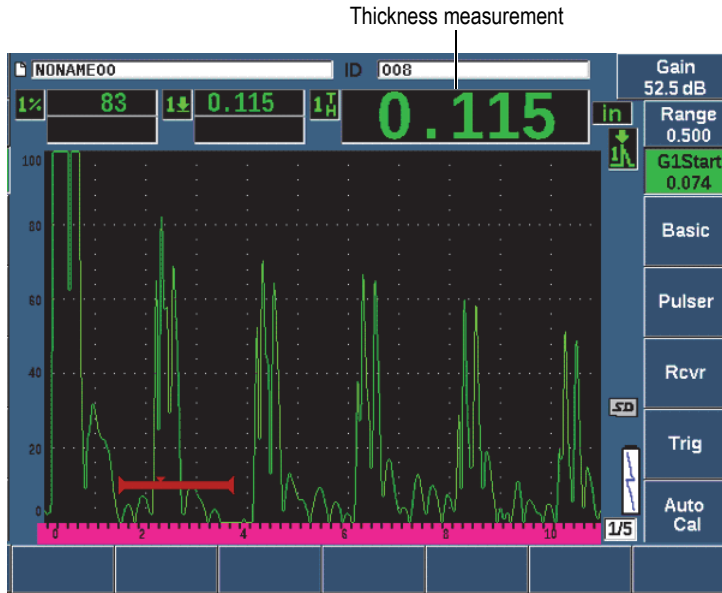


Figure 9-6 Example of a gated signal for zero calibration

**NOTE**

Ensure that it is the first back-wall echo being gated, not a multiple echo from the end of the delay line tip.

10. Once a steady reading is achieved, choose **Auto cal** > **Cal-Zero**.

The screen freezes and the **Cal-Zero** box appears (see Figure 9-2 on page 160).

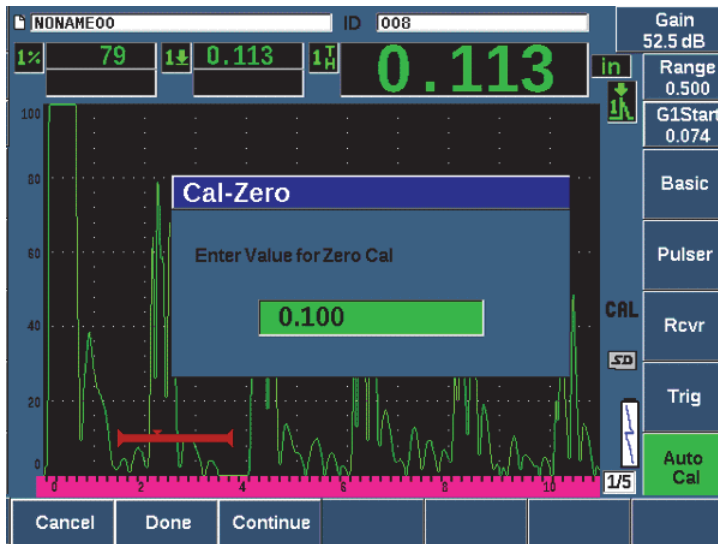


Figure 9-7 Entering the Zero Cal thickness value

11. Adjust the value to match the known thickness of the gated indication (0.100 in. in this example), and then press **Continue** (P3 key) to continue to the second calibration step (see Figure 9-8 on page 167). The thickness value used in this part of the calibration will be stored for reference in the **Cal-Zero** parameter box.

---

**NOTE**

If you need to exit without acquiring calibration data, press **Cancel** (P1 key).

---

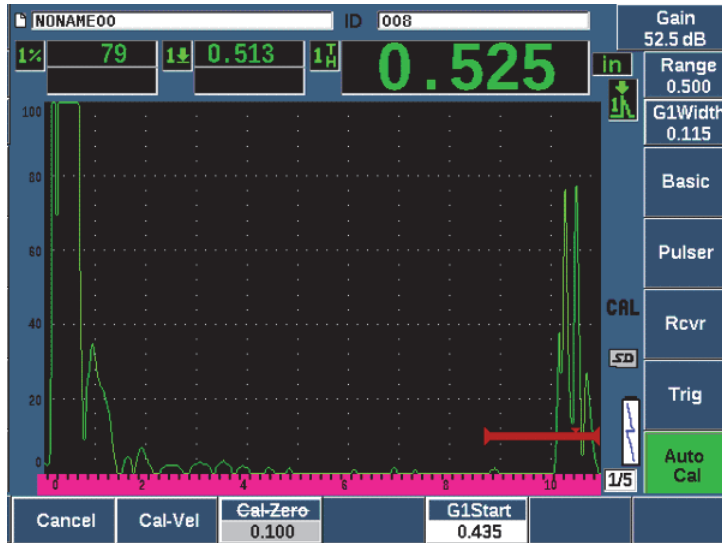


Figure 9-8 Example of a gated signal for velocity calibration

12. Couple the transducer to the thick calibration block step.  
In this example, the transducer is coupled to the 0.500 in. step.
13. Use the G1Start button (P5 key) to position gate 1 so that the first back-wall echo from the known thickness step exceeds the gate threshold.
14. Press dB, and then adjust the gain value so that the echo amplitude is at approximately 80 %.  
A thickness measurement reading appears in large text above the A-scan.
15. Once a steady reading is achieved, choose **Auto Cal** > **Cal-Vel**.  
The screen freezes and the **Cal-Vel** box appears.
16. In the **Cal-Vel** box, adjust the value to match the known thickness of the gated indication (0.500 in. in this example), and then choose **Done** to complete the calibration process (see Figure 9-9 on page 168).

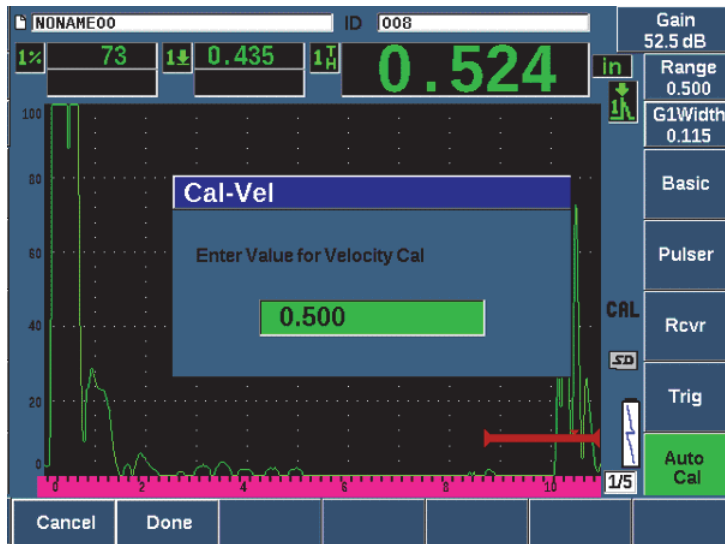


Figure 9-9 Entering the Velocity Cal thickness value

## 9.5 Calibrating on a Single Test Block of Known Thickness

You can also auto-calibrate on a single test block of known thickness. You can use multiple back-wall echoes instead of coupling on both a thin step and a thick step. In this scenario, leave the transducer coupled on the thin step, move the gate over to one of the multiple back-wall echoes, and then enter the correct sound path thickness (2, 3, 4, etc. multiple of the first back-wall echo) during the velocity portion of the calibration.

## 9.6 Calibrating with a Dual Element Transducer

The sample dual element calibration described below is performed using an Evident transducer part number DHC711-RM with a frequency of 5.0 MHz and an element diameter of 6 mm (0.25 in.).



The calibration requires a test block with two known thicknesses made from the material being measured. Ideally, the two thicknesses should represent thicknesses that are both below and above the expected thickness of the material to be inspected. For this example, Evident standard 5-step steel test block (part number 2214E) is used. It has steps measuring 0.100 in., 0.200 in., 0.300 in., 0.400 in., and 0.500 in.

---

<b>NOTE</b>
-------------

If the EPOCH 650 is set to work in metric units, the calibration process is exactly the same, except that the entries are in millimeters rather than inches.

---

Because of the acoustic characteristics of dual transducers, nonlinearity in the distance calibration occurs as the thickness of the material decreases. The point of maximum sensitivity is determined by the roof angle of the particular dual transducer. The distance calibration should be performed using a step block that covers the range of interest. Be careful when interpreting thickness measurement readings made outside of the calibrated range. The EPOCH 650 does not have v-path correction; possibly causing some nonlinearity within the calibrated range. The amount of nonlinearity depends on the minimum thickness used in the calibration process.

The zero offset value of dual element transducers can vary significantly at extreme temperatures. If the temperature changes more than a few degrees from the temperature at which the zero offset value was established, recheck its value. If you intend to make thickness measurements over a wide temperature range, you should use Evident D790-SM and D791 dual element transducers. These transducers are designed for high-temperature applications and have built-in delay lines with a stable sound velocity that does not change significantly with temperature.

### To calibrate using a dual element transducer

1. Follow the initial setup procedure outlined in “Basic Setup” on page 155.
2. Connect the transducer to an appropriate cable, and then connect the cable to the transducer connectors at the top of the instrument.
3. Select **Pulser > Mode = Dual**.
4. Press dB, and then increase the gain significantly so that the leading edges of the back-wall echoes appear as nearly vertical lines on the screen.
5. To use the leading edge when making thickness measurements, set the measurement gate to the edge detection mode by selecting **Gate Setup > G1 Mode = Edge**.

6. Select **Auto Cal > Type = Thickness**.
7. Couple the transducer to the thin calibration block step.  
For this example, the transducer is coupled to the 0.100 in. step. As noted above, a higher gain setting is required to produce a clean leading edge of the signal. Do not be concerned with the jagged peaks of the echo. Concentrate on the leading edge only.
8. Use the G1Start button (P5 key) to position gate 1 so that the leading edge of the first back-wall echo from the known thickness step exceeds the gate threshold.
9. Press dB and adjust the gain setting so that the leading edge from the echo is as close to vertical as possible.

A thickness measurement reading appears in large text above the A-scan.

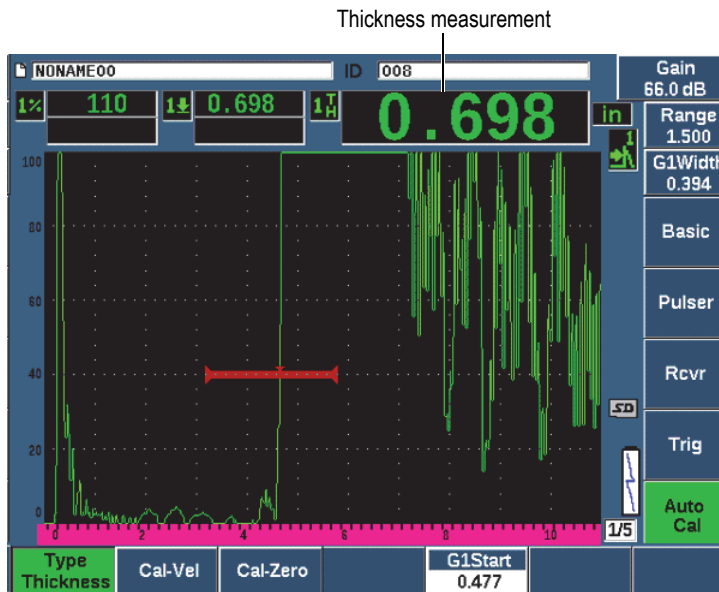


Figure 9-10 Example of a gated signal for zero calibration

10. Once a steady reading is achieved, Choose **Auto Cal > CAL Zero**.  
The screen freezes and the **Cal-Zero** box appears (see Figure 9-11 on page 171).

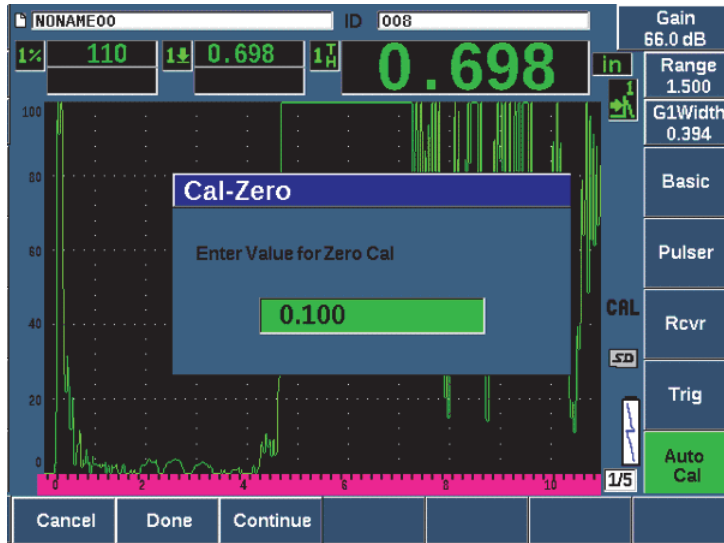


Figure 9-11 Entering the Zero Cal thickness value

11. Adjust the value to match the known thickness of the gated indication (0.100 in. in this example), and then choose **Continue** to continue to the second calibration step. The thickness value used in this part of the calibration will be stored for reference in the **Cal-Zero** parameter box.

---

**NOTE**

To exit without acquiring calibration data, press **Cancel**.

---



Figure 9-12 Example of a gated signal for velocity calibration

12. Couple the transducer to the thick calibration block step.  
In this example, the transducer is coupled to the 0.500 in. step.
13. Use the G1Start button (P5 key) to position gate 1 so that the first back-wall echo from the known thickness step exceeds the gate threshold. Adjust the gain so that the echo amplitude is at approximately 80 %.
14. Once a steady reading is achieved, choose **Auto Cal** > **CAL Velocity**.  
The screen freezes and the **Enter Value for Velocity Cal** box appears.
15. Adjust the value to match the known thickness of the gated indication (0.500 in. in this example), and then choose **Done** to complete the calibration process (see Figure 9-13 on page 173).

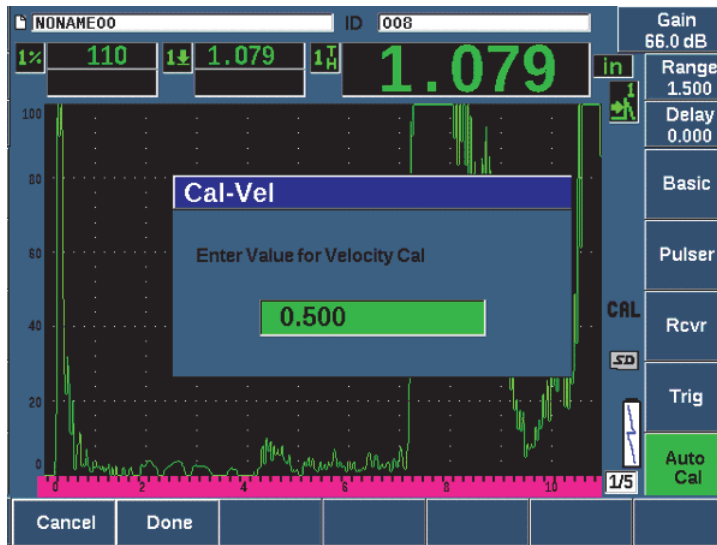


Figure 9-13 Entering the Velocity Cal thickness value

## 9.7 Calibrating in Echo-to-Echo Mode

The sample echo-to-echo calibration described below is performed using Evident delay line transducer part number V202-RM, with a frequency of 10.0 MHz and an element diameter of 6 mm (0.25 in.).

In Echo-to-echo mode, the calibration requires a test block with only one known thickness, made from the material to be measured. Ideally, the thickness measurement is very close to the expected thickness of the material to be inspected. Echo-to-echo mode measures the distance between two actual indications, one representing the measurement start point and one representing the measurement end point. This eliminates the need for zero offset calibration, since the effects that cause a zero offset are accounted for by gating the start-point indication. Therefore, in an Echo-to-echo mode calibration, the instrument must only calibrate for material velocity to provide accurate readings.

For this example, we are using Evident standard 5-step steel-test block, part number 2214E. The steps measure 0.100 in., 0.200 in., 0.300 in., 0.400 in., and 0.500 in.

**NOTE**

If the EPOCH 650 is set to work in metric units, the calibration process is exactly the same, except that the entries are in millimeters rather than inches.

---

**To calibrate in echo-to-echo mode using a delay line transducer**

1. Follow the initial setup procedure outlined in “Basic Setup” on page 155.
2. Connect the transducer to an appropriate cable, and then connect the cable to either of the conventional transducer connectors at the top of the instrument.  
With a zero offset of 0.000  $\mu$ s, the excitation pulse (or main bang) should appear on the left side of the screen.
3. Choose **Basic > Zero**, and then increase the value until the excitation pulse moves off the left side of the screen and the interface echo from the end of the delay line tip appears on the screen.
4. Verify that the echo represents the end of the delay by tapping your finger on the end of the couplant-coated delay line.  
This dampens the signal and the echo should jump up and down on the screen.
5. Choose **Basic > Zero**, and then increase the value to move this echo to the left side of the screen so that it is barely visible.  
At least two gates must be active to acquire an echo-to-echo measurement. Gate Tracking must also be active.
6. Activate gate 1 and gate 2, by selecting **Gate 1 > Status = On** and **Gate 2 > Status = On**.
7. Select **Gate Setup > G2 Tracks = On** so that gate 2 tracks gate 1.  
For more information on gate tracking activation, see “Gate Tracking and Echo-to-Echo Measurements” on page 142.
8. Select **Auto Cal > Type = G2-1**.
9. Couple the transducer to the calibration block.  
For this example, the transducer is coupled to the 0.300 in. step.
10. Use the GATES key to position gate 1 so that the first back-wall echo from the known thickness step exceeds the gate threshold.
11. Use the GATES key to position the separation of gate 1 and gate 2 so that the second back-wall echo from the known thickness step exceeds the gate 2 threshold.

12. Adjust the gain so that neither signal is saturated, and so that the echo amplitude in gate 2 is above 50 %.
- A thickness measurement reading appears in large text above the A-scan, labeled 2-1.

### TIP

In attenuating materials, it might be impossible to bring the second indication above 50 % while avoiding saturation of the first signal. If this is true, try using the **Edge** detection mode instead of the peak detection to ensure accurate measurements (see “Gate Measurement Modes” on page 138 for details).

### NOTE

Ensure that gate 1 and gate 2 are capturing successive back-wall echoes, not multiple echoes from the end of the delay line tip.

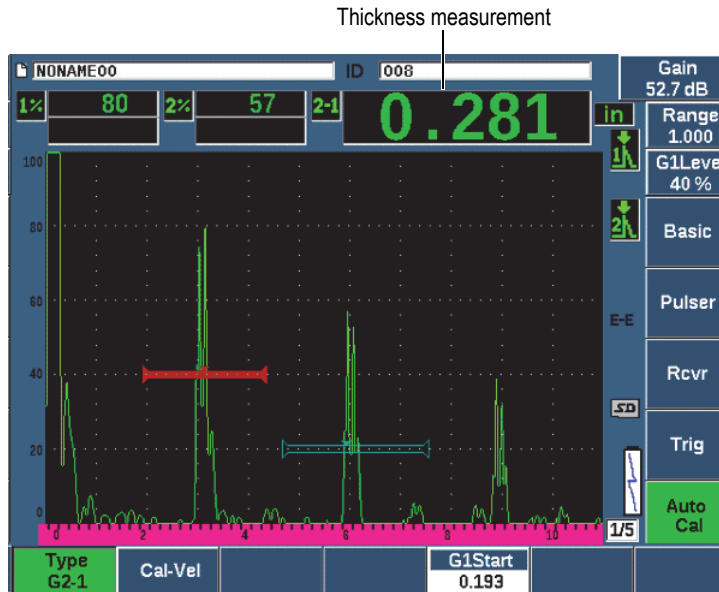


Figure 9-14 Example of gated signals for velocity calibration

- Once a steady reading is achieved, choose **Auto Cal > Cal-Vel**.  
The screen freezes and the **Cal-Vel** box appears (see Figure 9-15 on page 176).

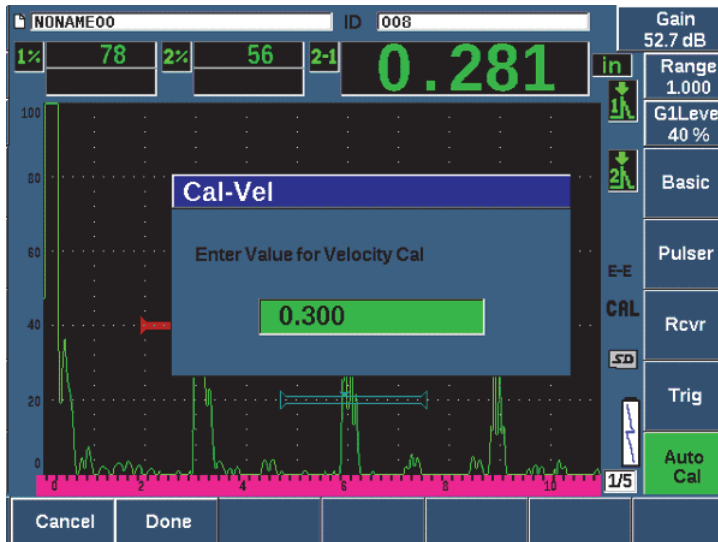


Figure 9-15 Entering the Velocity Cal thickness value

- Adjust the value to match the known thickness of the gated indication (0.300 in. in this example), and then choose **Done** to complete the calibration process.

---

**NOTE**

If for any reason you need to exit without acquiring calibration data, press **Cancel**.

---



## 9.8 Calibrating to Known Sound Path Values with an Angle Beam Transducer

The following sample angle beam calibration procedure is performed using an Evident transducer part number A430S-SB with a frequency of 2.25 MHz and an element size of 15.88 mm × 15.88 mm (0.625 in. × 0.625 in.). The transducer is mounted on a 45° wedge, part number ABWS-6-45. An Evident IIW Type I carbon-steel calibration block, part number TB7541-1, is used.

### To calibrate using an angle beam transducer

1. Follow the initial setup procedure outlined in “Basic Setup” on page 155.
2. Connect the transducer to an appropriate cable, and then connect the cable to either of the conventional transducer connectors at the top of the instrument.
3. Choose **Trig > Angle**, and then enter the correct refracted angle for the transducer/wedge combination (45° for this example).
4. Choose **Basic > Velocity**, and then enter the approximate shear-wave velocity of the material being inspected (3.240 m/s (0.1280 in./μs) in this example using carbon steel).
5. Choose **Basic > Range**, and then enter an appropriate range for the test block being used (300.00 mm (12.000 in.) in this example using carbon steel).

Review the following procedures:

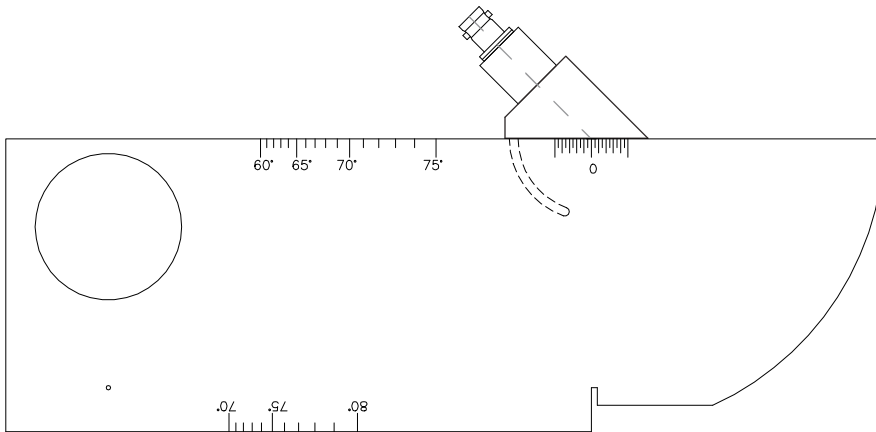
- “Locating the Beam Index Point” on page 177
- “Verifying the Refracted Angle” on page 179
- “Calibrating for Distance” on page 181
- “Calibrating for Sensitivity” on page 185

### 9.8.1 Locating the Beam Index Point

The beam index point (BIP) is the point at which the sound leaves the wedge and enters the material with maximum energy. The following procedure provides a method to identify the BIP for your probe/wedge.

#### To locate the BIP

1. Couple the probe to the test block at the 0 mark.



**Figure 9-16 IIW block with probe at 0 mark**

2. Manipulate the probe until a high-amplitude signal appears on the screen after the excitation pulse.  
This is the reflection from the large arc of the block that is located on the Type I block at 100 mm (4.00 in.).
3. Move the probe forward and backward to bring the echo to its maximum amplitude (peak).
4. Ensure the echoes do not exceed 100 %. If necessary, reduce the gain.

---

**TIP**

The peak memory is an excellent tool for finding the BIP. Press PEAK MEM to turn peak memory on. This feature draws and collects the echo envelope of the signal while also drawing the live waveform (see Figure 9-17 on page 179). Match the live waveform with the maximum point corresponding to the previously accumulated echo dynamic curve. Press PEAK MEM again to turn peak memory off.

---

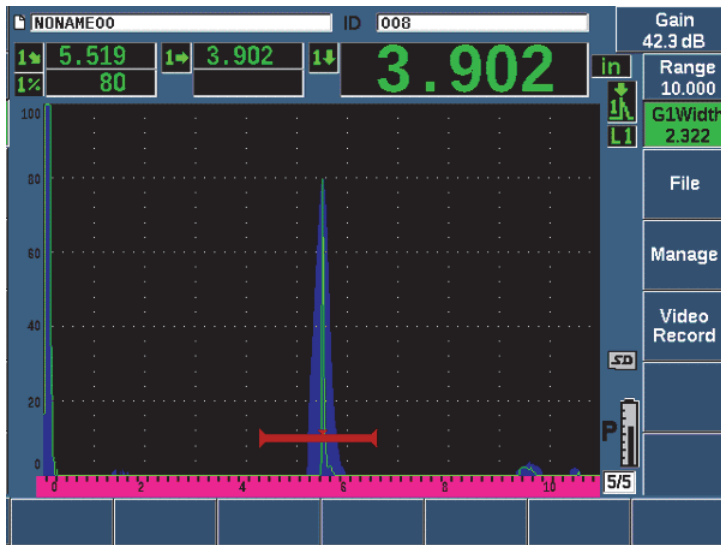


Figure 9-17 Using the Peak Memory feature to find the BIP

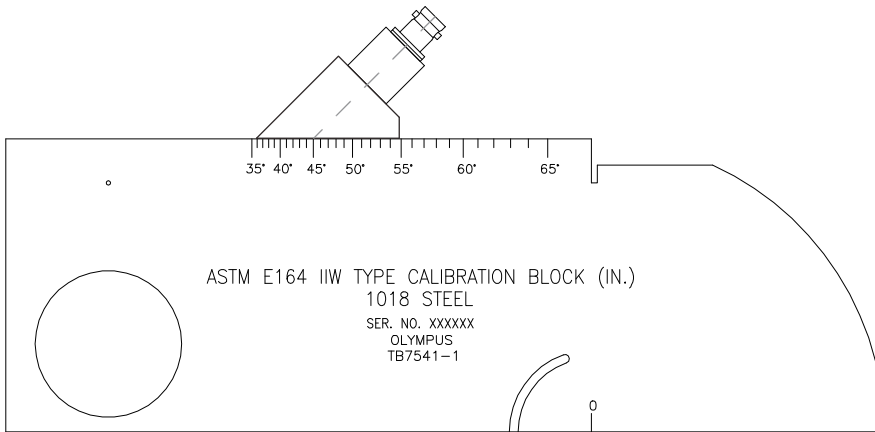
5. Hold the probe stationary once the signal is peaked up and mark the side of the transducer wedge directly over the 0 mark on the block. This is the BIP, the point at which the sound leaves the wedge and enters the material with maximum energy.

## 9.8.2 Verifying the Refracted Angle

The expected refracted angle of the probe should already have been entered in the EPOCH 650 in the initial steps of the calibration procedure. Although the wedge may be marked 45°, for example, the actual refracted angle could be slightly different due to the properties of the test material or the amount of wear on the wedge. It is necessary to verify the actual angle. This ensures that the EPOCH 650 sound path calculations are accurate.

### To verify the refracted angle

1. Position the probe over the appropriate angle mark on the block (45° in this example).



**Figure 9-18 The IIW block with probe at the 45° mark**

2. Move the probe backward and forward to maximize the amplitude of the echo coming from the large circular hole in the side of the block. The circular hole may be filled with Plexiglas, but the procedure is the same.

---

**TIP**

Press PEAK MEM to use the Peak Memory feature to help find the peak of the signal.

---

3. Hold the probe stationary once the signal amplitude reaches a maximum and then note the degree mark on the block that is aligned with the BIP, which was marked on the side of the wedge in the procedure of “Locating the Beam Index Point” on page 177.  
This is the actual refracted angle (Beta) for this particular transducer and wedge in steel.
4. If this refracted angle value (Beta) differs from the value entered previously, select **Trig > Angle**, and then enter the corrected angle.

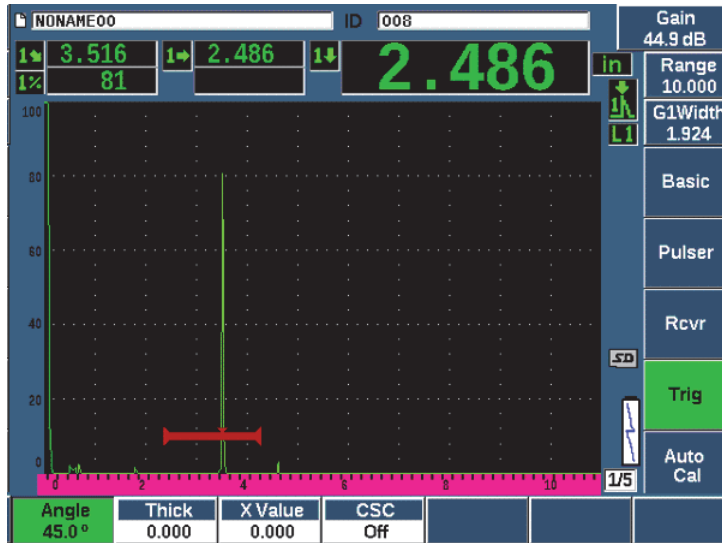


Figure 9-19 Verifying the refracted angle

### 9.8.3 Calibrating for Distance

The ASTM E-164 IIW Type I block, which has a crescent cut in the side, produces echoes at 100 mm (4 in.) and 225 mm (9 in.) on the screen, which are used for sound path distance calibration. The following procedure uses the Evident IIW Type I carbon steel calibration block, part number TB7541-1. For information on distance calibration with other standard calibration blocks, see “Common Angle Beam Calibration Block Diagrams” on page 193.

#### NOTE

If the EPOCH 650 is set to work in metric units, the calibration process is exactly the same, except that the entries are in millimeters rather than inches.

#### To calibrate for sound path distance

Choose **Basic > Range**, and then set the value to 300 mm (12.00 in.).

This should ensure that the echoes from the block are visible on screen.

1. Select **Auto Cal > Type = Soundpath**.
2. Couple the transducer to the calibration block so that the BIP is directly over the 0 mark on the ASTM test block. Do not move the transducer from this point during the distance calibration step.
3. Use the G1Start button (P5 key) to position gate 1 so that the first reflection from the arc of the block is exceeding the gate threshold.  
This reflection should be close to 100 mm (4 in.).
4. Press dB, and then adjust the gain setting so that the echo amplitude is at approximately 80 %.

### TIP

The AUTO XX% can be used to automatically adjust the gain to set the gated echo amplitude to XX% of full screen height (the default XX value is 80 %). To activate this feature, press 2<sup>ND</sup> F, (AUTO XX%).

The sound path measurement reading appears in the Reading 2 box (see Figure 9-20 on page 182).



Figure 9-20 Example of a gated signal for zero calibration

5. Once a steady reading is achieved, choose **Auto Cal > Cal-Zero**.  
The screen freezes and the **Cal-Zero** box appears.

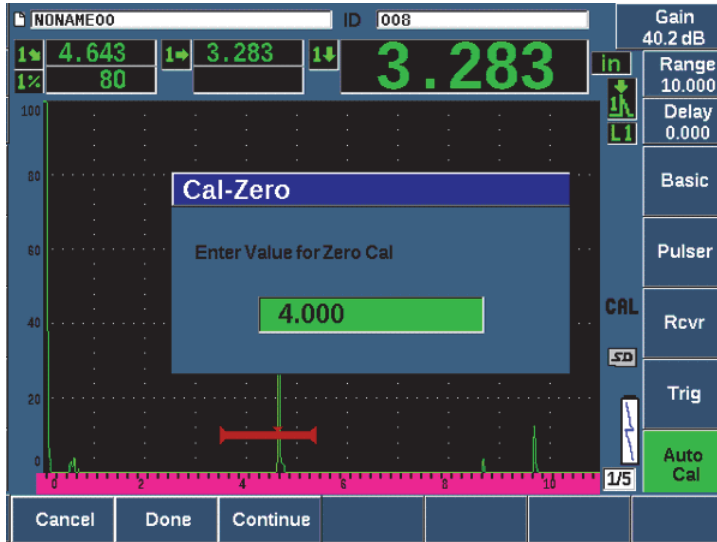


Figure 9-21 Entering the Zero Cal thickness value

6. Adjust the value to match the known thickness of the gated indication (4.000 in. in this example), and then choose **Continue** to continue to the second calibration step.

#### NOTE

If for any reason you need to exit without acquiring calibration data, press **Cancel**.

7. Use the G1Start button (P5 key) to position gate 1 so that the second echo reflection from the arc of the block is within the gated region. This reflection should be close to 225 mm (9 in.) (see Figure 9-22 on page 184).

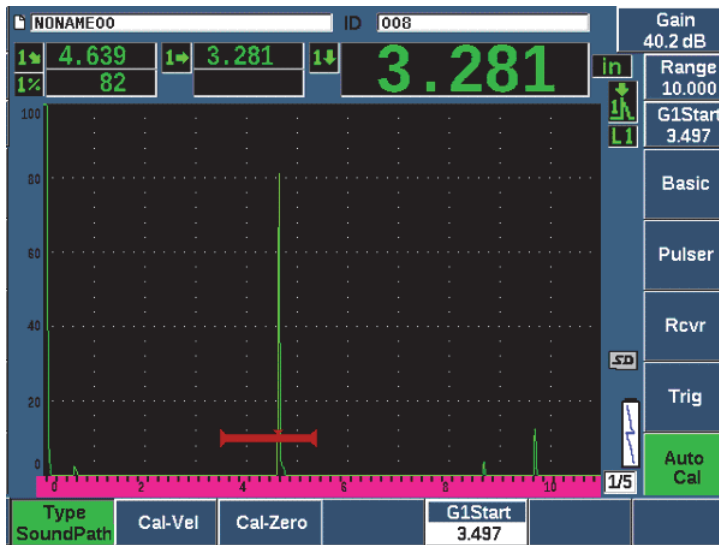


Figure 9-22 Example of a gated signal for velocity calibration

#### NOTE

Another echo might be present on the screen at approximately the 200 mm (8 in.) point. Disregard this echo as it is usually the result of beam spreading and sound bouncing off the side of the block. Ensure that gate 1 is not over this echo.

8. Press dB, and then adjust the gain so that the echo amplitude is at approximately 80 %.  
The sound path measurement reading appears in the Reading 2 box.
9. Once a steady reading is achieved, choose **Auto Cal > Cal-Vel**.  
The screen freezes and the **Enter Value for Velocity Cal** box appears (see Figure 9-23 on page 185).



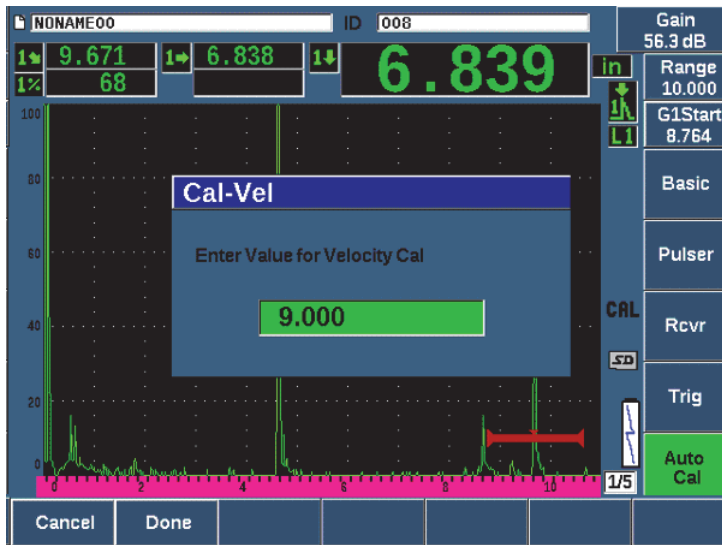


Figure 9-23 Entering the Velocity Cal thickness value

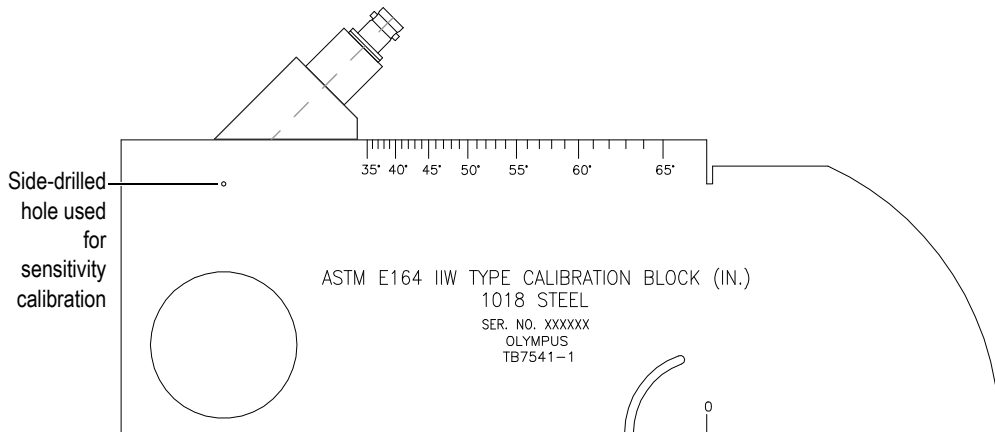
- Adjust the value to match the known thickness of the gated indication (9.000 in. in this example), and then press **Done** to complete the calibration process.

#### 9.8.4 Calibrating for Sensitivity

The final step in the angle beam calibration is to calibrate for sensitivity. This allows you to set up a reference gain level for your inspection.

##### To calibrate for sensitivity

- Couple the probe to the IIW calibration block so that the transducer is aiming at the 1.5 mm (0.060 in.) diameter side-drilled hole, used as a reference-reflector.



**Figure 9-24 The IIW block with probe facing sensitivity hole**

2. Move the probe backward and forward to maximize the amplitude of the echo from the hole. Do not confuse the reference-reflector echo from the side of the block.

---

**TIP**

Press PEAK MEM to use the Peak Memory feature to help find the peak of the signal.

---

3. Once the echo amplitude is maximized, adjust the system sensitivity (gain) to bring the reference-reflector signal to a predetermined reference line on the screen. In this example, the echo is brought to 80 % of full-screen height.
4. Press 2<sup>ND</sup> F, (REF dB) to lock in the reference-gain level and add/subtract scanning gain separately.
5. Use the **Add**, **Scan Db**, **+6 dB**, **-6 dB**, and **Off** parameters to make scanning gain adjustments once the reference gain (**Ref**) is active (see Figure 9-25 on page 187). For more information on these functions, see "Setting Reference Gain and Scanning Gain" on page 118.

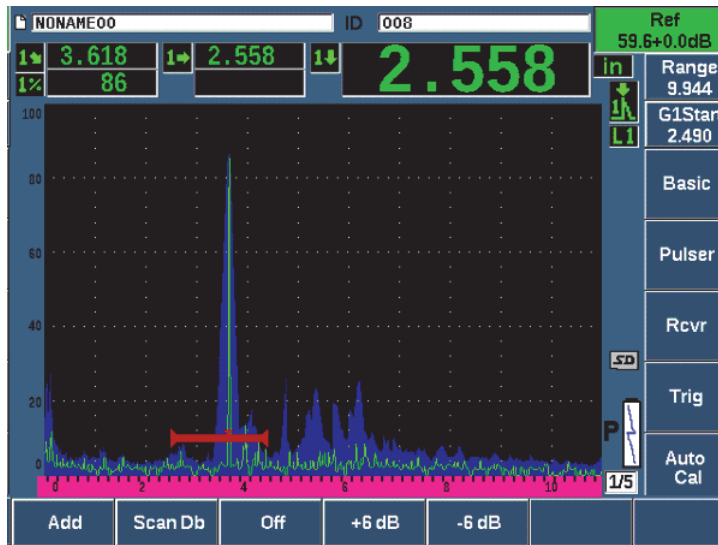


Figure 9-25 Setting the reference gain

## 9.9 Calibrating to Known Depth Values with an Angle Beam Transducer

The EPOCH 650 allows you to perform distance calibration with an angle beam transducer based on the known depth of equal sized reflectors (usually side-drilled holes) instead of known sound paths. The following sample angle beam calibration details the procedure for the depth calibration.

As with any angle beam calibration, you must also verify the beam index point (BIP), refracted angle, and perform a sensitivity calibration. It is of particular importance to verify the refracted angle before performing a distance calibration. The acquired depth measurement(s) used in this mode of calibration are based on calculations from the sound path of the reflector (direct measurement) and the value of the manually entered angle parameter. If the angle value is not correct, the distance calibration in depth mode will not be accurate.

The following procedure describes only the depth distance calibration process for the EPOCH 650. To verify the BIP and the refracted angle, and to calibrate for sensitivity, see “Calibrating to Known Sound Path Values with an Angle Beam Transducer” on page 177. The following sample angle beam calibration is performed using an Evident

transducer part number A430S-SB with a frequency of 2.25 MHz and an element size of 15.88 mm × 15.88 mm (0.625 in. × 0.625 in.). The transducer is mounted on a 45° wedge, part number ABWS-6-45. An Evident NAVSHIPS carbon-steel calibration block, part number TB7567-1, is used.

### Calibrating for Distance

The NAVSHIPS Block, which has six No. 3 side-drilled holes at various depths (see Figure 9-35 on page 197), produces echoes at various depths on the screen in 6.35 mm (0.25 in.) increments, which are used for depth distance calibration. This allows you to calibrate for various inspection ranges up to 69.85 mm (2.75 in.). For this sample calibration, the side-drilled holes at depth 12.5 mm and 38 mm (0.5 in. and 1.5 in.) are used.

For information on distance calibration with other standard calibration blocks, see “Common Angle Beam Calibration Block Diagrams” on page 193.

---

<b>NOTE</b>
-------------

If the EPOCH 650 is set to work in metric units, the calibration process is exactly the same, except that the entries are in millimeters rather than inches.

---

### To calibrate for depth distance

1. Choose **Basic > Range**, and then set the value to 100 mm (4 in.). This ensures that the echoes from the block are visible on screen.
2. Select **Auto Cal > Type = Depth**.
3. Couple the transducer to the calibration block and move the probe backward and forward to maximize the reflection from the side-drilled hole at depth 12.7 mm (0.5 in.).

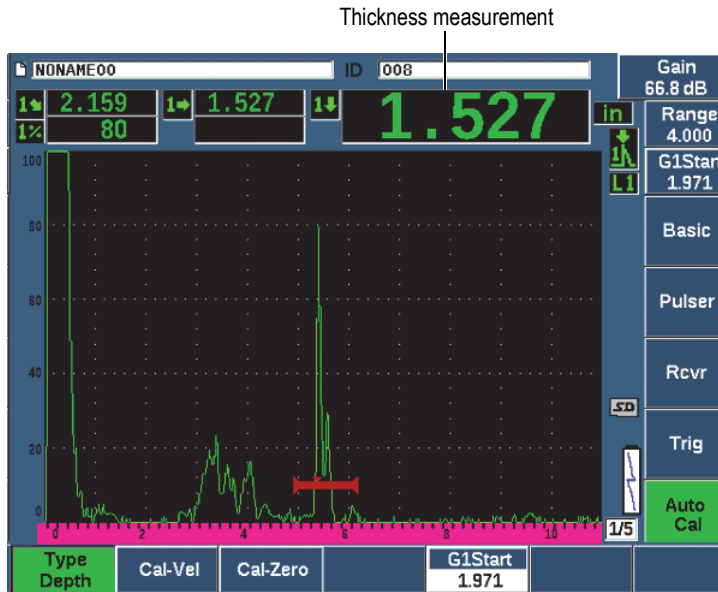
---

<b>TIP</b>
------------

Press PEAK MEM to use the Peak Memory feature to help find the peak of the signal.

---

- Use the G1Start button (P5 key) to position gate 1 so that the reflection from the first side-drilled hole is exceeding the gate threshold. This reflection should be close to 12.5 mm (0.5 in.) (see Figure 9-26 on page 189).



**Figure 9-26 Example of a gated signal for zero calibration**

- Press dB, and then adjust the gain so that the echo amplitude is at approximately 80 %.

#### TIP

The AUTO XX% feature can be used to automatically adjust the gain to set the gated echo amplitude to XX% of full screen height (the default XX value is 80 %). To activate this feature, press 2<sup>ND</sup> F, (AUTO XX%).

A thickness measurement reading appears in large text above the A-scan.

- Once a steady reading is achieved, choose **Auto Cal** > **Cal-Zero**.  
The screen freezes and the **Cal-Zero** box appears (see Figure 9-27 on page 190).

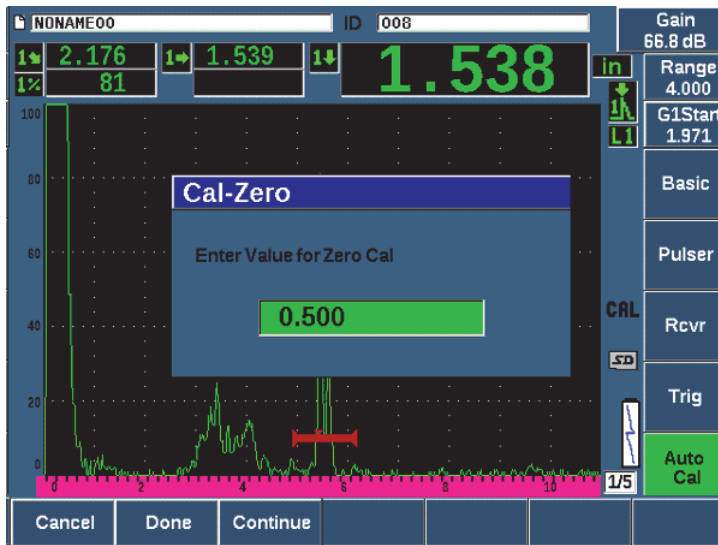


Figure 9-27 Entering the Zero Cal thickness value

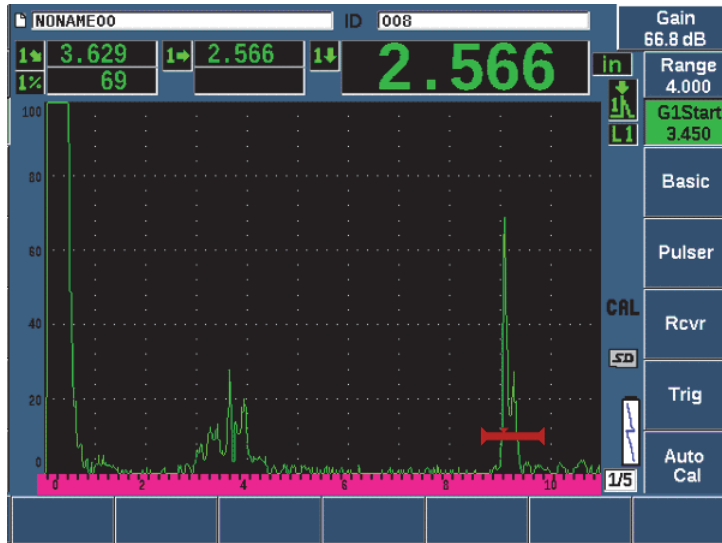
7. Adjust the value to match the known thickness of the gated indication (0.500 in. in this example), and then choose **Continue** to continue to the second calibration step (see Figure 9-28 on page 191).

---

**NOTE**

If for any reason you need to exit without acquiring calibration data, press **Cancel**.

---



**Figure 9-28 Example of a gated signal for velocity calibration**

8. Press the G1Start button (P5 key) to position gate 1 so that the reflection from the second side-drilled hole is within the gated region.  
This reflection should be close to 38.1 mm (1.5 in.).
9. Press dB and adjust the gain so that the echo amplitude is at approximately 80 %.  
A thickness measurement reading appears in large text above the A-scan.
10. Once a steady reading is achieved, choose **Auto Cal > Cal-Vel**.
11. Adjust the value in the Cal-Vel dialog box to match the known thickness of the gated indication (see Figure 9-29 on page 192).

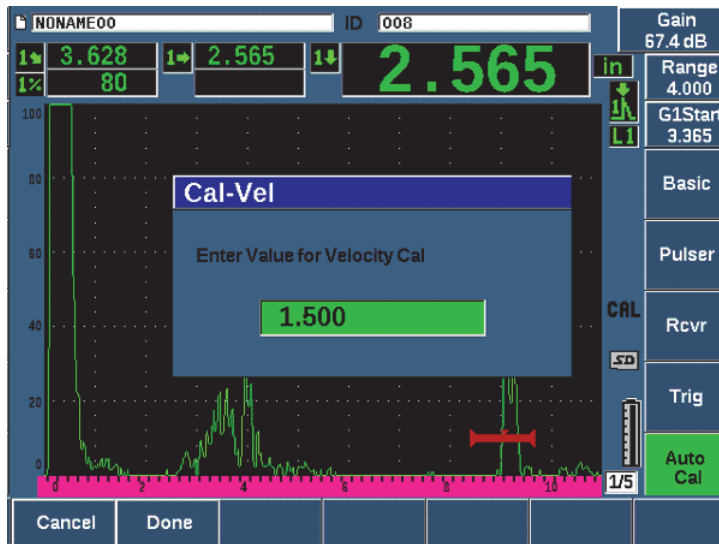


Figure 9-29 Entering the Velocity Cal thickness value

12. Choose **Done** to complete the calibration process.

## 9.10 Curved Surface Correction

The EPOCH 650 ultrasonic flaw detector provides for surface distance correction when inspecting pipes, cylinders, and other curved surfaces using an angle beam transducer. This applies only to inspections where the surface of the test piece is curved in the direction of the sound path of the transducer. This feature corrects the horizontal distance and depth to reflector measurements based on part thickness and part diameter. The correction is applicable for curved surface inspections where the transducer is placed on the outer diameter of the part. Curved surface correction can also be applied to solid cylinders (bars).

### To activate curved surface correction

1. Select **Trig > CSC = Outer Dia** or **Bar** to activate curved surface correction for either tubular or solid cylinders.

The Curved Surface Correction icon (**CSC**) appears in the flag area.



2. Choose **Trig > Diameter**, and then enter the outer diameter of the inspection piece.
3. If using **Trig > CSC = Outer Dia**, choose **Trig > Thick** and then enter the wall thickness of the inspection piece.

## 9.11 Common Angle Beam Calibration Block Diagrams

Figure 9-30 on page 193 to Figure 9-36 on page 198 illustrate calibration blocks commonly used with angle beam probes.

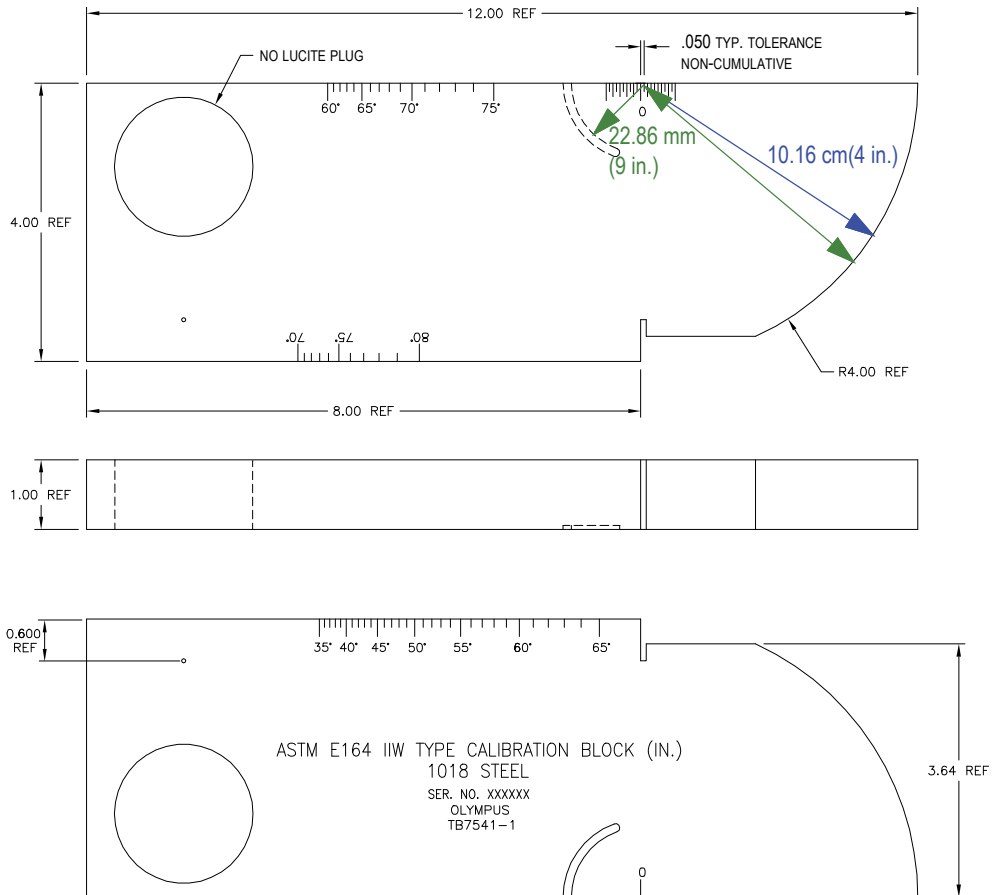


Figure 9-30 The ASTM E164 IIW type calibration block (P/N: TB7541-1)

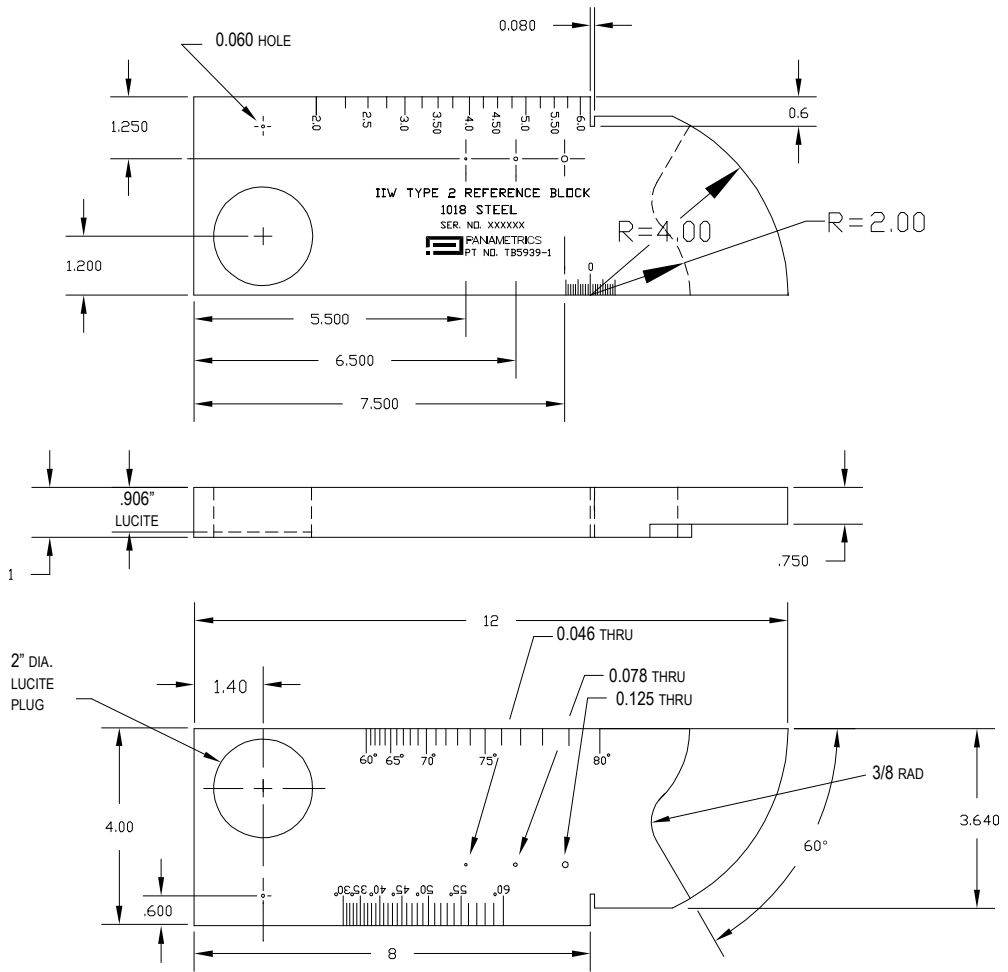
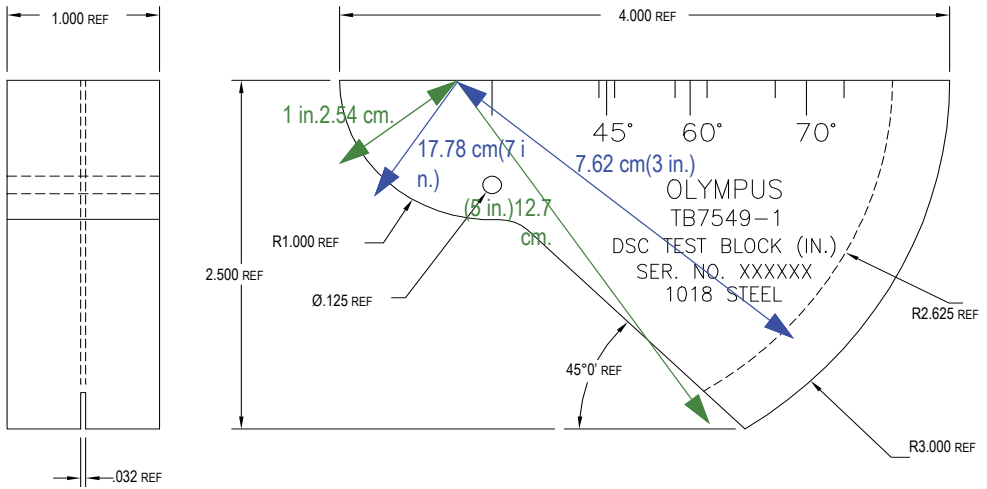
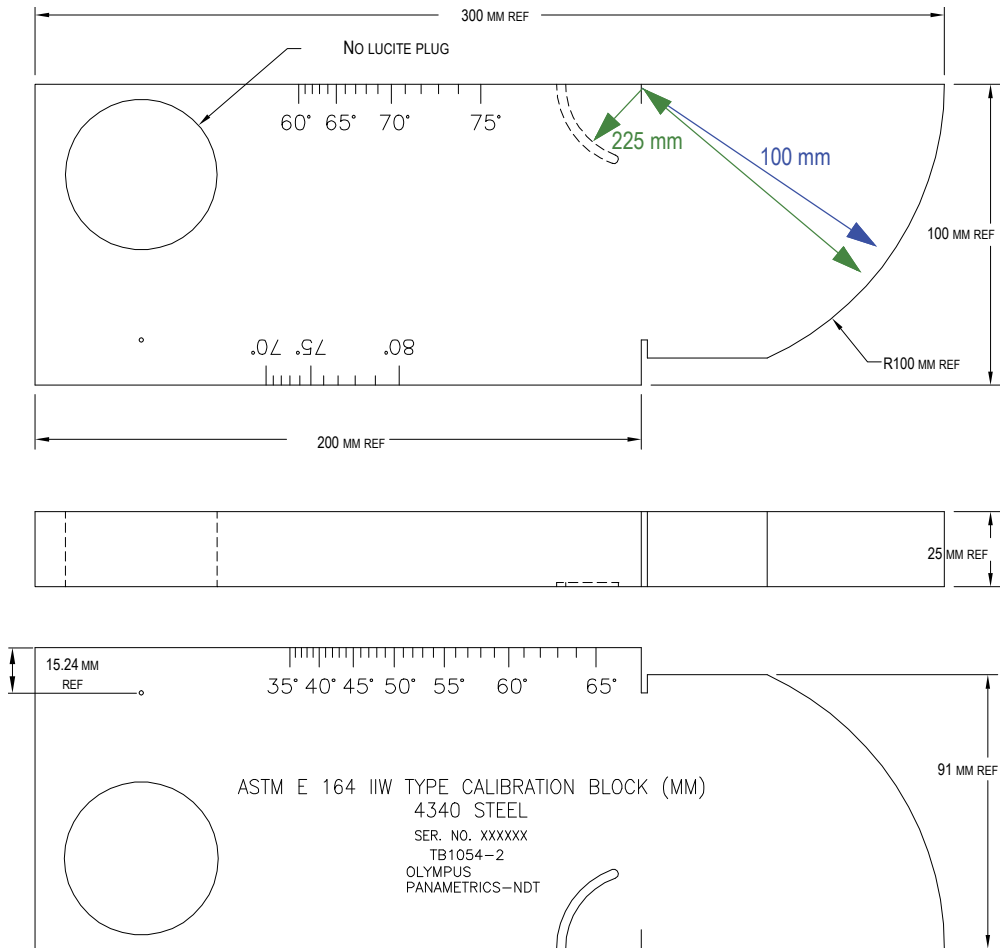


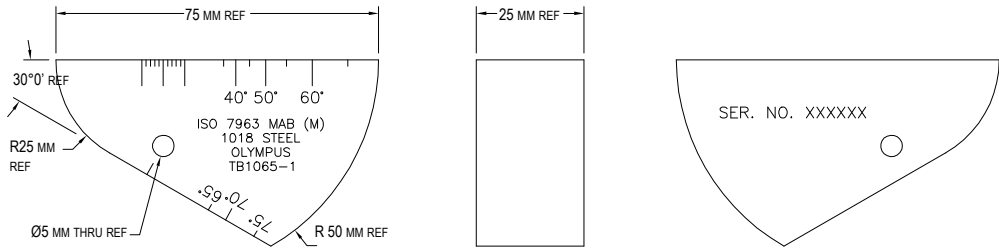
Figure 9-31 The IIW type 2 reference block (P/N: TB5939-1)



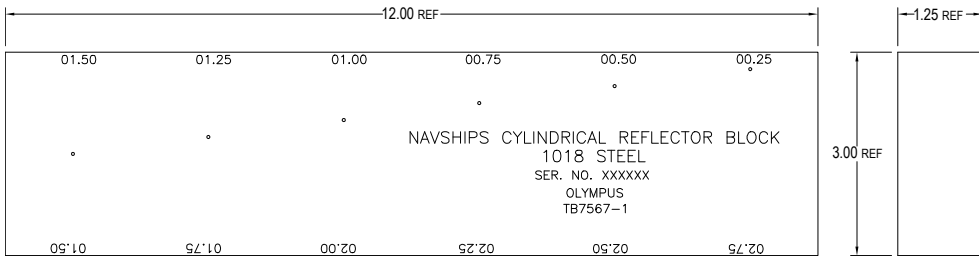
**Figure 9-32 Distance & sensitivity calibration (DSC) test block (P/N: TB7549-1)**



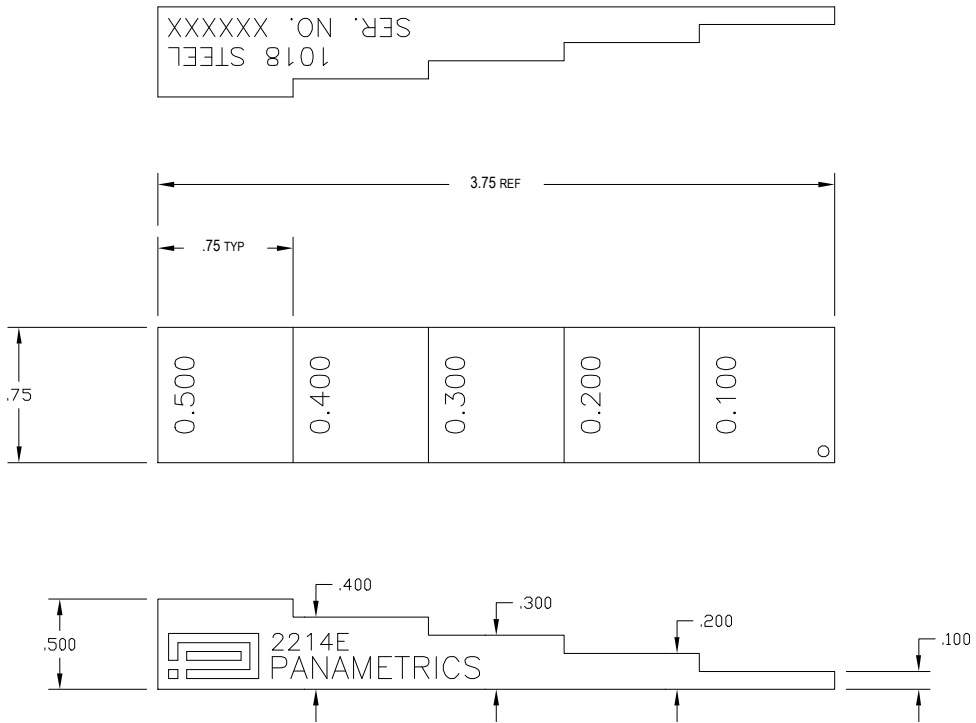
**Figure 9-33 The ASTM E164 IIW type metric calibration block (P/N: TB1054-2)**



**Figure 9-34 The ISO 7963 MAB calibration block (P/N: TB1065-1)**



**Figure 9-35 The Navships cylindrical reflector block (P/N: TB7567-1)**



**Figure 9-36 The 5-step precision thickness calibration block (P/N: 2214E)**

---

## 10. Data Logger

---

Evident has designed the data logger for ease of use, with a wide range of features. The data logger serves two basic purposes:

- To manage test and setup data
- To display certain data in a graphical format, as a screen snapshot, or as full-motion video

The data logger includes the following capabilities:

- Data is organized by alphanumeric filenames and identifier (ID) codes
- A file description, inspector ID, and location note field exists in every file
- Data capture to standard or advanced file types
- Ability to edit files, rename files, clear file contents, and delete files
- On-screen review of all file contents including snapshot and grid view
- File summary screen (without images and setup info) for measurement review to visually inspect and monitor the measurements saved in multiple IDs of the active file
- Video record and playback
- Ability to transfer data between the EPOCH 650 and a computer.
- Ability to export files, images, and data to removable memory.

Most of the capabilities of the data logger are included in three menu items:

- File  
Create different types of files, create memos within existing files, open files, view file data in multiple formats and varying detail.
- Manage  
Edit certain file information, copy files, delete files, export and import files to and from a microSD card, reset file data.

- **Video Record**  
Record the live screen to a file, review the recording, export and import video files to a microSD card.

## 10.1 Data File Types

EPOCH 650 ultrasonic flaw detectors enable you to create several file types based on application requirements. There are two standard file types, calibration and incremental, and seven advanced file types.

---

<b>NOTE</b>
-------------

For detailed information on data file types, see “Data File Types” on page 321.

---

### 10.1.1 Calibration file type

A calibration (CAL) file is designed specifically for storing calibration setups. Calibration files have space to store one single ID with its corresponding waveform and data. Separate calibration files are created for the different transducers, materials, or test parts being used. The advantage to storing setup data in calibration files is that the data can be quickly recalled to the live screen using the Quick Recall parameter.

### 10.1.2 Incremental file type

Incremental (INC) files are designed for general inspection data storage, and can contain more than one ID for storing file data. Each time the file is saved, the ID increments. If an ID number cannot increment, an error beep sounds and the momentary message “Cannot Increment ID” is shown on the display above the parameter keys. Subsequent saves overwrite measurement readings if you do not manually change the ID number first.

### 10.1.3 Advanced File Types

The EPOCH 650 features a full corrosion-style data logger with advanced file types. These files have specific configurations of IDs, which are designed for use in many corrosion applications.



### **10.1.3.1 Sequential**

A sequential (SEQ) file is defined by a starting and an ending ID number. The resulting file includes the starting and ending points and all points in between.

### **10.1.3.2 Sequential with Custom Points**

A sequential file with custom points (SEQ + CPT) is defined by a starting and ending ID number plus a series of custom points. The resulting file includes the starting and ending points and all points in between.

### **10.1.3.3 2-D Matrix Grid**

A two dimensional (2D) file sequence begins with the ID number that refers to the first column and the first row. Then the column (or row) increments one value at a time until the sequence reaches the last column (or row) value while the other dimension stays constant. At this point, the other dimension increases from its first to its next value. This continues until the ID number that refers to the last column and last row is reached.

### **10.1.3.4 2-D EPRI**

The 2-D EPRI file (2DEPR) is the same as the standard 2-D grid file type except for a minor change in the way alpha characters increment.

### **10.1.3.5 2-D Matrix Grid with Custom Point**

A 2-D matrix grid with custom points (2D + CPT) file is the same as a standard 2-D matrix grid file with the addition of custom points. Custom points allow multiple readings per grid ID number to be assigned.

### **10.1.3.6 3-D Matrix Grid**

A three-dimensional (3D) grid file sequence begins with the ID number that refers to the first column, the first row, and the first point. Then the point (or column, or row) increments one value at a time until the sequence reaches the last point (or column, or row) value while the other two dimension values stay constant. Then, another dimension increments from its first to its next value. This continues until the ID number that refers to the last column, last row and last point is reached. You can select either columns, rows, or points to increment first and one of the remaining two selections to increment second.

### 10.1.3.7 Boiler

A boiler (BOILER) file is a special file type designed specifically for boiler applications. A common method for identifying a thickness measurement location is by a 3-D approach. The first dimension is Elevation, which refers to the physical distance from the bottom to the top of the boiler. The second dimension is Tube Number, which refers to the number of boiler tubes that need inspection. The third dimension is the Custom Point, which refers to the actual thickness reading location at the specified elevation on the specified tube. When these three dimensions are combined, a single ID number is formed to precisely identify the exact location of each thickness reading.

## 10.2 Data Logger Storage Capacity

The EPOCH 650 ultrasonic flaw detector data logger can store over 100000 IDs on 2 GB of available internal memory.

## 10.3 Saving Data to Files

The EPOCH 650 allows you to save data whenever there is an active file open with an active ID. If there is no active ID and you try to save, the instrument displays the error message “No active ID” at the top of the display. For more information, see “Open” on page 209.

There is no Save button in the File menu because data is usually captured and saved from the live screen.

### To save data to an active file

- ◆ Press 2<sup>ND</sup> F, (SAVE) on the adjustment knob configuration or SAVE on the keypad configuration to save data.

The following information is saved:

- File name
- ID code
- Alarm conditions
- Gate measurement modes
- Sound path leg for each gate

- Up to five measurement reading box values (all active user-selected measurements on the instrument screen).
- A-scan waveform
- Peak memory envelope or peak hold waveform, if active
- Complete setup parameters
- Flag status (FREEZE, zoom, PEAK MEM, etc.)
- Active software features: DAC/TCG, DGS/AVG, AWS D1.1/D1.5
- Software feature/option setups

## 10.4 Data Logger Menus

The data logger is divided into three main menu items: File, Manage, and Video Record.

### 10.4.1 File Menu

Following are the parameters in the File menu (see Figure 10-1 on page 204):

- Open
- Create
- Quick Recall
- Memo
- Last ID
- Select ID

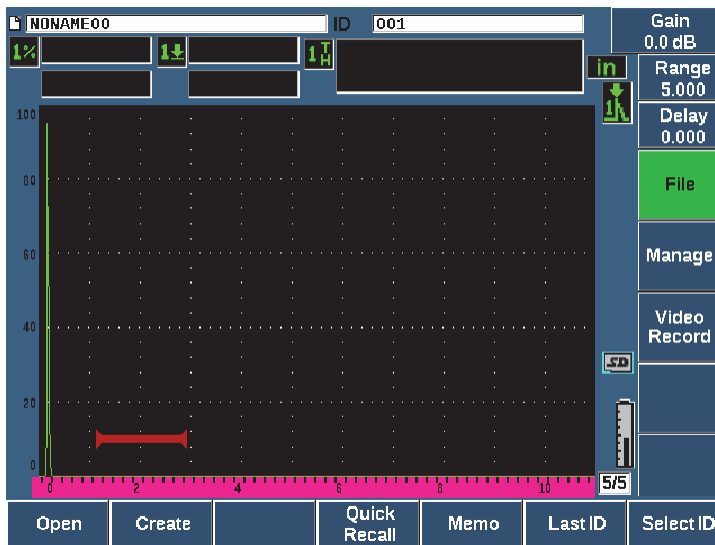


Figure 10-1 The File menu parameters

### 10.4.1.1 Create

Although the Create parameter is the second item in the File menu, you must first create a file before you can save file data (the EPOCH 650 does create a default file: NONAME00). Files can be created on the instrument, or in the GageView Pro software and transferred to the instrument.

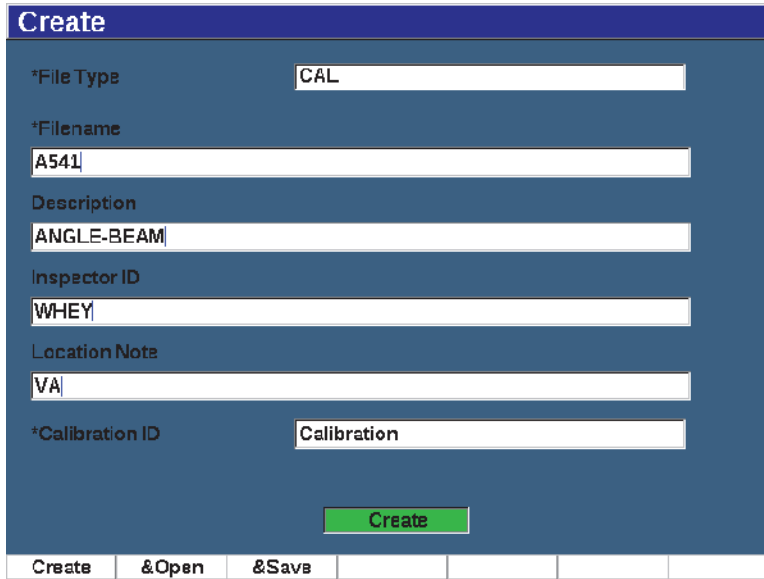
Each time you save file data, it is linked to a file identifier (ID). The number of IDs in a file depends on the file type selected and the number of data sets the you have saved. On the main screen of the EPOCH 650, the currently open file ID is displayed at the top left corner.

#### To create CAL or INC files

1. Choose **File > Create** (P2 key) to open the **Create** setup page (see Figure 10-2 on page 205).

**NOTE**

Required fields in the **Create** setup page are marked with an asterisk (\*).



The screenshot shows a software interface titled "Create" with a dark blue header. Below the header are several input fields with labels to their left. The fields are: "\*File Type" with the value "CAL"; "\*Filename" with the value "A541"; "Description" with the value "ANGLE-BEAM"; "Inspector ID" with the value "WHEY"; "Location Note" with the value "VA"; and "\*Calibration ID" with the value "Calibration". A green "Create" button is centered below the fields. At the bottom of the screen is a menu bar with the following items: "Create", "&Open", "&Save", and several empty menu slots.

**Figure 10-2 The Create setup page**

2. In the **Create** setup page, use the arrow keys or adjustment knob to select the file type (**INC** or **CAL**).
3. Press **NEXT** to highlight the **Filename** field.
4. Press **Edit** (P1 key) and then enter a file name (up to 32 characters long) using the virtual keyboard and the F1–F5 keys (see Figure 10-3 on page 206).

The screenshot shows a 'Create' form with the following fields and values:

- \*File Type: CAL
- \*Filename: A54 (highlighted in green)
- Description: ANGLE-BEAM
- Inspector ID: WHEY
- Location Note: VA
- \*Calibration ID: (empty)

Below the Calibration ID field is a numeric keypad with the following layout:

A	B	C	D	E	F	G	H	I	J	K	L	M
N	O	P	Q	R	S	T	U	V	W	X	Y	Z
0	1	2	3	4	5	6	7	8	9	-	#	

At the bottom of the form is an 'Edit' button.

Figure 10-3 File name edit

**NOTE**

Special characters such as spaces, decimals, slashes, and punctuation are not permitted in the **Filename** field.

5. For each of the next three optional fields (**Description**, **Inspector ID**, **Location Note**) press NEXT, then **Edit** (P1 key) to enter information.
6. If the File Type is **INC**:
  - a) Press NEXT, then **Edit** (P1 key) to enter an optional **ID Prefix**.  
This prefix will save as part of the ID but will not increment.
  - b) Enter a **Start ID** for the INC file.
7. If the File Type is **CAL**, press NEXT, then **Edit** (P1 key) to enter a calibration ID.
8. Once you have completed the file setup, press NEXT to highlight the **Create** button.
9. Press **Create** (P1 key) to exit the setup page and create the file.

You can also choose **&Open** (P2 key) to create and open the file in a single step, or **&Save** (P3 key) to create, open, and save the current settings to the current file in a single step.

### NOTE

Once a file is created, you must open the file before trying to save information. This is a separate function from Create. See “Selecting a File as the Active Storage Location.” on page 209 for instructions on how to open a file.

### To create Advanced files

1. Choose **File > Create** (group 5/5) to open the **Create** setup page (see Figure 10-4 on page 207).
2. Press **Advanced** (P3 key) to select the **Advanced** file type.
3. Press NEXT to highlight the **Filename** field and enter a file name.
4. Enter optional information in the **Description**, **Inspector ID**, and **Location Note** fields.

The screenshot shows the 'Create' setup page with the following fields and values:

- \*File Type:** A grid of letters A-M and numbers 0-9, with 'C' highlighted in green.
- \*Filename:** WELD-STC
- Description:** SPCL-SETUP
- Inspector ID:** BRAD
- Location Note:** BOILER

Navigation buttons on the right include left arrow, right arrow, double right arrow, DEL, and INS. A 'Setup' button is at the bottom center. The 'Edit' button is at the bottom left.

Figure 10-4 Creating advanced file type

5. Press **NEXT** to highlight the **Setup** field.
6. Press **Ok** (P1 key).
7. In Create page two, press a parameter key (P1–P7) to select a type (see Figure 10-5 on page 208):
  - **SEQ**
  - **SEQ+CP**
  - **2D**
  - **2DEPR**
  - **2D+CP**
  - **3D**
  - **BOILER**
8. Enter the required (and optional if desired) information for the selected type.
9. Press **NEXT** to highlight the **Create** button.

The screenshot shows a software dialog box titled "Create" with a dark blue header. The main area has a light blue background and contains several input fields and dropdown menus. The fields are labeled as follows:

- File Type:** BOILER
- ID Prefix:** (empty)
- \*Start Tube:** 1
- \*End Tube:** 20
- \*1st Inc By:** Tube
- \*2nd Inc By:** Elevation
- \*Inc Type:** Standard
- \*Custom Point:** 2
- \*Elevation:** 1

At the bottom of the dialog, there is a green "Create" button. Below the dialog, a standard Windows taskbar is visible with icons for "Create", "&Open", "&Save", and other application icons.

Figure 10-5 Advanced (Create page two)

10. Press **Create** (P1 key) to exit the setup page and create the file.



You can also choose **&Open** (P2 key) to create and open the file in a single step, or **&Save** (P3 key) to create and open the file, then save the current settings to the file in a single step.

### 10.4.1.2 Open

The Open parameter performs multiple actions for saved files in the data logger. The Open parameter is used to:

- Select a file as the active storage location
- View details about a specific file
- View setup and waveform data for saved IDs in a file
- Recall a file ID to bring saved data to the live screen
- View a summary of all saved data in a file
- Export file data to a microSD card

Each of these actions is described in detail below.

#### **Selecting a File as the Active Storage Location.**

The EPOCH 650 maintains a list of all files that have been created or downloaded to the instrument. To save information to a file, you must first open that file to select it as the active storage location.

The **Open** parameter allows you to use calibration files and inspection storage files at the same time within a procedure while minimizing required button presses. For example, a particular inspection may require the use of three separate transducers and therefore three calibrations, but you may wish to store all inspection data in one inspection file. In this situation, open that inspection file first.

#### **To open a file and set it to the active storage location**

1. Choose **File > Open** (see Figure 10-6 on page 210).
2. Use the knob or arrow keys to select the specific file that you want to open.

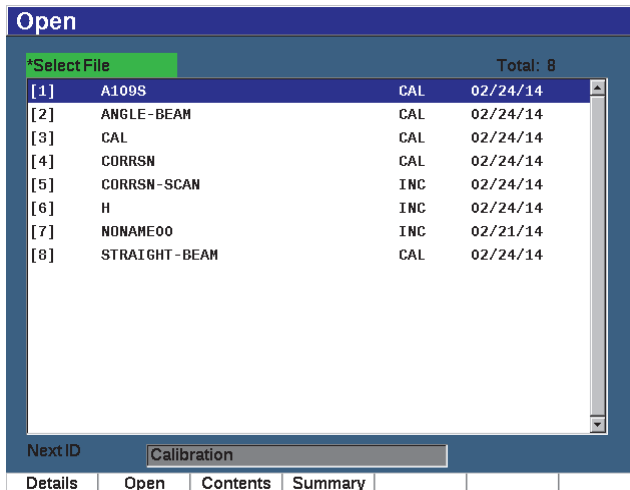


Figure 10-6 The Open page

- Press **Open** (P2 key) to open the selected file and return to the live screen. The ID of the opened file is displayed at the top of the screen (see Figure 10-7 on page 210).  
When you press 2<sup>ND</sup> F, (SAVE) from the live screen, on-screen data and settings are saved to the currently open ID.

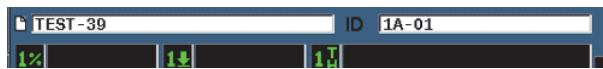


Figure 10-7 ID of open file in the live screen

### Viewing file setup information


You can view the file setup and creation information.

#### To view the setup information

- Choose **File > Open** (group 5/5), and then select the file that you want to view.
- Press **Details** (P1 key) to enter the **Details** page (see Figure 10-8 on page 211).

Details	
Filename	DGS-DL1
Description	
Inspector ID	
Location Note	
File Type	SEQ
Date Created	10/06/14 11:30 AM
Date Modified	10/06/14 11:30 AM
Total ID Count	1
Done	

Figure 10-8 The Details page

3. Press **Done** (P1 key) to return to the **Open** page or press  to return to the main screen.

### Viewing Setup and Waveform Data for Saved IDs in a File

Once data has been saved into a file, you are able to view contents of the saved data. The waveform and basic setup parameters are stored on one screen, and the complete setup information on another screen.

#### To view saved data

1. Choose **File > Open**, and then select the specific file that you want to view.
2. Press **Contents** (P3 key) to view the saved waveform and the basic setup data. The ID of the file being viewed is displayed at the top left corner of the screen (see Figure 10-9 on page 212).

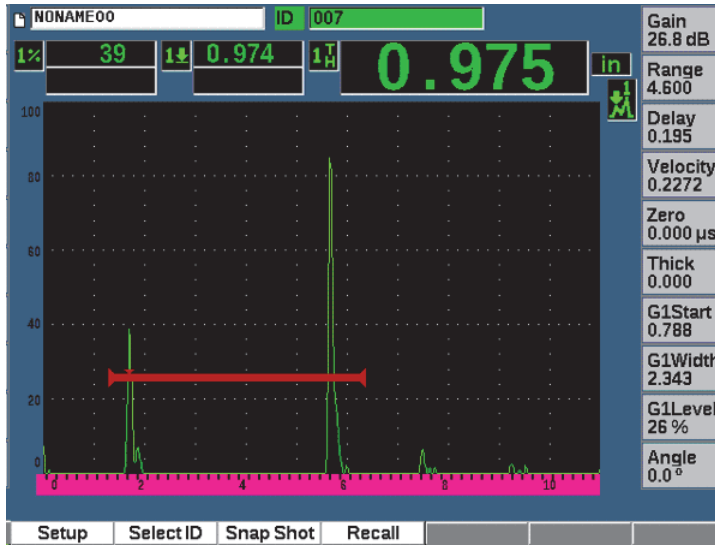



Figure 10-9 Viewing file content (waveform)

3. Press **Setup** to view the complete setup parameters for the current ID (see Figure 10-10 on page 213).


ID 002					
G1Start	0.713	G2Start	Off	GIFStart	Off
Width	0.252	Width	Off	Width	Off
Level	23 %	Level	Off	Level	Off
Alarm	Off	Alarm	Off	Alarm	Off
Velocity	0.1382 in/ $\mu$ s	Zero	4.542 $\mu$ s		
Range	1.217	Delay	0.000		
Angle	0.0 °	Thick	0.000		
CSC	Off	CSC Diameter	25.000		
PRF	380 Hz	Damp	50 $\Omega$		
Mode	P/E	Energy	100 v		
Freq		Reject	0 %		
Filter	1.5-8.5 MHz	Rect	Full		
Pulser	Spike				

Waveform	Recall	SelectID	Memo			

Figure 10-10 Viewing file content (setup)

- To switch to a different ID, use the knob or arrow keys to scroll through the saved IDs in the file.
- Press  to return to the **File > Open** menu.

### To choose from a large number of IDs

- Choose **File > Open**.
- Use the knob or arrow keys to select the specific file that you want to view.
- Press **Contents** (P3 key).
- Press **Select ID** (P2 key).
- Use the **Prev Page**, **Next Page**, or arrow keys (<< or >>) to quickly access any ID in the list.
- When you have selected the ID you want to view, press **Select** (P1 key).
- Press  twice to return to the **File > Open** menu.

## Recalling a File ID

To bring saved data to the live screen, you must recall that particular file ID. For incremental (INC) files, you must select the specific ID to be recalled. For calibration (CAL) files, recalling the file automatically recalls the parameters in the single ID saved in that file.

### To recall a file ID

1. Choose **File > Open**, and then select the specific file that you want to view.
2. Press **Contents** (P3 key) to view the saved waveform and basic setup data. The ID being viewed shows up at the top of the screen.
3. Press **Select ID** (P2 key) to display the **Select ID** page (see Figure 10-11 on page 214).
4. Use the arrow keys or adjustment knob to select the ID you want to recall.
5. Press **Select**.
6. Choose **Recall** to recall the selected ID and bring the parameters to the live screen. The notification “New setup recalled. Press any key to continue” displays at the bottom of the screen.
7. Press any key on the instrument.

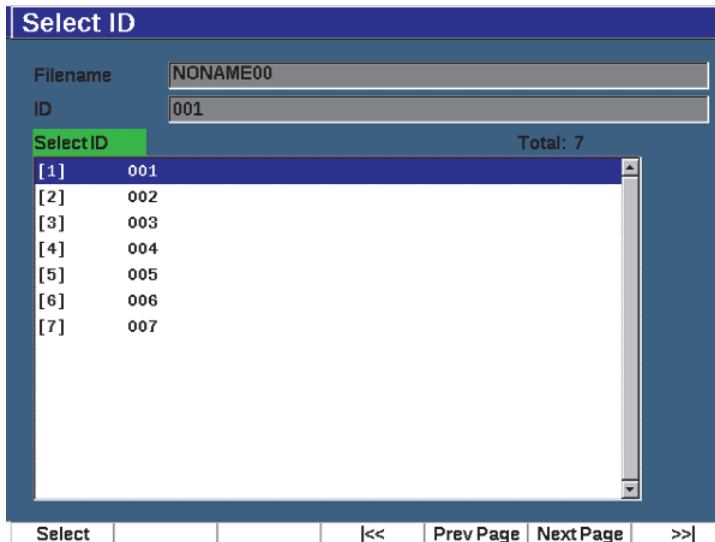


Figure 10-11 Select ID page

## Viewing a Summary of all Saved Data

After you have completed saving data to a file, you may want to view a summary of the different measurements saved in the different IDs within the file. (The measurement parameters displayed are selected from **Meas Setup > Reading Setup** [group 3/5].)

### To view a summary of all saved data in a file

1. Choose **File > Open** (group 5/5), and select the file you want to view.
2. Press **Summary** (P3 key) to view a measurement summary for all the saved IDs in the selected file (see Figure 10-12 on page 215).
3. Press **Done** (P1 key) to return to the previous screen.

Summary					
Filename	CORROSION BLOCK SCAN				Total: 18
#1	A0			in	
1%	8.75	1↓	1.499	1↑	1.500
#2	A1			in	
1%	80.00	1↓	0.498	1↑	0.498
#3	A2			in	
1%	63.00	1↓	0.750	1↑	0.750
#4	A3			in	
1%	41.25	1↓	1.000	1↑	1.001
#5	A4			in	
1%	75.25	1↓	0.750	1↑	0.750
#6	A5			in	
1%	1.75	1↓	1.323	1↑	1.324
#7	A6			in	
1%	13.00	1↓	1.230	1↑	1.230
#8	A7			in	
1%	16.50	1↓	1.088	1↑	1.088
#9	A8			in	
1%	7.00	1↓	1.078	1↑	1.078
#10	A9			in	
1%	6.75	1↓	1.126	1↑	1.126
Done	Report		<<	>>	>>

Figure 10-12 File measurement summary

### To record and export thickness data

1. Make a thickness measurement and check that the expected reading is displayed in the Reading 5 box.
2. Press **Thick Record** (P3 key).  
A .csv file is written to the microSD card.

### 10.4.1.3 Quick Recall

Quickly recalls a saved setup from a calibration file.

---

**NOTE**

Only files created using the CAL file type are displayed in the quick recall setup window.

---

#### To quickly recall a file using the recall setup

1. Select **File > Quick Recall**. (group 5/5)  
The **Recall** setup menu appears (see Figure 9-11 on page 171).

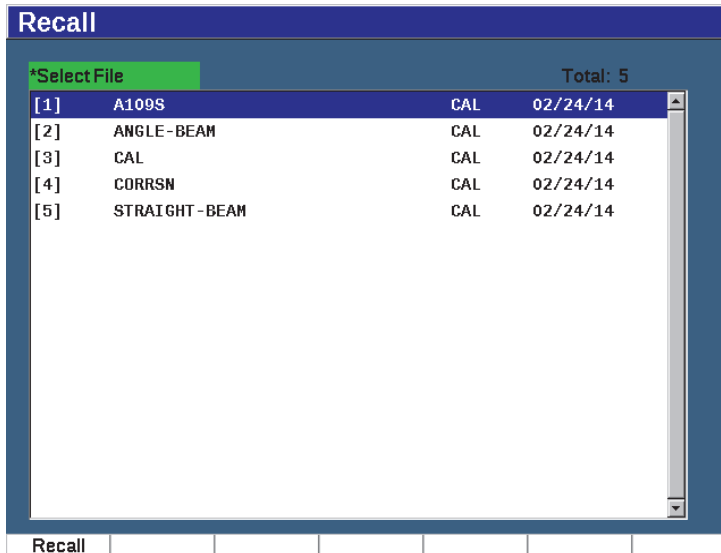


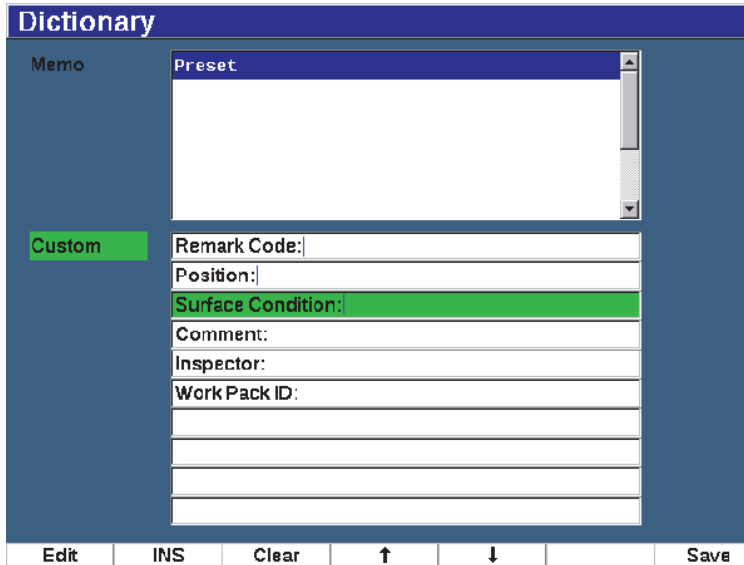
Figure 10-13 The Recall setup menu

2. Use the arrow keys or the adjustment knob to select a calibration file.
3. Press **Recall** (P1 key) to recall the selected file settings as the live instrument parameters.





4. In the **Dictionary** page, use NEXT to select one of the **Custom** labels (see Figure 10-15 on page 218).



The screenshot shows a software interface titled "Dictionary". On the left, there are two tabs: "Memo" and "Custom". The "Custom" tab is selected and highlighted in green. The main area contains a list of fields for creating a custom label. The fields are: "Remark Code:", "Position:", "Surface Condition:", "Comment:", "Inspector:", and "Work Pack ID:". The "Surface Condition:" field is currently selected and highlighted in green. Below the fields is a control bar with buttons: "Edit", "INS", "Clear", an up arrow, a down arrow, and "Save".

**Figure 10-15 Memo Dictionary page**

5. Press **INS** (P2 key) to insert the custom label into the memo and return to Memo setup page one (see Figure 10-15 on page 218).
6. Press **Edit** to add more information to the selected field.
7. Use the **Up** (P4 key) and **Down** (P2 key) arrows to move through the menu fields.
8. Press **Save** to return to the active screen when you are finished creating your memo.

Figure 10-16 Populated Memo setup page

### To erase *all* the editable text in the Memo setup page

- ◆ Press **Clear**.

#### 10.4.1.5 Last ID and Select ID

When a file is opened, it defaults to the first open ID (displayed in the ID field at the top of the screen).

### To select the last ID in the file

- ◆ Choose **File > Last ID**.

### To select from a list of all the available IDs

- ◆ Choose **File > Select ID** elect from a list of all the available IDs in the currently open file (see Figure 10-17 on page 220).

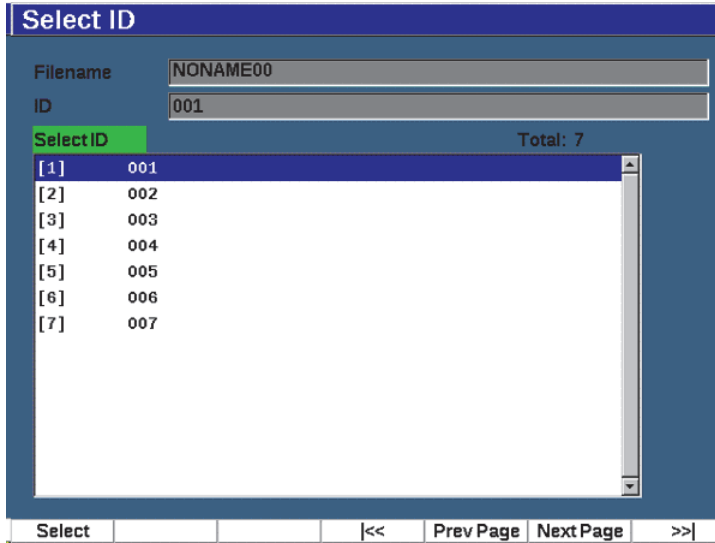
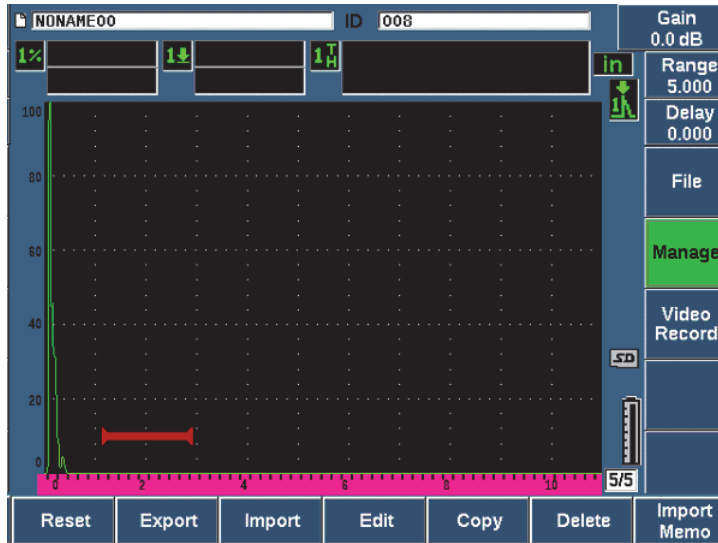


Figure 10-17 The Select ID menu

## 10.4.2 Manage Menu

This section presents the **Manage** menu (see Figure 10-18 on page 221).



**Figure 10-18** The Manage menu parameters

The parameters are as follows:

- Reset
- Export
- Import
- Edit
- Copy
- Delete
- Import Memo

#### 10.4.2.1 Reset

The EPOCH 650 ultrasonic flaw detector allows you to reset its current settings to default values when necessary. See “Resetting the Instrument” on page 82 for details on resetting the instrument.

## 10.4.2.2 Export

The **Export** parameter exports file data to the external microSD Card. Many customers use the data saved from their instruments in flaw detection reports of their findings. Rather than require manual copying of the measurements to the reports, the EPOCH 650 has the capability to export saved file data to a microSD card.

Data can be saved as in the following formats:

- .csv – can be opened in programs such as Microsoft Excel.
- .svy – a binary format that can only be used on or between EPOCH models.
- .xml – a format that is useful for using in web applications.
- .bmp – an image format that can be opened in any image viewing software.

### To export file data to the microSD card

1. Choose the **Manage** menu item.
1. Press **Export**, (P2 key) to display the **Export** setup page (see Figure 10-19 on page 223).
2. Use the arrow keys or adjustment knob to select the file that you want to export.
3. Press NEXT to highlight the **File Type** box.
4. Press **CSV** (P1 key), **Binary** (P2 key), **XML** (P3 key), **Memo** (P4 key), or **Report** (P5 key) to select a file type.

The Memo file type is saved as an XML file in the MEMO folder on the microSD card.

5. Press NEXT to highlight the **Export** button.
6. Press **Ok** (P1 key) to export the file data to the microSD card.

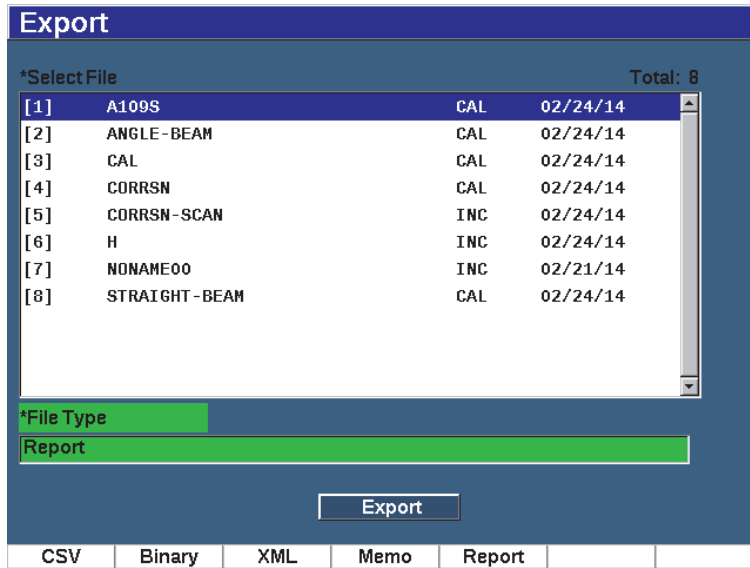


Figure 10-19 Export setup page

### 10.4.2.3 Import

The **Import** parameter imports .svy file data from the external microSD Card.

#### To import file data from the microSD card

1. Choose **Import**, (P3 key) to display the **Import** page (see Figure 10-20 on page 224).
2. Use the arrow keys or adjustment knob to select the file that you want to import.
3. Press NEXT to highlight the Import button.
4. Press **Ok** (P1 key) to import the file data from the microSD card.

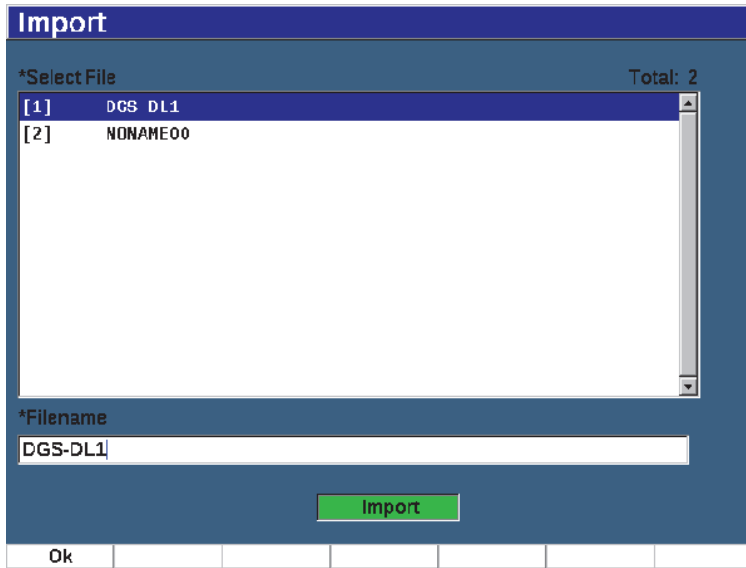


Figure 10-20 Import page

### To import memo data from the microSD card

1. Press **Import Memo**, (P7 key) to display the **Import** page (see Figure 10-21 on page 225).
2. Use the arrow keys or adjustment knob to select the file that you want to import.
3. Press **Import** (P1 key) to import the memo data from the microSD card.



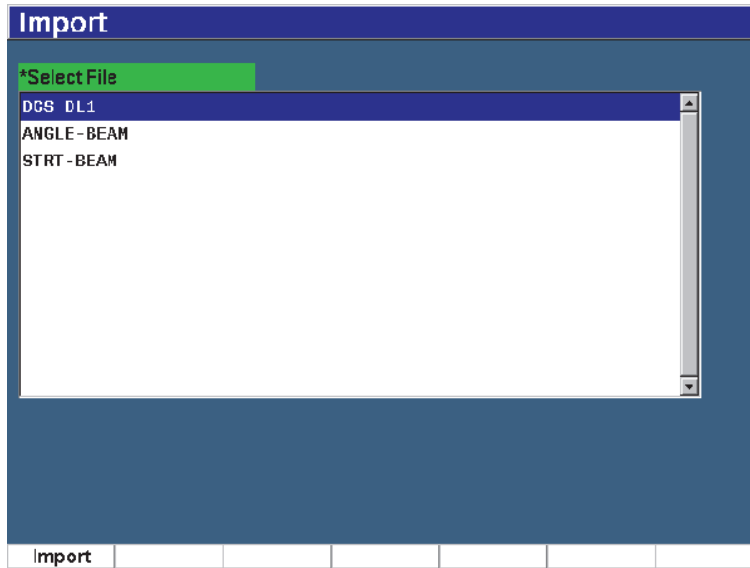


Figure 10-21 Import (memo) page

#### 10.4.2.4 Edit

The **Edit** parameter is used to edit file names and descriptions once a file has been saved.

##### To edit file creation parameters

1. Choose **Manage > Edit** (group 5/5) to display the edit page (see Figure 10-22 on page 226).

*Select File				Total: 8
[1]	A109S	CAL	02/24/14	
[2]	ANGLE-BEAM	CAL	02/24/14	
[3]	CAL	CAL	02/24/14	
[4]	CORRSN	CAL	02/24/14	
[5]	CORRSN-SCAN	INC	02/24/14	

\*Filename  
A109S

Description  
[Empty field]

Inspector ID  
[Empty field]

Location Note  
[Empty field]

Apply

Edit [ ] [ ] [ ] [ ] [ ] [ ] [ ]

Figure 10-22 The Edit setup menu

2. Select a file from the available list.  
The CAL, INC, and SEQ file types are listed.
3. Press **NEXT** to highlight the field you want to edit.
4. Press **Edit** (P1 key) to add or change information in the field.
5. Press **NEXT** to select **Apply**.
6. Press **Ok** to confirm the changes.
7. Press **↶** to return to the main screen.

#### 10.4.2.5 Copy

**Copy** is used to make a duplicate copy of a file saved on the instrument.

##### To copy a file

1. Choose **Manage > Copy** (group 5/5) to display the Copy page (see Figure 10-23 on page 227).

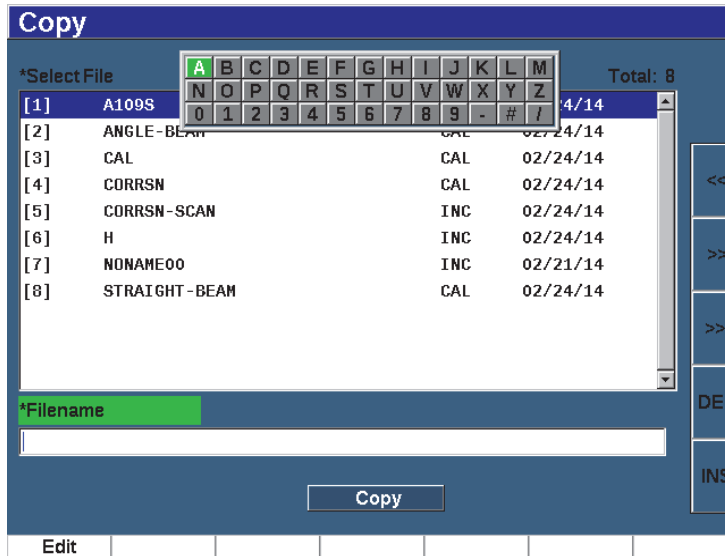



Figure 10-23 The Copy setup menu

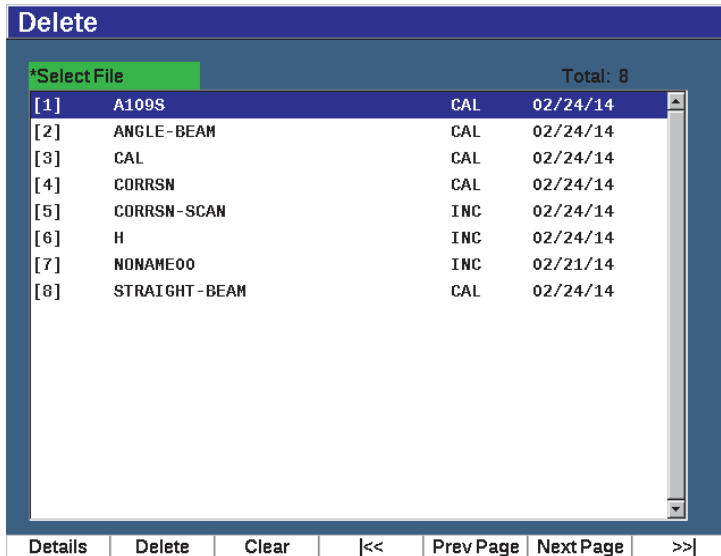
2. Select a file from the list.  
The CAL, INC, and SEQ file types are listed.
3. In the **Filename** field, enter name to give to the copied file. (The same rules mentioned previously for file names apply to this field.)
4. Select **Copy** and press **Ok** to confirm the changes. Press  to return to the main screen.

### 10.4.2.6 Delete

The **Delete** function is used to delete a saved file from the instrument. This function deletes the file name as well as all the saved data and IDs contained within it.

#### To delete a file

1. Choose **Manage > Delete**.  
The **Delete** page appears (see Figure 10-24 on page 228).



**Figure 10-24 The Delete setup menu**

2. Select from the list the file you want to delete.
3. Press **Details** (P1 key) to view the details of a file before you continue.
4. Press **Clear** (P3 key) to clear the contents of a file.
5. Press **Delete** (P6 key) to erase the selected file from the instrument.

### 10.4.2.7 Import Memo

Imports the memo fields from a file on a microSD card to the active open file.

#### To import a memo

1. Choose **Manage > Import Memo** to open the Import page.
2. Select a file using the arrow keys or adjustment knob and press **Import** (P1 key).

## 10.5 Grid View

Grid View is a feature of the EPOCH 650 ultrasonic flaw detector data logger. With Grid View, you can observe the measurements saved in multiple IDs of the active file displayed on the live screen. This feature can be used for any file or file type, but it is most often used when conducting a thickness survey using a predefined inspection pattern. When used in a thickness survey, the grid view provides a partial or full screen grid of thickness measurements arranged by columns and rows. When you save data to an ID in the file, the saved thickness reading appears in the corresponding cell in the grid. This grid can be color coded to provide fast visibility of an area of critical thinning.

### 10.5.1 Activating Grid View

Grid View must be activated before it is visible on the screen.

#### To activate Grid View

1. Navigate to the Display Setup group menu (3/5).
2. Press **Grid Setup** (P2 key) to enter the Grid setup page.
3. Press **On** (P2 key) to turn **Grid Enable** on.

### 10.5.2 Configuring the Grid View

You use the Grid setup page to configure the grid display options.

- **Grid Size**

Controls the amount of the live screen dedicated to displaying the grid. **Half Size** splits the live display area. The top half displays the live A-scan. The bottom half displays the grid. **Full Size** uses the entire active screen area to display the grid (no A-scan is visible).

- **Display Color**

Controls the cell color coding of the live grid. Mono always applies the same text and background color to all cells in the grid.

Color applies either red, yellow or green text or background to each cell dependent on the value of the measurement.

- **Low Range Thickness**

All measurements below this value are colored red.

### — High Range Thickness

All measurements above this value are colored green.


All measurements between the **Low Range Thickness** value and the **High Range Thickness** value are colored yellow.

### To configure the grid size and color

1. In the **Grid** setup page, press NEXT to highlight the **Grid Size** field.
2. Select **Half Size** (P1 key) or **Full Size** (P2 key).
3. Press Next to move to the **Display Color** field.
4. Select **Mono** (P1 key) or **Color** (P2 key).

If you select **Color**, the **Low Range Thickness** and **High Range Thickness** fields appear.

◆ Enter a value into each field.

5. Press  to return to the live screen and display the grid.

## 10.5.3 Using the Grid

Since Grid View displays the data contained in a file, there are two ways you can view this data:

- Adding data to a file from the live screen while making measurements
- Reviewing saved data in a file.

### To use a grid in the live screen

1. Choose **File > Open** and open the file you want to use.
2. Navigate to the Display Setup group menu (3/5).
3. Press **Grid** (P3 key) to display the Grid controls (see Figure 10-25 on page 231).  
The grid controls include the arrow buttons (see “To use the arrow buttons” on page 232), **Grid** button, and **Save** button.
4. To immediately begin populating the grid with data, make a measurement and press **Save** (P7 key).
  - In an incremental file, the file ID is incremented, the data is saved to that location, and a new row in the grid is created and displayed to show the newly saved data.

- In an advanced file type, the data is saved to the current location if the ID is empty. If the ID is populated, a pop up asks if you want to overwrite the ID. If you press **No** (P2 key) the next ID is selected.

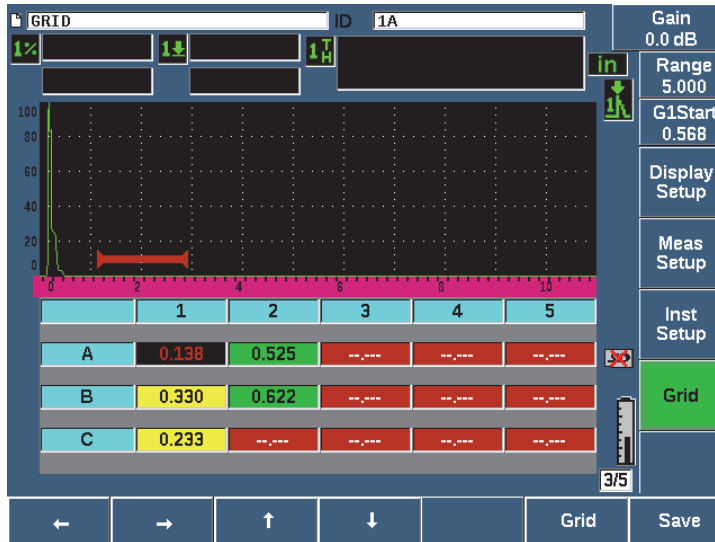


Figure 10-25 Grid controls in the live screen

### To overwrite data in a live screen

1. Use the Up and Down arrow buttons to navigate to the cell to overwrite (see “To use the arrow buttons” on page 232).
2. Make a measurement
3. Press **Save** (P7 key).  
A dialog box pops up asking if you want to overwrite the ID.
4. Select **Yes** (P1 key) to overwrite the data.

### To use a grid when viewing a saved file

1. Choose **File > Open** (group 5/5).
2. Select a file from the list and press **Contents** (P3 key).
3. Use the arrow buttons to navigate through the grid (see “To use the arrow buttons” on page 232).

4. Use **Select ID** (P2 key) to select and highlight a specific ID for viewing (see Figure 10-26 on page 232).



Figure 10-26 Grid controls in Contents screen

### To use the arrow buttons

1. Use the Left arrow button (P1 key) to move the focus to the left of the highlighted cell and change the active file ID to the new highlighted cell.
2. Use the Right arrow button (P2 key) to move the focus to the right of the highlighted cell and change the active file ID to the new highlighted cell.
3. Use the Up arrow button (P3 key) to move the focus to the cell above the highlighted cell and change the active file ID to the new highlighted cell.
4. Use the Down arrow button (P4 key) to move the focus to the cell below the highlighted cell and change the active file ID to the new highlighted cell.

---

#### NOTE

The selected cell is highlighted with a black background.

---



## 10.6 Screen Capture

The EPOCH 650 allows you to quickly capture on-screen information like the Print Screen command on a PC. The captured screen image is saved to the microSD card (included with the instrument) as a bitmap (.bmp) file type.

### To capture and save a screen image

1. Insert a microSD card.
2. Set up the EPOCH 650 to display the information that you want to capture.
3. Press 2<sup>ND</sup> F, F1 to capture the image.  
The screen freezes for a few seconds, then the unit beeps when the save is complete.
4. Remove the microSD card and insert it into a PC card reader (adaptors for this purpose are included with the instrument). The saved screen shots are titled "BMP0.bmp, BMP1.bmp, BMP2.bmp," etc., as each screen shot is saved.

## 10.7 Video Record

The video recorder allows you to record, save, delete, and play back live screen video. You can also view the video on a PC or export video to or import from other EPOCH 650 ultrasonic flaw detectors.

### 10.7.1 Activating the video recorder

Before activating the video recorder, set up the EPOCH 650 to display the events you want to record.

#### To activate the video recorder

1. Choose **Video Record > Setup** (group 5/5).
2. Press **On** (P2 key) to activate and display the video recorder controls.

### 10.7.2 Using the video recorder

Using the video recorder includes the activities associated with recording and managing video files.

## To record video

1. Press **Record** (P1 key).
2. Press **Pause** (P2 key) to pause recording and return to the previous screen.
3. Press **Flag** (P3 key) to mark individual frames for fast review during playback.

---

<b>NOTE</b>
-------------

While recording a live video, Gate and Gain adjustment are available. No other parameters can be adjusted during live recording.

---


## To save a recording

1. Press **Save** (P5 key) to display the **Create** (file) page.
2. Press **Edit** (P1 key) to enter a **Filename**.
3. Press **NEXT** to enter information in the optional fields.
4. Press **NEXT** to highlight the **Create** button, then press **Ok** (P1 key).

## To clear video from memory


- ◆ Press **Clear** (P4 key) to clear the current video recording from internal memory. The **Record** counter (above the P2 key) is reset to zero (0).

## To review a recording


1. Choose **Video Record > Video Files**.
2. Use the adjustment knob or arrow keys to select a file.
3. Press **Review** (P1 key) to playback the video in the file.
4. Press **Pause** to pause.
5. Press **Restart** to go back to the beginning.
6. Press  twice to return to the live screen and video recorder controls.

## To export a recording


1. Choose **Video Record > Video Files**.
2. Use the adjustment knob or arrow keys to select a file.
3. Press **Export** (P2 key) to export the file to the microSD card.

4. Press  to return to the live screen and video recorder controls.

### To import a recording

1. Choose **Video Record > Video Files**.
2. Use the adjustment knob or arrow keys to select a file.
3. Press **Import** (P3 key) to import the file from the microSD card.
4. Press  to return to the live screen and video recorder controls.

### To delete a recording

1. Choose **Video Record > Video Files**.
2. Use the adjustment knob or arrow keys to select a file.
3. Press **Delete** (P4 key) to delete the file.
4. Press  to return to the live screen and video recorder controls.



---

## 11. Software Features and Options

---

This chapter discusses the activation and operation of software features and options for the EPOCH 650 ultrasonic flaw detector.

### 11.1 Defining Licensed and Unlicensed Software Features

The EPOCH 650 ultrasonic flaw detector comes standard with many software features that expand the instrument's capabilities beyond standard flaw detection.

The following software features are standard components of the EPOCH 650:

- Dynamic DAC/TCG
- DGS/AVG
- AWS D1.1/D1.5

The EPOCH 650 also has several software options available. These options are not standard inclusions of the base instrument, and must be purchased and added to the unit. These options (Template Storage, API 5UE, Waveform Averaging, Interface Gate, Corrosion Module, and BEA), can be activated at the time of purchase of the instrument, or can be activated remotely after purchase of the instrument.

If a software option is not activated, you do not have access to the submenu that controls this function. Evident can provide an activation code that is entered in the instrument and allows access to the option. This allows the software to be activated without having to return the instrument to a service center.

#### To activate a software option

1. Choose **Inst Setup** (group 3/5).
2. Press **Software Options** (P4 key) to open the **Software Options** setup page (see Figure 11-1 on page 238).

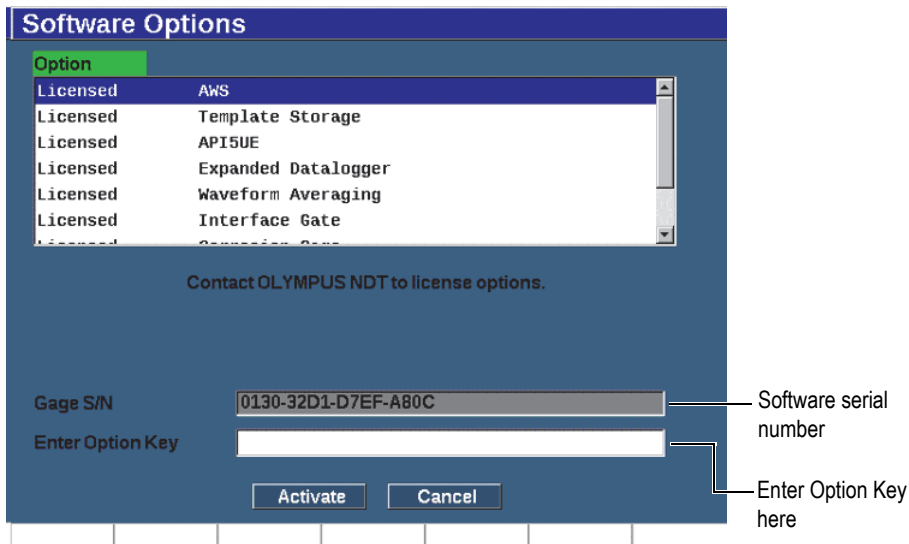


Figure 11-1 The Option key entry dialog box

3. Note the 16-character software serial number for your instrument that appears in the S/N parameter.
4. Contact Evident to purchase the software option, providing the software serial number.
5. Once Evident provides the remote activation code, open the **Software Options** setup page (**Inst Setup > Software Options**).
6. Press **Edit** (P1 key) to activate the virtual keypad.
7. Enter the activation code in the **Enter Option Key** field (see Figure 11-1 on page 238).
8. Press NEXT to select **Activate**.
9. Press **Ok** (P1 key) to activate the option and return to the live screen.

## 11.2 Dynamic DAC/TCG

A distance amplitude correction (DAC) curve is used to plot amplitude variations of signals from reflectors of the same size, but at different distances from the transducer. Normally, these reflectors produce echoes of varying amplitude due to material

attenuation and beam spread as the sound beam travels through the part. The purpose of the DAC curve is to graphically compensate for material attenuation, near field effects, beam spread, and surface roughness.

After plotting a DAC curve, reflectors of the same size as those used for creation of the curve produce echoes that peak along the curve despite different locations within the test piece. Similarly, reflectors that are smaller than those used to create the curve fall below the level, while larger reflectors exceed the curve level.

When a DAC curve is created in the EPOCH 650 ultrasonic flaw detector, the instrument also creates a time-corrected gain (TCG) setup. TCG is used to compensate for the same factors as DAC, but the presentation is different. Instead of drawing a curve across the display that follows the reference-reflector peaks downward as sound is attenuated, the TCG setup amplifies the gain as a function of time (distance) to bring the reference-reflectors to the same screen height (80 % FSH).

The EPOCH 650 DAC/TCG feature allows you to quickly and easily toggle between DAC and TCG views, giving freedom to use both techniques during a single inspection. When you switch from DAC to TCG view, the DAC curves are displayed as TCG lines across the screen. The time-varied gain effectively amplifies the signals across the time base to make the DAC curves appear as straight lines across the screen.

You can customize DAC/TCG setups to your unique application requirements using the DAC/TCG software feature for the EPOCH 650. The DAC/TCG feature incorporates several DAC/TCG modes that adhere to ASME, ASME III, and JIS sizing codes. The software offers direct control of gain, range, zero offset, and delay, as well as scanning gain and transfer correction. In addition, the DAC/TCG option provides DAC warning curves that can be customized.

In the live A-scan mode, the **DAC/TCG** menu contains the various setup and adjustment parameters. These parameters provide access to several important functions that control DAC/TCG setup and operation.

In the following sections, all DAC/TCG modes are covered. The DAC/TCG setup procedure is the same for all modes. The setup is covered in detail in the ASME/ASME-III section to follow. Any differences in the procedure to set up other DAC/TCG modes are discussed in the pertinent section for that particular mode.

## 11.2.1 Feature Activation and Reference Correct

Before any options associated with DAC/TCG are activated, the EPOCH 650 must be properly calibrated to the material being inspected.

## To activate the DAC/TCG feature

1. Choose **DAC/TCG** (group 4/5).
2. Press **Setup** (P7 key) to display the **DAC/TCG** setup page (see Figure 11-2 on page 240).
3. Press one of the parameter keys (P2 –P6) to select a **DAC/TCG Mode**.

You can also apply the **Ref Correct** (reference correction) option to the digital analysis of the live A-scan and DAC/TCG mode. The reference correction feature, when activated, allows full gain manipulation of either the live echo peaks or the DAC curve while providing the % amplitude or dB comparison of the actual peak-to-curve ratio. In this way, you can use scanning gain while maintaining an accurate measurement reading of the ratio of the gated peak to the DAC curve for sizing purposes. The gated echo amplitude is corrected back to the reference gain level for amplitude evaluation compared to the DAC curve.


4. If applicable, set **Ref Correct** to **On**.
5. Select an optional **Curve Type** (Standard, ASME-3, JIS, and CUSTOM modes), and **No of Curves**. (Select to allow or deactivate a 20–80% DAC view.)
6. Press  to return to the live A-scan screen and begin DAC/TCG setup.



Figure 11-2 The DAC/TCG setup page



## To deactivate the DAC/TCG feature

1. Choose **DAC/TCG > Setup**.
2. Select **Off** (P1 key).

## 11.2.2 Standard/ASME III DAC/TCG

The Standard DAC mode is a single DAC curve drawn from peak-to-peak on reference-reflectors. The ASME III (or ASME-3) mode draws three DAC curves: one main curve from peak-to-peak on the reference-reflectors and two warning curves at  $-6$  dB and  $-14$  dB compared to the main curve.

### To set up ASME-3 DAC mode


1. Choose either **Standard** or **ASME-3** on the **DAC/TCG** setup page.
2. Press  to return to the live A-scan screen.
3. Set the range so the first reflector of the DAC curve is toward the left side of the screen (see Figure 11-3 on page 241).



Figure 11-3 First DAC setup step

## To build a DAC curve

1. Move the probe to the first echo.
2. Press **G1 Start** (P5 key) and center gate 1 over the echo.
3. Press **Add** (P1 key).
4. Press 2<sup>ND</sup> F, (AUTO XX%) to activate AUTO 80 % for the indication.  
You can press **Delete** (P2 key) to delete a point that is incorrectly acquired.
5. Move the probe to the next echo and center gate 1 over the echo.  
You can adjust the RANGE and DELAY while detecting the echo. You can also go to the Trig menu item and adjust the **Angle**, **Thick**, and **CSC** parameters.  
Once a point is captured, the peak amplitude of that point is marked using a “x” symbol. Figure 11-4 on page 242 shows a partially completed DAC curve.

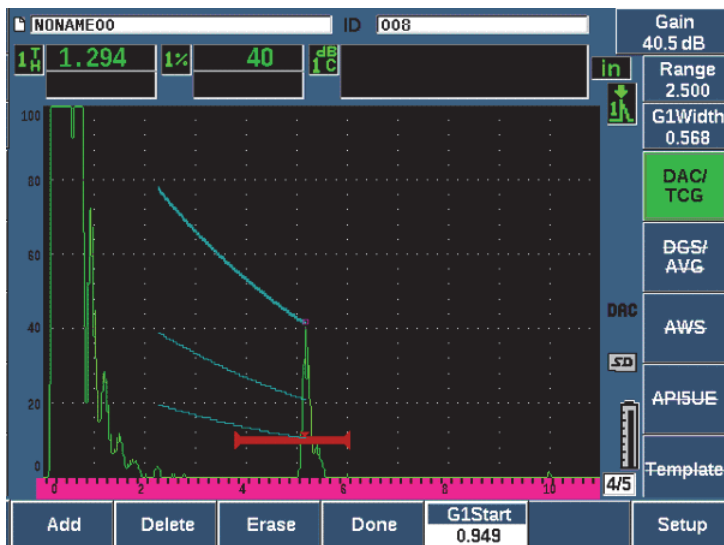


Figure 11-4 DAC Setup one point

6. Press 2<sup>ND</sup> F, (AUTO XX%).
7. Repeat capturing until a curve is built (See Figure 11-5 on page 243.)
8. Press **Done** (P3 key).



**Figure 11-5 Partial DAC curve with each echo set to 80 % FSH**

In the example above (Figure 11-5 on page 243), the instrument has drawn a DAC curve with three levels from the first point to the second. You have used the AUTO 80 % function to bring the second point to 80 % full-screen height. This assures that the point is captured accurately because amplitude resolution is better at greater echo heights. This also pushes the first captured echo over 110 % FSH so the main DAC curve and the  $-6$  dB warning curve extend downward to the second point from off-screen.

While acquiring DAC points, you have three other choices besides **Add**:

- **Delete**  
Deletes the most recently captured DAC point.
- **Erase**  
Deletes all captured DAC points (the entire curve).
- **Done**  
Completes curve acquisition and switches to inspection mode.

TIP

If you need to continue capturing points, you can increase the instrument range or increase the display delay to view echoes further out in time.

Once the correct number of points have been captured, choose **DAC/TCG > Done** to complete the DAC curve and switch to the DAC inspection mode.



Figure 11-6 The completed DAC curve

Once the DAC curve is complete and the instrument is in inspection mode, the instrument provides a new set of parameters:

- **DAC Gain**  
This adjustment allows you to manipulate the screen height/gain of both the DAC/TCG curve as well as the echoes on screen. This allows for amplitude-to-curve comparison at code compliant screen levels across the time base.
- **View**  
This parameter allows you to toggle between the DAC curve acquired and the corresponding TCG setup based on the DAC curve information.

- **Next DAC**  
This parameter cycles through the available DAC curves (if more than one is available) for amplitude comparison with on-screen echoes.
- **Gain Step**  
This parameter controls the steps by which **Curve Gain** is adjusted. Possible steps are 0.1, 1.0, 2.0, 3.0, 6.0, 12.0 dB.
- **G1Start**  
The start position of Gate 1 is also adjustable through the DAC menu as well as by pressing the GATES key.
- **Edit**  
This parameter allows you to return to DAC acquisition mode, providing access to the Add, Delete, Erase, and Done functions. (Edit is not available in TCG view.)



Figure 11-7 Completed DAC curves in TCG view mode

While DAC/TCG is active, you have full control of the **Range**, **Delay**, and **Zoom** settings. With this you can focus on areas of interest within the DAC setup. Figure 11-8 on page 246 shows a reduced range with delay.

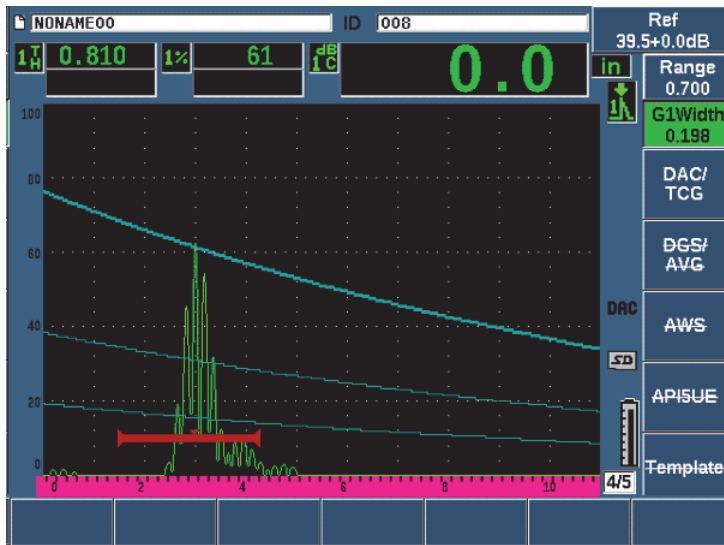


Figure 11-8 A small range DAC

## 11.2.3 Gain Adjustment Options

The EPOCH 650 ultrasonic flaw detector DAC/TCG software features three separate types of gain adjustment for each DAC/TCG setup. These gain adjustments allow for better inspection precision, easy manipulation of curves and live peak information, and transfer correction.

### 11.2.3.1 Scanning Gain

In order to quickly find and identify potential defects, it is commonly required by code to increase the gain (scanning gain) on the EPOCH 650 from the reference (calibration) gain for scanning purposes. However, once a potential defect is identified, this gain is usually removed to view the reflector at **Ref** gain level, set at calibration. The DAC/TCG software is fully capable of adding temporary scanning gain for inspection purposes. This scanning gain only affects the live A-scan and does not adjust the level of the DAC curve(s) set up on screen.

#### To add temporary scanning gain

1. Press dB.

2. Adjust the gain in either coarse or fine increments, or use the **+6 dB** and **-6 dB** keys (P4 and P5 keys) to increase or decrease scanning gain.
3. Press **dB** to access the **Gain** menu.
4. Press **Scan dB** (P2 key) to toggle between the base (reference) gain and the adjusted scanning gain.
5. Choose **dB > Off** to turn scanning gain off completely.

Figure 11-9 on page 247 shows a Standard DAC setup with 3 dB of scanning gain added.



**Figure 11-9 Standard DAC with 3 dB scanning gain**

When reference correction is active, the digital comparison between a captured reflector and the DAC curve is accurate even with the scanning gain applied to the inspection provided that the gated echo is not saturated. Figure 11-10 on page 248 shows the same setup as above but with **Reference Correction** active. Notice that the scanning gain has been removed from the dB-to-curve measurement in location 5. The instrument compares the echo height to the DAC curve, compensates for the added scanning gain, and reports the true-amplitude comparison.

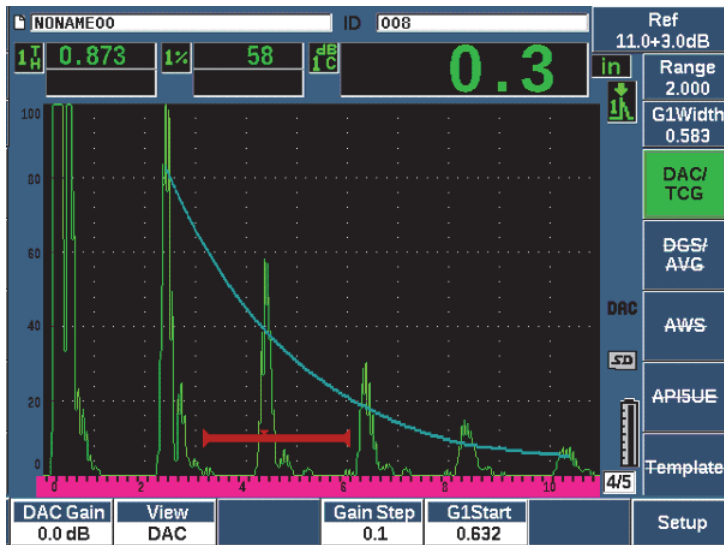


Figure 11-10 DAC with 3 dB scan gain - reference correction active

### 11.2.3.2 Curve Adjustment Gain (DAC Gain or TCG Gain)

The overall gain level of the entire DAC curve and TCG line setup can be adjusted higher or lower from the Reference Gain. Most inspection codes do not permit reflectors to be sized below 20 % FSH. Therefore, to inspect beyond a certain depth/sound path time within a part, it is necessary to raise the gain of both the live A-scan and the DAC curve to continue the inspection. This is accomplished on the EPOCH 650 using the curve gain (DAC curve adjustment gain).

#### To adjust the curve gain

1. Choose **DAC/TCG > Gain Step**, and then use the Up and Down arrow keys or the adjustment knob to choose the desired increment of the gain adjustment.
2. Press **DAC Gain** (P1 key), and then adjust the curve gain by the selected increment either positive or negative.

Figure 11-11 on page 249 shows a DAC setup with DAC gain in use to provide accurate echo amplitude measurement by placing the echo close to 80 % FSH.



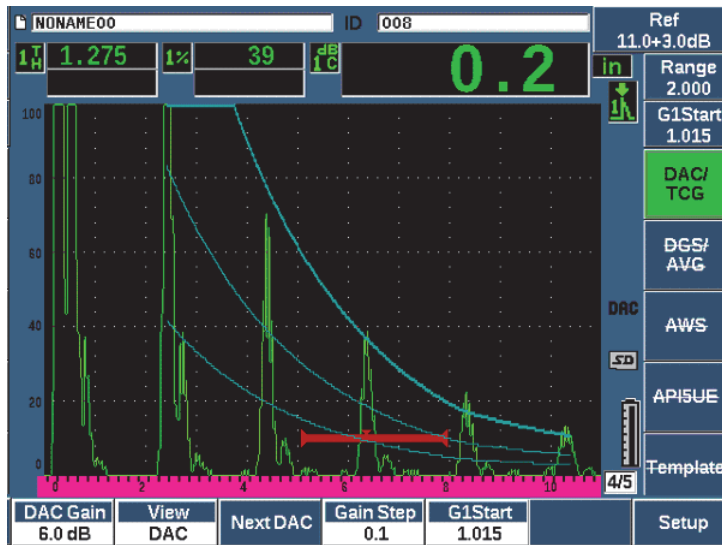


Figure 11-11 DAC curves with adjusted gain

### 11.2.3.3 Transfer Correction

Transfer Correction is an adjustment in the reference gain setting during calibration of the instrument, and is typically added when the surface conditions between a calibration block and test piece are different. The coupling conditions on the test surface can often cause signal loss after calibrating a DAC curve, which results in inaccurate comparisons of the test reflectors with the calibrated DAC curve. The EPOCH 650 can be easily adjusted for this potential difference by adding transfer correction to the calibrated base gain after completing the DAC curve setup.

#### To add transfer correction to a completed DAC curve

1. Choose **Basic**.
2. Press **dB**.
3. Use the Up and Down arrow keys or the adjustment knob to bring the scanning gain to the desired level for transfer correction.
4. Press **Add** (P2 key) to add the scanning gain to the base gain and to apply the transfer correction.

## 11.2.4 JIS DAC

The Japanese Industrial Standard (JIS) DAC mode meets the requirements of JIS Z3060. The JIS DAC curve setup is identical to the standard DAC/TCG setup. However, any of the six curves can be used to trip the alarm when in the JIS DAC mode. Additionally, you can set the alarm to positive or negative.


### To select the curve to be used as the alarm reference level

1. Activate the JIS DAC and then choose **DAC/TCG > Next DAC**.  
The selected curve appears as a double thickness line.
2. Activate an alarm and set it to either a positive or negative threshold detection.

## 11.2.5 Custom DAC Curves

The DAC/TCG software option for the EPOCH 650 ultrasonic flaw detector features a DAC curve setup that allows you to define up to six additional reference curves from the primary curve at varying levels from -24 dB to +24 dB. The Custom DAC Curves option is ideal for unique sizing inspections and procedure development. Custom DAC Curves also allow the option of either a straight-line connection or a curved, polynomial connection of each point on the DAC curve to meet various international or customer-specific requirements.

### To activate and set up the customized curves

1. Open the **DAC/TCG** setup page by choosing **DAC/TCG > Setup**.
2. Press **Custom** (P5 key) to set the **DAC/TCG Mode** to custom.
3. Select a **Curve Type** of **Curve** or **Straight** (polynomial or straight-line segments).
4. Select the **No Of Curves** to be used in addition to the main curve (see Figure 11-12 on page 251).
5. For each warning curve, choose **Curve <1-6> dB**, and set the value compared to the main curve.
6. Press  to return to the live screen to begin capturing DAC points.

DAC/TVG	
DAC/TVG Mode	Custom
Ref Correct	Off
Curve Type	Curve
No of Curves	6
Curve 1 dB	-24 dB
Curve 2 dB	-12 dB
Curve 3 dB	- 6 dB
Curve 4 dB	+ 0 dB
Curve 5 dB	+ 6 dB
Curve 6 dB	+12 dB

**Figure 11-12 Custom DAC setup**

The custom DAC setup and functionality are the same as the Standard and ASME III discussed earlier in this section. Figure 11-13 on page 252 shows a completed custom DAC setup.

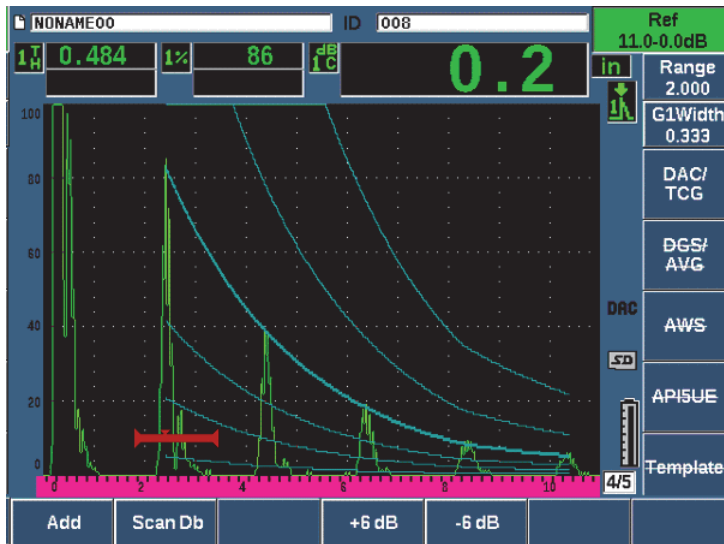


Figure 11-13 Completed custom DAC

Once the custom DAC curve points have been captured and completed, you have full capability to toggle between DAC and TCG views, to manipulate **Range**, **Delay**, **CAL Zero**, and **Angle**, and also to add necessary scanning gain, curve gain adjustment or transfer correction. The TCG view of any custom DAC curve includes the user-defined reference curves as well as the primary DAC curve. Custom DAC curve also incorporates the reference correction functionality, if desired.

### 11.3 DGS/AVG

The Onboard DGS/AVG option in the EPOCH 650 ultrasonic flaw detector permits complete DGS/AVG setups to be performed on the instrument. With the DGS/AVG method, you can size defects based upon a calculated DGS/AVG curve for a given transducer, material, and reflector size. This method requires that you only have one reference-reflector in order to create a DGS curve for flaw sizing. This is much different than the DAC or TCG method which requires that you have representative defects at various depths within a part in order to create a curve for flaw sizing.

To setup DGS/AVG curves on the instrument very quickly, Evident has developed a transducer library that is stored in the instrument's memory. This library contains the entire Atlas Series European specification conventional transducers as well as several other transducers that are commonly used by inspectors. The library includes five categories:

- **Straight Beam** contact (includes protected face)
- **Angle Beam** transducers
- **Dual Probe** transducers
- **Custom Straight** contact
- **Custom Angle** beam

All required data for building DGS/AVG curves is stored in instrument memory for each transducer in the library. If you want to use a probe that is not in the default library, you can enter the required transducer characteristics in the GageView Pro computer interface program and download them to the EPOCH 650. Probes that are downloaded to the instrument appear in the custom transducers section of the transducer library.

The onboard DGS/AVG option provides you with rapid setup times and easy flaw-size evaluation. This software option has been designed to meet the ISO 16811:2014 requirements. It is extremely important that you be familiar with this specification and others, and be qualified according to local standards to properly use this instrument function. Since the curves used for defect sizing are calculated based upon many variables, a proper instrument setup is required for accurate results.

### 11.3.1 Option Activation and Setup

Before activation of the DGS/AVG option, the instrument must be properly calibrated to the material being inspected (see "Calibration" on page 155).

#### To activate the DGS/AVG option

1. Choose **DGS/AVG > Setup** to display the **AVG** setup page (see Figure 11-14 on page 254).

DGS/AVG	
DGS/AVG	On
Probe Type	Straight Beam
Probe Name	CN4R-10
Reflector Type	Backwall
Delta VT	+0.0 dB
Reg Level	0.050 IN
Warning Level 1	-6.0 dB
Warning Level 2	+6.0 dB
Warning Level 3	+12.0 dB
ACV Specimen	0.0 dB/IN
ACV Cal Block	0.0 dB/IN
Off	On

Figure 11-14 DGS/AVG setup page

The **DGS/AVG** setup page allows you to define the exact probe being used for the inspection, and to set up the DGS/AVG curve to be drawn. There are several adjustments that can be made from this setup page:

— **DGS/AVG**

Activate/Deactivate the DGS/AVG function

— **Probe Type**

Selects the type of probe to be used (Straight Beam, Angle Beam, or Dual Probe).

— **Probe Name**

Selects the actual probe to be used.

— **Reflector Type**

Defines the type of reflector to be used to acquire a reference indication to build the DGS/AVG curve. For straight beam and dual probes, the available reflectors are:

- Back wall
- Side-drilled hole (SDH)
- Flat-bottom hole (FBH)

For angle beam probes, the available reflectors are:

- Side-drilled hole (SDH)
- K1-IIW block arc
- K2-DSC block
- Flat-bottom hole (FBH)

– **Reflector Dia.**

Used for angle beam inspections only. This allows you to define the diameter of the flat-bottom hole (FBH) or side-drilled hole (SDH) used as a reference-reflector. This size is required to properly position the DGS/AVG curve.

– **DeltaVK**

Used for angle beam inspections with reference-reflector K1-IIW or K2-DSC blocks only. This correction value for the angle beam transducer can be found listed on the DGS/AVG diagram for the selected transducer.

– **DeltaVT**

Transfer correction value, used to compensate in amplitude differences as a result of coupling variation (surface condition) from the calibration block to the test piece. EN 583-2:2001 provides methods for calculating transfer correction.

– **Reg. Level**

The height of the main DGS/AVG curve. The curve represents the amplitude from a flat-bottom hole with a diameter of the registration level at different depths. This is usually equal to the critical flaw size for the application.

– **Warning Levels**

These are the positions of up to three secondary DGS/AVG “warning” curves compared to the position of the main DGS/AVG curve. If any of these values are set to zero, the warning curve is turned off.

– **ACV Specimen**

This is the attenuation value in dB/m for the test piece (specimen). In some cases, it is necessary to calculate the relative attenuation within the test piece and enter the value here.

– **ACV Cal Block**

This is the attenuation value in dB/m for the calibration block. In some cases, it is necessary to calculate the relative attenuation within the calibration block and enter the value here.

– **X Value**


Used for angle beam inspections only. This is the length of the transducer wedge from the BIP to the front of the wedge, and is used to remove the wedge length from the surface distance measurements.

---

<b>NOTE</b>
-------------

You must be aware of when it is necessary to apply values to **ACV Specimen** and **ACV Cal Block**. These values affect the shape of the DGS/AVG curve and, therefore, affect the accuracy of defect sizing. A suggested method for the measurement of relative attenuation can be found later in this manual.

---

2. Once you have completed the selections in the DGS/AVG setup page, press  to return the live A-scan display.

### To complete the DGS/AVG curve setup

1. Couple the transducer to the calibration block and obtain a reflection from the selected reference-reflector.
2. Press GATES to gate the reference indication.
3. Press 2<sup>ND</sup> F, (AUTO XX%) to bring the reference-reflector to 80 % FSH.
4. Press **DGS/AVG > Ref** to capture the reference-reflector and build the DGS/AVG curve.





**Figure 11-15 Reference-reflector before capture**

After capturing the reference-reflector, the EPOCH 650 automatically calculates the DGS/AVG curve(s) and displays them at the correct registration level amplitude on the screen (see Figure 11-16 on page 258).



Figure 11-16 DGS/AVG curves on screen

### 11.3.2 Curve Adjustment Options

Once a DGS/AVG curve has been calculated on the EPOCH 650, you can make adjustments to that curve during an inspection. These adjustments include gain adjustments allowing proper defect scanning and code-compliant defect sizing, as well as reference-reflector adjustments.

### 11.3.3 Transfer Correction

Transfer correction is an adjustment in the reference gain setting during calibration of the instrument. It is typically added when the surface conditions between a calibration block and test piece are different. The coupling conditions on the test surface can often cause signal loss after calibrating a DGS/AVG curve, which results in inaccurate comparisons of the test reflectors with the calibrated DGS/AVG curve. The EPOCH 650 allows you to adjust for this difference by adding transfer correction to the calibrated base gain after completing the DGS/AVG curve setup.

The transfer correction can be added during initial setup of the DGS/AVG curve (**DeltaVt** value), but typically this factor is unknown until after the setup is completed.

---

## To add transfer correction to a completed DGS/AVG curve

- ◆ Choose **DGS/AVG > Delta VT** to adjust the value of the transfer correction.

---

<b>NOTE</b>
-------------

When adjusting transfer correction, the curve height should remain constant, but the echo height changes.

---

## 11.3.4 DGS/AVG Curve Gain

The overall gain level of the entire DGS/AVG curve can be adjusted higher or lower from the reference gain. Most inspection codes do not permit reflectors to be sized below 20 % FSH. Therefore, to inspect beyond a certain depth/sound path time within a part, it is necessary to raise the gain of both the live A-scan and the DGS/AVG curve to continue the inspection. This is accomplished on the EPOCH 650 using DGS/AVG curve-adjustment gain.

### To adjust the DGS/AVG curve gain

1. Press dB.
2. Adjust the curve gain in either coarse or fine increments.  
The curve-gain difference is added/subtracted from the instrument base (reference) gain.

---

<b>NOTE</b>
-------------

DGS/AVG curve gain adjustment are applied to both the echo height and curve height to maintain the amplitude ratio and therefore, the sizing comparisons.

---

Figure 11-17 on page 260 shows a DGS/AVG setup with curve-gain in use to provide accurate echo-amplitude measurement by placing the echo close to 80 % FSH.



Figure 11-17 Gain curve adjusted DGS

### 11.3.5 Registration Level Adjustment

The registration level of the DGS/AVG curve defines the height of the main curve. The curve height represents the amplitude from a flat-bottom hole with a diameter of the registration level at different depths. This is usually equal to the critical flaw size for the application. The EPOCH 650 allows you to adjust this registration level during a live inspection.

#### NOTE

This curve-height adjustment is possible because the DGS/AVG curves are calculated based on a captured reference-reflector and mathematical probe data. This allows the EPOCH 650 to plot the attenuation curve (in steel) for a particular size reflector without having to acquire individual data points, as is required in a DAC/TCG setup. This is one of the key advantages of the DGS/AVG sizing technique over the DAC/TCG sizing technique.

## To adjust the registration level

- ◆ Choose **DGS/AVG > Reg Level** to adjust the current registration-level value.

### 11.3.6 Relative Attenuation Measurement

There are several methods for measuring the ultrasonic attenuation within a material. Often the procedure measures absolute attenuation in a material. This usually requires an immersion test setup and a time-consuming set of measurements. For the purpose of flaw sizing with the DGS/AVG method, it might be suitable in many conditions to measure relative attenuation in the test piece or calibration block as needed. This section outlines one simple method of relative attenuation measurement that is generally effective. Perhaps there are more suitable methods available. You must decide the most appropriate method to arrive at the values for ACV Specimen and ACV Cal Block based on the application and local requirements.

#### Measurements:

$\Delta Vg$  = Gain difference between two successive back-wall echoes (d and 2d)

$\Delta Ve$  = From DGS/AVG diagram. Gain difference on back wall curve from d to 2d

#### Calculations:

$$\Delta Vs = \Delta Vg - \Delta Ve \text{ [mm]}$$

Sound attenuation coefficient:

$$\alpha = \Delta Vs / 2d * 1000 \text{ [dB/m]}$$

## 11.4 AWS D1.1/D1.5 Weld Rating Software

The AWS D1.1 software feature for the EPOCH 650 ultrasonic flaw detector has been created to assist you in performing inspections covered under the American Welding Society D1.1 (or D1.5) Structural Welding code for steel. This code provides inspectors with a method to classify discontinuities found in welds using ultrasonic inspection. This code uses the following formula to develop an indication rating for a reflector found during an inspection:

$$A - B - C = D$$

where:

A = Discontinuity indication level (dB)

B = Reference indication level (dB)

C = Attenuation factor:  $2 * (\text{sound path} - 25.4 \text{ mm} [- 1 \text{ in.}])$  (dB)

D = Indication rating (dB)

The AWS D1.1 inspector must take the Indication Rating (D) that is calculated based on A, B, and C to an “Ultrasonic Acceptance – Rejection Criteria” table produced by the AWS in order to classify the severity of the discontinuity that has been located. As an inspection is performed, you are required to develop an AWS report that lists the values for all variables listed above as well as transducer information, discontinuity length and location, and your overall evaluation of the discontinuity.

For further details regarding the test equipment, methods, interpretation, and classification requirements for these inspections, refer to the AWS D1.1 Code Book.

The goal of the AWS D1.1 software feature is that of simplifying inspector tasks and lowering the overall inspection time. The EPOCH 650 does this by automatically performing required calculations. It also by permits the inspector to document discontinuities in the data logger for reporting purposes.

The EPOCH 650 can also transfer inspection data through GageView Pro to aid in report generation. This program allows an inspector to view the instrument’s setup parameters, the waveform generated by a discontinuity, the sound path and location information of the discontinuity, and all values for the AWS D1.1 formula variables.

### 11.4.1 Activating the AWS D1.1 software option


The first step in operating the EPOCH 650 ultrasonic flaw detector for AWS D1.1 inspections is to calibrate the instrument for the transducer and test conditions. For information on the angle beam calibration of the EPOCH 650, see “Calibration” on page 155, or follow the appropriate guidelines from the American Welding Society.

#### To activate the AWS software feature

1. Select **AWS > Setup**.

The **AWS** setup page appears (see Figure 11-18 on page 263).

2. Set **AWS = On**.

3. Press  to return to the live screen.
4. Set a **Ref B** value to begin AWS inspection.  
The Ref B value represents the gain level necessary to bring the echo from a reference-reflector to a user defined full-screen height (FSH).

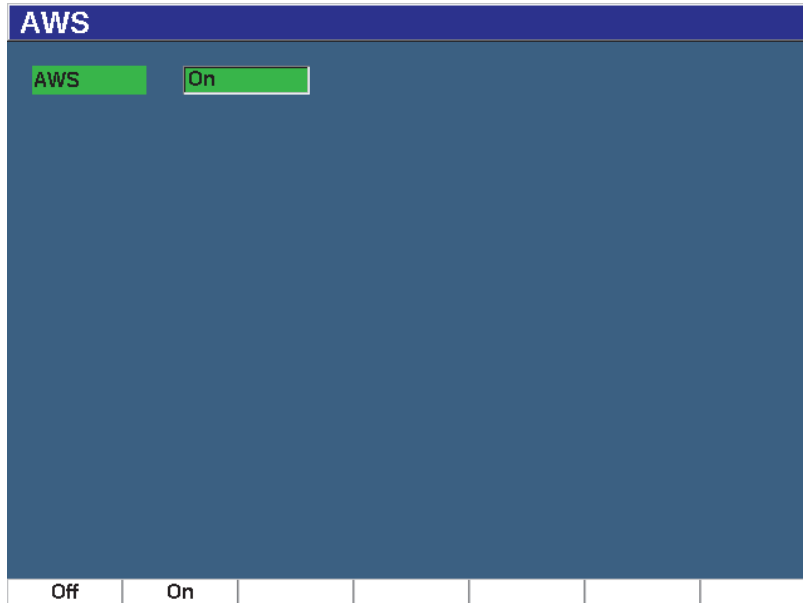


Figure 11-18 AWS setup page

## 11.4.2 Adjusting the AWS Reference Level

The EPOCH 650 ultrasonic flaw detector allows you to define the reference level to adhere to best practices and procedures. The reference-reflector is often a side-drilled hole in the calibration block used for the angle beam calibration. Other reference-reflectors can be used provided that they meet AWS requirements for these inspections.

### To adjust the reference level for echo evaluation

- ◆ In the live AWS screen, press P3, and then adjust the value to the proper reference height.

### 11.4.3 Storing the Gated Reflector

You can store the gated reflector as the Ref B value.

#### To store a Ref B value

1. Use the GATES key to gate the echo from the reference-reflector. Move the probe forward and backward to bring the echo to its maximum amplitude (peak), using Peak Memory if necessary.
2. Press 2<sup>ND</sup> F, (AUTO XX%) to bring the maximum peak of the gated echo to reference height.
3. Choose **AWS > Ref B** to store the gated reflector as the **Ref B** value and choose **YES** to confirm (see Figure 11-19 on page 264).

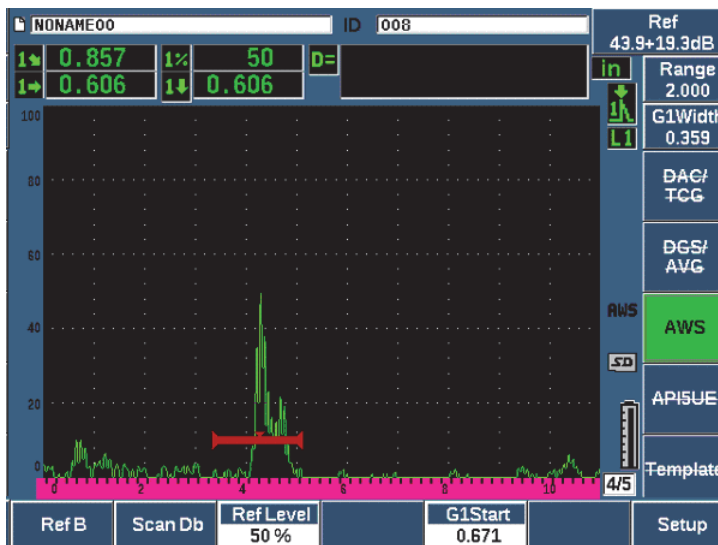


Figure 11-19 Reference B value before storage

Once the **Ref B** value is stored, the instrument displays a live D rating of any gated indication (see Figure 11-20 on page 265). This live D value, which represents the defect indication rating used with the published “AWS Acceptance - Rejection Criteria” tables to classify a potential flaw, can be viewed as a separate measurement reading in one of the five boxes. To activate and view this measurement, see “Setup Pages” on page 98.



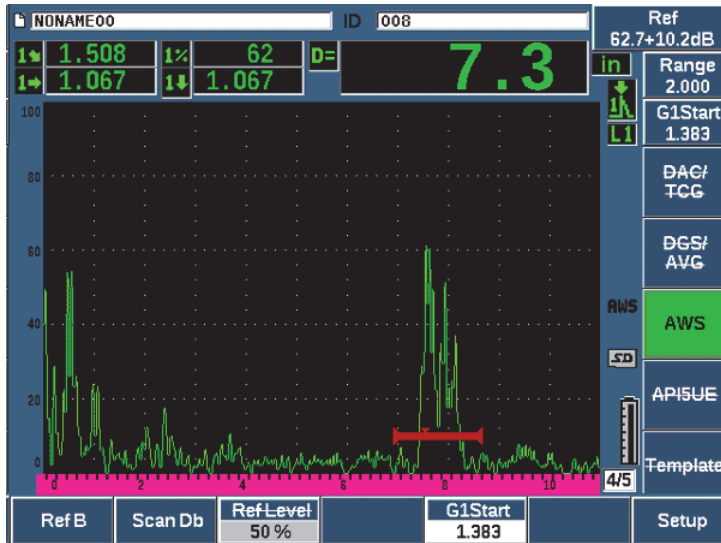


Figure 11-20 Active AWS with D rating

#### 11.4.4 Scanning Gain

AWS codes require that you enter a certain amount of scanning gain to the **Ref B** gain value. This allows you to locate flaws that might be smaller or deeper in the test piece than the reference flaw.

##### To add scanning gain

1. Use the **dB** key to adjust the scanning-gain value necessary to perform the inspection as outlined by the AWS Code.
2. Press **Scan dB** (P2 key) to toggle the scanning gain on and off as necessary.

##### NOTE

To display a D indication rating value, the gated echo must peak at an amplitude less than 110 % FSH (full screen height). You may need to turn off the scanning gain, and even make further gain adjustments to bring the echo peak on screen.

## 11.4.5 Calculating A and C Values

When a gated echo whose peak is below 100 % FSH is present, the EPOCH 650 ultrasonic flaw detector automatically calculates the A and C values necessary to provide a D indication rating value. For A, the EPOCH 650 automatically calculates the required dB value to bring the gated echo to reference height. To calculate C, the EPOCH 650 uses the data in the sound path calculator to generate an attenuation factor.

---

<b>NOTE</b>
-------------

In order for this calculation to be accurate, you must enter the correct thickness for the test piece.

---

By pressing SAVE, you can now save the data for this discontinuity in the EPOCH 650 data logger. For general data logger information, see “Data Logger” on page 199.

At the bottom of an ID saved with AWS D1.1 active, you can see the values for A, B, C, and D. This data can be viewed in the file review window.

You can also choose to see live A, B, and C values displayed in the reading measurement boxes at the top of the screen.

---

<b>NOTE</b>
-------------

While using the EPOCH 650 and the AWS D1.1 software feature, you must account for any inspection conditions that could cause variations in the displayed indication rating (D value), and properly interpret the meaning of echo indications and reported D values corresponding to these indications.

---

## 11.5 API 5UE

The API 5UE software option for the EPOCH 650 ultrasonic flaw detector is intended to assist with performing inspections in accordance with the American Petroleum Institute (API) Recommended Practice 5UE. This practice was developed specifically for OCTG manufacturers to inspect and characterize inner-diameter (ID) cracking in newly fabricated pipe. The API 5UE code uses two crack sizing methods to

characterize ID cracking: the Amplitude Comparison Technique (ACT) and the Amplitude-Distance Differential Technique (ADDT). The software developed for the EPOCH 650 aids in performing the ADDT method, which uses the following formula to determine ID crack size:

$$d_i = A_{max} \times (T_2 - T_1) \times k$$

where:

$d_i$  = imperfection size

$A_{max}$  = Maximum amplitude returned from defect area (usually 80 %)

$T_1$  = 6 dB drop point from leading peak of  $A_{max}$  (distance or time)

$T_2$  = 6 dB drop point from trailing peak of  $A_{max}$  (distance or time)

$k$  = A constant calculated from calibration to a reference notch

During an inspection using the ADDT method from the API 5UE practice, a crack that could possibly be rejected is found and inspected to find its peak amplitude. This amplitude is then set to 80 % of full screen height (FSH) and designated as  $A_{max}$ . The transducer is then moved towards the crack until the signal has dropped 6 dB, or to ½ the screen height of  $A_{max}$ . This position is noted as  $T_1$ . The transducer is then moved away from the crack until the signal has dropped 6 dB on the other side of  $A_{max}$ . This position is noted as  $T_2$ . Using these measurements, along with a  $k$  factor constant calculated during calibration, the crack size  $d_i$  is calculated and recorded.

For further details regarding this calculation, along with the calculation of the “ $k$  factor” constant, refer to API’s Recommended Practice 5UE specification.

The API 5UE software option can greatly simplify the number of operations needed to perform the ADDT test, and to greatly reduce your overall inspection time. This is accomplished using the Peak Memory function to draw a peak envelope of the crack signal and quickly capture the  $A_{max}$ ,  $T_1$ , and  $T_2$  points using a single key press. Using this collected data from the peak envelope, the EPOCH 650 performs the necessary calculation using the formula above and displays the crack height in the upper right corner of the screen (see Figure 11-21 on page 268). You can then save all relevant values of the inspected crack to the data logger for reporting purposes or transfer the values to a PC using GageView Pro.

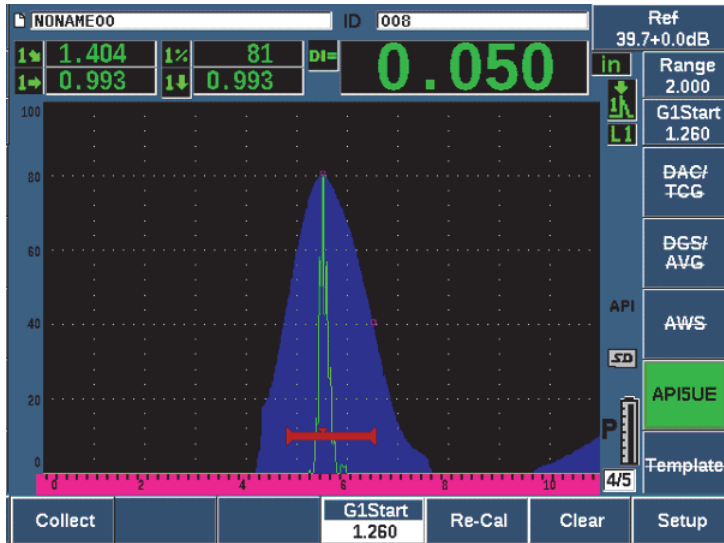



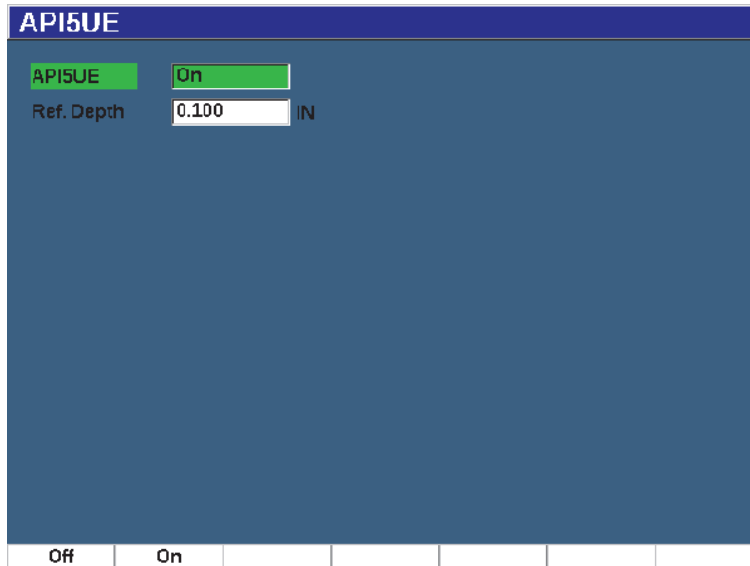
Figure 11-21 Completed API 5UE sizing

### 11.5.1 Option Activation and Setup

If the API 5UE software option has been licensed on the instrument, it can be activated at any time during standard operation.

#### To activate the API 5UE software option

1. Select **API5UE > Setup**.
2. In the **API5UE** menu, select **API5UE = On** (see Figure 11-22 on page 269).
3. Press **NEXT**, and then enter the known height of the calibration reference notch in the **Ref. Depth** box.
4. Press  to return to the live screen.



**Figure 11-22 Waveform averaging option setup**

When API 5UE is activated, the function keys on the EPOCH 650 aid the inspector in collecting calibration and inspection data. Also, the AUTO XX% feature allows you to automatically bring any captured echo to 80 % of FSH, which is particularly helpful in obtaining a precise  $A_{\max}$  reading from a reference notch.

The API 5UE code specifies that before inspection, the instrument must be calibrated using a reference notch of known depth (in certain circumstances, a through-drilled hole is desirable for calibration – see the full text of the API Recommended Practice 5UE for details concerning reference standard selection). The depth of this reference notch must be entered correctly in the activation menu for the API 5UE software option.

Before calibrating with a reference notch, the instrument should be calibrated to verify beam index point, refracted angle and distance in the inspection material. See “Calibrating to Known Sound Path Values with an Angle Beam Transducer” on page 177 and “Calibrating to Known Depth Values with an Angle Beam Transducer” on page 187 for details regarding angle beam calibration.

## 11.5.2 Envelope Mode

The simplest method for inspection of crack depth is using API 5UE in Envelope Mode. This method allows the operator to collect all pertinent data with the press of a single key and size potential defects in the most efficient manner.

### 11.5.2.1 Envelope Mode Calibration

Calibrating for API 5UE inspection in Envelope mode requires the activation of the Peak Memory function.

#### To calibrate in Envelope mode

1. Press PEAK MEM to activate the Peak Memory function.  
The letter **P** appears to the right of the live A-Scan display (see Figure 11-23 on page 271).
2. Find the reflection from the calibration notch and press 2<sup>ND</sup> F, (AUTO XX%) to bring this indication to 80 % FSH.
3. Adjust gate 1 so that it surrounds the indication.
4. Move the transducer forward and backward over the notch to draw a peak envelope of the echo dynamics of the notch.
5. Press **Collect** (P1 key) to collect the  $A_{max}$ ,  $T_1$ , and  $T_2$  data from the envelope (see Figure 11-23 on page 271).
6. Press P5 to move from calibration mode to Inspect mode.

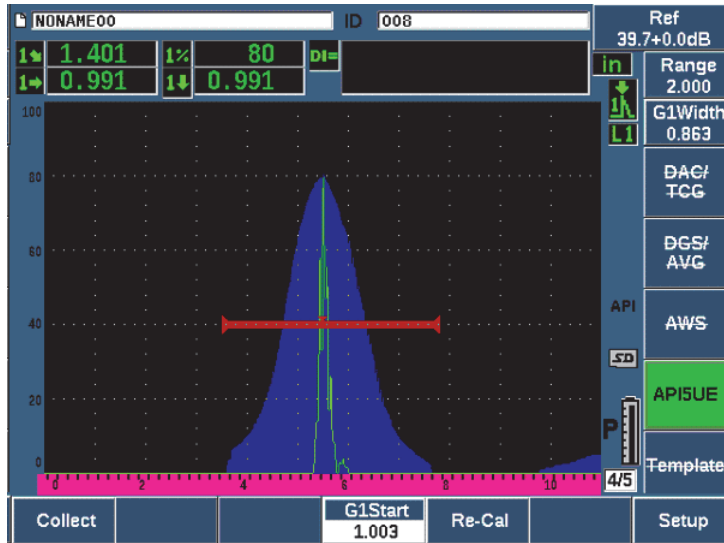


Figure 11-23 Calibration data in collect mode

### 11.5.2.2 Crack Sizing

The EPOCH 650 automatically collects  $A_{max}$ ,  $T_1$ , and  $T_2$  and calculates a “k factor” from the known reference height  $d_r$ . These three collected values ( $A_{max}$ ,  $T_1$ , and  $T_2$ ) are displayed on the screen in their respective positions using “□” marks.

Once you are satisfied with the collected calibration data, press P5 to move from Calibration mode to Inspect mode (see Figure 11-24 on page 272).



Figure 11-24 The Inspect mode

Crack sizes are displayed under the “Di” measurement (see “Reading Setup Page” on page 103).

With the Peak Memory function active, the EPOCH 650 defaults to Envelope mode for crack sizing. Use the following steps to size a crack using Envelope mode.

### To size a crack using Envelope mode

1. Press PEAK MEM to activate the Peak Memory function.
2. Find the signal from the potential defect and bring to maximum amplitude (see API’s Recommended Practice 5UE for crack scanning and inspection requirements).
3. If necessary, press 2<sup>ND</sup> F, (AUTO XX%) to bring the peak amplitude to 80 % of FSH.
4. Scan forward and backward from the peak amplitude of the crack to draw a “peak envelope” of the crack signal.
5. Adjust your screen range to adequately encompass the entire peak envelope, and then set the gate level to less than half the peak amplitude height (in % FSH).
6. Press P1 to collect  $A_{\max}$ ,  $T_1$ , and  $T_2$  from the peak envelope.



The crack size indication (di) appears at the top right corner of the live A-Scan display.

7. Find the reflection from the calibration notch and press 2<sup>ND</sup> F, (AUTO XX%) to bring this indication to 80 % FSH
8. Adjust gate 1 so that it surrounds the indication.
9. Move the transducer forward and backward over the notch to draw a peak envelope of the echo dynamics of the notch.
10. Press P1 to collect the  $A_{\max}$ ,  $T_1$ , and  $T_2$  data from the envelope.
11. Press P5 to move from calibration mode to Inspect mode.

To inspect a separate crack, or to collect new data for the same crack, press P6 to clear the current data and follow the steps above to inspect again.

### 11.5.3 Manual Mode

You can also use the Manual mode approach with the API 5UE option. This mode allows you to manually select the  $A_{\max}$ ,  $T_1$ , and  $T_2$  points from a live A-Scan to obtain a crack depth indication. With the Peak Memory function off, you can manually collect each calibration data point to calibrate the instrument for inspection.

#### 11.5.3.1 Manual Mode Calibration

##### To calibrate in Manual mode

1. Activate the API 5UE software and input a reference notch depth.
2. Find the signal from the reference notch.
3. Adjust the screen range to adequately display the full range of motion of the reference notch signal.
4. Adjust gate 1 to encompass the full range of motion of the reference notch signal, and then bring the gate to below 40 % FSH.
5. Find the reflection from the calibration notch and AUTO 80% to bring this indication to 80 % FSH.
6. Press **RefAMax** (P1) to store the  $A_{\max}$  point, and then press **RefAMax** again to confirm (see Figure 11-25 on page 274).

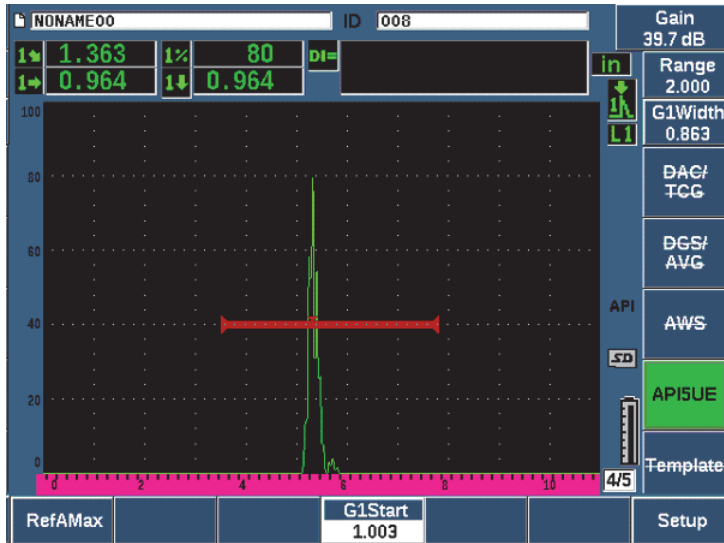


Figure 11-25 Storing the  $A_{\max}$  point

7. Move the transducer forward over the notch until the peak drops to 40 % FSH on the leading edge of the signal.
8. Press **RefT1** (P2) to collect the 6 dB drop position of the leading peak and assign this value as  $T_1$  (see Figure 11-26 on page 275).



Figure 11-26 Storing the  $T_1$  point

9. Move the transducer backward over the notch until the peak drops rises to 80 % and then falls back to 40 % FSH on the trailing edge of the signal.
10. Press **RefT2** (P3) to collect the 6 dB drop position of the trailing peak and assign this value as  $T_2$  (see Figure 11-27 on page 276).

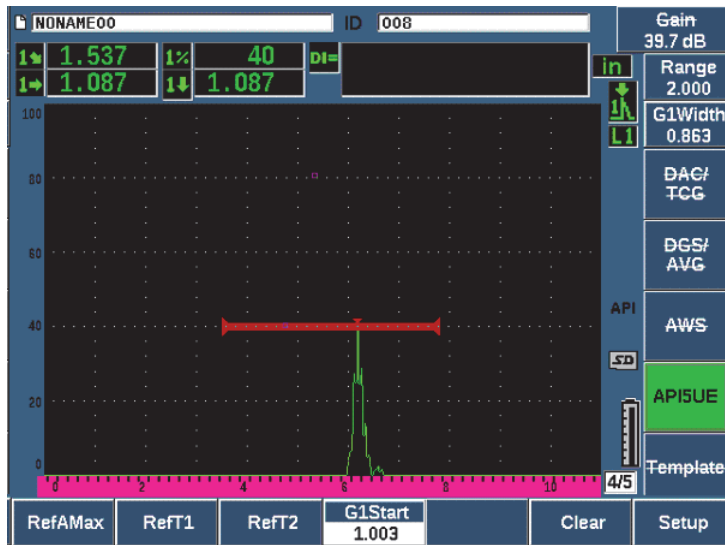


Figure 11-27 Storing the  $T_2$  point

11. Press **Clear** (P5) to complete the calibration and move to the Inspect mode.
12. If you are not satisfied with the collected points, you can overwrite a particular point using the previous parameter keys (P1, P2, or P3), or press **Clear** (P5) to clear the entire calibration and begin again.

### 11.5.3.2 Crack Sizing

Once the API 5UE software has been properly calibrated to a reference notch, use the following steps to size a crack using Manual mode.

#### To size a crack using Manual mode

1. Find the signal from the potential defect bring to maximum amplitude (see API's Recommended Practice 5UE for crack scanning and inspection requirements).
2. If necessary, use 2<sup>ND</sup> F, (AUTO XX%) to bring the peak amplitude to 80 % of FSH to ensure the peak amplitude is displayed on the screen.
3. Press **RefAMax** (P2) to assign this peak amplitude value as  $A_{max}$ . Note the value of the peak amplitude in %FSH.

4. Move the transducer towards the potential defect until the peak has dropped to  $\frac{1}{2}$  the value of  $A_{\max}$  (in % FSH) on the leading edge of the signal.
5. Press the  $T_1$  key (P2) to collect the 6dB drop position of the leading peak and assign this value as  $T_1$ .
6. Move the transducer away from the potential defect until the peak has dropped to  $\frac{1}{2}$  the value of  $A_{\max}$  (in % FSH) on the trailing edge of the signal.
7. Press the  $T_2$  key (P3) to collect the 6 dB drop position of the trailing peak and assign this value as  $T_2$ .

The crack size indication appears at the top right corner of the live A-Scan display.

8. To inspect a separate crack, or to collect new data for the same crack, press P6 to Clear the current data and follow the steps above to inspect again.

---

<b>NOTE</b>
-------------

At any time during an inspection in either Envelope mode or Manual mode, it is possible to re-calibrate the instrument. Press the **RE-CAL** function key (F5) to enter the calibration mode and follow the steps defined in “Envelope Mode Calibration” on page 270 and “Calibration” on page 155 to re-calibrate.

---

## 11.6 Waveform Averaging

The Waveform Averaging software option allows the live A-scan view to represent an average of successively acquired A-scans. Waveform averaging improves signal-to-noise ratio when static flaws are detected.


You should not use waveform averaging when dynamically scanning a test material for flaws. Doing so will average out the high peak flaw echoes with the lower amplitude clean signals that surround it, making it harder to identify specific flaw signals.

You can select the precision of the averaging, choosing between **2X**, **4X**, **8X**, **16X**, or **32X** averaging to remove spurious noise signals from the A-scan while maintaining relevant signals.

## 11.6.1 Waveform Averaging Setup

If the Waveform Averaging software option has been licensed on the instrument, it can be activated at any time during standard operation.

### To activate the Waveform Averaging software feature

1. Select **Meas Setup > Special** (group 3/5).  
The **Special** screen appears (see Figure 11-28 on page 278).
2. In the **Special** menu, select **Average**.
3. Select the level of averaging.
4. Press  to return to the live screen.

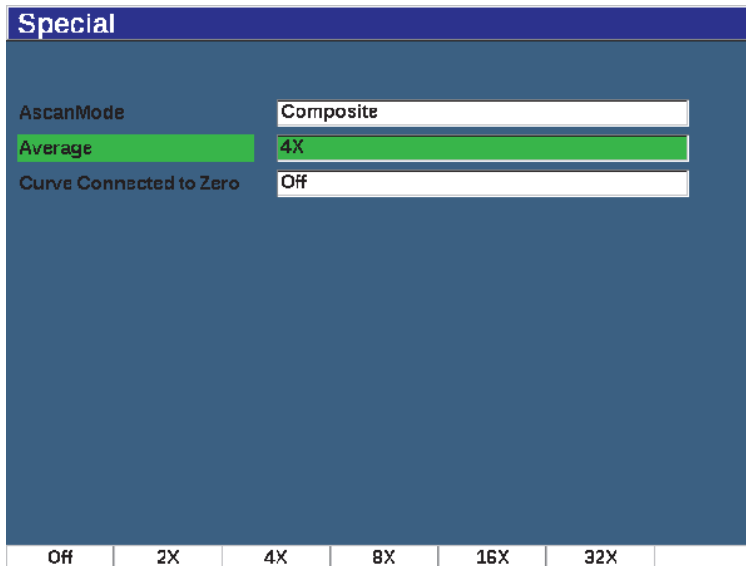



Figure 11-28 Waveform Averaging option setup

## 11.6.2 Using Waveform Averaging

When Waveform Averaging is on, the **xAv** flag () is displayed in the flag area to alert you that the option is active (see Figure 11-29 on page 279).

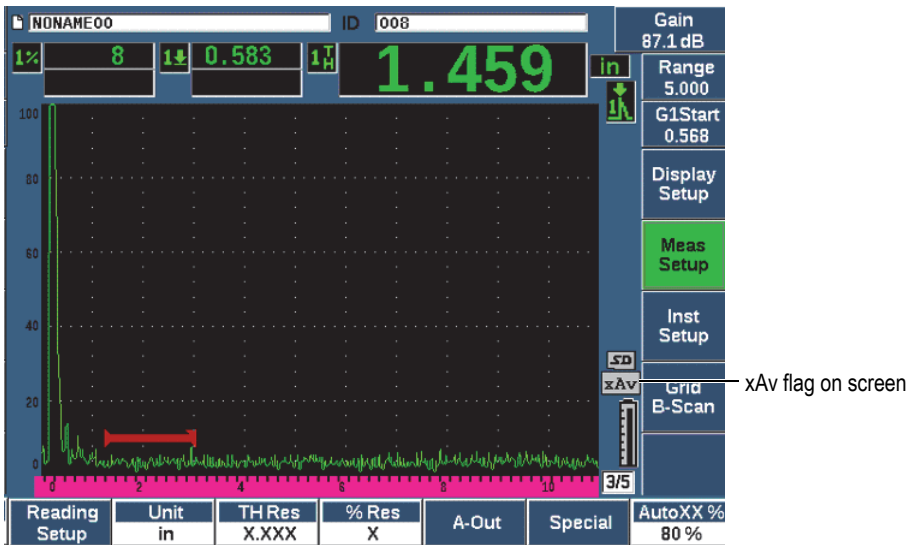



Figure 11-29 The Waveform Averaging screen

It is important to note that the effective measurement rate when using the averaging software is not equal to the PRF as it is in standard mode. The effective measurement rate when using the averaging option is equal to the total PRF divided by the averaging factor.

At higher averaging rates, the screen update rate may be less than 60 Hz (depending on the PRF value). If the screen update falls below 60 Hz (the industry standard), an icon () displays in the flag area of the screen (see Figure 11-30 on page 280).

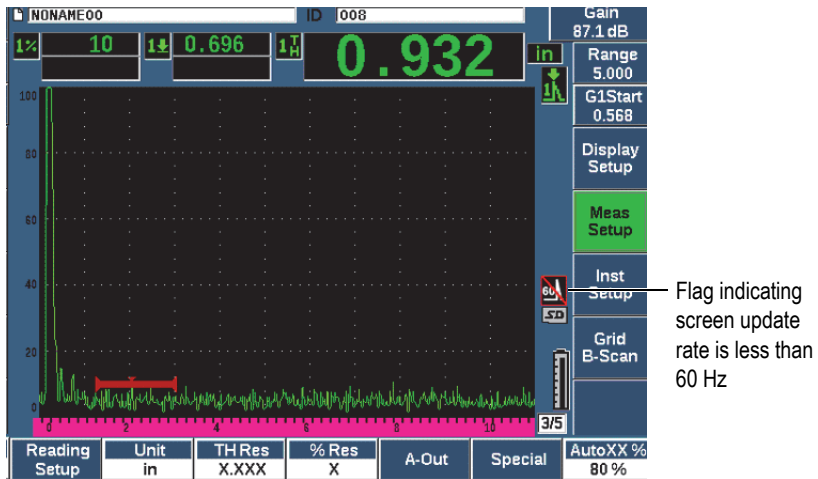


Figure 11-30 Update rate less than 60 Hz

## 11.7 Back Wall Echo Attenuator

The back wall echo attenuator (BEA) option allows you to apply an independent gain level to the A-scan defined by the gate 2 start position and width. Using the BEA, you can reduce the amplitude of the back wall echo when high gain levels are used to find small flaws.

### NOTE

The BEA feature is not compatible with the interface gate or DGS.

This option is commonly used with two specific forms of inspections:

- The first is an inspection where potential defects may not be oriented parallel to the direction of sound from the transducer. Sound will still reflect from these defects, but the reflection may be directed away from the transducer. In this situation, little or no signal is returned to the instrument for direct measurement. Generally, these defects are instead detected by monitoring for back wall signal loss or attenuation. This back wall amplitude change can be missed entirely if the back wall signal is saturated. The BEA allows you to monitor the back wall at a



lower gain setting for any signal loss, while still scanning the remainder of the test piece at a high gain level for small defects.

- In the second form of inspection (similar to the first), the BEA is used in porosity inspections. Porosity tends to scatter sound instead of returning a clear echo. In this situation, back wall amplitude may be the only way to positively differentiate porosity from material grain structure. The BEA is used to display the entire back wall signal on the screen so that it can be closely monitored.

Both inspection forms are useful when detecting very small defects.

### To activate the BEA

1. Choose the **Gate2** menu item (group 2/5).
2. Press **Status** (P7 key) then select **BEA**.

When the BEA is activated, gate 2 is on and displayed in its previous position.

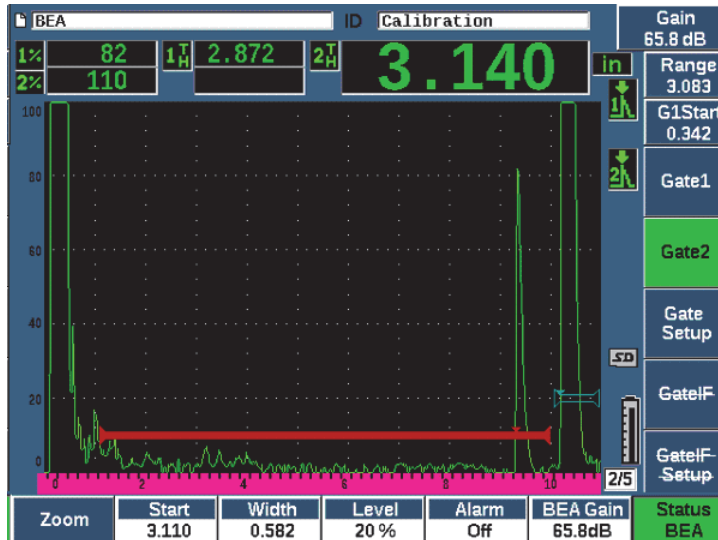


Figure 11-31 Activating the BEA

### Operating the BEA

The BEA option displays an independent back wall gain in the **BEA Gain** parameter (P6 key). This control replaces the Gate 2 Min Depth parameter while BEA is active. This gain is applied within the screen range after the start of gate 1.

Initially, this base gain level is activated to show the same gain level as the primary gain control. If the primary gain control consists of a reference gain setting and scanning dB, the base gain level of the BEA will be the sum of the reference and scanning gain levels. You can adjust the BEA gain independently to suppress the back wall echo. Measurements and alarms under gate 2 are based on the attenuated echo.

### To adjust back wall gain

1. Press **BEA Gain** (P6 key).
2. Manually adjust the gain or press 2<sup>ND</sup> F, (AUTO XX%) to automatically adjust the echo in the BEA gate to the reference height (XX%) (see Figure 11-32 on page 282).
3. Use gate 2 **Start** (P2 key), **Width** (P3 key), and **Level** (P4 key), to adjust the BEA gate position.
4. Use Zoom to expand the signal display while adjusting parameters (see “Zooming on a Gate” on page 144).

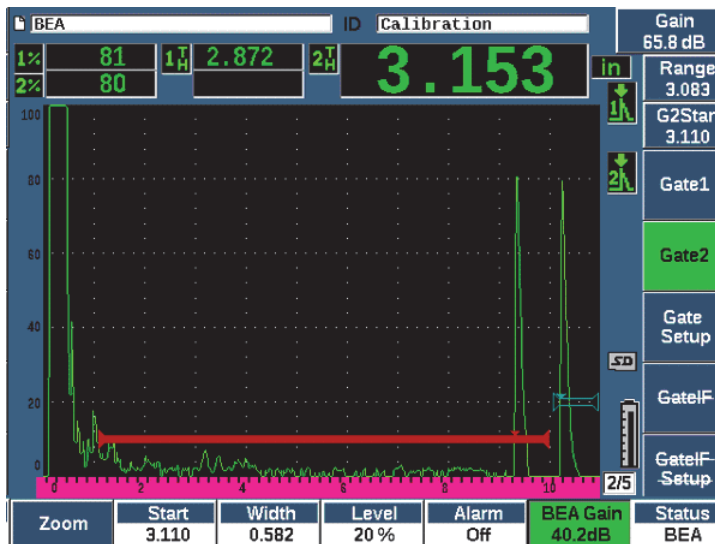


Figure 11-32 Adjusting back wall gain

When BEA is active, Gate 2 can be positioned anywhere on the visible screen range, to the extent of overlapping Gate 1.

## 11.8 Interface Gate

The EPOCH 650 interface gate (a third gate) is intended for immersion applications where the water path distance between the front surface of the test material and the transducer face is continuously changing. The application may involve an “on-line” type approach with the test material moving steadily past a stationary transducer (or vice versa). If the front surface of the test material is not uniform, a slight difference in the water path distance may result. The interface gate option tracks the position of the reflection from the interface of the water path and test piece and compensates for the variance in this reflector’s position. The interface gate is also commonly used with captive water column transducers.

### 11.8.1 Activating the Interface Gate

When the interface gate option is enabled, the **GateIF** and **GateIF Setup** submenus become available.

#### To activate the interface gate

1. Navigate to the **GateIF** menu item (group 2/5).
2. Use the adjustment knob or arrow keys to set the Status to **On**

---

<b>NOTE</b>
-------------

When the IF gate is activated, the gate tracking mode of all additional active gates is automatically set to track to the IF gate. Gate 1 and gate 2 measurements cannot be made with reference to the calibrated zero point when the IF gate is on, but gate 1 must reference the IF gate. Gate 2 (if used) can be set to track either the IF gate or gate1.

---

### 11.8.2 Adjusting the interface gate

The interface gate is adjusted from the **Gate IF** menu item.

#### To adjust the interface gate

- ◆ Use **Gate IF > Start** (P2 key), **Gate IF > Width** (P3 key), and **Gate IF > Level** (P4 key), to adjust the BEA gate position.

## 11.8.3 Setting the Material Velocity

Since the interface gate is often measuring the water path distance from the initial pulse of the instrument to the interface surface of the test material, the EPOCH 650 allows the thickness measurement from the interface gate to be made using a different material velocity than Gate 1 or Gate 2 measurements.

### To set the material velocity

1. Navigate to the **GateIF Setup** menu item (group 2/5).
2. Press **Velocity** (P7 key).
3. Use the adjustment knob or arrow keys to set the required velocity (see Figure 11-33 on page 284).

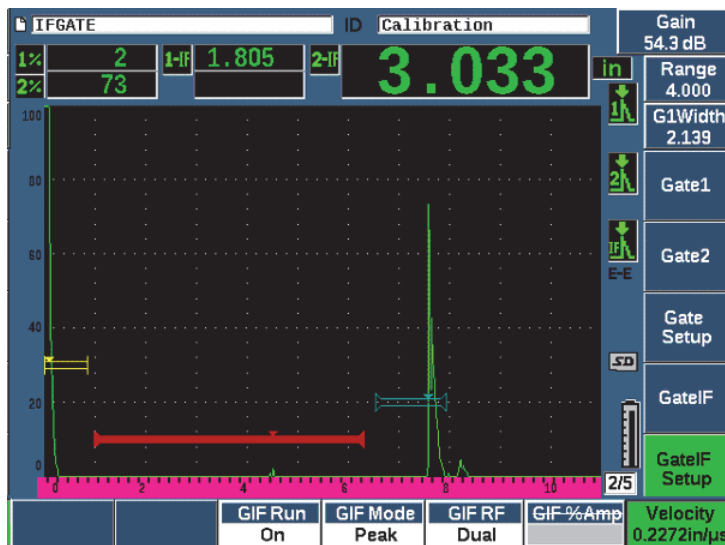


Figure 11-33 Setting the material velocity

## 11.8.4 Using Run Mode

Run mode captures and tracks the indication breaking the interface gate and holds this reflection at the left side of the display. This mode eliminates visibility to the sound path of the signal before the interface of the test material. In many cases this is a long water path and does not provide relevant inspection information.

Run mode is also useful when the sound path from the initial pulse to the reflection in the interface echo varies because of transducer or test piece movement or other factors. In run mode, any variation in the position of the echo inside the interface gate is not visible, as this echo is actively held to the left side of the display. This allows more stable visibility to the test material reflection positions regardless of interface variation.

Note that the indication being tracked by the interface gate is determined by the gate measurement mode. For instance, if the interface gate is in edge detection mode, the tracked indication is the first echo to break the interface gate threshold.

### To adjust the interface gate run mode

1. Navigate to the **GateIF Setup** menu item (group 2/5).
2. Press **GIF Run** (P3 key).
3. Use the adjustment knob or arrow keys to set the parameter to **On** (see Figure 11-34 on page 285).

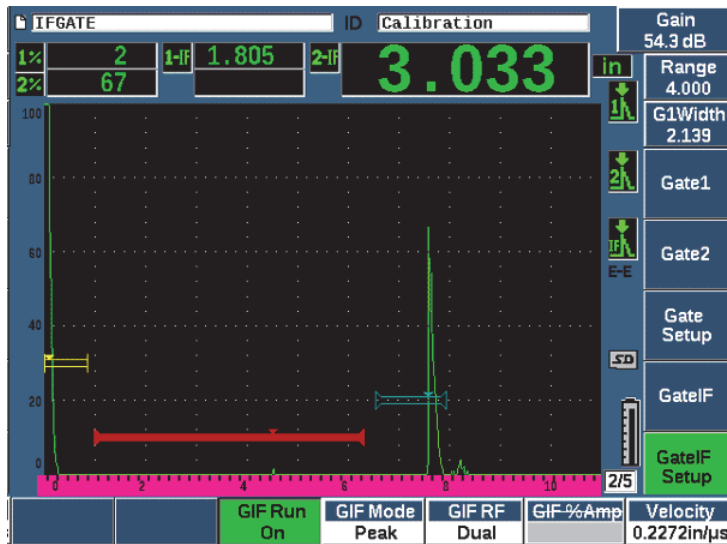


Figure 11-34 Setting the gate interface run mode

## 11.8.5 Interface Gate Compatibility

The interface gate can be used with other software features, such as TCG and Template Storage. This allows these features to operate during immersion inspections in addition to manual inspections.

You must activate the interface gate before activating any additional software feature. Once the additional feature is activated and properly set up, it will track to the position of the reflection in the interface gate.

Figure 11-35 on page 286 shows an example of the interface gate and TCG when used together. The TCG is indicated by the horizontal, purple line at the top of the A-scan display. In this example, any change in the position of the echo in the interface gate causes the entire TCG window to be shifted. As a result, dynamic amplification of defect echoes in the TCG window are consistently applied regardless of shifts in the interface echo position. For more information on TCG, see “Dynamic DAC/TCG” on page 238.



Figure 11-35 Interface gate and TCG

## 11.8.6 Gate Measurements and Alarms

The interface gate does not allow the same standard measurements as gate 1 and gate 2. The interface gate only measures the thickness of a given indication, when applicable.

Individual gate alarms can be set while the interface gate is active. The negative threshold alarm is most common when looking for interface echo drop-out. For more information about setting up gate alarms, see “Gate Alarms” on page 145.

## 11.9 Corrosion Module

The EPOCH 650 ultrasonic flaw detector Corrosion Module provides a rapid and simple solution for flaw detector users to perform basic corrosion inspections. This feature provides simplified instrument operation for corrosion applications, requiring less set up time and more efficient data collection. The Corrosion Module leverages many of the inspection features used in dedicated corrosion thickness gages while maintaining a close connection to standard flaw detector operation.

Once the appropriate preset dual transducer is selected, the Corrosion Module automatically adjusts the pulser and receiver settings to optimize the ultrasonic setup. Measurement thresholds and gain adjustments are also handled automatically, allowing immediate thickness measurements with minimal operator intervention.

### 11.9.1 Key Features

Several key features are included in the EPOCH 650 ultrasonic flaw detector Corrosion Module that vary from standard flaw detector operation.

- **Automatic Zero**  
Automatic Zero corrects for internal electronic delays, cabling delays and transducer delays to the end of the delay line. Automatic Zero calculates the zero offset of the system by measuring the time-of-flight of sound through the end of the delay material on the connected dual probe. While this measurement does not correct for couplant variation or surface conditions of the test piece, it calculates the majority of the zero offset value required for accurate material measurements before you couple the transducer to the test piece.
- **Automatic Gain Compensation**  
Automatic Gain Compensation (AGC) allows the EPOCH 650 to acquire consistent measurements. The AGC continuously optimizes the most prominent

signal (largest echo) on screen by automatically adjusting the gain level of the system. AGC adjusts this largest echo signal on screen to a predetermined height (based on the selected probe), to maintain a consistent echo height and shape.

- Zero Cross Detection Algorithm

The Corrosion Module uses a unique measurement mode called the Zero Cross detection algorithm. This measurement mode, unlike Peak, Edge, or First Peak mode, uses the first point in time when the echo of interest crosses the baseline (zero cross) to make the measurement. By using the zero cross point, the measurement is not affected by variation in amplitude, which is a major source of inaccuracy in traditional flaw detector corrosion applications. To be recognized as the “echo of interest,” an echo must be higher than a fixed screen height threshold. To ensure prominent echoes achieve this criteria, AGC is used to maintain dynamically optimized amplification of the A-scan.

- V-Path Correction

The EPOCH 650 Corrosion Module includes V-path correction for all dual probes in its standard probe library. Dual transducers are typically constructed with a small angle of incidence in both the transmit and receive crystals. This small angle is known as the “roof angle.” Because of the roof angle, sound is introduced to a test piece at a small refracted angle. Therefore, the actual depth of a given reflector is slightly smaller than the measured depth unless the measurement includes a correction for this roof angle. The angle correction is called “V-Path Correction,” and is achieved when the roof angle of a given dual transducer is known and compensated for during measurement.

## 11.9.2 Corrosion Module Screen

The EPOCH 650 ultrasonic flaw detector Corrosion Module has a modified screen layout compared to standard flaw detector mode. Also, many of the normal flaw detection functions are limited or unavailable when in the Corrosion Module (see Figure 11-36 on page 289).

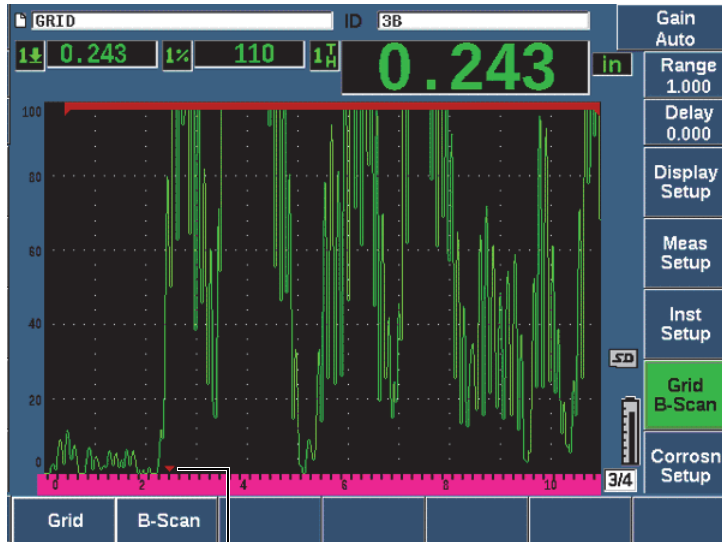
Measurement Boxes – The measurement boxes are fixed in Corrosion Module to more limited selections applicable to corrosion measurement only.

Gain Control – The Gain control is set to Auto when AGC is active

Measurement Region – The measurement region is defined by the gate at the top of the A-scan window. Gate level adjustment is not available in Corrosion Module because the measurement mode is fixed to “Zero Cross.”



Measurement Indicator – The measurement indicator is located at the bottom of the A-scan window to show more accurately where the zero cross measurement is being acquired.



Measurement indicator

**Figure 11-36 Corrosion Module screen**

A common visual tool used in Corrosion Module is the Grid View. For more information, see “Grid View” on page 229.




Figure 11-37 Corrosion Module grid view

### 11.9.3 Corrosion Module Activation and Setup

The Corrosion Module can be quickly activated and set up. When the Corrosion Module is first activated, the Transducer Setup page is displayed. The Transducer Setup page allows you to select the dual transducer you will use during your inspection. When a transducer is selected, key parameters for the selected transducer are loaded with default values. These values are shown on the right side of the Transducer Setup page.

#### To activate the Corrosion Module

1. Choose **Inst Setup**> **General**.
2. Highlight the **Corrosion Gage** row at the bottom of this menu and select **On** (P2 key).
3. Press  to finish the activation and display the **Transducer Setup** page (see Figure 11-38 on page 291).

#### To set up the dual transducer

1. Connect an appropriate dual transducer to the EPOCH 650.

- In the **Transducer Setup** menu, select the connected dual transducer from the list.

---

**IMPORTANT**

---

The proper selection of the dual transducer is critical for proper operation of the Corrosion Module.

---

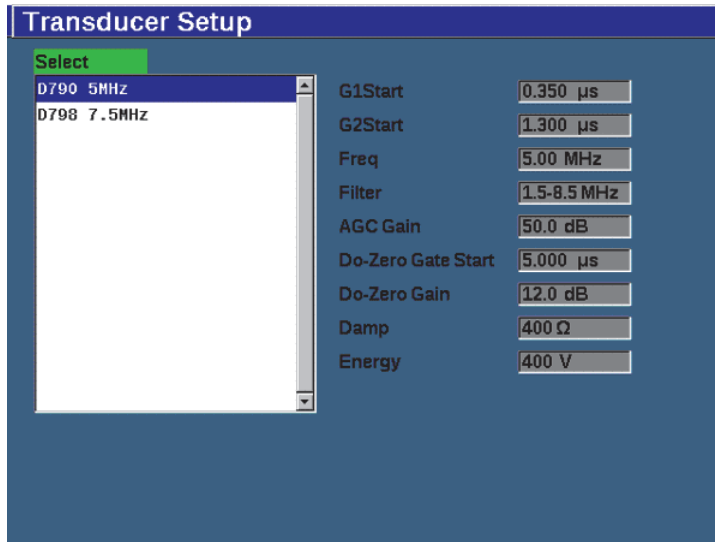



Figure 11-38 Corrosion Module transducer Setup menu

- Press  to continue.
- Follow the prompt to wipe the couplant off the probe, then press **Continue** (P1 key).

The Corrosion Module automatically measures the zero offset of the probe delay line (Do-Zero). The EPOCH 650 is now zeroed and ready to make measurements.

## 11.9.4 Basic Measurement Adjustments

The accuracy of measurements can be enhanced by performing a two-point calibration (see “Measurement calibration” on page 74), but the combination of default settings from the Transducer Setup menu and the Do-Zero function allows immediate measurements with a reasonable amount of accuracy.

Common adjustments in the basic Corrosion Module measurement mode include:

- Rectification
- Extended Blank Control
- Manual Gain Adjustment

### 11.9.4.1 Rectification

All rectification views are available in Corrosion Module, including Fullwave and RF (most common selections).

### 11.9.4.2 Extended Blank Control

Based on material and (or) transducer, the Corrosion Module detection algorithm may incorrectly trigger measurements from a signal before the first back wall. This signal can be caused by surface conditions, transducer cross talk, or other factors (see Figure 11-39 on page 293).

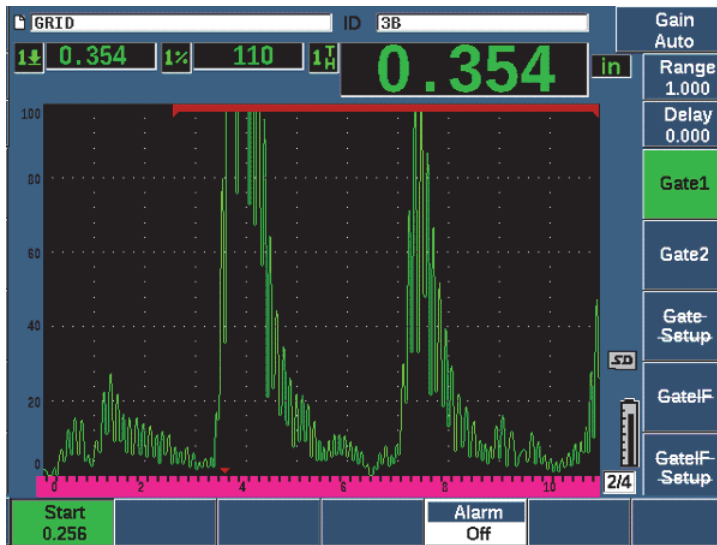


Figure 11-39 Incorrectly triggered measurement

If this situation occurs, you can adjust the start position in time of the measurement window by adjusting the start position of Gate 1.

#### To adjust the measurement window start position

- ◆ Press GATES and increase or decrease the gate 1 start position.

#### 11.9.4.3 Manual Gain Adjustment

While Automatic Gain Compensation (AGC) is recommended when measuring in the Corrosion Module, some applications may require manual adjustment of gain to achieve optimal results. Often this requirement is related to transducer sensitivity. If the transducer sensitivity is low, the default initial gain for the transducer may not be sufficient to allow measurements in AGC mode. If the transducer is overly sensitive, or the test material is highly transmissive, the default initial gain may be too high and result in amplified noise or cross talk, causing incorrect measurements.

#### To manually adjust the gain parameter

1. Choose **Corrosn Setup** > AGC (group 3/4).

- Use the knob or arrow keys to set **AGC** to **Off** (see Figure 11-40 on page 294).

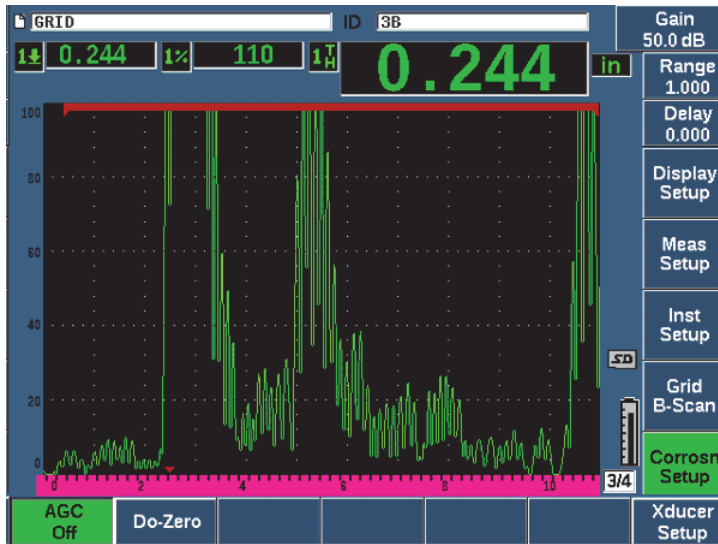


Figure 11-40 Corrosion Module AGC set to Off

- Press dB and press a parameter key (P1–P7) to set a gain range, then use the knob or arrow keys to adjust the gain value (see Figure 11-40 on page 294).

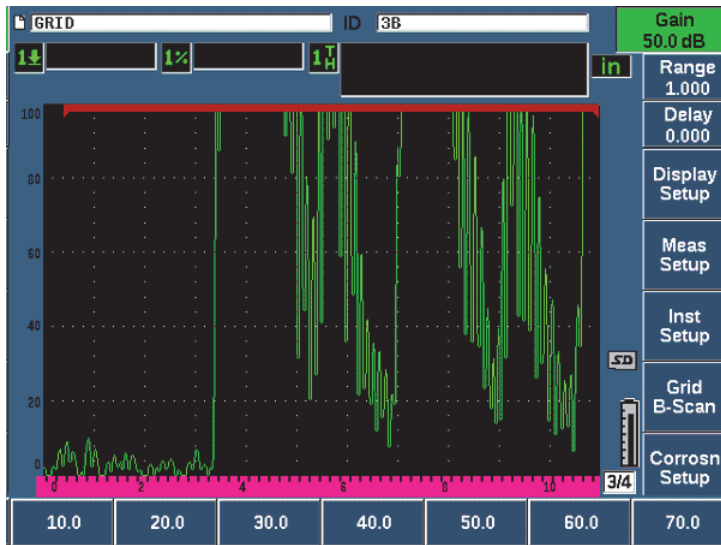


Figure 11-41 Adjusting the Corrosion Module gain value

### 11.9.5 Calibration for Additional Accuracy

For additional measurement accuracy, you can perform a two point calibration while the Corrosion Module is active. See “Calibration” on page 74 for instructions on performing a two point calibration. Remember that the calibration must be performed using an Evident dual transducer.

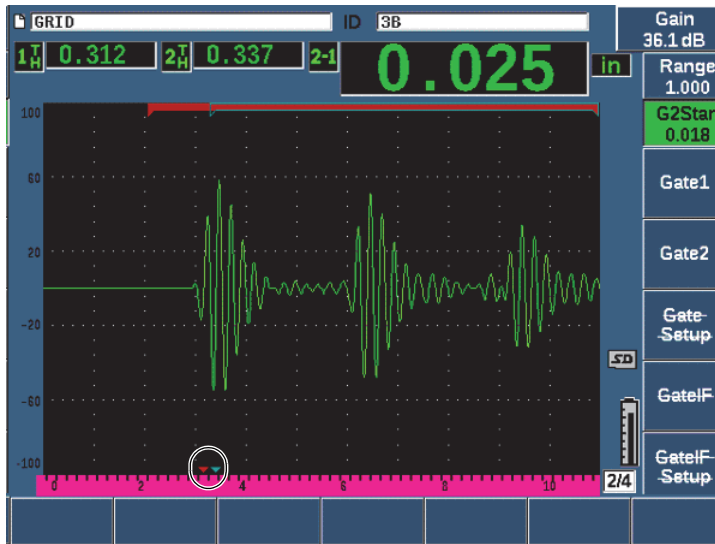
### 11.9.6 Echo-to-Echo Measurements

The Echo-to-Echo function measures the distance between an echo in Gate 2 and an echo in Gate 1. In some limited applications, you may want to measure the thickness of a material using this function. The Echo-to-Echo function is most common when measuring coated materials, as a measurement of the first back wall will include the thickness of the coating. By measuring the distance between the second successive back wall and the first, a more accurate measurement of the base material is obtained. This allows you to ignore the coating layer.

#### To perform an echo-to-echo measurement

1. Use the NEXT key to navigate to the **Gate2** menu item (group 2/4).

2. Use the knob or arrow keys to change the **Status** parameter (P7) to **On**.
3. The measurement box automatically changes to measure Gate 2 – Gate 1.
4. Choose the **Rcvr** menu item (group 1/4).
5. Use the knob or arrow keys to change the **Rect** parameter (P1) to **RF** so you can view the positive and negative amplitude values.



**Figure 11-42 Corrosion Module echo measurement**

As a result of the roof angle of dual transducers, often a shear wave is also produced in the inspection material when using a dual probe. Shear wave velocity is slower than longitudinal wave, so the shear component is displayed after the first backwall echo. If the shear wave component is significant enough to cross the measurement threshold, it can trigger a false measurement from the gate 2 region in Echo-to-Echo mode. This causes a measurement error (see Figure 11-43 on page 297).





Figure 11-43 Echo measurement error

If this situation occurs, you can adjust the start position in time of the second back wall measurement window by adjusting the start position of Gate 2.

### To adjust the measurement window start position

1. Press the **Gates** key until **G2Start** is highlighted.
2. Use the knob or arrow keys to increase the gate 2 start position until the shear component is no longer measured.

## 11.9.7 B-Scan

The B-scan feature allows you to collect a single value B-scan from measurements made in the Corrosion Module. A single value B-scan represents the side profile of a test material based on thickness or time-of-flight (TOF) measurement. This view, typically used in corrosion scanning applications, is used to verify acquired thickness measurements, and also to provide a visual reference showing areas on the part with critical thickness values.

A scanner equipped with an internal encoder mechanism can provide transducer location information (distance traveled) in addition to the thickness reading. This feature increases the functional value of the B-scan as relative location in the material is directly correlated with a thickness measurement at that location. The maximum scan rate is 30 Hz.

The B-scan has three separate operating modes:

- **Bidirectional Encoded Mode**  
This mode requires the use of a bidirectional encoder that records location information as data is collected in both forward and backward directions.
- **Unidirectional Encoded Mode**  
This mode requires the use of a bidirectional or unidirectional encoder and records location information as data is collected in either the forward or backward direction as if data is collected in one direction only.
- **Manual (Timed) Mode**  
This mode does not record location information and does not require the use of an encoder. This mode provides a continuous scan of thickness data with no correlation to its location along the scan. Readings are collected at a maximum of 30 Hz and are not related to transducer movement.

### 11.9.7.1 Activating the B-Scan

Before activating the B-scan, you should create and open an inspection file in the instrument data logger. For instructions on creating and opening an inspection file, see “Data Logger” on page 199.

#### To activate the B-scan


1. Navigate to the **B-Scan** menu item (group 3/4) shown in Figure 11-44 on page 299.
2. Choose **B-Scan** (P2 key).
3. In the **B-Scan** setup page set the value of each field (see Figure 11-45 on page 301).
4. Press  to return to the live screen.



Figure 11-44 B-scan menu item

### 11.9.7.2 B-Scan Setup Page

The B-Scan setup screen displays fields that allow you to enter or modify the following information.

- **B-scan Enable (On, Off)**  
Activates or deactivates the B-scan function.
- **Encoder Mode (Bi-Directional, Uni-Directional, Manual)**  
Sets the method of B-scan acquisition to either Bi-Directional, Uni-Directional, or Manual (timed).
- **Scan Display Size (Half Size, Full Size)**  
Selects the live screen size of the B-scan.
- **Direction (L to R, R to L)**  
Sets the live data collection direction of the B-scan as either left-to-right or right-to-left.
- **Display Color (Mono, Color)**  
Toggles the B-scan image color between **Mono** (single color) and **Color** (three color zones indicating acquired scan thickness regions).

When Display Color is set to **Color** all thickness values between the Low Range Thickness value and the High Range Thickness value are drawn using the color yellow.

— **Low Range Thickness**

Sets the thickness value below which the B-scan is drawn using the color red (Color scan only).

— **High Range Thickness**

Sets the thickness value above which the B-scan is drawn using the color green (Color scan only).

• **Encoder Resolution**

Fixed property of the connected encoder, sets the number of encoder pulses per unit of measure (encoded B-scan only).

- **Scan Resolution** (0.13 mm, 0.26 mm, 0.38 mm, 0.51 mm)[0.005 in., 0.010 in., 0.015 in., 0.020 in.]

Sets the interval of successive measurements (encoded B-scan only). The reading resolution can be changed in the following increments:

- 0.13 mm (0.005 in.) — Takes a reading every 1 pulse
- 0.26 mm (0.010 in.) — Takes a reading every 2 pulses
- 0.38 mm (0.015 in.) — Takes a reading every 3 pulses
- 0.51 mm (0.020 in.) — Takes a reading every 4 pulses, and so on.

Scan resolution is limited to increments of the encoder resolution that you are using. For example, if the encoder resolution is 7.87 pulses/mm (200 pulses/in.), then the best resolution possible is 0.127 mm (0.005 in.). Each pulse from the encoder is capable of taking readings in increments of 0.127 mm (0.005 in.).

• **Start Coordinate**

Sets the starting Distance Travelled (DT) position of the scan (encoded B-scan only).

• **Stop on LOS**

Activates or deactivates the function to stop B-scan data acquisition when a Loss of Signal (LOS) measurement occurs.

B-Scan	
B-Scan Enable	Off
Encoder Mode	Manual
Scan Display Size	Half Size
Direction	L to R
Display Color	Mono
Stop on LOS	Off
Off	On

Figure 11-45 B-Scan setup page

### 11.9.7.3 B-Scan Acquisition and Control

In the live screen, use the B-scan controls (displayed over the parameter keys) to acquire your B-scan image.

- Start (Stop)  
Use this control to start or stop the acquisition of your B-scan image

#### NOTE

In Bi-Directional or Uni-Directional Encoder Modes, acquisition of the B-scan does not begin until the attached encoder is moved. In Timed Encoder Mode, acquisition of the B-scan begins as soon as you press the Start button (P1 key).

- New Scan  
Use this control to start a new B-scan. All current B-scan data is erased.
- Setup  
Returns you to the B-scan setup screen. All current B-scan data is erased.
- Save Min

Saves the entire collected B-scan to the active file ID including one compressed A-scan representing the minimum thickness reading of the collected B-scan (excluding A-scan for LOS conditions).

- Save

Saves the entire collected B-scan to the active file ID including the last acquired compressed A-scan (excluding A-scan for LOS conditions).

During B-scan acquisition, a blue indicator appears at the bottom of the B-scan window (see Figure 11-46 on page 302). This blue arrow indicates the B-scan position associated with the minimum thickness data point (excluding LOS data).



Figure 11-46 B-scan position indicator

#### 11.9.7.4 Viewing the B-Scan in the Data Logger

Once B-scan data is saved to a file, it can be displayed in the data logger. B-scans can only be displayed in the data logger if the B-scan is active.

##### To view a B-scan image

1. Ensure that Corrosion Gage is on (see “Corrosion Module Activation and Setup” on page 290).

2. Ensure that the B-scan is active (see “Activating the B-Scan” on page 298).
3. View the **Contents** of the file ID with the saved B-scan (see “Viewing Setup and Waveform Data for Saved IDs in a File” on page 211).

A vertical cursor on the B-scan image indicates the position of the saved compressed A-scan. The vertical cursor is controlled by buttons that are displayed above the parameter keys (P4 - P7) when a B-scan file is active (see Figure 11-47 on page 303):

Left arrow (P4 key)

Moves the vertical cursor one (1) increment to the left for review of individual B-scan data points.

Right arrow (P5 key)

Moves the vertical cursor one (1) increment to the right for review of individual B-scan data points.

Left double arrow (P6 key)

Moves the vertical cursor ten (10) increments to the left for rapid review of individual B-scan data points.

Right double arrow (P7 key)

Moves the vertical cursor ten (10) increments to the right for rapid review of individual B-scan data points.



Figure 11-47 B-scan display in the Data Logger

## 11.10 Template Storage

Template storage provides a means of making a reference template of a scan, then comparing template to the live A-scan. This option can be very useful for spot weld inspection, and also for condition monitoring over time.

As all of UT testing is in some way a comparative test, template storage can be used in many different applications to compare known conditions to unknown samples.

### To activate template storage


1. Choose the **Template** menu item (group 4/5).
2. Press **Setup** (P7 key) to display the Template setup page (see Figure 11-48 on page 305).
3. Press **On** (P2 key) to turn template storage on.
4. Turn **Gain** to **On** if you want gain adjustments to be active.
5. To name the template, press **Edit** and create a name.
6. Press **Add** to add the name to the list.
7. Repeat steps 5 and 6 to add more template names.

---

<b>NOTE</b>
-------------

The first five templates names are shown above the parameter keys (P1–P5).

---

8. Press  to return to the live screen.



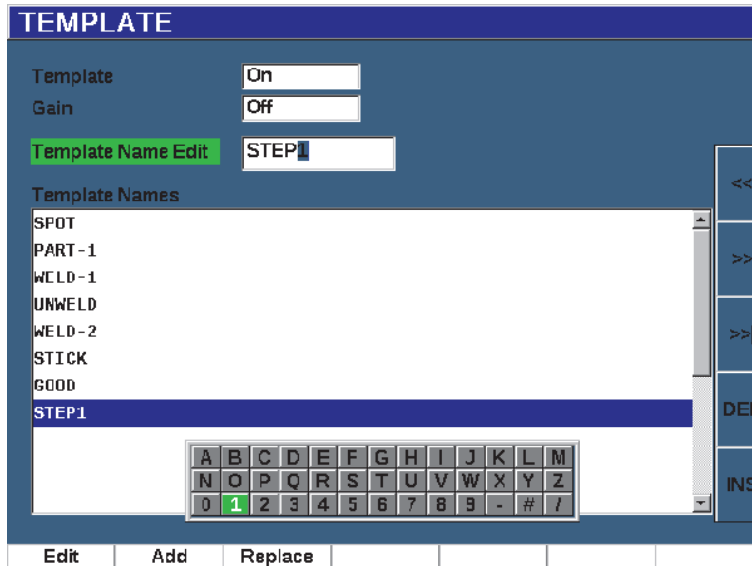



Figure 11-48 Template setup page

### To store and activate a template

- ◆ With the Template menu active, press 2<sup>ND</sup> F, then select one of the templates (P1–P5 keys) to store the template.

The template name is displayed with the symbol **-A-** below the name. This indicates that the template is stored *and* active (see Figure 11-49 on page 306).

OR

1. Press the right arrow (P6 key) to open the **Template** page.
2. Select a template name, then press **Store** (P2 key).
3. Press  to return to the live screen.

The template name is displayed with the symbol **-A-** below the name. This indicates that the template is stored *and* active (see Figure 11-49 on page 306).

Opening the Template page to activate and store a template is necessary if the template you want does not appear over any of the parameter keys. However, you cannot see the live screen until after you store a template. You may have to store again from the live screen (2<sup>ND</sup> F, (P1–P5) to get an accurate template image.

## NOTE

When a template is stored, but not active, template name is displayed with a \* symbol below the name.



Figure 11-49 -A- indicates an active template

### To display a stored template

- ◆ Press one of the parameter keys (P1–P5) that appears with a \* symbol below the template name (see Figure 11-50 on page 307).

OR

1. Press the right arrow (P6 key) to open the **Template** page.
2. Select a saved template (a \* symbol appears to the right of the template name), then press **Load** (P2 key).

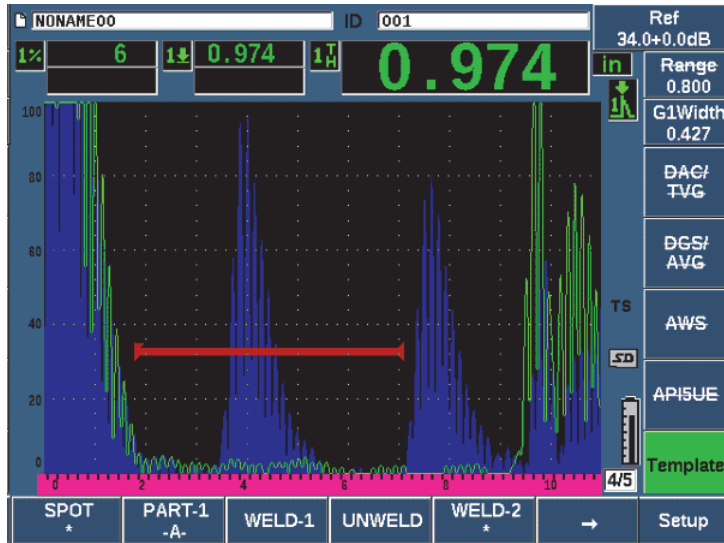



Figure 11-50 Stored template display in live screen

### To order and delete templates

1. Choose **Template** > **Setup** to display the **Template** setup page (see Figure 11-51 on page 308).
2. Press NEXT until **Template Names** is highlighted, then use the adjustment knob or arrow keys to select a template.
3. Use **MoveUp** (P1 key) or **MoveDown** (P2 key) to change the order of the selected template.
4. Use **Delete** (P3 key) to delete the selected template or **Del All** (P4 key) to delete all the templates.
5. Press  to return to the live screen.

**TEMPLATE**

Template

Gain

Template Name Edit

**Template Names**

- SPOT
- PART - 1
- WELD - 1
- UNWELD
- WELD - 2**
- STICK
- GOOD
- STEP1

MoveUp MoveDown Delete Del All

Figure 11-51 Template setup page

### To customize the live A-scan display

1. Choose **Display Setup > Display Setup** to display the **Display** setup page.
2. In the **Live A-Scan Display** field:
  - Select **Outline** to display the live A-scan as an outline, and the template as filled.
  - Select **Filled** to display the live A-scan as filled, and the template as an outline.

---

## 12. Maintenance and Troubleshooting

---

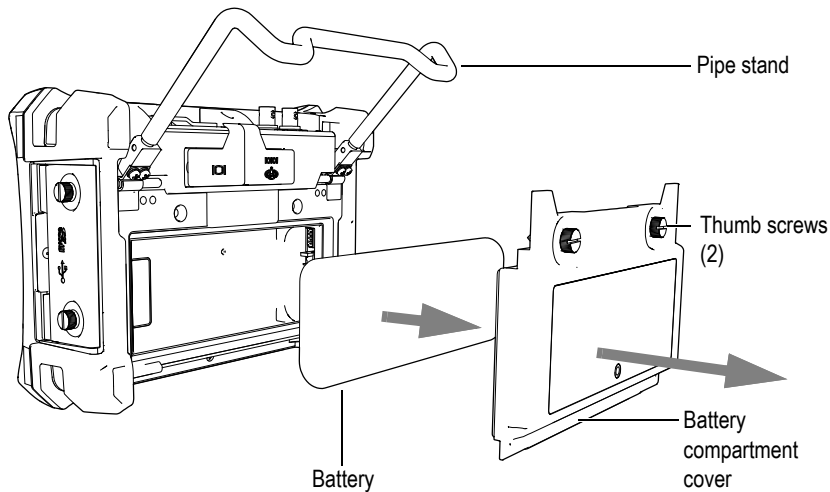
This chapter details the maintenance tasks to be performed on the EPOCH 650 ultrasonic flaw detector and provides a troubleshooting guide.

### 12.1 Replacing the Battery

The lithium-ion (Li-ion) battery is the primary method for powering the EPOCH 650 ultrasonic flaw detector. This battery comes installed in every instrument.

#### To replace the lithium-ion battery

1. Turn off the EPOCH 650 and disconnect DC power.
2. Fully unfold the pipe stand at the back of the instrument (see Figure 12-1 on page 310).
3. Loosen the two thumb screws securing the battery compartment cover and remove the cover.
4. Remove the used battery from the battery compartment.
5. Ensure that the gasket around the battery compartment cover is clean and in good condition.
6. Install a new battery in the battery compartment.  
Make sure the battery connectors align with the connectors in the battery compartment.
7. Install the battery compartment cover, making sure the tab on the cover fits the slot on the bottom of the instrument.
8. Tighten the two thumb screws on the cover.



**Figure 12-1 Removing the lithium-ion battery**

## 12.2 Instrument Cleaning

When needed, wash the instrument only with mild soap and water on a damp cloth.

## 12.3 Verifying O-Ring Gaskets and Seals

The EPOCH 650 ultrasonic flaw detector contains seals that are used to protect the instrument's internal hardware from the environment. These include:

- Battery compartment cover seal
- Side door seal
- Membrane vent
- Main o-ring seals between the top and bottom half of the instrument and the aluminum heat-sink band
- Conventional transducer gasket

Regularly clean and verify the state of the above seals and gaskets to ensure the integrity of the hardware protection.

## 12.4 Protecting the Display

EPOCH 650 ultrasonic flaw detector includes a clear-plastic sheet protecting the display window. Leave the clear-plastic sheet in place when using the instrument to continuously protect the display. Clear-plastic sheet replacements are available from Evident in packages of 10 (P/N: 600-DP [U8780297]).



### CAUTION

The display window is permanently bonded to the upper-half of the instrument case to fully seal the instrument. If the display window is damaged, the entire upper-half of the instrument case and the direct-access keypad must be replaced.

---

## 12.5 Annual Calibration

Evident recommends that you send your EPOCH 650 once a year to an Evident service center for annual calibration. Contact Evident for details.

## 12.6 Troubleshooting

### Symptom

The front panel keys appear to be frozen. The On/Off power key is the only operational front panel key.

### Possible cause

The **All Lock** function is active, locking all front panel keys.

### Solution

Turn the instrument power Off and On to unlock the keys.

Symptom

Several software functions are unavailable.

Possible cause

The **Cal Lock** function is active, locking all front panel keys.

Solution

Turn the instrument power Off and On to unlock the keys.

Symptom

The instrument does not start when pressing the On/Off power key (following a software update).

Possible cause

Interrupted, incomplete, or corrupted software update.

Solution

1. Remove the battery from the EPOCH 650 as well as the AC line power.
2. Replace the battery in the EPOCH 650.
3. Start the unit.



## 13. Specifications

This chapter describes the EPOCH 650 ultrasonic flaw detector specifications.

### 13.1 General and Environmental Specifications

**Table 13 General specifications**

Parameter	Value
Overall dimensions (W × H × D)	236 mm × 167 mm × 70 mm (9.3 in. × 6.57 in. × 2.76 in.) (see on page 313)
Weight	1.6 kg (3.5 lb), including lithium-ion battery
Keypad	English, International, Japanese, Chinese
Languages	English, Spanish, French, German, Italian, Japanese, Chinese, Russian, Portuguese
Transducer connections	BNC or LEMO 01
Data storage	Onboard up to 100,000 IDs with waveform, standard 2 GB microSD card (removable)
Battery type	Single lithium-ion rechargeable standard or standard AA alkaline batteries
Battery life	12 hours
Power requirements	AC Mains: 100 VAC to 120 VAC, 200 VAC to 240 VAC, 50 Hz to 60 Hz
Display type	Full VGA (640 × 480 pixels) transfective color LCD, 60 Hz update rate
Display dimensions (W × H, Diagonal)	132.5 mm × 99.4 mm, 165.1 mm (5.2 in. × 3.9 in., 6.5 in.)
Warranty	1 year limited

**Table 14 Environmental ratings specifications**

<b>Parameter</b>	<b>Value</b>
IP rating	Designed to meet requirements of IP66 (knob configuration) or IP67 (navigation pad configuration)
Explosive atmosphere	MIL-STD-810F Procedure 1, NFPA 70E, Section 500, Class 1, Div. 2, Group D
Shock tested	IEC 60068-2-27, 60 g, 6 $\mu$ s H.S., multiple axes, 18 total
Vibration tested	Sine vibration, IEC 60068-2-6, 50 Hz to 150 Hz at 0.762 mm. (0.03 in.). DA or 2 g, 20 sweep cycles
Operating temperature	-10 °C to 50 °C (-14 °F to 122 °F)
Battery storage temperature	0 °C to 50 °C (32 °F to 122 °F)

## 13.2 Channel Specifications

**Table 15 Pulser specifications**

Parameter	Value
Pulser	Tunable Square Wave
PRF	10 Hz to 2000 Hz in 10 Hz increments
Energy settings	100 V, 200 V, 300 V, or 400 V
Pulse width	Adjustable from 20 to 10,000 ns (0.1 MHz) with PerfectSquare Technology
Damping	50, 100, 200, 400 $\Omega$

**Table 16 Receiver specifications**

Parameter	Value
Gain	0 dB to 110 dB
Maximum input signal	20 V p-p
Receiver input impedance	400 $\Omega$ $\pm$ 5 %
Receiver bandwidth	0.2 to 26.5 MHz at -3 dB
Digital filter settings	30 digital filter sets standard Seven ISO 22232-1:2020 compliant filters (0.2–10 MHz, 2.0–21.5 MHz, 8.0–26.5 MHz, 0.5–4 MHz, 0.2–1.2 MHz, 1.5–8.5 MHz, 5–15 MHz)
Rectification	Fullwave, positive halfwave, negative halfwave, RF
System linearity	Horizontal: $\pm$ 0.2 % FSW
Vertical Linearity	0.25 % FSH, amplifier accuracy $\pm$ 1 dB
Reject	0 % to 80 % FSH with visual warning
Amplitude Measurement	0 % to 110 % full screen height with 0.25 % resolution
Measurement Rate	Equivalent to PRF in all modes

**Table 17 Calibration specifications**

Parameter	Value
Automated calibration	Velocity, zero offset Straight beam (first backwall or echo-to-echo) Angle beam (sound path or depth)
Test Modes	Pulse echo, dual, or through transmission
Units	Millimeters, inches, or microseconds

**Table 17 Calibration specifications (continued)**

Parameter	Value
Range	6.67 mm to 26,628 mm (0.262 in. to 1054.3 in.)
Velocity	635 m/s to 15240 m/s (0.0250 in./ $\mu$ sec to 0.6000 in./ $\mu$ sec)
Zero Offset	0 $\mu$ sec to 750 $\mu$ sec
Display Delay	-65.02 mm to 5,080.75 mm (-560 in. to 200.3 in.)
Refracted Angle	0° to 90° in 0.1° increments

**Table 18 Gate specifications**

Parameter	Value
Measurement gates	2 fully independent gates for amplitude and TOF measurements
Gate start	Variable over entire displayed range
Gate width	Variable from gate start to end of displayed range
Gate height	Variable from 2 % to 95 % full screen height
Alarms	Positive and negative threshold, minimum depth (gate 1 and gate 2)

**Table 19 Measurement specifications**

Parameter	Value
Measurement display locations	5 locations available (manual or auto selection)
Gate 1	Thickness, sound path, projection, depth, amplitude, time-of-flight, min/max depth, min/max amplitude
Gate 2	Same as Gate 1
Echo-to-Echo	Standard Gate2 – Gate1
Other Measurements	Overshoot (dB) value for DGS/AVG, ERS (equivalent reflector size) for DGS/AVG, AWS D1.1/D1.5 A, B, C and D values, reject value, Echo to Ref dB values
DAC/TCG	Standard
DAC Points	Up to 50 points, 110 dB dynamic range
Special DAC Modes	20–80 % DAC, custom DAC (up to 6 curves)
Curved Surface Correction	Standard OD or bar correction for angle beam measurements

## 13.3 Input/Output Specifications

Table 20 on page 317 provides the specifications for the input output signals.

**Table 20 Input/output specifications**

Parameter	Value
USB ports	1 USB On-The-Go (OTG)
Video output	VGA output standard
RS-232	Yes
Analog outputs	1 analog output, selectable 1 V/10 V full scale, 4 mA max. (optional)
Alarm outputs	3 alarm outputs, 5 V TTL, 10 mA
Trigger I/O	Trigger input, 5V TTL; Trigger output, 5V TTL, 10mA max
Encoder Inputs	1-axis encoder line (quadrature - Corrosion Module only)

Table 21 on page 317 describes all the connections available on the Digital Out 15-pin D-sub connector. Table 22 on page 318 describes all the connections available on the VGA Out 15-pin connector.

**Table 21 EPOCH 650 15-pin digital port output**

Pin	Signal	Description
1	ALARM GATE2	Gate 2 Alarm
2	TRIG OUT	Trigger Sync Output
3	RS232 TXD	Transmit Data (Serial)
4	RS232 RTC DTR	Data Terminal Ready (Serial)
5	RS232 RXD	Receive Data (Serial)
6	RS232 CTS DSR	Data Set Ready (Serial)
7	GND	Ground
8	+5V	+5 V voltage
9	BSCAN INT X	X-Axis Encoder Increment
	BSCAN DIR X	X-Axis Encoder Direction
	GND	Ground

**Table 21 EPOCH 650 15-pin digital port output (continued)**

Pin	Signal	Description
	ALARM_GATE 1	Gate 1 Alarm
	TRIG_IN Trigger	Sync Input
	ALARM_GATE_IF	Interface Gate Alarm
	EXT_BEEPER	External Beeper (PWM)

**Table 22 EPOCH 650 15-pin VGA port output<sup>a</sup>**

Pin	Signal	Description
1	VGA_RED	VGA red output
2	VGA_GREEN	VGA green output
3	VGA_BLUE	VGA blue output
4	NC	Not connected
5	GND	Ground
6	GND	Ground
7	GND	Ground
8	GND	Ground
9	NC	Not connected
10	GND	Ground
11	NC	Not connected
12	NC	Not connected
13	LCD_HSYNC	Horizontal sync.
14	LCD_VSYNC	Vertical sync.
15	NC	Not connected

a. Standard VGA output configuration

## Appendix A: Sound Velocities

Table 23 on page 319 lists the ultrasonic velocity in a variety of common materials. This is only a guide. The actual velocity in these materials might vary significantly due to a variety of causes, such as, composition, preferred crystallographic orientation, porosity, and temperature. For maximum accuracy, establish the sound velocity in a given material by first testing a sample of the material.

**Table 23 Ultrasonic velocities in a variety of common materials**

Material	V (in./ $\mu$ s)	V (m/s)
Acrylic resin (Perspex)	0.107	2730
Aluminum	0.249	6320
Beryllium	0.508	12900
Brass, naval	0.174	4430
Copper	0.183	4660
Diamond	0.709	18000
Glycerin	0.076	1920
Inconel <sup>®</sup>	0.229	5820
Iron, Cast (slow)	0.138	3500
Iron, Cast (fast)	0.220	5600
Iron oxide (magnetite)	0.232	5890
Lead	0.085	2160
Lucite <sup>®</sup>	0.106	2680
Molybdenum	0.246	6250
Motor oil (SAE 20/30)	0.069	1740

**Table 23 Ultrasonic velocities in a variety of common materials (continued)**

Material	V (in./ $\mu$ s)	V (m/s)
Nickel, pure	0.222	5630
Polyamide (slow)	0.087	2200
Nylon, fast	0.102	2600
Polyethylene, high density (HDPE)	0.097	2460
Polyethylene, low density (LDPE)	0.082	2080
Polystyrene	0.092	2340
Polyvinylchloride, (PVC, hard)	0.094	2395
Rubber (polybutadiene)	0.063	1610
Silicon	0.379	9620
Silicone	0.058	1485
Steel, 1020	0.232	5890
Steel, 4340	0.230	5850
Steel, 302 austenitic stainless	0.223	5660
Steel, 347 austenitic stainless	0.226	5740
Tin	0.131	3320
Titanium, Ti 150A	0.240	6100
Tungsten	0.204	5180
Water (20°C)	0.0580	1480
Zinc	0.164	4170
Zirconium	0.183	4650

## References

1. Folds, D. L. "Experimental Determination of Ultrasonic Wave Velocities in Plastics, Elastomers, and Syntactic Foam as a Function of Temperature." Naval Research and Development Laboratory. Panama City, Florida, 1971.
2. Fredericks, J. R. *Ultrasonic Engineering*. New York: John Wiley & Sons, Inc., 1965.
3. *Handbook of Chemistry and Physics*. Cleveland, Ohio: Chemical Rubber Co., 1963.
4. Mason, W. P. *Physical Acoustics and the Properties of Solids*. New York: D. Van Nostrand Co., 1958.
5. Papadakis, E. P. Panametrics - unpublished notes, 1972.



---

## Appendix B: Data File Types

---

EPOCH 650 ultrasonic flaw detectors enable you to create several file types based on application requirements. There are two standard file types, calibration and incremental, and advanced file types for corrosion-style data logging.

### B.1 Calibration file type

A calibration (CAL) file is designed specifically for storing calibration setups. Calibration files have space to store one single ID with its corresponding waveform and data. Separate calibration files are created for the different transducers, materials, or test parts being used. The advantage to storing setup data in calibration files is that the data can be quickly recalled to the live screen using the Quick Recall parameter.

### B.2 Incremental file type

Incremental (INC) files are designed for general inspection data storage, and can contain more than one ID for storing file data. Each time the file is saved, the ID increments using the following incrementing rules:

- Only the portion of an ID number that consists of digits and letters (no punctuation marks), beginning with the right-most character and extending leftward to the first punctuation mark or to the left-most character (whichever comes first), can increment.
- Digits are cycled 0, 1, 2,..., 9, 0, and so on. The 9 to 0 transition is done only after incrementing the character to the left. Letters are cycled A, B, C,..., Z, A, and so on. The Z to A transition is done only after incrementing the character to the left. In either case, if there is no character to the left or if the character to the left is a punctuation mark, then the ID number cannot increment.

- If an ID number cannot increment, then after a measurement reading is saved, an error beep sounds, and the momentary message “Cannot Increment ID” is shown on the display above the function keys. Subsequent saves overwrite measurement readings if you do not manually change the ID number first.

See “Example of automatically generated incremented ID number series” on page 323.

---

**Example of automatically generated incremented ID number series**

- |    |         |           |
|----|---------|-----------|
| 1. | Initial | 1         |
|    |         | 2         |
|    |         | 3         |
|    |         | .         |
|    |         | .         |
|    | Limit   | 9         |
| 2. | Initial | ABC       |
|    |         | ABD       |
|    |         | ABE       |
|    |         | .         |
|    |         | .         |
|    |         | .         |
|    |         | ABZ       |
|    |         | ACA       |
|    |         | ACB       |
|    |         | .         |
|    |         | .         |
|    |         | .         |
|    | Limit   | ZZZ       |
| 3. | Initial | ABC*12*34 |
|    |         | ABC*12*35 |
|    |         | ABC*12*36 |
|    |         | .         |
|    |         | .         |
|    |         | .         |
|    | Limit   | ABC*12*99 |
| 4. | Initial | 0001      |
|    |         | 0002      |
|    |         | 0003      |
|    |         | .         |
|    |         | .         |
|    |         | .         |
|    |         | 0009      |
|    |         | 0010      |
|    |         | .         |
|    |         | .         |
|    |         | .         |
|    | Limit   | 9999      |

5. Initial	1A
	1B
	1C
	.
	.
	.
	1Z
	2A
	2B
	.
	.
	.
Limit	9Z

## B.3 Advanced File Types

The EPOCH 650 features a full corrosion-style data logger with its advanced file types. These files have specific configurations of IDs, which are designed for use in many corrosion applications.

### B.3.1 Sequential

A sequential (SEQ) file is defined by a starting and an ending ID number. The resulting file includes the starting and ending points and all points in between (see Table 24 on page 324 and Table 25 on page 325).

**Table 24 Example of start ID# = ABC123**

```
Start ID# = ABC123
End ID# = ABC135

Resulting file would contain the
    following list of ID numbers:
ABC123
ABC124
ABC125
.
.
.
ABC135
```

**Table 25 Example of start ID# = XY-GY**

```
Start ID# = XY-GY
End ID# = XY-IB
Resulting file would contain the
    following list of ID numbers:
XY-GY
XY-GZ
XY-HA
.
.
.
XY-IB
```

A sequential file with custom points (SEQ + CPT) is defined by a starting and ending ID number plus a series of custom points. The resulting file includes the starting and ending points and all points in between. In addition, multiple measurements per ID number location are assigned using the custom points. You can enter up to 20 custom points. The total number of characters of an ID with custom points is 19.

The following example describes measurements along a pipe or tube where at each ID number location you can take a measurement at the top, bottom, left, and right of the pipe (see Table 26 on page 326).

**Table 26 Example of starting ID# = XYZ1267**

```
Starting ID# = XYZ1267
Ending ID# = XYZ1393

Custom Points = TOP
BOTTOM
LEFT
RIGHT

Resulting file would contain the following
list of ID numbers:
XYZ1267TOP
XYZ1267BOTTOM
XYZ1267LEFT
XYZ1267RIGHT
XYZ1268TOP
XYZ1268BOTTOM
XYZ1268LEFT
.
.
.
XYZ1393RIGHT
```

### B.3.2 2-D Matrix Grid

A two dimensional (2D) file sequence begins with the ID number that refers to the first column and the first row. Then the column (or row) increments one value at a time until the sequence reaches the last column (or row) value while the other dimension stays constant. At this point, the other dimension increases from its first to its next value. This continues until the ID number that refers to the last column and last row is reached. Either the columns or the rows can be selected to increment first (see Figure 13-1 on page 327).

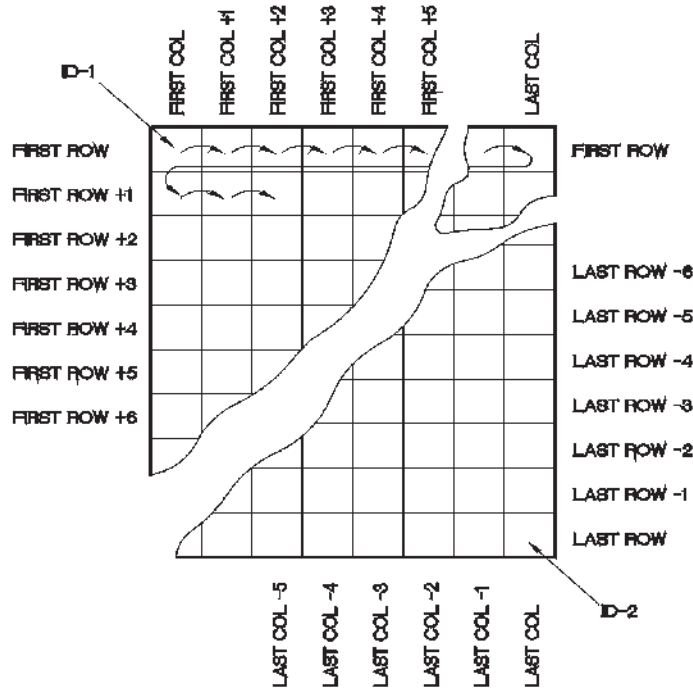
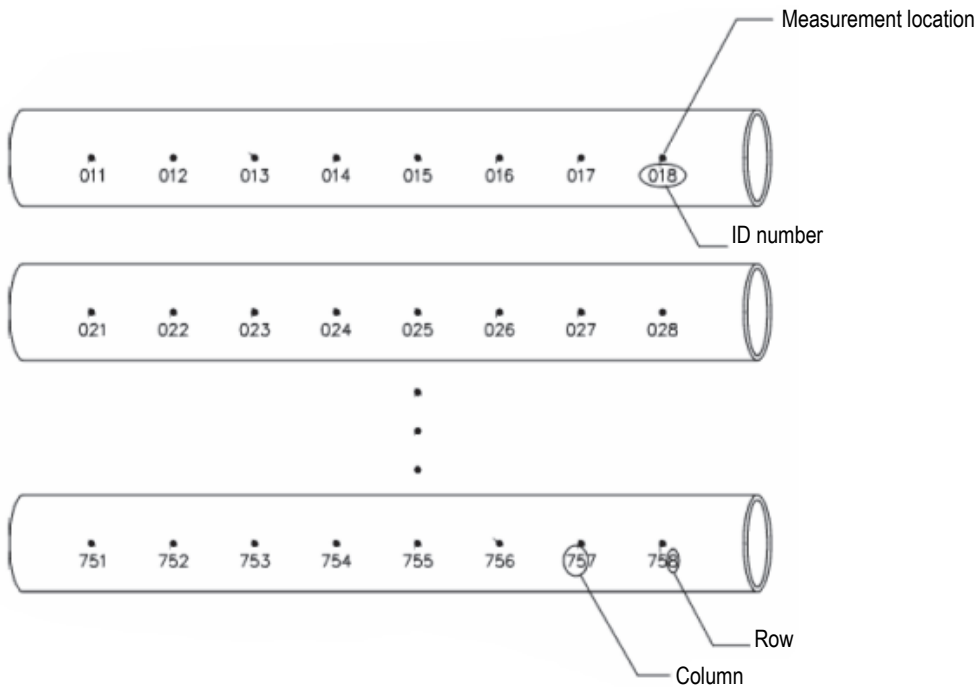


Figure 13-1 2-D matrix grid

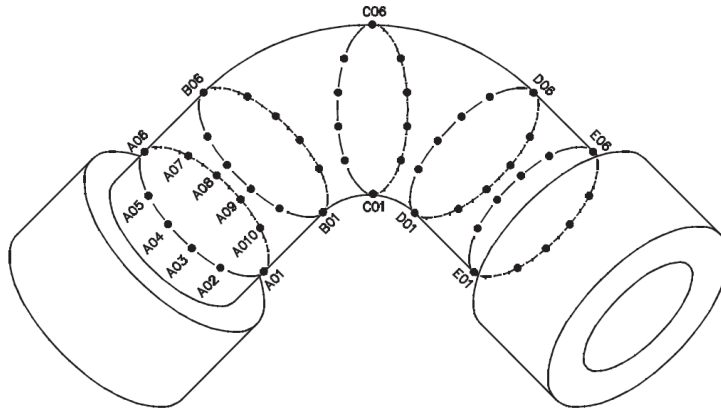
How is a grid used? A grid structure may associate one dimension of the grid (for example, the columns) with the physical parts whose wall thickness is to be measured. The particular measurement points on each part are then associated with the other dimension of the grid (for example, the rows). See Figure 13-2 on page 328.



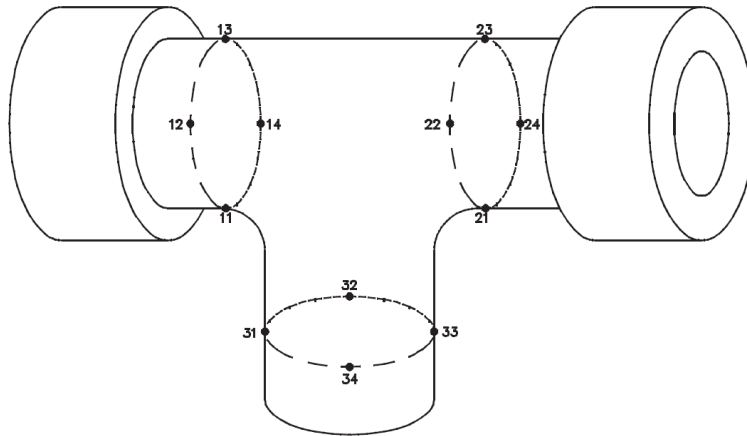
**Figure 13-2 One grid for 75 identical parts**

Alternatively, the rows and columns of a grid can refer to a 2-D map of measurement points on the surface of one part. In this case, a different grid is made for each part (see Figure 13-3 on page 329).





**Name:** Elbow  
**Rows:** 01 through 10  
**Columns:** A through E  
**ID's:** Elbow/A0 through Elbow/E10



**Name:** Tee  
**Rows:** 1 through 4  
**Columns:** 1 through 3  
**ID's:** Tee/11 through Tee/34

**Figure 13-3** Different named grid for each part

### B.3.3 2-D EPRI

The 2-D EPRI file (2DEPR) is the same as the standard 2-D grid file type except for a minor change in the way alpha characters increment:

- Standard 2-D grid file: Refers to the standard incrementing columns that start at A and extend past Z. (Example: Start Column: A; End Column: AD; Column Result: A, B, C...X, Y, Z, AA, AB, AC, AD.)
- EPRI 2-D grid file: Refers to custom incrementing columns that start at A and extend past Z. (Example: Start Column: A; End Column: CC; Column Result: A, B, C...Z, AA, BB, CC.)

### B.3.4 2-D Matrix Grid with Custom Point

A 2-D matrix grid with custom points (2D + CPT) file is the same as a standard 2-D grid file with the addition of custom points. Custom points allow multiple readings per grid ID number to be assigned (see Table 27 on page 330).

**Table 27 Example of 2-D matrix grid with custom point**

```
Start Column A
End Column J (Start Grid Coordinate = A01)
Start Row 01
End Row 17 (End Grid Coordinate = J17)
Custom Points = LEFT
CENTER
RIGHT
Resulting file would contain the following
    list of ID Numbers:
A01LEFT
A01CENTER
A01RIGHT
A02LEFT
.
.
.
J17RIGHT
```

### B.3.5 3-D Matrix Grid

A three-dimensional (3D) grid file sequence begins with the ID number that refers to the first column, the first row, and the first point. Then the point (or column, or row) increments one value at a time until the sequence reaches the last point (or column, or row) value while the other two dimension values stay constant. Then, another dimension increments from its first to its next value. This continues until the ID number that refers to the last column, last row and last point is reached. You can select either columns, rows, or points to increment first and one of the remaining two selections to increment second.

How is a 3-D grid used? A 3-D grid structure may associate two dimensions of the grid (for example, the columns and rows) with the physical coordinates on the part whose wall thickness is to be measured. The particular measurement points on each part are then associated with the third dimension of the grid. This scenario enables multiple readings to be stored at each grid coordinate (see Table 28 on page 331).

**Table 28 Example of 3-D grid**

```
Start Col = A
End Col = F
Start Row = 1
End Row = 4
Start Point = X
End Point = Z

Resulting file would contain the following
list of ID numbers:
A1X
A1Y
A1Z
A2X
.
.
.
A4Z
B1X
B1Y
.
.
.
F4Z
```

### B.3.6 Boiler

A boiler (BOILER) file is a special file type designed specifically for boiler applications. A common method for identifying a thickness measurement location is by a 3-D approach. The first dimension is Elevation, which refers to the physical distance from the bottom to the top of the boiler. The second dimension is Tube Number, which refers to the number of boiler tubes that need inspection. The third dimension is the Custom Point, which refers to the actual thickness reading location at the specified elevation on the specified tube. When these three dimensions are combined, a single ID number is formed to precisely identify the exact location of each thickness reading (see Table 29 on page 332).

**Table 29 Example of a BOILER file**

```
Elevations = 10ft-, 20ft-, 45ft-. 100ft-
Start Tube = 01
End Tube = 73
Custom Points = L,C, R (left, center, right)

The resulting file would contain the following list of ID numbers:
10ft-01L
10ft-01C
10ft-01R
10ft-02L
.
.
.
10ft-73R
20ft-10L
.
.
.
100ft-73C
100ft-73R

(This example assumes that you have chosen to increment the custom
points first, tube number second, and elevation third. You can
choose alternate incrementing methods.)
```

## Appendix C: Glossary

**Table 30 Glossary**

<b>Term</b>	<b>Definition</b>
Acoustic impedance	A material property defined as the product of sound velocity (C) and material density (d).
Acoustic interface	The boundary between two media of different acoustic impedance.
Acoustic velocity	The speed of sound in a test material. Different wave modes such as longitudinal and shear will have different velocities.
Amplifier	An electronic device that increases the strength of a signal fed into it by obtaining power from a source other than the input signal.
Amplitude	The height of an indication on a waveform display, measured from the lowest to the highest point on the indication. This corresponds to relative signal strength and is often referred to as %FSH (percent full screen height).
Analog output	A data output format consisting of a DC voltage whose amplitude corresponds to a measured parameter such as echo amplitude or depth.
Angle beam transducer	A transducer that transmits or receives the acoustic energy at an angle to the surface to generate refracted shear waves or surface waves in the part being inspected.

**Table 30 Glossary (continued)**

Term	Definition
A-scan	The most common waveform display format, plotting signal amplitude versus distance. An A-Scan shows the pulse travel time in the horizontal direction (left to right), representing the corresponding sound paths, and the echo amplitude in the vertical direction.
Attenuation	The loss in acoustic energy that occurs between any two points of travel. This loss may be due to absorption, reflection, scattering, and other phenomena.
Backwall echo	The echo received from the side of the test piece opposite the side to which the transducer is coupled. This echo represents the thickness of the test piece at that point.
Background noise	Extraneous signals caused by sources within the ultrasonic testing system and/or the material being tested.
Beam-index point (BIP)	For an angle beam probe, the point where the sound leaves the wedge and enters the specimen.
Cal. block velocity	Material sound velocity for the calibration block.
Couplant	A material (usually a liquid or gel) used between the transducer and the test piece to eliminate air from this space and facilitate the passage of sound waves into and out of the specimen.
Critical defect	Either the largest tolerable defect or the smallest intolerable defect. The critical defect size is usually given by a specification or code.
Cross talk	An unwanted condition affecting dual element transducers in which acoustic energy travels from the transmitting crystal to the receiving crystal by routes other than the intended path through the test piece.
Damping (control)	A variable resistance across the pulser circuit output which shapes the excitation pulse. Typically it is used to change pulse characteristics to optimize either penetration (low damping) or near-surface resolution (high damping).

**Table 30 Glossary (continued)**

Term	Definition
Damping material	Any epoxy or other high attenuation material used in the transducer to shorten the ringing time of the piezoelectric element.
Decibel (dB)	<p>A unit which compares levels of power, commonly used to express relative sound intensities in ultrasonic testing. Two amplitude levels V1 and V2, expressed as either voltages or screen percentages, are said to differ by n decibels where:</p> $\text{dB} = 20 \log (V2 / V1)$
Delay control	Software function that introduces an adjustable time period between the excitation pulse and the start of the sweep across the data display.
Detectability	The ability of a test system (instrument and transducer) to detect or “see” a given size reflector.
Distance amplitude correction (DAC)	A method of flaw sizing that plots an on-screen curve representing the echo amplitude from a known size reflector at varying distances from the transducer. This curve compensates for the loss of energy due to beam spreading and attenuation.
Distance Gain Sizing (DGS)	A sizing technique that mathematically relates the amplitude of the echo from a reflector to that of a flat bottom hold at the same depth or distance. The generated curves are derived from the calculated beam spreading pattern of a given transducer, based on its frequency and element diameter, and adjusted for material attenuation.
Dual element probe	A transducer containing two piezoelectric elements, one which transmits and one which receives.
Dynamic range	The range of gain or signal amplitude that can be displayed on a given instrument.

**Table 30 Glossary (continued)**

Term	Definition
Excitation pulse	The pulse of electrical energy sent by the pulser to the transducer, sometimes known informally as the main bang. Both spike (broadband) and square wave (tuned) excitation pulses are commonly used.
Filter	Receiver function that passes selected frequency components of a signal and rejects others, used to improve signal-to-noise, near surface resolution, and dynamic range. Filters may be high pass, low pass, narrowband, or broadband.
First critical angle	In angle beam or immersion testing, the minimum incident angle in the wedge or water path at which the refracted longitudinal wave disappears from the test piece.
Flaw	A discontinuity that may be undesirable but does not necessarily call for rejection, depending on procedural requirements.
Frequency	The number of complete cycles per second undergone or produced by an oscillating as body expressed the reciprocal of the period $t$ . $f = 1/t$
Gain	Used in electronics with reference to an increase in signal power; usually expressed as the ratio of the output power to the input power in decibels.
Gate	A software function that selects and marks a portion of the displayed range for measurement of distance or amplitude.
Hertz (Hz)	The unit of frequency, defined as the frequency of a periodic phenomenon of which the period is one second; equal to one cycle per second. 1 kilohertz (kHz) = $10^3$ cycles per second 1 megahertz (MHz) = $10^6$ cycles per second.



**Table 30 Glossary (continued)**

Term	Definition
Immersion testing	A test method in which a water bath or a water column is used to couple sound energy from the transducer to the test piece. It is commonly used in automated scanning applications.
Incidence, angle of	The angle between a sound beam striking an acoustic interface and the normal (perpendicular) orientation to the surface at that point. Usually designated by the Greek symbol $\alpha$ (alpha).
Indication	A displayed signal signifying the presence of a sound wave reflector.
Indication (defect) level	The amount of gain which must be added to an instrument setup to bring an indication (defect) echo signal to peak at a selected reference level.
Leg	In angle beam testing, the path the shear wave travels in a straight line before being reflected by the opposite surface of the material being tested.
Linearity, vertical or amplitude	The degree to which an ultrasonic instrument responds in a proportional manner to a range of echo amplitudes produced by specified reflectors.
Linearity, horizontal or distance	The degree to which an ultrasonic instrument responds in a proportional manner to a range of echo signals produced by specified reflectors at different points in time.
LOS	Acronym for loss of signal.
Longitudinal wave	Mode of wave propagation characterized by particle movement parallel to the direction of wave travel.
Main bang	Informal term for excitation pulse.
Mode conversion	The change of a portion of sound beam energy into a wave of a different mode due to refraction at incident angles other than zero degrees. In NDT, this usually involves conversion of longitudinal waves into shear waves or surface waves.

**Table 30 Glossary (continued)**

Term	Definition
Peaking Memory	A software function that records an echo envelope as the transducer scans across a test piece by capturing and storing on the screen the peak echo amplitude at each pixel location
Peaking up	Maximizing the height of a displayed indication by optimizing the position of the sound beam.
Penetration	The ability of the test system to overcome signal amplitude loss across a sound path due to factors like attenuation, scattering, and beam spreading.
Piezoelectric materials	A family of materials (such as quartz, lead metaniobate and lead zirconium titanate) that possess the characteristic ability to produce a voltage differential across their faces when deformed by an externally applied mechanical force, and a change in their own physical configuration (dimensions) when an external voltage is applied to them.
Pitch-catch	A test method which utilizes separate transmitting and receiving transducers on the same side of the test piece.
Probe	In ultrasonic testing, an alternate name for transducer.
Pulse repetition frequency (PRF)	The frequency at which an instrument generates an excitation pulse and initiates a data acquisition cycle. Also known as Pulse Repetition Rate.
Range	The total distance represented by the horizontal display axis.
Receiver	The circuits a flaw detector that receive and process returning echoes (as voltages) from the transducer. Typical signal processing includes amplification, filtering, and rectification.

**Table 30 Glossary (continued)**

Term	Definition
Rectification	Receiver function that selects display of waveforms as an RF signal with both positive and negative deflections, a full wave rectified signal in which all deflections are displayed as positive, or half wave negative and positive in which only one side of the RF signal is displayed as a positive deflection.
Reference echo	The echo from a specified reference reflector.
Reference gain (reference level)	A gain level established by a test procedure, commonly by setting a reference reflector echo to a specified height.
Reference line	A designated percentage of total screen height at which reference echoes and indication echoes are compared.
Reference reflector	A reflector of known size and geometry at a known distance, such as a flat bottom hole.
Refraction, angle of	The angle with respect to perpendicular of the sound beam in the test material, generated by refraction from the angle of incidence in the wedge.
Reject (control)	Also known as suppression, this limits the input sensitivity of the amplifier in the receiver to display only indications greater than a selected height. It is used to reduce or eliminate “grass” or scattering noise from the display.
Resolution	The ability of the test system (instrument and transducer) to distinguish between two reflectors at slightly different depths, or within a given distance of the surface of the test piece.
Scanning gain	The amount of gain above the reference level added per procedure to optimize visibility of indications.
Second critical angle	In angle beam or immersion testing, the minimum incident angle in the wedge or water path at which the refracted shear wave disappears from the test piece.

**Table 30 Glossary (continued)**

<b>Term</b>	<b>Definition</b>
Sensitivity	The ability of the test system (instrument and transducer) to detect a given size reflector at a given distance.
Signal-to-noise ratio	The amplitude ratio between the echo from a given indication and background indications such as grain scattering or instrument noise.
Single element probe	A transducer containing only one piezoelectric element, which is used to both transmit and receive sound.
Skip-distance	In angle beam testing, the surface distance which represents one V-path of sound in the material.
Sound beam	The characteristic shape of the ultrasonic wave in a test piece.
Sound path distance	The distance between the transducer and a reflector. In angle beam and immersion testing, this is commonly measured from the point at which sound enters the test piece. This is sometimes referred to as angular distance in angle beam testing.
Straight beam probe (Normal beam probe)	A transducer that transmits sound into the test piece perpendicular to the entry surface.
Surface wave	A mode of wave propagation characterized by an elliptical movement of the particles on the surface of the specimen as the wave front moves forward, penetrating the specimen to a depth of one wavelength.
Through transmission	A test method in which the pulses from a transmitting transducer are received by a second transducer on the opposite side of the test piece.
Time-corrected gain (TCG)	A software function that adjusts instrument gain so that the echo amplitude of a given size reflector is displayed at a constant display height regardless of the distance to that given size reflector.
Transducer	A device that transforms one form of energy into another.

**Table 30 Glossary (continued)**

Term	Definition
Transmitter	Circuit of the flaw detector that sends the initial pulse voltage to the transducer.
Ultrasonic	Frequencies above the human audible range (above 20 kHz).
V-path	The angular distance sound travels, measured from the top surface of the material to the bottom, and reflecting back up to the top surface.
Wavelength	The distance between like points on successive wave fronts; such as the distance between any two successive particles of the oscillating medium that are in the same phase. It is denoted by the Greek letter $\lambda$ (lambda).
Zero offset	A time offset between the moment the excitation pulse is generated and the point at which the screen display and measurement begins, typically used to subtract transit time through a wedge, delay line, or wear plate from a depth or distance measurement.



## Appendix D: Parts List

**Table 31 EPOCH 650 basic kit (spares can be purchased)**

Part Number	U8 Number	Description
EP600-BA-UEE-K	U8051216	EPOCH 650 instrument NOTE: The part number vary according to the instrument configuration. The instrument can be adapted to have different keypads, manual languages, power cords, etc. Contact your Evident representative for further information.
EP-MCA-X	See note	AC charger/adaptor NOTE: The part number vary according to the instrument configuration. You must specify the power cord type.
600-BAT-L-2	U8760056	EPOCH 650 lithium-ion rechargeable battery
600-TC	U8780294	EPOCH 650 instrument transport case
EP650-MANUAL-CD	Q7780010	EPOCH 650 <i>User's Manual</i> (CD-Rom)
DMTA-10056-01EN	Q7780001	EPOCH 650 <i>Getting Started Guide</i>
MICROSD-ADP-2GB	U8779307	2 GB microSD memory card with adaptors

**Table 32 EPOCH 650 software options**

<b>Part Number</b>	<b>U8 Number</b>	<b>Description</b>
EP600-DGS-AVG	U8140146	EPOCH 650 onboard DGS/AVG software option
EP600-AWS	U8140147	EPOCH 650 AWS D1.1/D1.5 software option
EP600-TEMPLATE	U8140148	EPOCH 600 template storage software option
EP600-API5UE	U8140149	EPOCH 600 API 5UE software option
EP600-XDATA	U8140150	EPOCH 600 expanded data logger software option
EP600-AVERAGE	U8140151	EPOCH 600 waveform averaging software option
GAGEVIEWPRO	U8140075	GageView Pro PC interface software
GAGEVIEWPRO-KIT-USB-A-AB	U8140076	GageView Pro PC interface software with USB A-AB cable, 6 feet

**Table 33 EPOCH 650 optional accessories**

<b>Part Number</b>	<b>U8 Number</b>	<b>Description</b>
EPXT-EC-X	See note	EPOCH external charger NOTE: The part number vary according to the instrument configuration. You must specify the power cord type.
600-STAND	U8780296	EPOCH 650 pipe stand assembly
EP4/CH	U8140055	EPOCH Series chest harness
600-DP	U8780297	EPOCH 650 display protectors (pack of 10)



**Table 33 EPOCH 650 optional accessories (continued)**

<b>Part Number</b>	<b>U8 Number</b>	<b>Description</b>
EPLTC-C-USB-A-6	U8840031	EPOCH LTC USB communication cable (mini-AB to TYPE-A/HOST)
EPLTC-C-USB-B-6	U8840033	EPOCH LTC USB communication cable (mini-AB to TYPE-B/CLIENT)
600-C-VGA-5	U8780298	5-feet EPOCH 600 VGA cable (1.5 meter)
EP1000-C-9OUT-6	U8779017	6-feet standard 9-pin communication cable (1.8 meter)
600-C-RS232-5	U8780299	5-feet EPOCH 600 RS-232 cable (1.5 meter)
EP600-WARRANTY	U8780300	EPOCH 650 extended warranty (1 additional year)



---

## List of Figures

---

Figure i-1	Transport case contents .....	29
Figure 1-1	EPOCH 650 front view .....	31
Figure 1-2	EPOCH 650 rear view .....	32
Figure 1-3	The EPOCH 650 — Adjustment knob configuration .....	33
Figure 1-4	The EPOCH 650 — Navigation pad configuration .....	33
Figure 1-5	Coarse (left) and fine (right) adjustment selection .....	34
Figure 1-6	The EPOCH 650 — Adjustment knob configuration .....	35
Figure 1-7	Knob configuration (English and international versions) .....	36
Figure 1-8	Knob configuration (Chinese and Japanese versions) .....	37
Figure 1-9	The EPOCH 650 — Navigation pad configuration .....	38
Figure 1-10	Pad configuration (English and international versions) .....	39
Figure 1-11	Pad configuration (Chinese and Japanese versions) .....	40
Figure 1-12	Function and parameter keys .....	43
Figure 1-13	Menu system software buttons .....	44
Figure 1-14	AC charger/adaptor power indicator .....	44
Figure 1-15	Alarm indicators .....	45
Figure 1-16	Location of the transducer connectors .....	46
Figure 1-17	The RS-232/Alarms and VGA Out connectors .....	49
Figure 1-18	The connectors behind the protective cover .....	50
Figure 1-19	Installing the microSD card .....	51
Figure 1-20	The battery compartment .....	52
Figure 1-21	Instrument resting on stand .....	53
Figure 2-1	Location of the EPOCH 650 power key and indicator .....	55
Figure 2-2	Connecting the charger/adaptor .....	58
Figure 2-3	Connecting the DC power plug .....	58
Figure 2-4	Front panel AC charger/adaptor power indicator .....	59
Figure 3-1	Software main display elements .....	61
Figure 3-2	The menu groups and their level numbers .....	62
Figure 3-3	F1 key selecting the Basic function .....	62
Figure 3-4	The focus is on the selected parameter (green) .....	63

Figure 3-5	P3 key selecting the Range parameter .....	64
Figure 3-6	Adjustment knob configuration — Lock key .....	66
Figure 3-7	The AUTO XX% feature: inactive (left) and active (right) .....	66
Figure 3-8	The reference and scanning gains .....	68
Figure 3-9	The Gate 1 start position adjustment .....	70
Figure 3-10	Trigger in Edge and Peak modes .....	72
Figure 3-11	Trigger in 1stPeak, and J-Flank modes .....	73
Figure 3-12	Gate 1 and gate 2 alarm indicator lights .....	73
Figure 3-13	The Auto Cal menu .....	75
Figure 3-14	The Cal-Zero value .....	76
Figure 3-15	The gate 1 start .....	77
Figure 3-16	The Velocity Cal value .....	78
Figure 3-17	The Range value .....	78
Figure 3-18	Reference gain setting .....	79
Figure 3-19	The Create screen with virtual keypad .....	81
Figure 3-20	The Save dialog box .....	82
Figure 3-21	The Resets page .....	83
Figure 4-1	Software main display elements .....	85
Figure 4-2	Software display elements in full screen mode .....	86
Figure 4-3	File identifier bar with ID example .....	87
Figure 4-4	Message bar with a message example .....	87
Figure 4-5	Example of the Gain, Range, and Delay direct-access parameters .....	88
Figure 4-6	Direct access preset values .....	89
Figure 4-7	Example of measurement reading boxes with their icons .....	89
Figure 4-8	Example of an A-scan waveform with gates .....	90
Figure 4-9	The area displaying flags .....	91
Figure 4-10	Standard menu groups .....	95
Figure 4-11	The Display setup page and its elements .....	99
Figure 4-12	The Edit page with its virtual keyboard .....	100
Figure 4-13	The Display setup page .....	101
Figure 4-14	The Reading setup page .....	103
Figure 4-15	Example of measurement reading boxes with icons .....	104
Figure 4-16	The General Setup page .....	108
Figure 4-17	The Status setup page .....	110
Figure 4-18	The Clock setup page .....	111
Figure 4-19	Misc setup page .....	114
Figure 4-20	Editable Parameters setup page .....	115
Figure 6-1	Horizontal line indicating the reject level .....	128
Figure 6-2	Peak memory signal envelope example .....	129
Figure 6-3	Selecting the x-axis grid mode .....	132
Figure 6-4	The x-axis grid modes .....	133
Figure 6-5	The y-axis grid modes: 100 % (left), 110 % (right) .....	134

---

Figure 7-1	Gate 1 and gate 2 (with echo-to-echo turned on) .....	135
Figure 7-2	The Gate 1 menu .....	136
Figure 7-3	The direct-access gate parameter box .....	137
Figure 7-4	The Gate Setup menu .....	139
Figure 7-5	Trigger indicator on gate in Edge and Peak modes .....	140
Figure 7-6	Trigger indicator on gate in 1stPeak, and J-Flank modes .....	141
Figure 7-7	Echo-to-echo measurement example .....	143
Figure 7-8	Gate tick marks indicating alarm threshold type .....	146
Figure 7-9	Minimum depth alarm marker .....	147
Figure 8-1	The A-Out setup page .....	153
Figure 9-1	Example of a gated signal for zero calibration .....	159
Figure 9-2	Entering the Zero Cal thickness value .....	160
Figure 9-3	Example of a gated signal for velocity calibration .....	161
Figure 9-4	Entering the Velocity Cal thickness value .....	162
Figure 9-5	Adjusting zero offset for the first delay line echo .....	164
Figure 9-6	Example of a gated signal for zero calibration .....	165
Figure 9-7	Entering the Zero Cal thickness value .....	166
Figure 9-8	Example of a gated signal for velocity calibration .....	167
Figure 9-9	Entering the Velocity Cal thickness value .....	168
Figure 9-10	Example of a gated signal for zero calibration .....	170
Figure 9-11	Entering the Zero Cal thickness value .....	171
Figure 9-12	Example of a gated signal for velocity calibration .....	172
Figure 9-13	Entering the Velocity Cal thickness value .....	173
Figure 9-14	Example of gated signals for velocity calibration .....	175
Figure 9-15	Entering the Velocity Cal thickness value .....	176
Figure 9-16	IIW block with probe at 0 mark .....	178
Figure 9-17	Using the Peak Memory feature to find the BIP .....	179
Figure 9-18	The IIW block with probe at the 45° mark .....	180
Figure 9-19	Verifying the refracted angle .....	181
Figure 9-20	Example of a gated signal for zero calibration .....	182
Figure 9-21	Entering the Zero Cal thickness value .....	183
Figure 9-22	Example of a gated signal for velocity calibration .....	184
Figure 9-23	Entering the Velocity Cal thickness value .....	185
Figure 9-24	The IIW block with probe facing sensitivity hole .....	186
Figure 9-25	Setting the reference gain .....	187
Figure 9-26	Example of a gated signal for zero calibration .....	189
Figure 9-27	Entering the Zero Cal thickness value .....	190
Figure 9-28	Example of a gated signal for velocity calibration .....	191
Figure 9-29	Entering the Velocity Cal thickness value .....	192
Figure 9-30	The ASTM E164 IIW type calibration block (P/N: TB7541-1) .....	193
Figure 9-31	The IIW type 2 reference block (P/N: TB5939-1) .....	194
Figure 9-32	Distance & sensitivity calibration (DSC) test block (P/N: TB7549-1) .....	195

---

Figure 9-33	The ASTM E164 IIW type metric calibration block (P/N: TB1054-2) .....	196
Figure 9-34	The ISO 7963 MAB calibration block (P/N: TB1065-1) .....	197
Figure 9-35	The Navships cylindrical reflector block (P/N: TB7567-1) .....	197
Figure 9-36	The 5-step precision thickness calibration block (P/N: 2214E) .....	198
Figure 10-1	The File menu parameters .....	204
Figure 10-2	The Create setup page .....	205
Figure 10-3	File name edit .....	206
Figure 10-4	Creating advanced file type .....	207
Figure 10-5	Advanced (Create page two) .....	208
Figure 10-6	The Open page .....	210
Figure 10-7	ID of open file in the live screen .....	210
Figure 10-8	The Details page .....	211
Figure 10-9	Viewing file content (waveform) .....	212
Figure 10-10	Viewing file content (setup) .....	213
Figure 10-11	Select ID page .....	214
Figure 10-12	File measurement summary .....	215
Figure 10-13	The Recall setup menu .....	216
Figure 10-14	Memo setup page .....	217
Figure 10-15	Memo Dictionary page .....	218
Figure 10-16	Populated Memo setup page .....	219
Figure 10-17	The Select ID menu .....	220
Figure 10-18	The Manage menu parameters .....	221
Figure 10-19	Export setup page .....	223
Figure 10-20	Import page .....	224
Figure 10-21	Import (memo) page .....	225
Figure 10-22	The Edit setup menu .....	226
Figure 10-23	The Copy setup menu .....	227
Figure 10-24	The Delete setup menu .....	228
Figure 10-25	Grid controls in the live screen .....	231
Figure 10-26	Grid controls in Contents screen .....	232
Figure 11-1	The Option key entry dialog box .....	238
Figure 11-2	The DAC/TCG setup page .....	240
Figure 11-3	First DAC setup step .....	241
Figure 11-4	DAC Setup one point .....	242
Figure 11-5	Partial DAC curve with each echo set to 80 % FSH .....	243
Figure 11-6	The completed DAC curve .....	244
Figure 11-7	Completed DAC curves in TCG view mode .....	245
Figure 11-8	A small range DAC .....	246
Figure 11-9	Standard DAC with 3 dB scanning gain .....	247
Figure 11-10	DAC with 3 dB scan gain - reference correction active .....	248
Figure 11-11	DAC curves with adjusted gain .....	249
Figure 11-12	Custom DAC setup .....	251

Figure 11-13	Completed custom DAC .....	252
Figure 11-14	DGS/AVG setup page .....	254
Figure 11-15	Reference-reflector before capture .....	257
Figure 11-16	DGS/AVG curves on screen .....	258
Figure 11-17	Gain curve adjusted DGS .....	260
Figure 11-18	AWS setup page .....	263
Figure 11-19	Reference B value before storage .....	264
Figure 11-20	Active AWS with D rating .....	265
Figure 11-21	Completed API 5UE sizing .....	268
Figure 11-22	Waveform averaging option setup .....	269
Figure 11-23	Calibration data in collect mode .....	271
Figure 11-24	The Inspect mode .....	272
Figure 11-25	Storing the $A_{max}$ point .....	274
Figure 11-26	Storing the $T_1$ point .....	275
Figure 11-27	Storing the $T_2$ point .....	276
Figure 11-28	Waveform Averaging option setup .....	278
Figure 11-29	The Waveform Averaging screen .....	279
Figure 11-30	Update rate less than 60 Hz .....	280
Figure 11-31	Activating the BEA .....	281
Figure 11-32	Adjusting back wall gain .....	282
Figure 11-33	Setting the material velocity .....	284
Figure 11-34	Setting the gate interface run mode .....	285
Figure 11-35	Interface gate and TCG .....	286
Figure 11-36	Corrosion Module screen .....	289
Figure 11-37	Corrosion Module grid view .....	290
Figure 11-38	Corrosion Module transducer Setup menu .....	291
Figure 11-39	Incorrectly triggered measurement .....	293
Figure 11-40	Corrosion Module AGC set to Off .....	294
Figure 11-41	Adjusting the Corrosion Module gain value .....	295
Figure 11-42	Corrosion Module echo measurement .....	296
Figure 11-43	Echo measurement error .....	297
Figure 11-44	B-scan menu item .....	299
Figure 11-45	B-Scan setup page .....	301
Figure 11-46	B-scan position indicator .....	302
Figure 11-47	B-scan display in the Data Logger .....	303
Figure 11-48	Template setup page .....	305
Figure 11-49	-A- indicates an active template .....	306
Figure 11-50	Stored template display in live screen .....	307
Figure 11-51	Template setup page .....	308
Figure 12-1	Removing the lithium-ion battery .....	310
Figure 13-1	2-D matrix grid .....	327

Figure 13-2	One grid for 75 identical parts .....	328
Figure 13-3	Different named grid for each part .....	329



---

## List of Tables

---

Table 1	English direct-access key descriptions .....	41
Table 2	EPOCH 650 power status indicators .....	59
Table 3	Filter cutoffs .....	69
Table 4	Button types .....	86
Table 5	Flag description .....	91
Table 6	Content of the first menu group .....	95
Table 7	Content of the second menu group .....	96
Table 8	Content of the third menu group .....	96
Table 9	Content of the fourth menu group .....	96
Table 10	Content of the fifth menu group .....	97
Table 11	Available measurement readings .....	104
Table 12	Advanced filters .....	124
Table 13	General specifications .....	313
Table 14	Environmental ratings specifications .....	314
Table 15	Pulser specifications .....	315
Table 16	Receiver specifications .....	315
Table 17	Calibration specifications .....	315
Table 18	Gate specifications .....	316
Table 19	Measurement specifications .....	316
Table 20	Input/output specifications .....	317
Table 21	EPOCH 650 15-pin digital port output .....	317
Table 22	EPOCH 650 15-pin VGA port output .....	318
Table 23	Ultrasonic velocities in a variety of common materials .....	319
Table 24	Example of start ID# = ABC123 .....	324
Table 25	Example of start ID# = XY-GY .....	325
Table 26	Example of starting ID# = XYZ1267 .....	326
Table 27	Example of 2-D matrix grid with custom point .....	330
Table 28	Example of 3-D grid .....	331
Table 29	Example of a BOILER file .....	332
Table 30	Glossary .....	333

Table 31	EPOCH 650 basic kit (spares can be purchased) .....	343
Table 32	EPOCH 650 software options .....	344
Table 33	EPOCH 650 optional accessories .....	344