

INDUSTRIAL

CIX100

Turnkey Solution for Technical Cleanliness Inspection



EVIDENT

Simplify Your Technical Cleanliness

The cleanliness of components, parts, and fluids is at the center of the manufacturing process. Meeting high standards for counting, analyzing, and classifying the often micron-sized contaminant and foreign particles is important for all processes: development, manufacturing, production, and quality control. International and national directives describe the methods and documentation requirements for determining particle contamination on essential machined parts since these particles directly impact the lifespan of parts and components. As a first step, residue particles are weighed to characterize the technical cleanliness of parts. But the standards in use today demand more detailed information about the nature of the contamination, such as the number of particles, particle size distribution, and particle characteristics.

The CIX100 cleanliness inspection system is designed to meet the cleanliness requirements of modern industry and national and international directives. And with deep-learning AI technology, you can extend the possibilities of particle type identification.

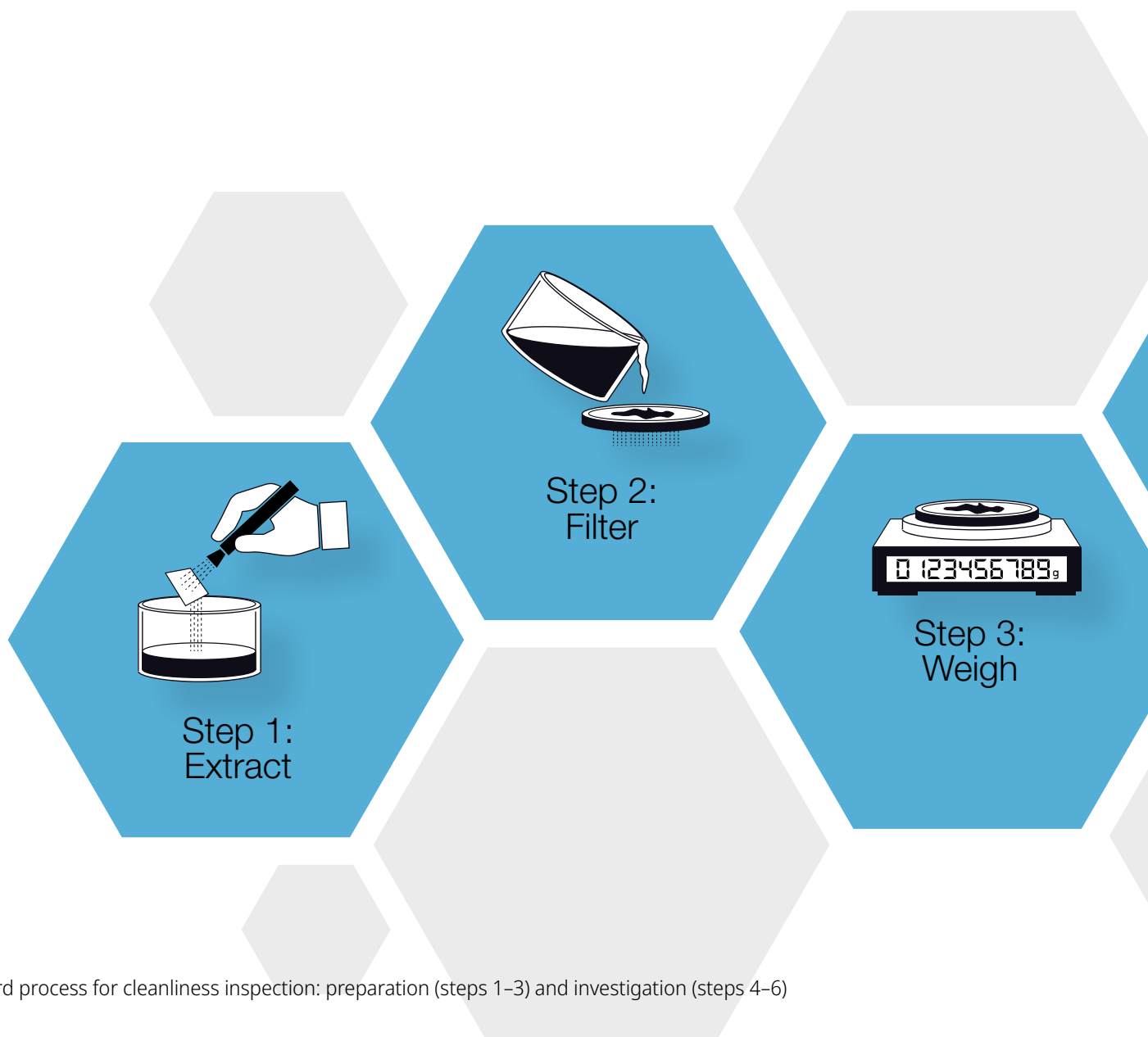

Standard process for cleanliness inspection: preparation (steps 1–3) and investigation (steps 4–6)

01

RELIABLE

Seamlessly integrated hardware and software result in a durable, high-throughput system that delivers reliable and accurate data.

02

INTUITIVE

Dedicated, easy-to-use workflows minimize user action and provide reliable data — independent of the operator and experience level. User-friendly tools make it easy to revise inspection data. For greater flexibility, the system supports a separate microscope mode with optional material analysis solutions.

03

FAST

The innovative all-in-one-scan solution enables scans with classification in reflective and non-reflective particles to be completed twice as fast as other inspection systems. Immediate feedback of counted and sorted particles facilitates fast decisions.

04

COMPLIANT

One-click reporting meets the requirements and methodologies set forth in international standards. Report customization (e.g., particle morphology), makes it easy to meet company standards.

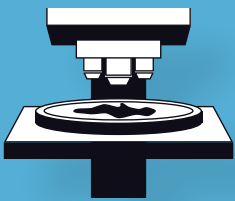

Step 4:
Inspect



Step 5:
Review



Step 6:
Results

Reliable Turnkey Solution

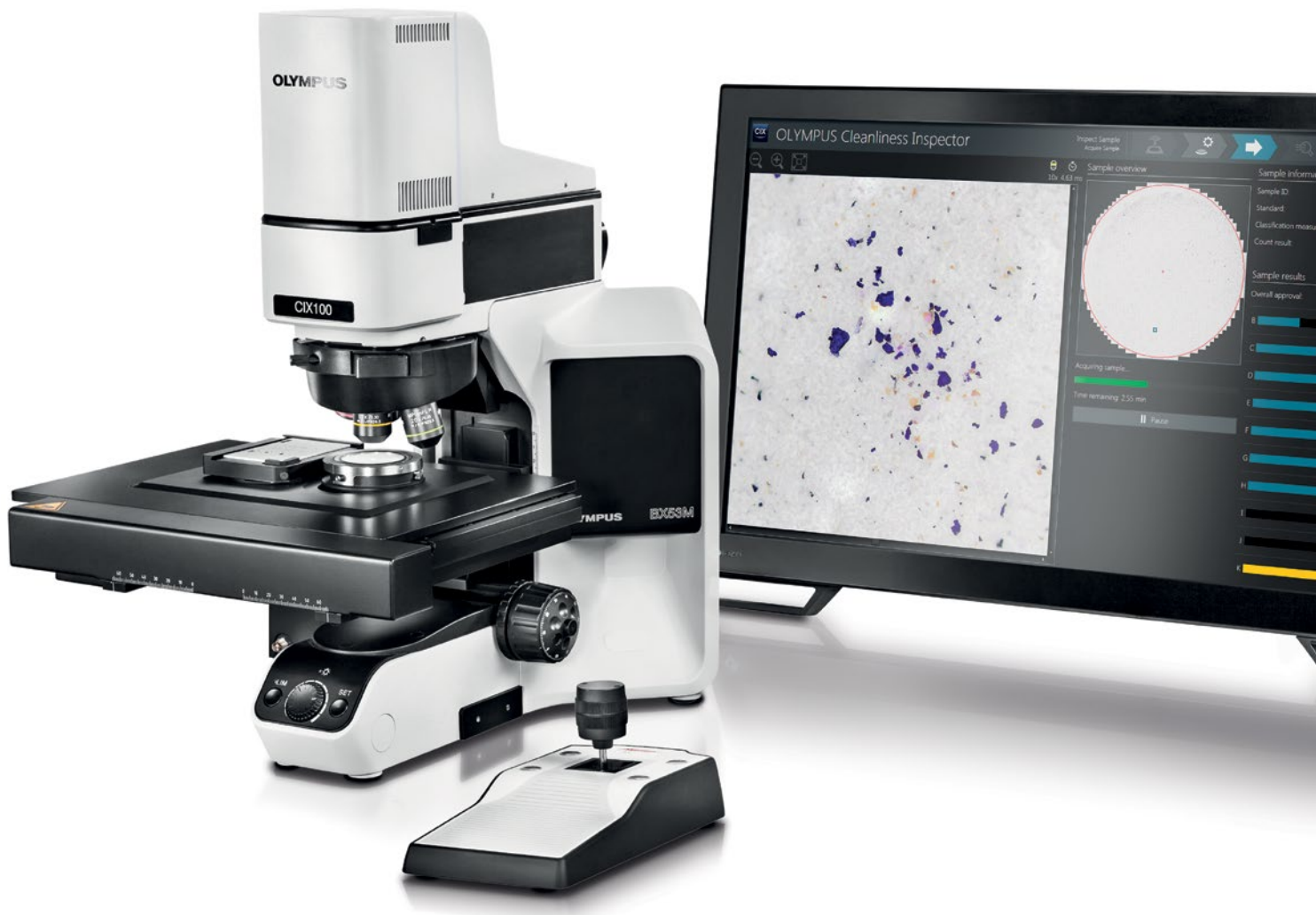

Automated and Accurate for High Reproducibility

The CIX100 system is a turnkey solution designed to meet the needs of automated cleanliness inspection. Each component is optimized for accuracy, reproducibility, repeatability, and seamless integration for reliable data in a high-throughput system. The system provides excellent optical performance for fast inspections of circular and rectangular inspection areas. Automation of critical tasks helps speed up inspections while minimizing human errors and the risk of contaminating the sample.

Excellent Optical Quality, Mechanical Stability, and Security

Our renowned UIS2 objectives and a high-resolution camera provide high optical performance and exceptional image quality for excellent measurement and analysis accuracy. A dedicated light source maintains a consistent color temperature optimized for cleanliness inspection. The optical path alignment, motorized nosepiece, and camera are protected by a cover to prevent accidental misalignments. For system and calibration stability, all moving parts have been eliminated from the optical light path. Critical parameters remain unchanged during routine inspection thanks to user rights management tools that limit inexperienced users to basic workflows.



UIS2 objectives provide optical performance for accurate analysis.



Protected illumination system and camera prevent accidental misalignments.

Regular System Verification

The automatic focus drive helps ensure reproducible positioning for straightforward reinvestigation of detected contaminants. The stage insert maintains a secured membrane position and features an additional insert for the integrated calibration tool or a second sample. The preconfigured and pre-calibrated system has reminders for automatic system self-checks with the integrated calibration slide that helps maintain regular system verification.



Integrated calibration standard helps maintain regular system verification.

Reproducibility and Repeatability

The cleanliness inspection workflow is easy, so even inexperienced operators can achieve accurate and repeatable results. The preconfigured and pre-calibrated system, user rights management, and regular system self-checks help ensure that the settings are correct for reproducible inspection data independent of the operator or system. As a result, multiple departments and sites can apply the same quality standards at different locations.

Sample Holders for Greater System Versatility

The CIX100 system supports various sample holders with either circular or rectangular inspection areas. This includes holders with white or black backgrounds for filter membranes with a diameter of 25 mm, 47 mm, and 55 mm; holders for tape lift sampling; holders with a flat surface for metallurgy applications; and holders for particle traps.



Circular sample holders with white and black backgrounds for filter membranes with diameters of 25 mm (left), 47 mm (middle), and 55 mm (right).



Sample holder for particle traps

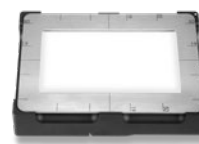

Sample holder for tape lift sampling

Intuitive Guidance

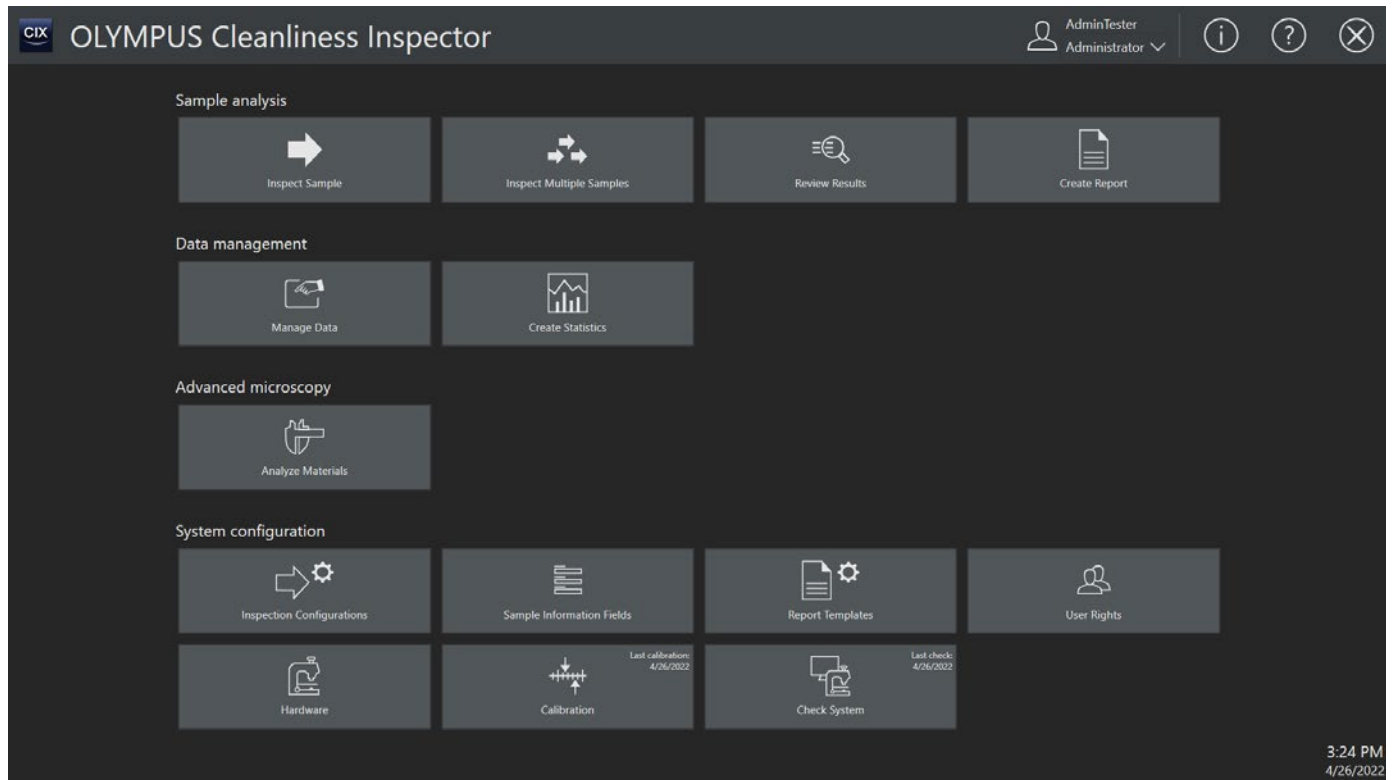

Maximum Productivity for Every Level of Experience

The CIX100 system delivers enhanced performance and productivity through the entire inspection process and makes technical cleanliness inspections easy for operators of every experience level. The software provides step-by-step guidance for the entire cleanliness inspection. Intuitive workflows and user rights management improve productivity and confidence in results while reducing cycle time, cost per test, and user errors. The result is a system optimized for high quality standards.

Guided Workflows

The interface has large buttons that are easy to click with a mouse or the touch-screen monitor. Step by step, the intuitive interface guides you through the complete inspection process. The result is a fast, productive workflow. With a click of a button, start scanning the membrane using the selected inspection configuration, review scanned or stored results (including validation), or create and print reports that comply with industry standards.



Intuitive workflow with large buttons that are easy to click with a mouse or the touch-screen monitor. Workflow steps from left to right: Mount Sample, Edit Settings, Run Inspection, Review Results, and Create Report.

Easy for Every Experience Level

The preconfigured, pre-calibrated system combined with an intuitive user interface makes cleanliness inspection simple for operators of every experience level. Easily generate results for industry standards using inspection configurations that specify the parameters for sample inspection, including rules for particle characterization and defining particle families and types. Reporting is just as easy—customize report templates for industry standards and your specific requirements.

Access to the inspection configurations		
Specification of settings for the standard		
Specification of settings for the particle family		
Specification of settings for the particle types		

Customize predefined international standards to your needs.

Advanced Microscopy

Microscope mode enables you to leave the dedicated cleanliness inspection workflow to perform microscopic imaging. Expand the microscope mode capabilities with optional material analysis solutions, such as Grain Intercept, Grain Planimetric, Cast Iron, Inclusion Worst Field, Layer Thickness, Dendrite Arm Spacing, Phase Analysis, Porosity, and Coating Thickness. As needed, these solutions can be extended with special functions customized to individual users or applications.

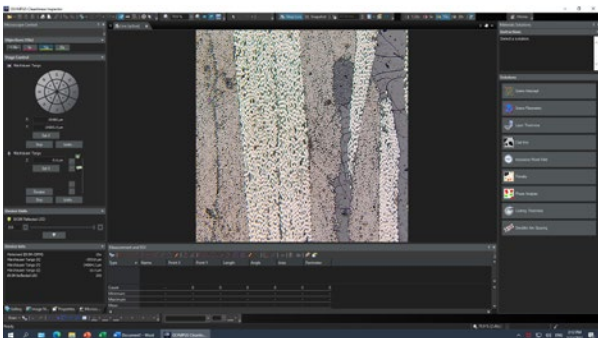

In microscope mode, the CI100 system can be used like a digital microscope.

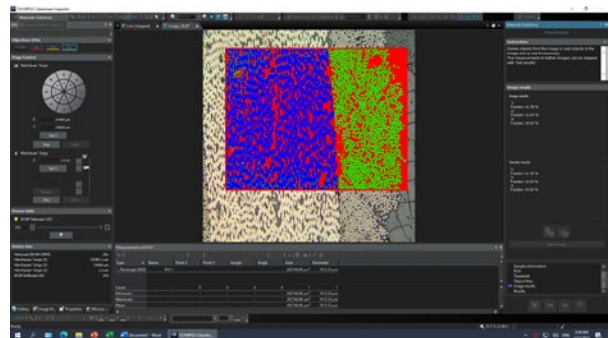

Expand the microscope mode capabilities with optional material analysis solutions.

User Rights Management Tools

Administrators can control which users have access to different parts of the system. This helps inexperienced users stay on task. Importantly, they also cannot influence critical parameters like calibration and data selected for the automatically generated report.

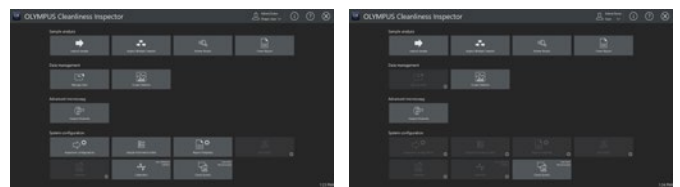

Administrators can access the complete system setup (left), while inexperienced users can be limited to basic workflows (right).

Fast Live Analytics and Reviews

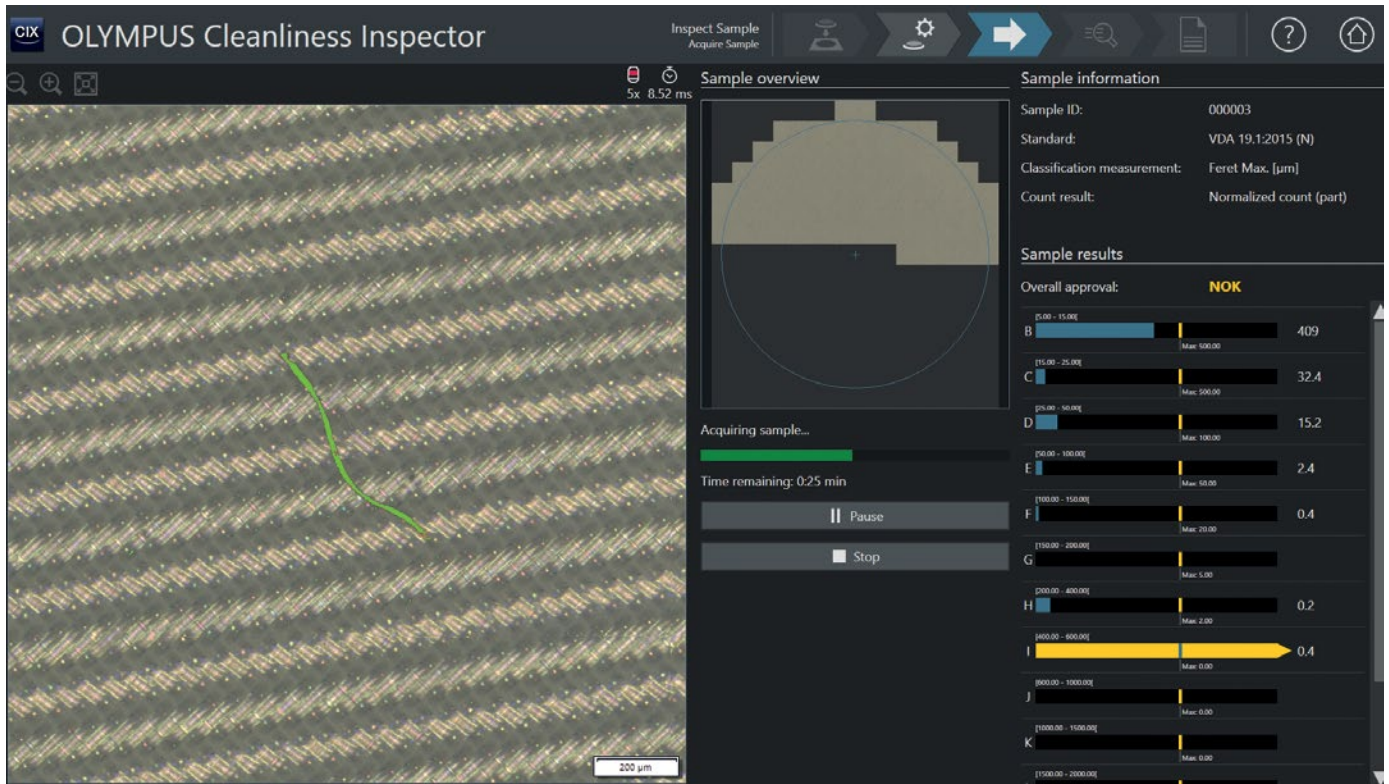

All Relevant Data Displayed in One Place

The CIX100 system offers high-performance image acquisition and precise live analytics of both reflective and non-reflective particles ranging from 2.5 µm up to 42 mm in a single scan thanks to a patented* polarization method. This all-in-one-scan solution enables scans to be completed twice as fast as the classical method (Inspector series). Counted and sorted particles are displayed live and sorted into size classes while the scan is acquired, supporting direct decision making and helping ensure a fast reaction time in case of a failed test.

*Patented number DE102013219181B4

All-in-One Scanning for High Throughput

An innovative polarization method based on wavelength separation and color detects both reflective (metallic) and non-reflective (nonmetallic) particles in a single scan. Integrated into the microscope frame, this high-throughput design enables scans to be completed twice as fast as the classical method (Inspector series) and eliminates moving components from the optical light path, such as the polarizer, which could negatively impact the system stability and lead to potentially incorrect results. This all-in-one-scan technique increases the number of inspected particles, reducing the cost per test and shortening the reaction time in case of a failed test.



The innovative illumination system separates reflective (metallic) and non-reflective (nonmetallic) particles in a single scan.

Intelligent Handling of Particles

The system offers live processing and classification of both small and large particles (2.5 µm up to 42 mm) according to international standards and automatically reconstructs images of large particles. Dark particles on a bright background and vice versa can be analyzed.

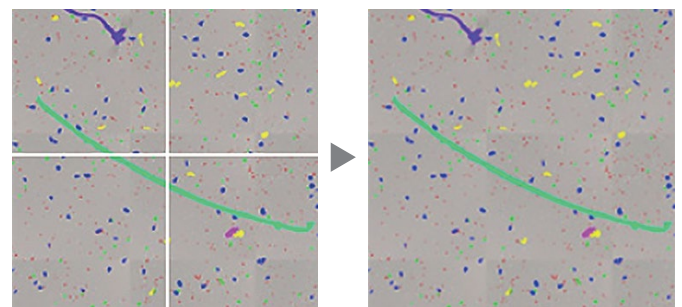

Large particles are automatically combined and analyzed.

Identification of Filter Coverage

The sample overview image can be created at the beginning of the sample inspection and displays the entire filter at low magnification. The overview image helps to identify filter coverage and particle clusters before the sample inspection starts. If the filter assignment is too high, the user is automatically alerted so they can act accordingly.

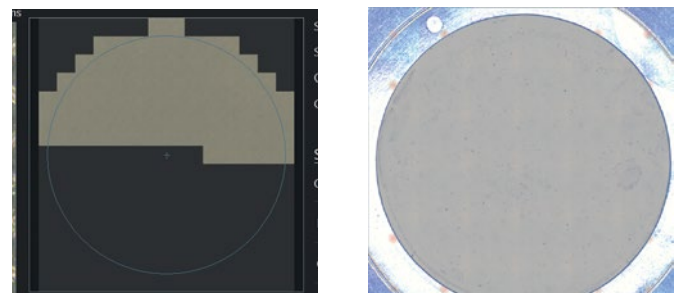

The overview image identifies filter occupancy and particle clusters.

Direct Result Feedback

Contaminants are automatically analyzed and sorted into size class bins defined by the selected standard and are color coded to clearly indicate which size class exceeds a predefined limit. Predefined acceptable particle counts per size classes are displayed, and the sample can be validated (OK) or rejected (NOK) even before the complete membrane is acquired. As required by the electric mobility and medical device industries, CIX100 v. 1.6 software enables you to evaluate the approval limits for individual particle types. An acoustic signal can be switched on when the approval reads NOK or the inspection is finished.

Analysis Beyond Classical Algorithms

With integrated TruAI deep-learning technology, the CIX100 system can analyze images beyond classical algorithms. You can apply a trained neural network to your samples for higher reproducibility and a more robust analysis. The TruAI solution enables you to discriminate between different types of detected particles, such as reflecting and non-reflecting.

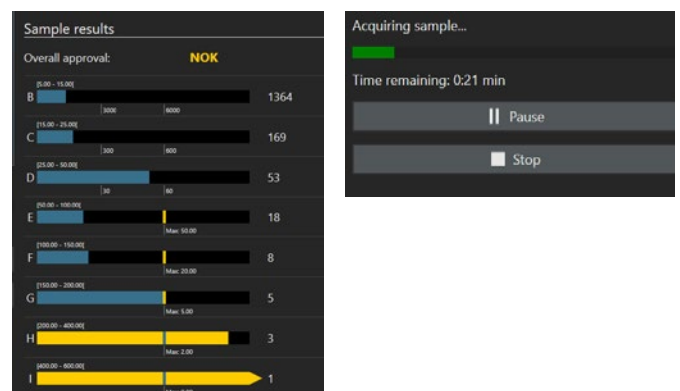

Live inspection results with the remaining time.

Data Insights for Fast Decision-Making

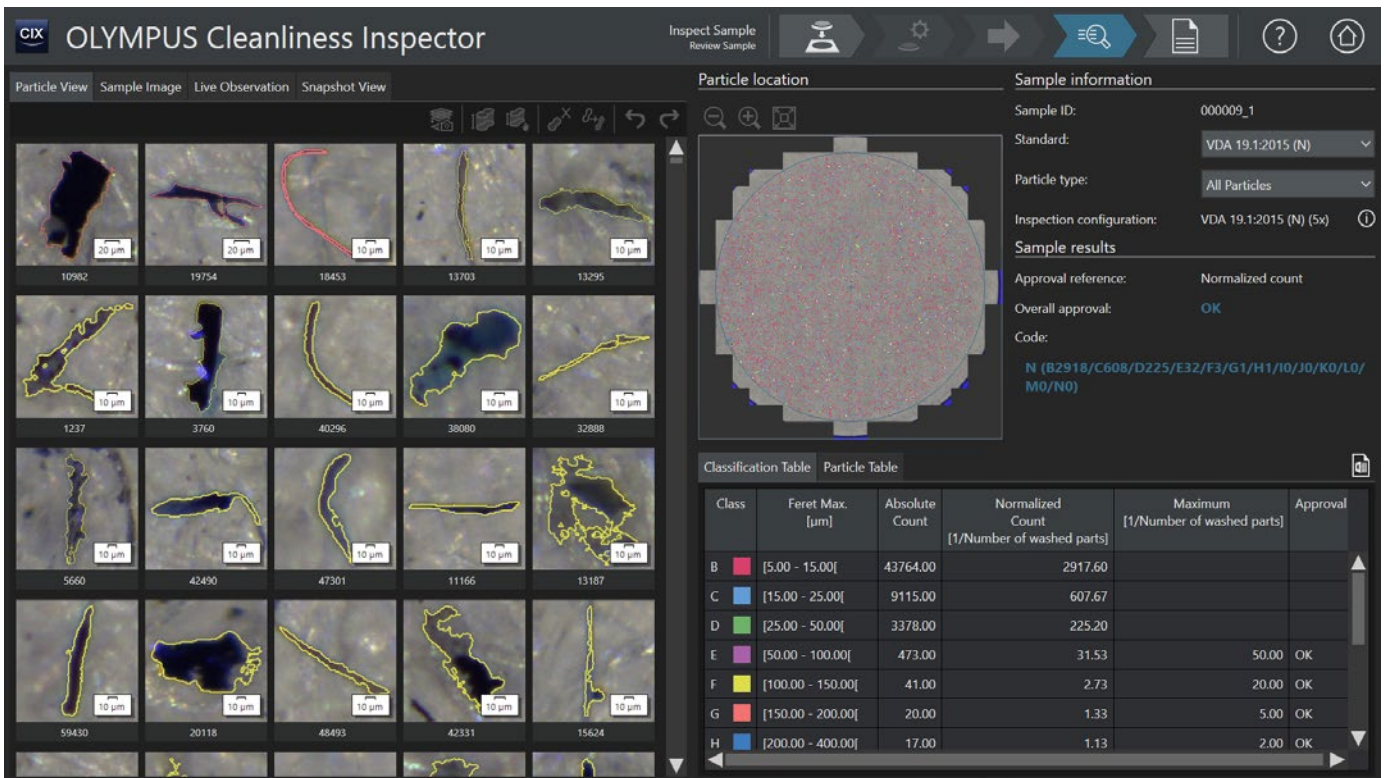

Flexible for Evaluation and Revision

The CIX100 system combines powerful, easy-to-use tools to revise inspection data with a fast, guided particle review. The one-click reclassification function provides flexibility and supports international standards. Thumbnail images of every contaminant detected by the system are linked with dimensional measurements, making it easy to review the data. Retrieving a contaminant's information is simple. During the review process, the results are updated and displayed automatically in all views and size classification bins. This saves time with clear representations of all relevant inspection results.

Inspection Data at a Glance

All particles, classification tables, the overall cleanliness code, the particle location, and the standard used appear in one view for efficient analysis. Thumbnail images of all particles, or a selected particle subset, are sorted by size. Contaminants are linked with their locations and dimensions, so selecting a thumbnail automatically drives the system to this contaminant for further analysis or post processing. Classification and particle tables show the results according to the selected standard. The component cleanliness code (CCC) and the approval limit are displayed according to the inspection task. The results and the CCCs calculated from them are displayed as required and can be limited to a selection of particle types.

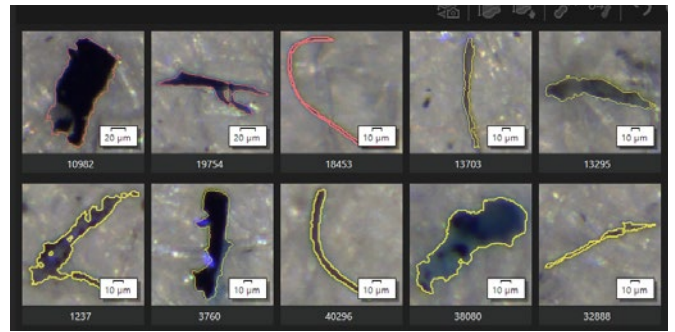

Selecting a thumbnail automatically drives the system to this contaminant.

Review, Revise, and Recalculate

A manual review of the results is recommended during technical cleanliness inspection. The software offers various interactive functions to correct the particle data if necessary. The system can store all inspection data and offers fast renormalization and evaluation in these situations. No second scan of the specimen is necessary. The system also offers powerful software tools like delete, split, and merge to make revising the data simple.

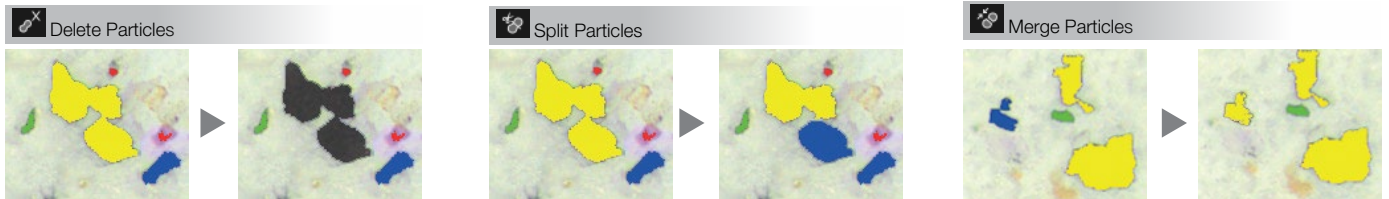

Powerful software tools make it easy to revise inspection data during the review step.

Trend Analysis

Data statistical analysis enables you to compare sample results and run a trend analysis. For streamlined data review, the system displays charts and tables to illustrate trends over time. View the data within the software or export it into a file format for documentation and further analysis.

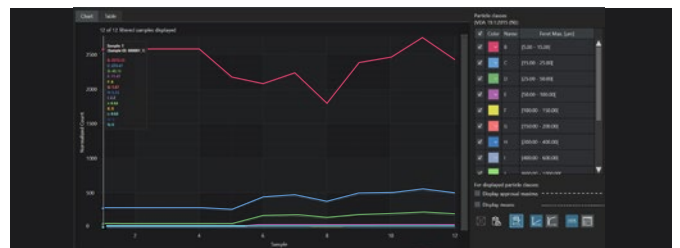

Trend analysis shows changes in the measurement data over time. This data review feature can be used as a part of quality assurance.

Height Measurement Solution

The CIX100 system's extended focus imaging (EFI) function captures images of contaminants/particles whose height extends beyond the objective's depth of focus and stacks them together to create an all-in-focus image. The system can be further enhanced with a height measurement solution, comprised of a 20X objective and special software, to fulfill the VDA 19 requirements for height measurements. For selected particles, the height measurement is performed either automatically or manually. The calculated height value is listed as an additional data field in the results sheet.

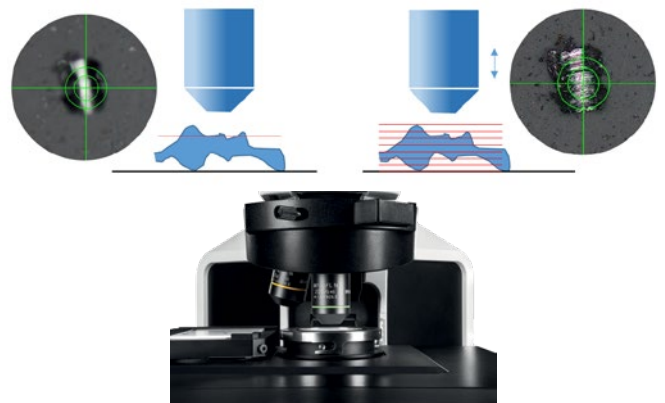

Compliant Results and Documentation



Efficient Report Creation

Smart, sophisticated reporting tools enable easy one-click digital documentation of inspection results. Reports are based on predefined templates that comply with industry standards and can be easily modified to meet the needs of your company. Export the results to Microsoft Word or directly export as a PDF for easy data sharing over email. Report templates and data sharing tools help inexperienced operators quickly create and distribute accurate, professional documentation. The CIX100 system can also archive reports and data for record keeping and trend analysis.

Smart, Professional Variability

Generate high-quality, professional reports with predefined templates based on further inspections. Reports are performed according to the methodologies set forth in international standards. With just one click, create analytical reports that comply with the standard used during analysis. Easily adapt templates and reports to meet company regulations.



Reports can be adapted to individual needs.

Easy Data Export

Exporting a report is as easy as clicking your mouse. Create the reports in Microsoft Word or PDF format, depending on your preference, and easily export the particle and classification results and trend analysis to Microsoft Excel. Report file sizes are optimized for efficient data sharing.

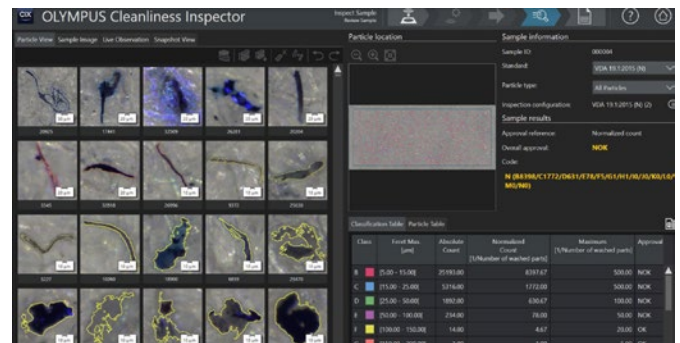

Individual images of contaminants can be taken and processed for manual measurement confirmation and improved documentation.

Long-Term Data Storage

Quickly access all the archived samples, as well as their associated data and reports for revision or distribution. All inspection data and reports are automatically saved and archived for a certain period of time.



With long-term data storage, records can be accessed to justify a decision years later.

Hardware

Microscope	CIX100	Motorized focus	<ul style="list-style-type: none"> • Coaxial motorized fine focus with three-axis joystick • Focus stroke 25 mm • Fine stroke 100 μm / rotation • Maximum height of stage holder mounting: 40 mm • Focus speed 200 $\mu\text{m}/\text{sec}$ • Software autofocus enabled • Customizable multipoint focus map
		Illumination	<ul style="list-style-type: none"> • Built-in LED illumination • Innovative illumination mechanism with simultaneous detection of reflecting and non-reflecting particles • Light intensity controllable by software
		Imaging device	<ul style="list-style-type: none"> • Color CMOS USB 3.0 camera • On chip pixel size 2.2 μm x 2.2 μm
		Sample size	<ul style="list-style-type: none"> • The standard sample is a filter membrane of diameter 47 mm. Filter holders with 25 mm or 55 mm membrane diameter or customized sample holders can be provided.
Nosepiece	Motorized type	Motorized nosepiece	<ul style="list-style-type: none"> • Six-position motorized nosepiece with 3 UIS2 objectives already installed • PLAPON 1.25X used for preview • MPLFLN 5X used for detecting particles bigger than 10 μm • MPLFLN 10X used for detecting particles bigger than 2.5 μm
		Software controlled	<ul style="list-style-type: none"> • The image magnification and relation between pixel and size is known at every moment. • Selected objectives are used at selected steps in the measurement process, objectives are automatically positioned.
Stage	Motorized stage X,Y	Motorized stage X,Y	<ul style="list-style-type: none"> • Stepper motors controlled movement • Maximum range: 130 mm x 79 mm • Maximum speed: 240 mm/s (4 mm ball screw pitch) • Repeatability: < 1 μm • Resolution: 0.01 μm • Controllable with three-axis joystick
		Software controlled	<ul style="list-style-type: none"> • Scanning speed depends on the used magnification, at 10x the scanning time is typically less than 10 minutes. • Stage alignment is performed at factory assembly.
	Specimen holder	Sample holder	<ul style="list-style-type: none"> • Membrane holder is specially designed to avoid an unwanted rotation of the membrane during mounting. • The membrane is mechanically flattened by the membrane holder. • No tool is needed to fix the cover. • Sample holder for filter membranes with diameters of 25 mm, 47 mm, and 55 mm • Sample holder for particle traps, particle trap consumables, and tape lift sampling.
		Particle Standard Device (PSD)	<ul style="list-style-type: none"> • Reference sample used to validate the system measurement. • Sample used in the check system's built-in function for controlling the proper function of the CIX. • The PSD is always assigned slot 2 on the stage.
	Stage insert	2-position stage insert	<ul style="list-style-type: none"> • Stage insert dedicated to the right positioning of the sample holder and the PSD
Controller	Workstation	High-performance pre-installed workstation	<ul style="list-style-type: none"> • HP Z4G4, Windows 10-64 bit Professional (English) • 16 GB RAM, 256 GB SSD and 4 TB data storage • 2 GB video adaptor • Microsoft Office 2019 (English) installed • Networking capabilities, English qwerty keyboard, optical mouse 1000 dpi
		Add-in boards	<ul style="list-style-type: none"> • Motorized controller, RS232 serial, and USB 3.0
		Language selection	<ul style="list-style-type: none"> • Operating system and Microsoft Office default language can be changed by the user
	Touch panel display	23-inch slim screen	<ul style="list-style-type: none"> • Resolution: 1920 x 1080, optimized for use with the CIX software
Power		Rating	<ul style="list-style-type: none"> • AC adapter (2), controller and microscope frame (4 plugs necessary) • Input: 100-240V AC 50/60Hz, 10 A
		Power consumption	<ul style="list-style-type: none"> • Controller: 700 W; Monitor: 56 W; Microscope: 5.8 W; Control Box 7.4 W • Total: 769.2 W
Drawing		Dimensions (W x D x H)	Approx. 1300 mm x 800 mm x 510 mm (51.2 in. x 31.5 in. x 20 in.)
		Weight	44 kg (97 lb)

System Environment Limitations

Normal use	Temperature	10 °C to 35 °C (50 °F to 95 °F)
	Humidity	30 to 80%
For safety regulations	Environment	Indoor use
	Temperature	5 °C to 40 °C (41 °F to 104 °F)
	Humidity	<ul style="list-style-type: none"> • Maximum 80% (up to 31 °C [88 °F]) (no condensation) • Usable humidity declines linearly as temperature rises above 31 °C (88 °F) • 70% (34 °C [93 °F]) to 60% (37 °C [98 °F]) to 50% (40 °C [104 °F])
	Altitude	Up to 2,000 m (6,562 ft)
	Level of horizon	Up to $\pm 2^\circ$
	Power supply and voltage stability	$\pm 10\%$
	Pollution level (IEC60664)	2
	Overall voltage category (IEC60664)	II

Software

Software	CIX-ASW-V1.6	<ul style="list-style-type: none"> Dedicated workflow software for technical cleanliness inspection
Languages	GUI	<ul style="list-style-type: none"> GUI: English, French, German, Spanish, Japanese, Simplified Chinese and Korean
	Online help	<ul style="list-style-type: none"> Online help: English, French, German, Spanish, Japanese, Simplified Chinese and Korean
License management		<ul style="list-style-type: none"> Software license activated by license card (already activated at installation)
User management		<ul style="list-style-type: none"> System can be connected to a network for domain administration. The range of functions can be selected depending on the authenticated user.
Live image	Display in color mode	<ul style="list-style-type: none"> Particles are analyzed with blue color for metallic ones and original color for non-metallic ones.
	Window fit method	<ul style="list-style-type: none"> The image is always displayed in a full view.
	Live detection	<ul style="list-style-type: none"> Particles are analyzed as soon as they are captured for improved speed. User can stop the process if the measurement result is not good.
	Live classification	<ul style="list-style-type: none"> Particles are classified as soon as they are detected. Particle size classes are identified on the user interface during the live acquisition.
Image capture and manual measurements	Microscope mode	<ul style="list-style-type: none"> Microscope mode can be accessed for microscopic imaging. Optional access to material analysis solutions (not included).
	Collecting user snapshots	<ul style="list-style-type: none"> In the review mode, it is possible to acquire single images from any position on the sample, as well as acquire images in the live observation mode (from the direct image) or the sample view mode (from recorded data). Images can be stored in .tif, .jpg or .png files with a standard resolution of 1000 × 1000 pixels. Snapshots can be linked to a detected particle and later used in the analytical report. Particle snapshots can be automatically acquired in EFI (Extended Focus Imaging) mode. Recordings taken in EFI mode can be used in the analytical report.
Hardware control	Manual measurements	<ul style="list-style-type: none"> It is possible to perform arbitrary distance measurements on an acquired snapshot. Arbitrary measurements can be renamed and the annotation can be colored. Arbitrary measurements and scale bar are burned in the image when stored.
	XYZ motorized stage	<ul style="list-style-type: none"> Joystick operation and control by software Inspection of circular and rectangular sample areas Automatic or manual repositioning on selected particles
	Motorized nosepiece	<ul style="list-style-type: none"> Selection by software only
Check system	Motorized focusing	<ul style="list-style-type: none"> Control by joystick Software autofocus available Predictive autofocus using multipoint focus map
	System verification	<ul style="list-style-type: none"> System is verified by measuring the Particle Standard Device parameters. OK or NOK quality value is produced.
Technical cleanliness standards	Selectable objective	<ul style="list-style-type: none"> Check system can be performed only with the working objective (one objective should be selected at least). Check system is performed with either 5X or 10X objectives, or both.
	Supported standards:	<ul style="list-style-type: none"> ASTM E1216-11:2016, ISO 4406:2021; ISO 4407:1999; ISO 4407:2002 [Cumulative and Differential]; ISO 11218:2017; ISO 12345:2013; ISO 14952:2003; ISO 16232-10:2007 (A, N, and V); ISO 16232:2018 (A, N, and V); ISO 21018:2008; DIN 51455:2020 [70% and 85%]; NAS 1638:1964; NF E 48-651:1986; NF E 48-655:1989; SAE AS4059:2020; VDA 19.1:2015 (A, N, and V); VDA 19.2:2015
	Fully compliant to VDA 19.1 and VDA 19.2 recommendations	<ul style="list-style-type: none"> Thresholds are automatically set at the VDA recommend values.
	Identification of particle types	<ul style="list-style-type: none"> Particles can be classified by particle types (non-reflecting, reflecting, fibers, or others). Possibility to type the detected particles based on deep-learning (AI) technology.
Inspection configuration	Customized standards	<ul style="list-style-type: none"> User defined standards can be defined easily. Particle measurement parameters include filiform particle size and compact particle size according to DT 55-83.
	Inspection configuration	<ul style="list-style-type: none"> The system enables users to load, define, copy, rename, delete, and save an inspection configuration. Standards and report templates can also be stored and recalled. It is possible to invert the detection threshold to detect bright particles on a dark background. It is possible to acquire several samples in a sequence. It is possible to set approval limits for individual particle types It is possible to extended by CCCs for the different particle types Each sample can be inspected with a particular configuration.
Particle tile view	Displays the detected particles in tile for improved navigation	<ul style="list-style-type: none"> Every particle position can be retrieved by double click on the tile. Every tile is adapted to the actual particle size.
Store the full membrane	The complete filter is stored	<ul style="list-style-type: none"> Offline analysis enables users to select a different standard for the results display.
Data export	Save data	<ul style="list-style-type: none"> Inspection data can be exported to an Excel (.xlsx) table. All tables available in the software can also be exported into Excel.
Trend analysis	Trend analysis over several samples (Built-in SQC tool)	<ul style="list-style-type: none"> Data per size classes can be displayed. Data can be plotted over time, sample, measurement ID. Scale can be selected (log-normal, log-log). Data points can be extracted and exported to spreadsheet. Table can be exported in Q-DAS (.dfg) format. All tables available in the software can also be exported into Excel.
Particle editing	Particles can be edited during the revision process.	<ul style="list-style-type: none"> Add, delete, merge, or split particles with lines or polyline. Change the particle type.
Dynamic reports	Professional analytical reports can be produced by using Microsoft Office 2019 Home and Business (license not included)	<ul style="list-style-type: none"> Templates are precisely customizable Users can choose to put the pictures after the table or keep all pictures grouped together when selecting different particle families.

Optional Solution CIX-S-HM

Height Measurements	Automatic or manual height measurement of selected particles	<ul style="list-style-type: none"> Optional software solution that drives the motorized focus drive from top to bottom of selected particles. The particle height is then processed from the difference between the top and the bottom Z coordinate. Includes an additional objective lens (20X MPLFLN) and a license card that needs to be activated at installation. It is possible to select multiple particles for automatic height measurement at several positions.
---------------------	--	--

Environmental Law and Regulations

Europe	Low Voltage Directive 2014/35/EU
	EMC Directive 2014/30/EU
	RoHS Directive 2011/65/EU
	REACH Regulation No. 1907/2006
	Packaging and Packaging Waste Directive 94/62/EC
	WEEE Directive 2012/19/EU
USA	Machinery Directive 2006/42/EC
	UL 61010-1:2010 Edition 3
Canada	FCC 47 CFR Part15 SubPartB
	CAN/CSA-C22.2 (No. 61010-1-12)

Australia	Radio communications Act 1992, Telecommunications Act 1997
	Regulation on Energy conservation AS/NZS 4665-2005
Japan	Electrical Appliances and Material Safety Act (PSE)
Korea	Electrical Appliances Safety Control Act
	Regulation on Energy Efficiency Labeling and Standards
China	Regulations for EMC and Wireless Telecommunication (Notice 2913-5)
	China RoHS
	China PL Law
	Regulation for Manuals

Dimensions

CIX100

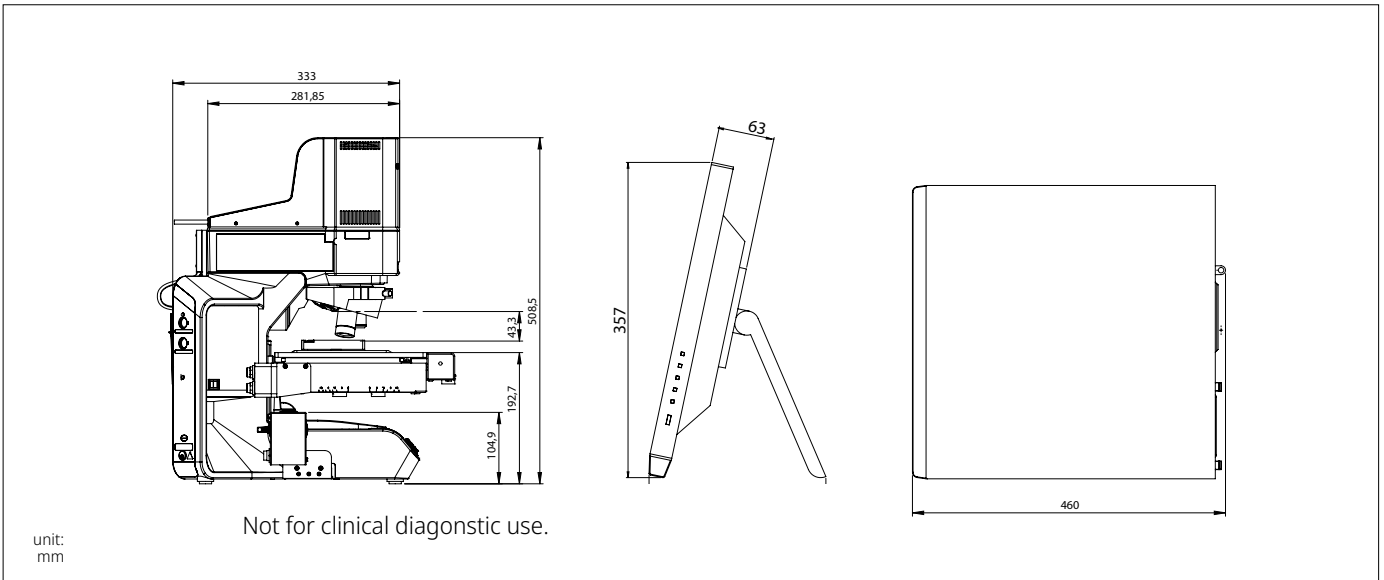
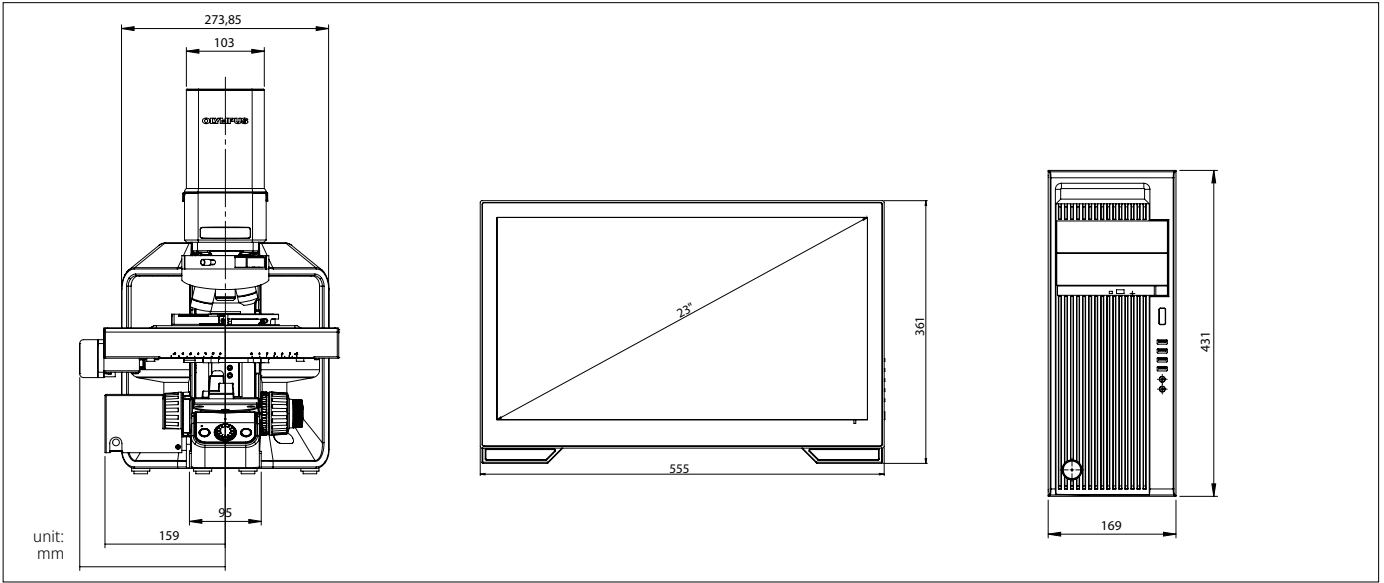

- EVIDENT CORPORATION is ISO14001 certified.
 - EVIDENT CORPORATION is ISO9001 certified.
- All company and product names are registered trademarks and/or trademarks of their respective owners.
- Images on the PC monitors are simulated.
 - Illumination devices for microscope have suggested lifetimes. Periodic inspections are required. Please visit our web site for details.
 - Specifications and appearances are subject to change without any notice or obligation on the part of the manufacturer.

EvidentScientific.com

EVIDENT

EVIDENT CORPORATION
Shinjuku Monolith, 2-3-1 Nishi-Shinjuku, Shinjuku-ku, Tokyo 163-0910, Japan

OLYMPUS