

INDUSTRIAL

Industrial Scanners and Accessories





EVIDENT



EVIDENT Phased Array Inspections
Probe Catalog

Phased Array Probes and Wedges

- Solution-Specific Probes
- Angle Beam Probes
- Immersion Probes
- Integrated Wedge Probes
- Curved Array Probes
- Wedges

EVIDENT **Ultrasonic Transducers**
WEDGES, CABLES, TEST BLOCKS





- Contact
- Dual Element
- Angle Beam
- Shear Wave
- Delay Line
- Protected Face
- Immersion
- TOFD
- High Frequency
- Atlas European Standard

Scanners are usually not supplied with probes and wedges. For phased array probes and wedges, refer to the Phased Array Probes and Wedges catalog; for UT probes and wedges, refer to the Ultrasonic Transducers catalog.

Table of Contents

Scanner Technical Matrix	4
Scanner Application Matrix	4
Scanner Encoder Connector Compatibility	4
Manual One-Axis Scanners	5
VersaMOUSE™ – Manual One-Line Indexer Scanner	5
Mini-Wheel™ Small Footprint Encoder	6
HST-X04™ TOFD Manual Scanner	6
Wire Encoder	6
Universal Holder	6
HST-Lite Scanner for TOFD Weld Inspection	7
COBRA™ Scanner for Weld Inspection of Small-Diameter Pipes	8
HSMT-Compact™ Scanner for Girth Weld Inspection	10
HSMT-Flex™ Scanner for Girth Weld Inspection	11
AxSEAM™ Long Seam Weld Scanner	12
RollerFORM™ Phased Array Wheel Probe	14
HydroFORM™ Scanner for Corrosion Mapping	16
FlexoFORM™ Scanner for Pipe Elbow Inspection	18
Motorized One-Axis Scanner	20
WeldROVER™ Scanner for Weld Inspection	20
Motorized Two-Axis Scanner	22
MapROVER™ Scanner for Corrosion Mapping	22
SteerROVER™ Scanner for Weld Inspection and Corrosion Mapping	24
Manual Two-Axis Scanner	26
ChainSCANNER™ Solution for Pipe Inspection	26
MapSCANNER™ Solution for Corrosion Mapping	28
GLIDER™ Scanner for Composite Inspection	29
Accessories	
Pulsers and Preamplifiers	30
TRPP 5810™ Pulser/Preamplifier for TOFD Inspection	30
5682 Preamplifier for TOFD Inspection	30
Cables and Adaptors	31
Umbilical Cables	31
Adaptors and Extension Cables	32
InterBox	33
Indexer Clicker	33
Couplant Feed Units	34
CFU03 and CFU05 Electric Couplant Feed Units	34
Manual Couplant Feed Units	34
Yokes	35
Aqualene Elastomer Couplant	35

Scanners and Accessories

The capacity to accurately position probes according to the surface being inspected greatly influences inspection quality. Depending on the application, constraints can arise that make probe positioning difficult. Olympus offers a wide range of industrial scanners and accessories to assist inspectors in their work while providing optimal data acquisition. Some of the applications covered by our scanner product line are weld inspection, corrosion mapping, and aerospace. Supported technologies include phased array, conventional ultrasonic, time-of-flight diffraction (TOFD), eddy current, and eddy current array. Scanner configurations include one- or two-encoded axes and manual or motorized options.

Scanner Technical Matrix

Inspection Technology	One-Axis Scanner		X-Y Scanner	
	Manual	Motorized	Manual	Motorized
Conventional Ultrasonics	HSMT-Compact™ HSMT-Flex™ HST-X04™	WeldROVER™	ChainSCANNER™ GLIDER™	MapROVER™ SteerROVER™
TOFD	HST-X04 HST-Lite HSMT-Compact HSMT-Flex AxSEAM™	WeldROVER	ChainSCANNER	SteerROVER
Phased Array	Mini-Wheel™ Wire Encoder VersaMOUSE™ RollerFORM FlexoFORM HydroFORM™ COBRA™ HSMT-Compact HSMT-Flex AxSEAM™	WeldROVER	Mini-Wheel + Indexer-Clicker VersaMOUSE RollerFORM™ ChainSCANNER MapSCANNER™ GLIDER FlexoFORM	MapROVER SteerROVER
Phased Array and TOFD	HSMT-Compact HSMT-Flex AxSEAM™	WeldROVER	ChainSCANNER	SteerROVER

Scanner Application Matrix

Application	Scanner Model	Mini-Wheel	Wire Encoder	VersaMOUSE	COBRA	HST-X04	HST-Lite	HSMT-Compact	HSMT-Flex	AxSEAM	WeldROVER	ChainSCANNER	MapROVER	SteerROVER	HydroFORM	FlexoFORM	MapSCANNER	GLIDER	RollerFORM
		Weld		●	●	●	●	●	●	●	●	●	●	●	●	●			
Corrosion		●	●	●								●	●	●	●	●	●	●	
Aerospace/ Wind Blade		●	●	●														●	●

Scanner Encoder Connector Compatibility

Except when stated otherwise, scanners sold after July 2013 come standard with a LEMO® connector that is compatible with current generation OmniScan™ and FOCUS instruments. For use on a different instrument, an optional adaptor is required.

Required Encoder Cable Adaptor

Instrument	Scanner Connector	
	LEMO (From 07/2013)	DE15 (Prior to 07/2013)
OmniScan MX1	Omni-A-ADP27 [U8780329]	N.A.
TomoScan FOCUS LT	C1-LF-BXM-0.3M [U8769010]	C1-DE15F-BXM-0.30M [U8767107]
Current OmniScan and FOCUS Instruments	N.A.	Omni-A2-ADP20 [U8775201]

Manual One-Axis Scanners

VersaMOUSE™ - Manual One-Line Indexer Scanner

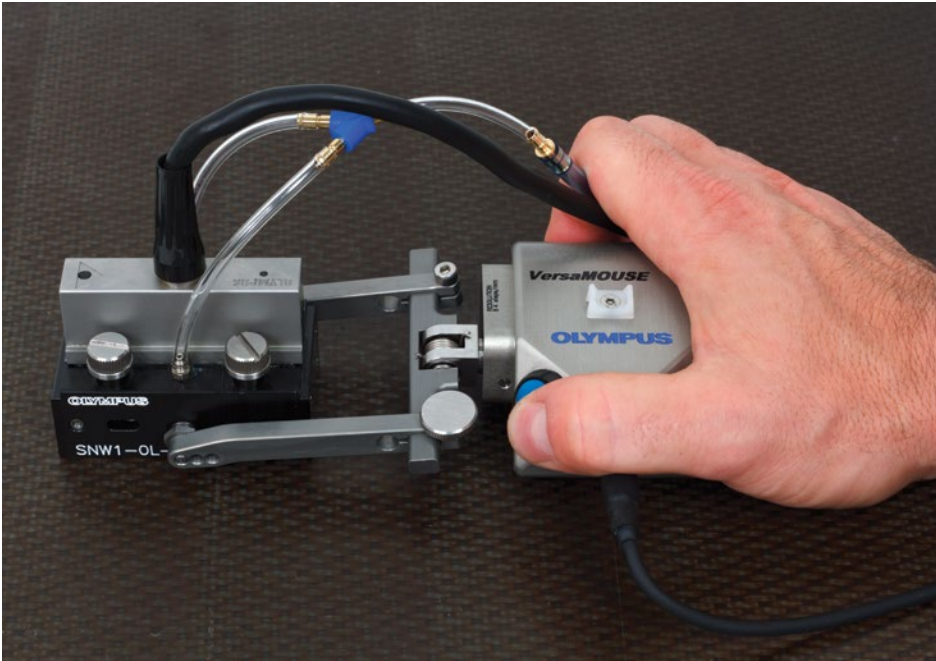

The VersaMOUSE™ scanner is designed for linear encoded scans with a phased array probe. The integrated indexing button makes it ideal for 2D mapping applications such as CFRP flat panel and corrosion inspections. The VersaMOUSE scanner can perform an encoded one-line scan followed by indexing the position in the perpendicular direction. Another one-line scan can then be performed and juxtaposed to the previous scan. This process is repeated to produce a complete 2D map of the area of interest.

The scanner's adjustable yoke is easy to set up on an IHC-type wedge using standard attachment holes. The spring-loaded system is optimized to offer the lowest clearance possible. The yoke is attached to the scanner using a quick-connect system, which keeps the probe either parallel or at a 90° skew to the scan axis.

The encoder's wheels are designed to resist slippage on wet surfaces. The rugged construction makes this scanner an affordable, reliable solution for all phased array inspections performed with a single probe. For even better stability on ferromagnetic surfaces, an optional magnetic wheel package is available.

Specifications

Probe Holder Position	Length in Scan Axis (mm)	Width (mm)	Height (mm)	Weight (kg)
Front	170	80	42	0.4
Side	80	152	42	0.4



An easily clipped and spring-loaded yoke that can be positioned with a 90° skew.

Features

- › Encoded linear scan (one axis) for phased array inspection.
- › Integrated clicker button for indexing enabling 2-D mapping.
- › Adjustable fork for easy and fast installation of multiple wedge dimensions.
- › Two rubber wheels that remain in contact with the surface for maximum adherence.
- › An easily clipped and spring-loaded yoke that can be positioned with a 90° skew.
- › Encoder resolution: 8.4 steps/mm.
- › Durable aluminum body and waterproof construction.

Standard Inclusions

- › 2.5 m encoder cable.
- › One adjustable PA yoke (width: 65 mm, length: 65 mm with 8mm and 5mm buttons).
- › Carrying case.

Note: Probes and wedges are not included with the scanner.

Options

Magnetic Wheels package

Optional magnetic wheels provide maximum adherence and improved stability on ferromagnetic surfaces.

P/N: Versa -A-MagWheel [U8775247]



VersaMOUSE and RexoFORM scanners for corrosion inspection.

Mini-Wheel™ Small Footprint Encoder



The Mini-Wheel™ encoder is compatible with the HST-X04 scanner as well as Olympus standard PA wedges. It can be mounted directly on the wedges using the included bracket kit or using Evident's universal holder for increased versatility and ease of use.

Magnetic Wheel (standard with universal holder package)

Maximum adherence on ferromagnetic surfaces.

P/N: ENC1-A-MagWheel-V2 [U8775290]

Rubber Wheel (standard on stand-alone ENC1)

Ideal for nonferromagnetic surfaces with temperatures up to 150°C.

P/N: ENC1-A-Pwheel [Q1500046]

Mounting Bracket Kit (included in stand-alone ENC1)

Used to mount the Mini-Wheel encoder directly on a wedge.

P/N: ENC1-BRACK [U8775120]

Features

- › Waterproof (IP68).
- › Sealed bearing for long-lasting smooth wheel rotation.
- › Spring-loaded attachment system.
- › Threaded holes for alternative mounting.

HST-X04™ TOFD Manual Scanner

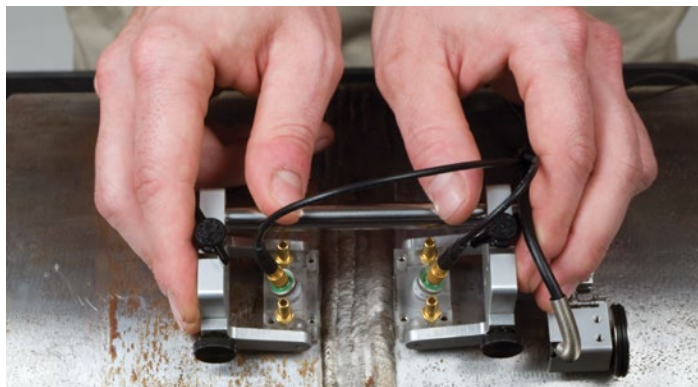

Wire Encoder

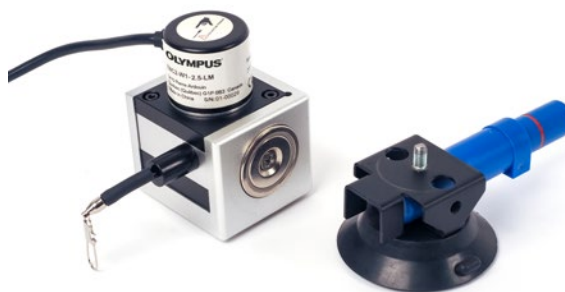

The wire encoder features a robust 1-meter-long stainless steel wire as well as two types of mounting bases. Easily switch between the magnetic base to quickly install the encoder on any ferromagnetic surface and the suction cup base to mount it on other smooth surfaces. Being attached directly to the surface, the wire encoder enables precise and repeatable positioning as well as minimum impact on freedom of scanning.

Universal Holder

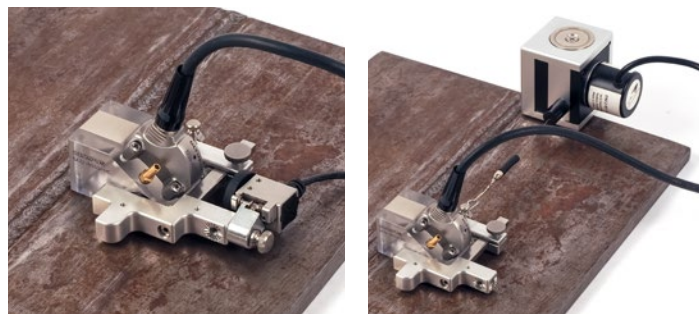

Offering three mounting orientations, the universal holder enables you to quickly attach the Mini-Wheel encoder or the wire encoder to most phased array wedges without requiring any tools. Use it to perform circumferential or axial encoded scanning for angle beam or 0-degree inspections. You can also attach phased array probes directly to the universal holder to perform contact inspection when needed.

The HST-X04™ TOFD manual scanner offers an efficient, low-cost weld inspection solution. It can be ordered in 3 different kits:

HST-X04: Mini-Wheel™ encoder, 2x 10 MHz, 3 mm TOFD probes, 2x 5 MHz, 6 mm TOFD probes, 2x ST1-45L-IHC, 2x ST1-60L-IHC, 3x ST1-70L-IHC, 2x 5 m LEMO 00 to Microdot UT cables, 2x LEMO 00 to BNC adapters

HST-X04-SCN: TOFD scanner and Mini-Wheel encoder only

HST-X04-PA: Includes a Mini-Wheel encoder as well as scanner frame holding two 40 mm wide PA probes.

HST-Lite Scanner for TOFD Weld Inspection

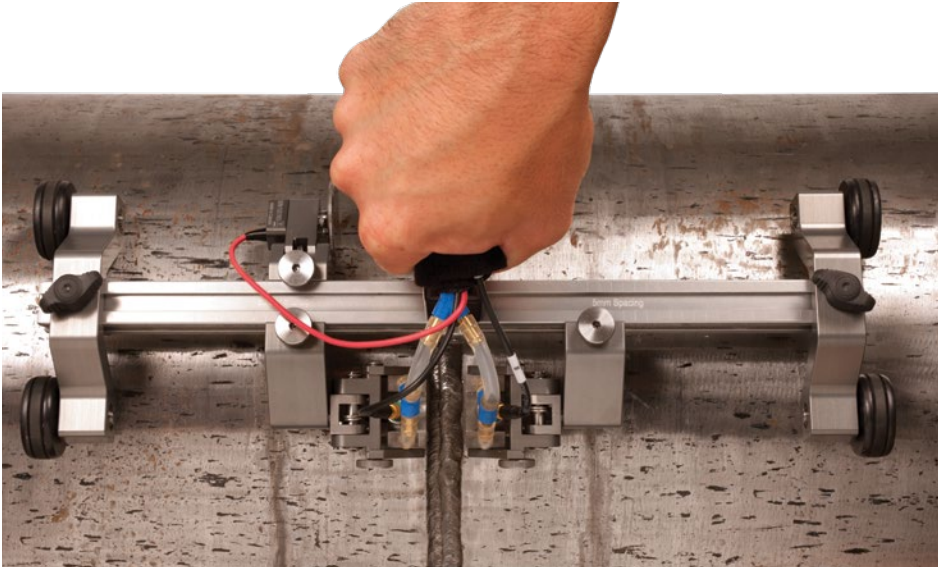

The new HST-Lite scanner is the perfect choice for cost-effective, one-channel TOFD inspections when signal quality is important. The combination of magnetic wheels and spring-loaded probe holders offer the stability required to perform high-quality, one-line inspections. The scanner can be operated using only one hand and will attach to ferromagnetic surfaces even when in an upside-down position.

The scanner's position can be encoded on flat surfaces or around the circumference of pipes as small as 4.5 in. (114.3 mm) OD. Adjustment of the scanner components can be performed without tools.

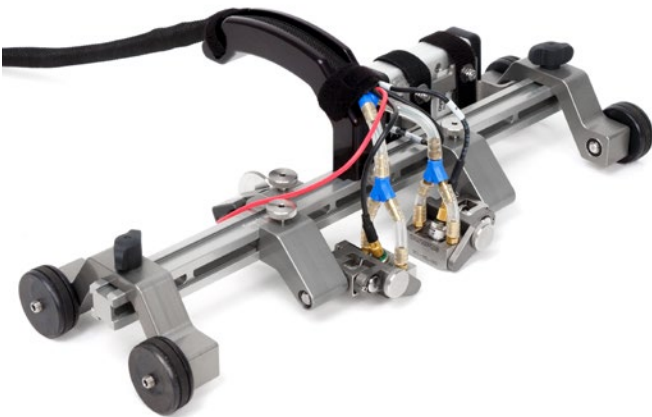

Ordering Information

Part Number	Item Number	Description
HST-Lite	U8750061	Scanner (see standard inclusions).
HST-Lite-kit01	U8750062	Package includes: Scanner 2x 10 MHz, 3 mm TOFD probes 2x 5 MHz, 6 mm TOFD probes 2x ST1-45L-IHS 2x ST1-60L-IHS 2x ST1-70L-IHS 2x 5 m LEMO® 00 to Microdot™ UT cables 2x LEMO 00 to BNC adaptors

Features

- › Circumferential scans performed with two TOFD probes on pipes 4.5 in. (114.3 mm) OD or greater.
- › Four magnetic wheels firmly attach the unit to ferromagnetic inspection surfaces.
- › Light aluminum frame.
- › Independently positioned and spring-loaded probe holders.
- › Waterproof, spring-loaded encoder with 9 step/mm resolution.
- › Removable handle for lower profile.
- › Attachment devices for umbilical cables.
- › The frame design enables probes to be positioned outside the wheels (2 additional magnetic wheels are required).
- › Engraved references on the scanner and pointer on the probe holders ensure easy probe separation measurement.

Standard Inclusions

- › Scanner frame with handle.
- › Four magnetic wheels.
- › Waterproof, spring-loaded wheel encoder with 5 m cable.
- › Two spring-loaded arms (SLA) with TOFD-P/E yokes (31.75 mm wide with 5 mm diameter buttons).
- › Irrigation tubing and accessories.
- › Cable conduit.
- › Carrying case.

Note: Probes and wedges are not included with the scanner.

Specifications

Length in Scan Axis (mm)	Width (mm)	Height (mm)	Weight (kg)
125	385	100*	1,3
*67 mm without handle			

Options

Couplant-Feed Units

See the accessories section on page 34.

5682 Remote Preamplifier Kit

P/N: 5682-KIT02 [U8779091]

Magnetic Wheels

P/N: CHAINSCAN-A-MWHEEL [U8779383]

Replacement Encoder

P/N: HST-Lite-SP-ENC [U8775277]

Extra Handle

P/N: HST-Lite-A-Handle [U8775278]

Extra TOFD Probe Holder Kit

P/N: HST-Lite-A-PH-TOFD [U8775279]

COBRA™ Scanner for Weld Inspection of Small-Diameter Pipes

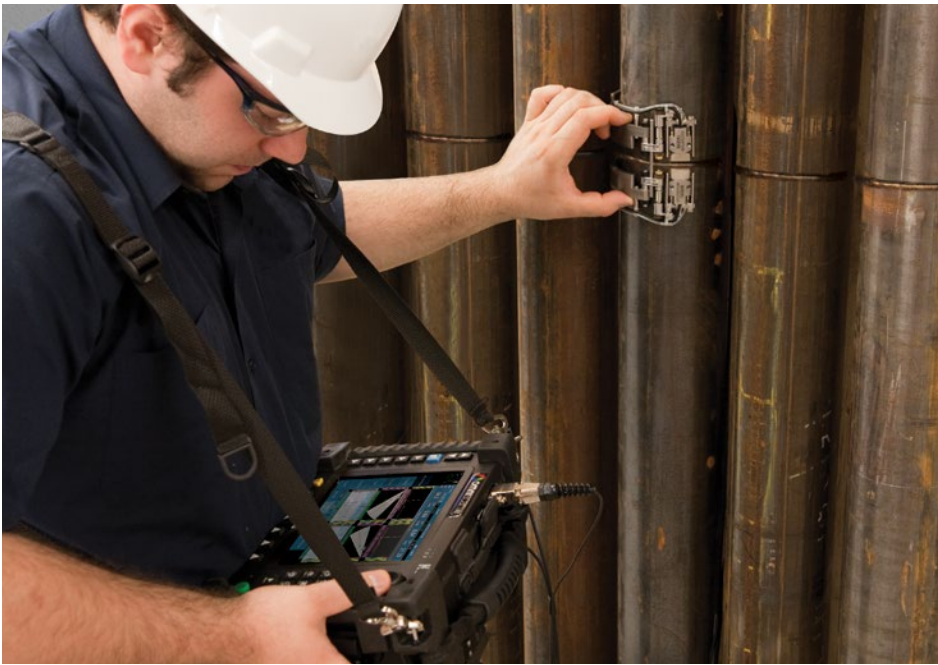

The COBRA™ manual scanner, combined with an OmniScan™ phased array flaw detector, is used to perform circumferential weld inspections on small-diameter pipes. The COBRA scanner holds up to two PA probes for inspections on pipes with outside diameters ranging from 0.84 in. (21 mm) to 4.5 in. (114 mm).

With its very slim design, this manual scanner inspects pipes in limited access areas where minimal clearance is required. Adjacent obstructions, such as piping, supports, and structures, can be as close as 12 mm (0.5 in.). This spring-loaded scanner is designed to clasp carbon steel and stainless steel pipes of various diameters using multiple links. This unique feature enables the scanner to be installed and operated from one side of a row of pipes. The COBRA scanner is characterized by its smooth-rolling encoded movement, which enables accurate data acquisition. The scanner holds up to two phased array probes for complete inspection of the weld in one pass. For pipe-to-component inspections, the scanner can be configured quickly to perform one-sided inspections using a single probe.

This Olympus solution uses low-profile phased array probes with optimized elevation focusing, enhancing detection of small defects in thin-wall pipes.

Specially designed low-profile wedges fitting each pipe diameter covered by the scanner are available for a complete solution.

The COBRA scanner ensures stable, constant, and strong pressure, thus providing good UT signals and precise encoding around the full circumference of the pipe.

Features

- › Covers standard pipes from 0.84 in. to 4.5 in. OD (21 mm to 114 mm).
- › Operates within 12 mm (0.5 in.) clearance (on all standard pipes), permitting inspections in limited access areas.
- › Holds up to two phased array probes for complete weld coverage in one pass.
- › Easy installation and manipulation from one side of a row of pipes.
- › Can be configured to perform one-sided inspections for pipe-to-component evaluations.
- › The included mechanical setup templates eliminate the need for pipe samples when preparing the scanner for standard pipes.
- › The design provides stable and constant pressure around the full circumference of the pipe.
- › Urethane wheels provide smooth radial movement and limited axial drift.
- › Encoder resolution of 32 steps/mm.
- › Compact, lightweight, and portable.
- › Wedges and probes can be changed quickly and easily.
- › The distance between probes can be adjusted from 0 mm to 55 mm.
- › The spring-loaded scanner can be used on ferromagnetic and nonferromagnetic pipes.
- › Waterproof and rust free.



The COBRA scanner on a 0.84 in. pipe with two A15 PA probes with an OmniScan® MX2 16:64 flaw detector displaying two PA groups with sectorial scans and C-scans.

Probes

Part Number	Item Number	Freq. (MHz)	Number of Elements	Pitch (mm)	Elevation (mm)	Elevation Curvature Radius (mm)
2.25CCEV35-A15C-P-2.5-OM*	U8331117	2.5	16	0.5	10	35
3.5CCEV35-A15C-P-2.5-OM*	U8331149	3.5	16	0.5	10	35
5CCEV35-A15-P-2.5-OM	U8331163	5.0	16	0.5	10	35
7.5CCEV35-A15-P-2.5-OM	U8330826	7.5	16	0.5	10	35
10CCEV35-A15-P-2.5-OM	U8331014	10.0	32	0.3	7	35

These probes come standard with an OmniScan® connector and a 2.5 m (8.2 ft) cable.

* A15C casing are based on the same design as the A15 but are 2 mm taller, increasing height clearance.

Wedges

Specially designed SA15 low-profile wedges are available with the different axial outside diameters (AOD) specified in the table below. These wedges have been optimized to position the A15 probe as close as possible to the weld to reduce the number of skips required and as low as possible for maximum height clearance. This is accomplished with no acoustic compromises. These wedges are fitted with irrigation ports and holes for scanner mounting and can be configured to generate 60° shear (N60S) or longitudinal (N60L) waves in steel. Wedges for TOFD inspection are also available (use 3 mm diameter element ST1 probes) with the following refracted angles in steel: 60L, 70L, and 80L.

Note: height clearance required for longitudinal wave inspection is 25 mm with the SA15 and SA25 and 35 mm with the ST1 and right angle cable connector.

Standard Wedge AOD Values and Pipe OD

AOD (in.)	Minimum OD (in.)	Maximum OD (in.)
0.84	0.800	0.840
1.05	0.840	1.050
1.315	1.050	1.315
1.66	1.315	1.660
1.9	1.660	1.900
2.375	1.900	2.375
2.875	2.375	2.875
3.5	2.875	3.500
4.0	3.500	4.000
4.5	4.000	4.500



The solution uses low-profile phased array probes with optimized elevation focusing, which improves the detection of small defects in thin-wall pipes.



Wedges for TOFD inspection are also available.



The A25 dual linear array probe (DLA) series is designed to inspect austenitic material that cannot be otherwise inspected using an A15 probe in pulse echo.

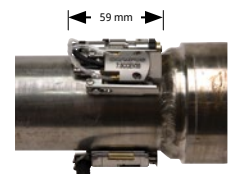

The COBRA™ scanner can also be configured for pipe-to-component weld inspections.

Ordering Information

Part Number	Item number	Description	Package PN: COBRA-K-4.5 (U8750055)
COBRA	U8750053	Small pipe scanner kit with encoder for coverage of 0.84 in. to 4.5 in. OD standard pipes; packaged in hard carrying case	●
7.5CCEV35-A15-P-2.5-OM	U8330826	Low-profile phased array probe (16 elements, 7.5 MHz)	● (x2)
COBRA-A-SA15	U8721205	2 flat SW wedges, plus 10 pairs of curved SW wedges for pipes of 0.84 in. to 4.5 in. OD	●
COBRA-A-SA15LW	U8722168	2 flat LW wedges, plus 10 pairs of curved LW wedges for pipes of 0.84 in. to 4.5 in. OD	
COBRA-A-ST1-70L	U8701348	2 flat wedges, plus 9 pairs of curved TOFD wedges for pipes of 1.05 in. to 4.5 in. OD	
COBRA-SP-BASIC	U8775166	Basic spare parts kit	
COBRA-SP-FULL	U8775188	Basic spare parts kit plus links and the encoder assembly	
COBRA-SP-SA15	U8750056	One of each of the 11 wedges needed for coverage of 0.84 in. to 4.5 in. OD pipes	
OMNI-A2-SPLIT128	U8100133	Y-adaptor (splitter) to support 2 phased array probes on OmniScan MX2 instruments with PA2 128 elements module	
OMNI-A2-SPLIT64	U8100135	Y-adaptor (splitter) to support 2 phased array probes on OmniScan MX2 instruments with PA2 64 elements module	
OMNI-A-ADP05	U8767016	Y-adaptor (splitter) to support 2 phased array probes on OmniScan MX instruments	
E128P0-0000-OM	U8800428	Phased array cable extensions required to interface between the Omni-A-ADP05 and an OmniScan MX2 instrument with PA1 128 elements module	
EIB64-NT-0-P-0-OM	U8779452	Interbox to support 2 phased array probes on OmniScan MX2 instruments with PA1 64 elements module	
WTR-SPRAYER-4L	U8775153	4 L manual water pump with irrigation tubes and fittings	

HSMT-Compact™ Scanner for Girth Weld Inspection



The HSMT-Compact™ manual one-axis encoded scanner is designed for maintenance weld inspection. It is small, light, and versatile and can be used with up to four probes on plates as well as for circumferential scans on pipes as small as 4.5 in. (114.3 mm) OD. The scanner width can be adjusted and the frame can be extended outside the limit of the wheels to provide a configuration that is suitable for hard-to-reach places, such as pipe-to-component welds.

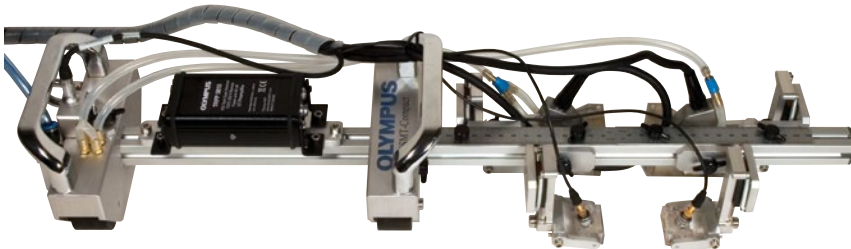

This configuration is suitable for hard-to-reach places, such as pipe-to-component welds.

Options

Divisible Cable Conduit

See the accessories section on page 31.

Couplant-Feed Units

See the accessories section on page 34.

Remote Pulsar/Preamplifier

See the accessories section on page 30.

Extra Probe Holder Kit

Set of two short, spring-loaded arms (SLA) mounted on 90° brackets.

P/N: OPTX0739 [U8779086]

Yokes

See the accessories section on page 35.

Replacement Encoder

P/N: ACIX895 [U8775097]

Spare Parts Kit

P/N: OPTX689 [U8775021]

Features

- › Enables circumferential scan using up to four probes (UT or PA) on 4.5 in. (114.3 mm) OD pipes, or greater.
- › Four plastic-covered magnetic wheels hold the unit against a ferromagnetic inspection surface.
- › Light aluminum frame with customizable width.
- › The frame design enables probes to be positioned outside the wheels.
- › Independently positioned and spring-loaded probe holders.
- › Waterproof, spring-loaded encoder with a 12 steps/mm resolution.
- › Removable handles for lower profile.
- › Attachment devices for umbilical cables.
- › An integrated water manifold that simplifies couplant distribution.
- › Metric/US Customary unit rulers on the scanner for easy probe separation measurement.

Standard Inclusions

- › Scanner frame with handles, and:
 - 250 mm (10 in.) frame bar
 - 450 mm (18 in.) frame bar
 - 650 mm (26 in.) frame bar
- › Four plastic-covered magnetic wheels.
- › Waterproof, spring-loaded wheel encoder with a 5 m cable.
- › Four 90° probe holder brackets.
- › Four spring-loaded arms (SLA).
- › Four TOFD-P/E 31.75 mm yokes.
- › Two PA 40 mm × 38 mm yokes.
- › Two 55 mm yoke arm pairs
- › Irrigation tubing and accessories.
- › Cable conduit attachment fixture.
- › Carrying case.

Note: the umbilical cable, probes, and wedges are not included with the scanner.

Specifications

Length in Scan Axis (mm)	Width (mm)	Height (mm)	Weight (kg)
152	94 + bar length	102	3.2

HSMT-Flex™ Scanner for Girth Weld Inspection



The HSMT-Flex™ scanner is our most capable semiautomated scanner for one-axis encoded inspection of circumferential welds. The scanner comes standard with four of our next-generation probe holders, accommodating a total of eight probes with the addition of four optional probe holders. To provide optimal efficiency and detection capabilities, the mounted probes can be phased array (PA), conventional UT, or a combination of these technologies. Time is saved when switching and adjusting the probes and wedges thanks to the simplified probe holder design with toolless mechanisms and a vertical latching system.

Flexible and Stable by Design

The scanner's articulated design enables it to fit on pipes as small as 4.5 in. OD (114 mm OD), and its spring-loaded arm applies optimal radial pressure for better wedge stability, providing consistent and reliable data acquisition. To further increase the stability on smaller pipes, optional probe holders with integrated pivoting systems are available.

For greater configuration flexibility, one of the HSMT-Flex scanner's side frames is slidable, enabling you to mount probes on the side of the scanner. This is a useful option for targets that are difficult to access, such as pipe-to-component welds.

Options

Umbilical

See the accessories section on page 31.

Remote Pulsar/Preamplifier

See the accessories section on page 30.

Couplant-Feed Units

See the accessories section on page 34.

Laser Guide Kit

Battery-operated laser guiding device for easier weld tracking.

P/N: HSMT-A-Laser-V2 [Q7750221]

Probe Holder Kits

Set of two spring-loaded arms (SLA) mounted on 90° brackets.

Standard: for pipes larger than 12 in. OD.

P/N: PH2-PH-PA-40mm [Q7750228]

P/N: PH2-PH-TOFD-40mm [Q7750229]

Pivoting: for pipes smaller than 12 in. OD.

P/N: HSMT-FLEX2-A-Pivoting [Q7750226]

Spare Parts Kits

P/N: HSMT-FLEX2-SP-Full [Q7750225]

Features

- › Articulated aluminum frame to optimize probe contact on pipes for circumferential weld inspection.
- › Four plastic-covered magnetic wheels, enabling smooth movement on ferromagnetic surfaces.
- › Independently positioned, tool-free spring-loaded probe holders offering several advantages:
 - Adjustable yoke width
 - Vertical latch
 - Configurable spring rate
- › Supports 4 probes with standard inclusions and up to 8 probes with optional probe holder kits.
- › Compact and versatile; the frame bars and sliding side-frame feature offer size and configuration customization.
- › Waterproof, spring-loaded encoder with a 12 step/mm resolution.
- › Removable ergonomic handles.
- › Anchoring system to secure the scanner and attach cable management sleeve.
- › Integrated water manifold simplifies couplant distribution.
- › Metric/US customary unit rulers on the scanner frame for easy probe separation measurement.

Standard Inclusions

- › Scanner frame with handles and:
 - Two 340 mm (13.5 in.) frame bars.
 - Two 500 mm (20 in.) frame bars.
- › Four plastic-covered magnetic wheels.
- › Encoder with 5 m (16 ft) cable.
- › Four spring-loaded arms (SLA).
- › Four TOFD-P/E 31.75 mm (1.25 in.) long yokes.
- › Two PA 40 mm (1.6 in.) wide × 55 mm (2.2 in.) long yokes.
- › Eyelet and cable management sleeve attachments.
- › Irrigation tubing and accessories.

Note: Umbilical, cable management sleeve, probes, and wedges are not included with the scanner.

Specifications

Length in Scan Axis (mm)	Width (mm)	Height (mm)	Weight (kg)
263	460	147	4.5



The articulated design of the HSMT-Flex scanner enables you to inspect pipes as small as 4.5 in. OD (114.3 mm OD) with up to 8 probes.

AxSEAM™ Long Seam Weld Scanner

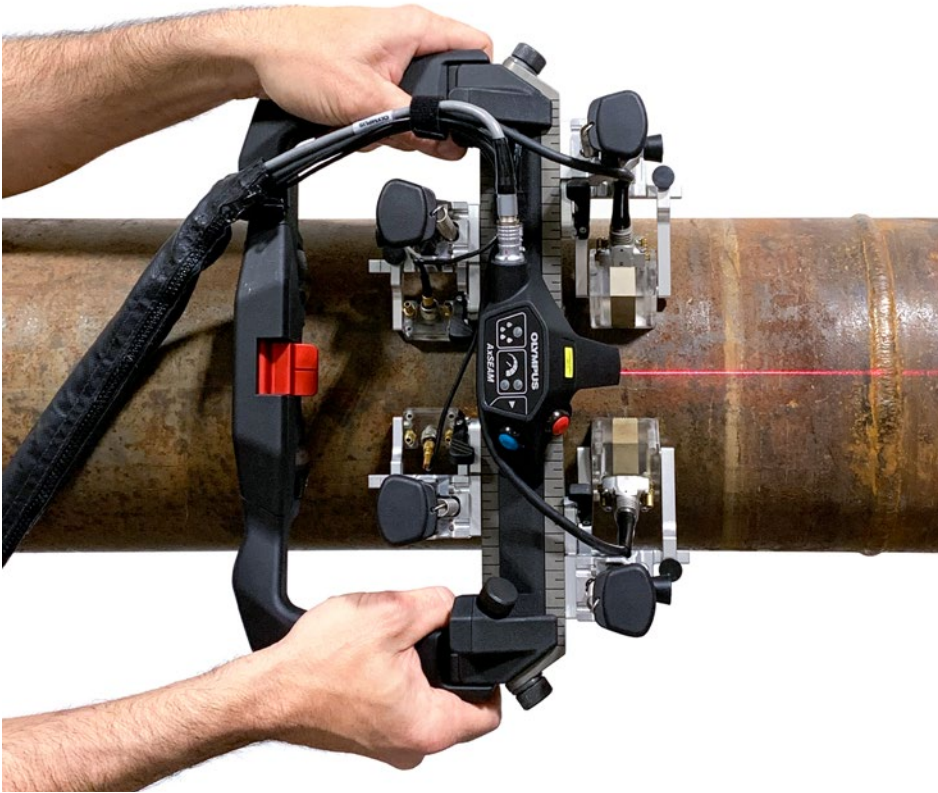

Inspecting the weld seams of pipes in the longitudinal direction can be more challenging than circumferential scanning. With only a few simple adjustments, the AxSEAM™ scanner user can easily switch between longitudinal and circumferential scanning, change the probe separation, or adapt to changes in pipe diameter.

The AxSEAM scanner includes the innovative ScanDeck™ module, enabling one operator to perform the scan without needing to manipulate or monitor the acquisition instrument. Its four probe holders accommodate time-of-flight diffraction (TOFD) and phased array (PA) probes, so the operator can perform a complete seam weld inspection, including TOFD/PA screening and the total focusing method (TFM)* to further investigate regions of interest and difficult-to-detect flaws, such as vertical or hook cracks, without switching probes. The AxSEAM scanner's versatility provides operators with a complete scanning system, so they can accomplish more with less equipment for a faster return on investment (ROI).

Improved Control over Data Integrity for Challenging Welds

The ScanDeck™ module's connection to the OmniScan X3 flaw detector provides several advantages for more challenging weld inspection conditions and for total focusing method requirements:

- › The ScanDeck module's scan speed status LEDs let the operator know when it has exceeded the maximum acquisition rate. This is an important factor for TFM inspection, which typically has a lower scan speed threshold.
- › The coupling check LED, which is connected to the phased array channel on the OmniScan X3 unit, enables the operator to monitor loss in coupling. This information is especially useful when inspecting flush welds, a common feature of ERW, that lack cap or root geometry echoes to rely on.

Features

- › Adapts easily to wide range of pipe diameters:
 - Longitudinal welds: 152.4 mm (6 in.) OD up to flat
 - Circumferential welds: as small as 254 mm (10 in.) OD with 4 probes and 114.3 mm (4.5 in.) OD with 2 probes
- › ScanDeck™ module communicates directly with an OmniScan™ instrument:
 - One button is used to start the acquisition on any OmniScan™ instrument and the other button activates the laser guide
 - LED status indicators alert to loss of coupling and when the scan speed has exceeded the maximum to prevent missed data*
- › Innovative probe holders with toolless adjustments and vertical latching system.
- › 4 probe holders accommodate both PA and TOFD probes.
- › Patented dome-shaped magnetic wheels adapt to pipes without adjustment between changes in diameter.
- › Brake system.
- › Urethane coating on the wheels to make scanning smoother.
- › Convenient cable management sleeve.

*TFM and LED support are provided by the OmniScan™ X3 flaw detector.



New innovative ScanDeck™ module



Flexible Configuration

With a few simple adjustments, the AxSEAM scanner can be used to perform circumferential scanning of girth welds as well as axial scanning of long seam welds on a wide range of pipe diameters.

Longitudinal



The AxSEAM scanner can scan longitudinal welds on pipes from 152.4 mm (6 in.) OD up to flat

Circumferential



With 2 probes, the AxSEAM scanner can inspect circumferential welds on pipes as small as 114 mm (4.5 in.) OD



With 4 probes, it can scan circumferentially on pipes starting at 254 mm (10 in.) OD

RollerFORM™ Phased Array Wheel Probe



Features

- › Offered in two different sizes with a 51.2 mm or 128 mm beam width.
- › Exceptional coupling, requiring minimal couplant.
- › Acoustic impedance similar to water.
- › 25 mm water delay line enables inspection of composites up to 50 mm thick.
- › Can be used in accordance with existing aircraft manufacturer procedures.

Standard Inclusions

- › Phased array probe with OmniScan connector.
- › Waterproof encoder.
- › Laser guide.
- › Indexer and Start Acquisition buttons.
- › Filling/spraying pump and tubing.

The RollerFORM™ phased array wheel probe is designed to address the inspection of composites and other smooth-surfaced materials commonly used by the aerospace industry. An affordable and easy-to-implement replacement for full 2D encoding systems, the RollerFORM probe also offers a viable alternative to immersion techniques.

The probe's unique tire material has been specifically developed to provide high-quality, immersion-like ultrasonic testing. Minimal couplant and pressure are required to provide excellent coupling and a strong signal, even in difficult scanning positions.

Just Roll It for Instant Results

The RollerFORM probe, combined with an OmniScan phased array instrument, uses zero-degree ultrasonic beams for manufacturing and maintenance inspections. Common applications include delamination sizing, porosity quantification, and bonding integrity in composite materials as well as wall-loss monitoring in aluminum panels. With its wider tire and probe, the RollerFORM XL scanner offers greater beam coverage for increased productivity and improved probability of detection (POD). For more attenuative materials, the 1 MHz version of the RollerFORM XL scanner has a larger elevation to provide the higher penetration required for applications such as spare cap and shear web bonding inspections in wind turbine blades.

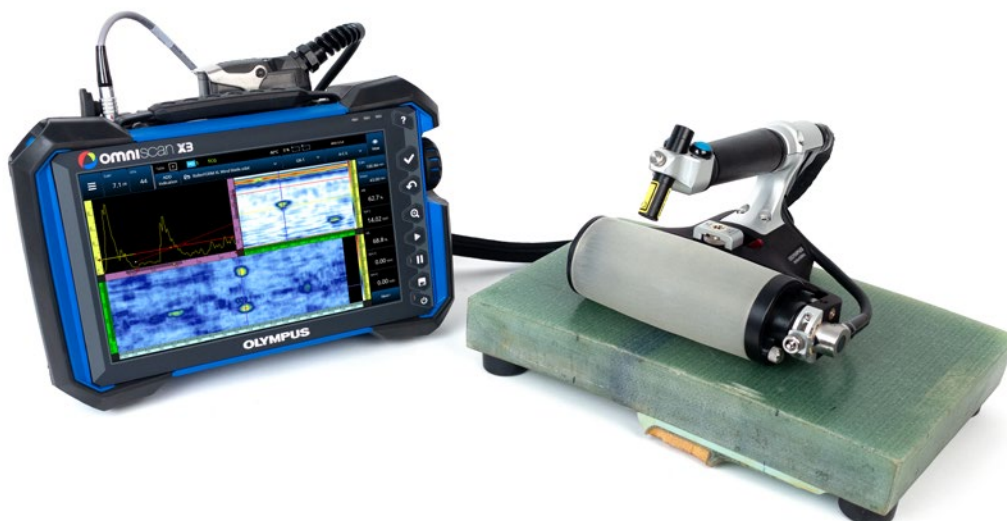

With its integrated indexing button, the ergonomically designed RollerFORM probe enables you to map the surface of an inspected material by acquiring multiple one-line C-scans and combining them in real time into a single image. The built-in laser guide facilitates straight and precise one-line scans.

In addition to providing exceptional coupling, the probe's tire is made of a unique material that closely matches the acoustic impedance of water allowing efficient transmission of ultrasound energy to the part. Since the tire is transparent, you can easily identify the presence of air bubbles or contaminants within the water chamber.

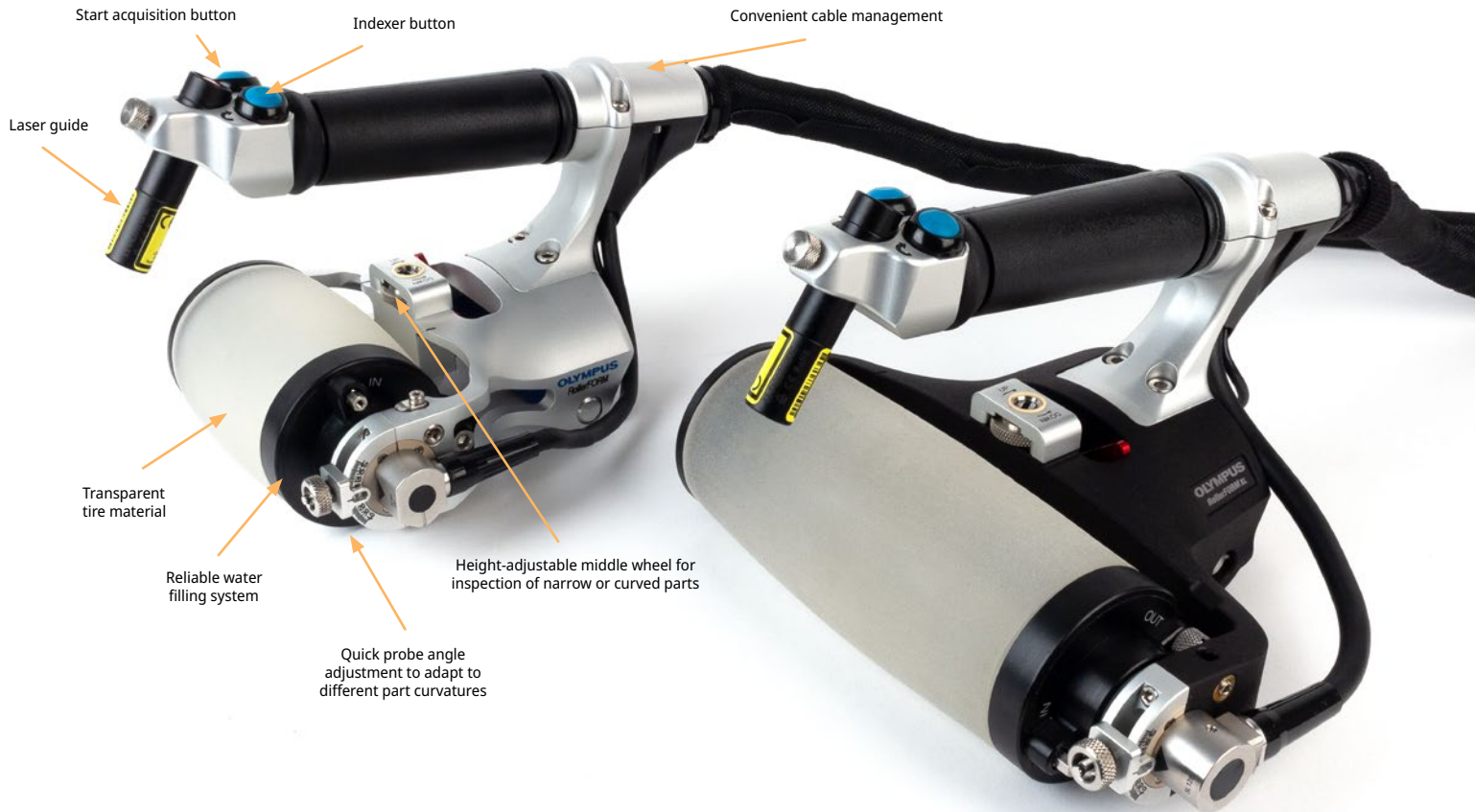

Ordering Information

Part Number	Frequency (MHz)	Delay Line Height (mm)	Number of Elements	Pitch (mm)	Active Aperture (mm)	Elevation (mm)	Probe Casing Model
RollerFORM-3.5L64	3.5	25	64	0.8	51.2	6.4	IWP1
RollerFORM-5L64	5	25	64	0.8	51.2	6.4	IWP1
RollerFORMxl-1L128	1	25	128	1	128	13	IWP2
RollerFORMxl-3.5L128	3.5	25	128	1	128	6.4	IWP2
RollerFORMxl-5L128	5	25	128	1	128	6.4	IWP2

Available with 2.5m or 5m long cables

HydroFORM™ Scanner for Corrosion Mapping

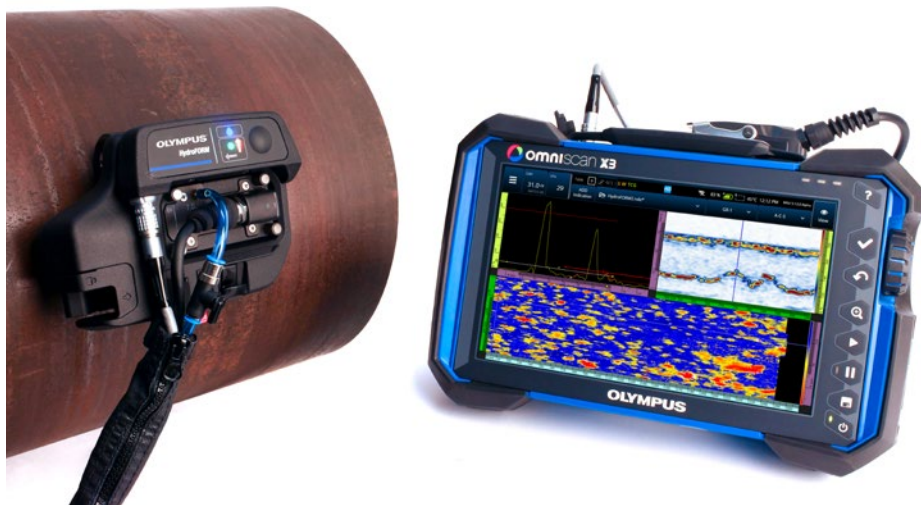

Easy to deploy and optimized for one-person operation, the HydroFORM™ scanner is a complete 2D encoding corrosion mapping solution. Equipped with our ScanDeck™ module offering acquisition instrument feedback and control functions and an integrated index axis encoder, it enables fast and reliable phased array (PA) two-axis scanning.

Acquire high-resolution data of pipes and large surfaces in minimal time for efficient and reliable wall-thickness mapping and midwall damage detection. The unique water-column system enables inspection of curvatures 4 in. OD (101 mm) and up.

Specifications

Phased array probe	I8
Maximum one-line scan coverage (width)	60 mm
Delay line medium	Water
Delay line height	14 mm or 38 mm
Position of repeat interface echo (in steel)	50 mm (14 mm delay line) 150 mm (38 mm delay line)
Typical near-surface resolution ($\frac{1}{8}$ in. FBH)	1.5 mm
Depth resolution	0.1 mm
OD inspection range	4 in. and greater
ID inspection range	10 in. and greater (16 in. with index encoder)
Dimensions	16 cm × 14 cm × 8.5 cm with index encoder
Scanner compatibility	Semiautomated: ChainSCANNER™ and MapSCANNER™ Automated: SteerROVER™ (remote) and MapROVER™

Features

To optimize the productivity of raster scanning, the HydroFORM system is equipped with several efficiency-boosting features:

- › Integrated X and Y axis encoders
- › Multifunction remote action button
- › Index position and coupling indicators
- › Speed check warning
- › Efficient bubble management
- › Easy-to-index magnetic wheels
- › Braking system

Standard Inclusions

The HydroFORM manual corrosion mapping scanner kit includes:

P/N: HydroFORM2-K-Manual-YEnc [Q7500189]

- › One probe holder with a water delay line
- › One carriage with four magnetic wheels
- › One phased array probe (7.5L64-I8)
- › Replacement foam gaskets and gasket protectors
- › 14 mm and 38 mm delay line plates
- › One 7.5 m encoder cable
- › Umbilical, including encoder cable and irrigation tube in a zipper type protective sleeve

Kits are available in configurations adapted to the four compatible scanners (see “Ordering Information” on page 17).



With integrated index axis and scan axis encoders, the HydroFORM scanner is an easy-to-deploy 2D encoded corrosion mapping solution.

Versatile 2D Encoding Solution

High-performance corrosion mapping for rough and uneven surfaces

Achieve immersion-tank-quality phased array inspection without concerns about water coupling. The HydroFORM scanner's unique low-flow water-column design with foam gaskets conforms to flat and curved surfaces, eliminating the need for a wedge.

For better wear and temperature resistance, innovative gasket protectors can be used to prolong the life of the foam gaskets. These protectors reduce damage caused by scanning over rough profiles and welds and surfaces as hot as 90 °C (194 °F).

Smooth-indexing magnetic wheels and improved bubble management expand the HydroFORM scanner's capabilities to vertical and inverted scanning applications, such as corrosion monitoring of tank walls.

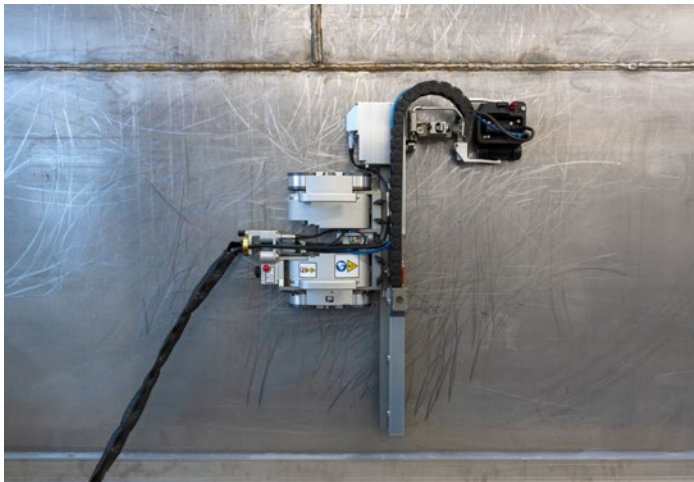

ScanDeck™ Module

Integrated Controls and Status Indicators

Our ScanDeck module provides important feedback directly in your eyeline while scanning. When using an OmniScan™ X3 series flaw detector with the scanner, you fully benefit from all the functionalities of the ScanDeck module.

Control button:

- › Start the data acquisition on the OmniScan unit
- › Switch between guided and freehand scanning modes
- › Toggle between index and scan axis scanning

Indicator LEDs:

- › Index position guidance (guided mode)
- › Insufficient coupling warning
- › Alert when maximum scan speed exceeded
- › Active encoder (X, Y, or both)



Ordering Information

Part Number	Item Number	Description
Hydroform2-k-manual	Q7500188	HydroFORM manual corrosion mapping system with ScanDeck (7.5m)
Hydroform2-k-manual-Yenc	Q7500189	HydroFORM manual corrosion mapping system with ScanDeck and index encoder (7.5m)
Hydroform2-k-manual-15m	Q7500190	HydroFORM manual corrosion mapping system with ScanDeck (15m)
Hydroform2-k-manual-Yenc-15m	Q7500191	HydroFORM manual corrosion mapping system with ScanDeck and index encoder (15m)
Hydroform2-k-adpchain	Q7500195	HydroFORM semi-automated corrosion mapping system compatible with ChainSCANNER (7.5m)
Hydroform2-k-saut	Q7500192	HydroFORM semi-automated corrosion mapping system compatible with MapSCANNER (7.5m)
Hydroform2-k-aut	Q7500193	HydroFORM automated corrosion mapping system compatible with MapROVER and SteerROVER (7.5m)
Hydroform2-k-aut-30m	Q7500194	HydroFORM automated corrosion mapping system compatible with MapROVER and SteerROVER (30m)
HYDROFORM-SP-FOAM	U8775184	100 foam gasket spare part kit

FlexoFORM™ Scanner for Pipe Elbow Inspection



The FlexoFORM™ scanner solves the challenges of pipe elbow inspection and enables 100% coverage with intuitive C-scan imaging. Incorporating Olympus' flexible array probe technology, the FlexoFORM scanner solution can map corrosion in pipe elbows from 4.5 in. OD and up. The FlexoFORM scanner features a water column with a foam gasket that contours to the pipe's inner concave (intrados) and outer convex (extrados) curves, for optimum coupling and a reliable signal. The flexible array is shaped by the wedge to sit concentric to the elbow's surface, enabling the use of simple 0-degree focal laws, similar to inspecting a flat surface. The water wedge can be changed in seconds and is the only part that differs from one diameter to the other. The scanner and flexible probes are designed to cover the entire range of diameters, making the FlexoFORM scanner a versatile and cost-effective solution.

Wedge series have also been designed for small-diameter pipes and automated scanning.



Features

- › Quickly measure the wall thickness of elbows
- › 100% elbow coverage for a high probability of detection
- › High-resolution data (1 mm × 1 mm)
- › Intuitive 2D C-scan imaging
- › Built-in encoder for scan direction
- › Smart indexer button positioned on the scanner
- › Same probe and scanner are used to cover the entire range of diameters
- › Magnetic wheels minimize the operator's physical input
- › Water wedges for a wide range of pipe diameters
- › Constant water column

Alternative Configurations



SFA1-FLEXO longitudinal scanning of pipes

The FlexoFORM scanner can also inspect pipes in the longitudinal direction. This configuration is especially useful for smaller pipes or when the region of interest is concentrated within a specific sector around the pipe. The FlexoFORM scanner can also be a powerful tool for the inspection of water walls in power generation boilers.



SFA1-SMALL wedge series for small-diameter pipes

These wedges are used to inspect pipes with diameters smaller than 4.5 in. Users can manually scan the extrados of elbows or pipes from 1.3 in. OD up to 4 in. OD. The wedge can be fitted with a Mini-Wheel™ encoder to create an encoded one-line scan.



SFA1-AUTO wedge series for automated 2D raster scanning

For 100% inspection of corrosion in pipes, the HydroFORM™ scanner, when combined with the MapROVER™ scanner, represents a field-proven, reliable option. However, in some applications, scanning in the longitudinal direction may be preferred over scanning circumferentially. The SFA1-AUTO wedge series works on pipes with diameters from 8.6 in. OD and up, including flat surfaces.



Ordering information and glossary

Item Number	Part number	Description
Q7500062	FlexoFORM	FlexoFORM package with probe and one (1) SFA1 water wedge for 8.625 in. outside diameter. 5 m long cables compatible with current generation OmniScan and FOCUS instruments.
Q7500063	FlexoFORM-Kit	FlexoFORM package with probe and six (6) SFA1 water wedges (for 4.5 in., 6.625 in., 8.625 in., 10.75 in., 12.75 in., and 16 in. outside diameters). 5 m long cables compatible with current generation OmniScan and FOCUS instruments.
Q3301202	7.5L64-64X7-FA1-P-5-OM	Flexible phased array probe, 7.5 MHz, 64 elements, 1 mm pitch, 7 mm elevation, FA1 case type for the FlexoFORM scanner, SFA1-SMALL and SFA1-AUTO wedge series, 5 m cable length, and OmniScan connector.

Probe Type	Wedge Series	Pipe Diameter
SFA1	FLEXO	OD8.625

FLEXO Compatible with FlexoFORM. Diameter range: 4.5in OD up to flat.
AUTO Compatible with MapROVER and SteerROVER. Diameter range from 8.625in OD up to Flat.
SMALL Manual inspection with Mini-Wheel encoder. Diameter range from 1.3in up to 4in OD.

Measured external pipe diameter (inches)

Motorized One-Axis Scanner

WeldROVER™ Scanner for Weld Inspection



The WeldROVER™ scanner is made for customers who require a more stable inspection than that provided by manual scanners and who want a more economical package than that of the high-production zone-discrimination systems typically used in offshore pipeline construction.

The WeldROVER simple, industrial-strength, one-axis encoded scanner provides you with fully mechanized automated data acquisition. It is designed to perform fast and efficient phased array inspections on ferromagnetic piping or vessel girth welds and long seams with minimum training and setup time. The scanner can be configured with up to six probes for phased array, TOFD, and conventional UT inspection.

The WeldROVER scanner is easy to use. It is operated by a simple two-button remote control with variable speeds. The scanner directly interfaces with OmniScan™ or FOCUS instruments without the need for complex software, motion controller electronics, or configuration. The laser guide indicator helps the operator manually adjust the scanner direction using the steering lever. This allows precision data to be acquired without the need for guide bands, complex tracking systems, or motorized steering capability. It is a perfect fit for companies offering fully mechanized, automated phased array (AUT) inspection services and requires less than one hour of training for those individuals who have completed the basic OmniScan course.

1 Interface with TomoScan FOCUS LT™ can be achieved using the optional encoder cable adaptor.

Features

- › Can support up to six probes for TOFD, phased array, or pulse-echo inspections.
- › Constant scanning speed control for smooth data acquisition at any speed.
- › Compact motion controller offering 10 different scan speeds from 5 mm/s to 50 mm/s.
- › Simple two-button remote control for jog or constant encoded motion in either the backward or forward direction.
- › Performs data acquisition using OmniScan or FOCUS¹ instruments with less than five minutes configuration time.
- › The four industrial-strength magnetic wheels for use on ferromagnetic surfaces.
- › Integrated water manifold for simple and efficient couplant delivery.
- › Emergency-stop button located on the scanner.
- › A laser guide indicator to help the operator follow the weld centerline or any other inspection reference.
- › Room to integrate a remote pulser/preamplifier for improved TOFD-P/E inspections.
- › Divisible cable conduit umbilical offers cable protection and configuration flexibility. Minimal time needed for probe reconfiguration.
- › Waterproof (IP65).

Configurations

A typical configuration for compliance with ASME codes is two PA probes and one or two pairs of TOFD probes.

Circumferential scan

- › Supports two probes at the back and two probes at the front of the scanner on pipes from 4 in. OD and greater.
- › Supports up to four probes at the front of the scanner on pipes from 12 in. OD and greater.
- › Supports up to six probes at the front of the scanner on pipes from 16 in. OD and greater.

Longitudinal scan

- › Supports up to six probes at the front of the scanner on pipes from 30 in. OD and greater.

Note that on smaller pipes, the probe separation distance will be limited.



Supports two probes at the back and two probes at the front of the scanner on pipes from 4 in. OD and greater.

Standard Inclusions

- › One motorized scanner with rotating probe-holder arms at the front and back of the scanner.
- › Two probe holder frame bars of 200 mm (8 in.) and one of 430 mm (17 in.).
- › Remote control with a 5 m cable.
- › MCDC-01: one-axis DC motion controller.
- › Power supply.
- › Encoder cables linking the MCDC-01 to the OmniScan™.
- › Six spring-loaded arms (SLA), pivoting probe holders, and all the brackets needed for the different configurations.
- › Four TOFD-P/E 31.75 mm yokes.
- › Two PA 40 mm × 55 mm yokes.
- › Two PA 40 mm × 65 mm yokes for PWZ1 and A14 probes.
- › Two PA 40 mm × 46 mm yokes.
- › Laser guide and holder.
- › Two steering levers.
- › One 5 m divisible conduit for cable protection and attachment to the scanner.
- › Irrigation tubing and fittings.
- › Scanner and accessory carrying case.

Data acquisition can be handled completely by an OmniScan flaw detector (not included in WeldROVER package)

Note: All cables for scanner operation are 5 m. Probes and wedges are not included with the scanner. The WeldROVER can also be optionally delivered with 10 m cables.

Options

Couplant-Feed Units

See the accessories section on page 34.

Remote Pulsar/Preamplifier

See the accessories section on page 30.

Extra Spring-Loaded Probe Holder

P/N: WELDROVER-A-SLA [U8775125]

Extra Laser Guide

P/N: WELDROVER-A-LASER [U8775124]

Instrument case

Modular instrument and accessory hard carrying case. The modules can be used to transform the scanner case into a workstation.

P/N: WELDROVER-A-ICASE [U8775123]

Yokes

See the accessories section on page 35.

Spare Parts Kit

Basic spare part kit for the WeldROVER scanner.

P/N: WeldROVER-A-SPKit [U8775122]

P/N: WeldROVER-A-SPKit-10M [U8775149]

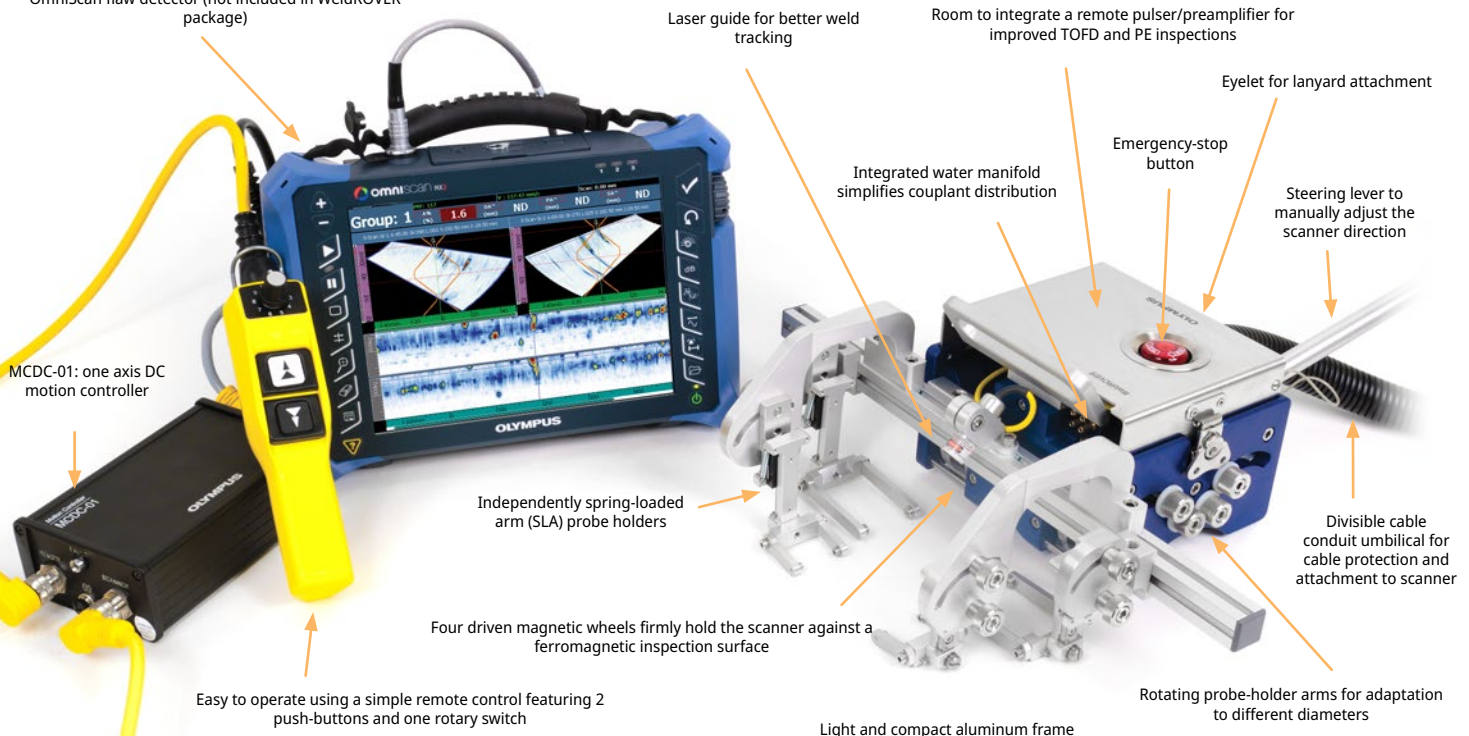

Specifications

Scanner speed: 5 mm to 50 mm per second

Encoder resolution: 2100 steps/mm (typical)

Power consumption: 90 W

Maximum input current: 4 A

Voltage: 24 VDC

Power supply input voltage:
100 VAC to 240 VAC; autoswitching

Component	Length (mm)	Width (mm)	Height (mm)	Weight (kg)
Scanner with long bar and six probes	430	380	175	12.0
Scanner with small bars and four probes	380	200	175	11.0
MCDC-01 motion controller	175	110	60	1.5
Power supply	200	85	50	1.0
Remote control	230	50	90	0.8

Motorized Two-Axis Scanner

MapROVER™ Scanner for Corrosion Mapping



Thanks to its two motorized axes, the MapROVER scanner offers improved productivity. Easily control the scanner with the touch screen remote control, which eliminates the need for a computer or complex motor-controller programming. When combined with the HydroFORM™ phased array corrosion mapping solution, the MapROVER is a very powerful tool for C-scan imaging of remaining wall thickness and mid-wall anomalies. When used with the OmniScan™ SX UT flaw detector for conventional dual UT inspection, the MapROVER scanner is a cost-effective and simple option over the more complex systems.

Ordering information

Part number	Item Number	Description
MapROVER	Q7500003	MapROVER scanner kit with 7.5 m long cable
MapROVER-30m	Q7800017	MapROVER scanner kit with 30 m long cable
HydroFORM-K-AUT	Q7750068	7.5 m HydroFORM with PA probe, buggy and encoder
HydroFORM-K-AUT-30m	Q7800018	30 m HydroFORM kit with PA probe, buggy and encoder
D790-SM	U8450009	Dual UT probe D790-SM
ABWX612	U8700372	Economical fixture for D790 dual UT probe
MapROVER-A-D790-ProbeHolder	Q7750070	Rugged fixture for D790 dual UT probe
C174-LM-UDOT-7.5M	Q7670010	7.5 m UT cable (Lemo-00 to Udot)
C174-LM-UDOT-30M	Q7670011	30 m UT cable (Lemo-00 to Udot)
MapROVER-A-weldkit-2probes-V2	Q7750114	Weld probe holder kit for 2 probes with PA and TOFD arms
MapROVER-A-weldkit-4probes	Q7750083	Weld probe holder kit for 4 probes with 2 PA + 2 TOFD probe holders

Features

- › Four magnetic wheels that are motorized for constant data acquisition up to 147 mm/s.
- › Motorized raster arm enabling 600 mm scan width travelling at a speed up to 900 mm/s.
- › Touch screen remote control with two joysticks, enabling users to perform jog or constant encoded motion as well as two different choices of complete automatic raster scan patterns.
- › Performs data acquisition using OmniScan or FOCUS instruments with less than five minutes configuration time.
- › Cable management system for increased reliability.
- › Emergency-stop button located on the scanner and on the power supply.
- › Divisible cable conduit umbilical offers cable protection and configuration flexibility.
- › Handle for scanner manipulation and umbilical attachment.

Standard Inclusions

- › Nonsteerable motorized scanner.
- › Motorized raster arm 600 mm long.
- › Spring loaded probe holder compatible with the HydroFORM™ scanner and Dual Linear Array™ (DLA) probe.
- › Touch screen remote control.
- › One skew arm to assist scanner direction.
- › Power controller.
 - Detachable umbilical cables with divisible protection sleeve.
 - Encoder cable linking to OmniScan instruments.
 - Carrying case.

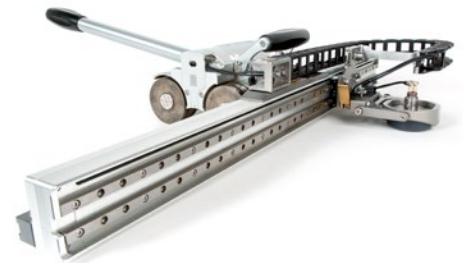

The MapROVER scanner is also capable of inspection using dual element conventional UT probes. When combined with the OmniScan SX UT instrument, this alternative solution is quite affordable.

Configurations

The standard MapROVER scanner application is for corrosion mapping. For greater versatility, it can also be fitted with an optional probe holder kit for weld inspection.

Corrosion mapping

- › A motorized raster arm comes standard for a 600 mm wide travel distance.
- › Standard probe holder compatible with the HydroFORM™ scanner or D790 dual conventional UT probe when using the optional probe fixture and cables.

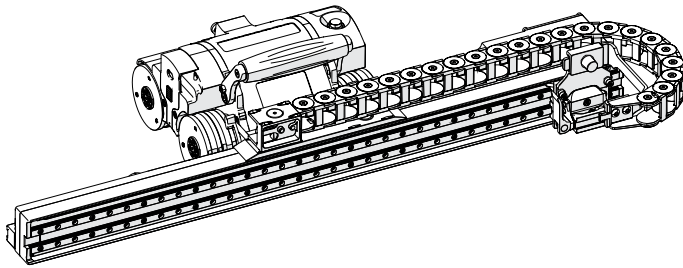

Weld inspection

- › An optional probe holder rack can be mounted on the scanner for a one-line scan.
- Only the kit for 2 probes can be mounted on the raster arm.

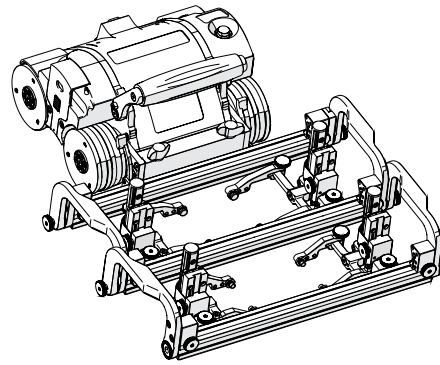

High-Temperature Scanning

- › Avoid costly downtime and perform fast, efficient corrosion mapping on pipes, vessels, and flat surfaces as hot as 350 °C (662 °F) with the MapROVER HT scanner.
- › Cooling system electronically controls liquid-filled cooling plates on the raster arm and crawler.

OmniScan™ acquisition unit

Power controller

HydroFORM scanner and holder assembly

Touch screen remote control

Motorized scanner with 4 magnetic wheels

Motorized raster arm

Specifications

Maximum scanner speed	142 mm/s
Maximum raster arm speed	900 mm/s
Scanner resolution	1354 steps/mm
Raster arm resolution	240.2 steps/mm

SteerROVER™ Scanner for Weld Inspection and Corrosion Mapping



The SteerROVER™ motorized scanner is a rugged and easy-to-operate steerable magnetic scanning solution. Steer the scanner at a distance using the robust handheld remote controller with its easy-to-read touch screen. Use it to simplify inspections of large ferromagnetic surfaces, such as pressure vessels and tanks, and achieve reliable phased array (PA) ultrasonic testing of areas that are difficult to reach.

The versatile SteerROVER system can be configured with a motorized raster arm to perform corrosion monitoring or a probe holder rack to inspect longitudinal and circumferential welds. Increase your ability to keep the scanner properly aligned with the optional RECON camera kit. The cameras ease navigating at a distance and help you ensure that the probes are optimally positioned.

Configurations

The SteerROVER scanner can be ordered in different configurations depending on the application (weld or corrosion) and by combining different raster arm and cable length options.



The SteerROVER scanner and probe holder rack can bend to perform inspection of longitudinal welds.

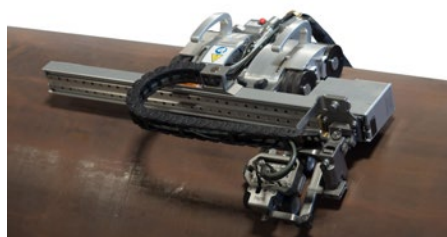

The SteerROVER scanner, when fitted with a motorized raster arm, is a powerful solution for corrosion inspection in remote locations.

Features

- › Steerable scanner comprised of two pods with independent motors and four strong magnetic wheels.
- › Touch screen remote with two joysticks; configure so that scanner movement requires constant user input (jog) or so that one input starts the scanner and a second stops it.
- › Two complete automatic raster scan patterns are available.
- › Can be ordered with two choices of motorized raster arms for corrosion inspection or a probe holder rack for weld inspection with four probes (increase to six probes with optional probe holders).
- › Emergency-stop buttons located on the scanner and on the power controller.
- › Divisible cable conduit umbilical offers cable protection and flexible configurations.

Standard Inclusions

- › Steerable motorized scanner.
- › Touch screen remote control.
- › Power controller.
- › Detachable umbilical cables with divisible protection sleeve.
- › Encoder cable linking to current generation OmniScan and FOCUS instruments.
- › Irrigation tubing.
- › Carrying case(s).
- › Motorized raster arm or probe holder rack (depending on configuration).

Motorized raster arm

- › Spring-loaded probe holder compatible with the HydroFORM™ scanner and Dual Linear Array™ corrosion probe.

Pivoting probe holder rack

- › Four spring-loaded probe holders.
- › Two adjustable yokes to hold phased array probes (up to 57.6 mm wide and 48.5 mm long).
- › Two adjustable yokes to hold TOFD-P/E probes (up to 45 mm wide and 36.8 mm long).

Note for pipe inspection: To limit scanner drift, it is recommended to scan with the raster arm and index with the scanner wheels. For pipe inspection with the SteerROVER scanner, the SFA1-AUTO wedge series should be used rather than the HydroFORM scanner. If the HydroFORM scanner is to be used, the MapROVER scanner should be considered over the SteerROVER scanner.

Specifications

Circumferential pipe diameter range	2.75 in. (70 mm) up to flat
Longitudinal pipe diameter range	12 in. (305 mm) up to flat
Internal, circumferential pipe range	24 in. (610 mm) and up



Ordering Information

Part number	Item Number	Description
MapROVER-A-Laser	Q7750081	Optional laser guide to be used with the probe holder rack.
MapROVER-SP-VPH-PA	Q7750121	Vertical probe holder for phased array probe.
MapROVER-SP-VPH-TOFD	Q7750126	Vertical probe holder for TOFD probe.
MapROVER-A-D790-ProbeHolder	Q7750070	Rugged probe holder and mounting fixture for D790-SM dual UT probe.

RECON Camera System

The two-camera RECON kit can be added to the SteerROVER scanner to assist in navigating at a distance, keeping the weld centered, and helping ensure that the probes remain in constant contact with the surface. Live video and still images can be viewed and recorded using the RECON Studio app on the included tablet.



Manual Two-Axis Scanner

ChainSCANNER™ Solution for Pipe Inspection



The versatile ChainSCANNER two-encoded axes manual pipe-inspection solution works on pipes with outside diameters from 1.75 in. to 38 in. (45 mm to 965 mm). The scanner, which is held by chain links instead of magnetic wheels, is capable of inspecting ferromagnetic or nonferromagnetic surfaces. The chain links help ensure a straight displacement of the scanner by eliminating steering problems. It is also very useful when the area around the pipe is not entirely accessible, as the scanner can be rotated by pulling on the chain links.

Main applications

- › Circumferential pipe weld inspections with phased array, TOFD, or conventional UT (pictured above).
- › Corrosion mapping in conjunction with the HydroFORM™ phased array solution (pictured below).



Features

- › Standard configuration using one or two probes, and optional configuration using four probes for TOFD, phased array, or pulse-echo inspections.
- › A pipe range with outside diameters from 1.75 in. to 38 in. (45 mm to 965 mm).
- › An encoded manual scan with up to two axes.
- › Ergonomic handle to protect encoder connectors and provide cable management.
- › Independent chain links are mounted on bearing wheels coated with urethane for smooth rolling.
- › An easy clamping device for quick scanner positioning.
- › Spring-loaded probe holders that ensure good probe contact in any scanner position or orientation.
- › The majority of adjustments can be made without the use of tools.

Standard Inclusions

- › Main module with a scan-axis encoder.
- › Encoded probe-positioning system with lead screw adjustment.
- › Chain links for up to 38 in. pipe ODs, with a quick-release adjustable buckle.
- › One 5 m (16 ft) encoder cable.
- › One 450 mm (17.7 in.) probe-holder bar.
- › Two spring-loaded probe holders with two adjustable PA yokes.
- › Two adjustable TOFD-P/E yokes.
- › One 5 m divisible cable conduit (19 mm ID).
- › Cable conduit attachment fixture.
- › Irrigation tubes and fittings.
- › A ChainSCANNER custom tool.
- › A carrying case.

Note: probes and wedges are not included with the scanner.

Main Module Specifications

Length in Scan Axis (mm)	Width (mm)	Height (mm)	Weight (kg)
114	75	84	1

Encoder resolution:
Circumferential (X) axis: 19.2 steps/mm.
Longitudinal (Y) axis: 226.8 steps/mm.

Options

Remote Pulser/Preamplifier

See the accessories section on page 30.

Couplant-Feed Units

See the accessories section on page 34.

Arm Stabilizer

ChainSCANNER™ arm stabilizer kit. Includes a magnetic wheel block and the holder.

P/N: ChainScan-A-Stabilizer [U8775210]

Chain Links

Extra ChainSCANNER short link. Required on pipe ODs less than 9.6 in.

P/N: ChainScan-A-SLink [U8775127]

Extra ChainSCANNER long link. To be used on pipe ODs greater than 9.6 in.

P/N: ChainScan-A-LgLink [U8750042]



Encoded probe-positioning system with lead screw adjustment.

Additional Packages

Two Additional Probe Packages

Needed to perform inspections with four probes and a preamplifier on the ChainSCANNER.

P/N: ChainScan-A-4Probe [U8775128]

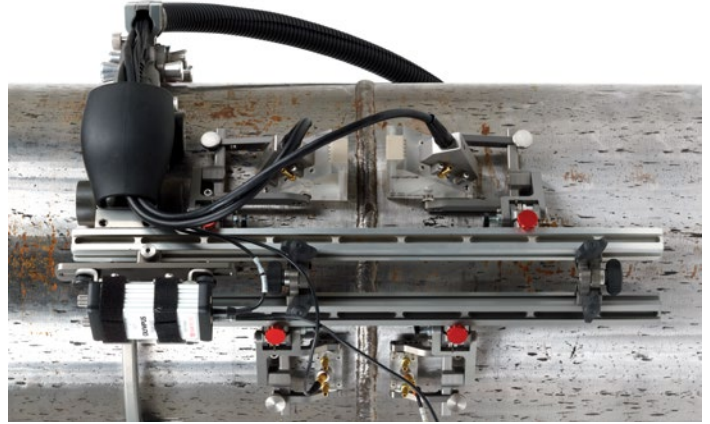

Mouse Package

Needed to use the ChainSCANNER solution as a mouse scanner with magnetic wheels holding the system instead of chain links.

P/N: ChainScan-A-Mouse [U8750037]

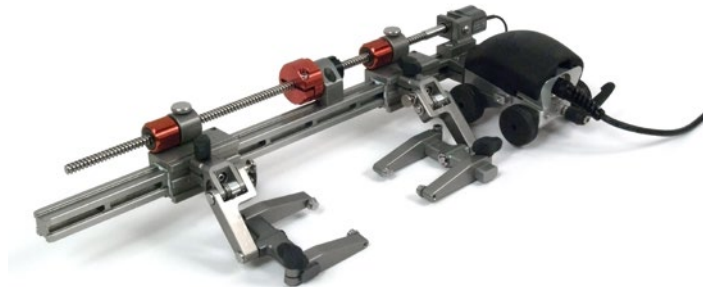

Short Bar Package

A 20 cm probe-holder bar and lead screw kit for restricted space applications.

P/N: ChainScan-A-SBar [U8775129]

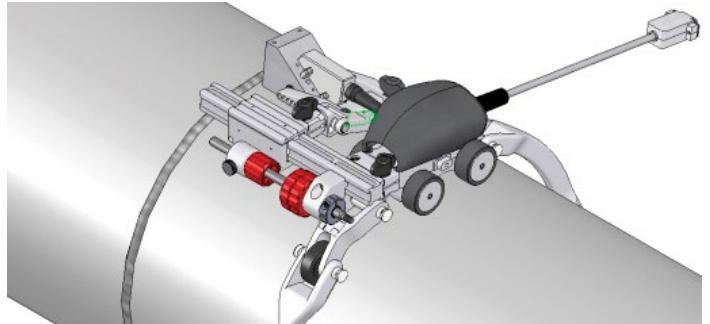

Ordering information

Part Number	Item Number	Description
ChainScan-XY38	U8750041	ChainSCANNER for 45 mm to 965 mm (1.75 in. to 38 in.) OD pipes with two encoded axes.
ChainScan-SP-Basic	U8779370	Basic spare part kit for the ChainSCANNER, which includes lead screw and lever for buckle, wedge pivot buttons, dovetail nuts, tool, plastic wheel, and screws.

MapSCANNER™ Solution for Corrosion Mapping

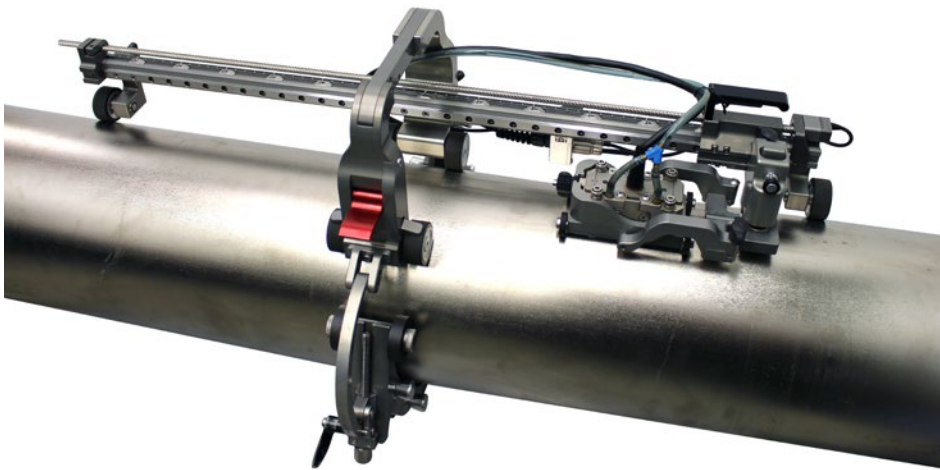

The innovative MapSCANNER manual scanner is designed for corrosion mapping inspections. With its wide scanning capability and quick indexing system, the MapSCANNER solution is the ideal scanner for high-production, phased array, semiautomated corrosion mapping inspections. It can be purchased with chain links or as an upgrade for the ChainSCANNER solution thanks to its compatibility with the chain links you may already own. The scanner can also be configured with magnetic wheels to inspect ferromagnetic parts where chain links are not required. When combined with the HydroFORM™ scanner or Dual Linear Array™ (DLA) corrosion mapping solutions, the MapSCANNER solution is a powerful tool to efficiently perform C-scan imaging of remaining wall thickness and mid-wall anomalies.

Ordering Information

Part number	Item Number	Description
MapSCANNER-ADPCHAIN	Q7500004	Manual scanner package upgrade from ChainSCANNER (without chain links and encoder cable)
MapSCANNER-LINKS	Q7500005	Complete manual scanner package including chain links
MapSCANNER-MAG	Q7500006	Complete manual scanner package with magnetic wheels
HydroFORM-K-SAUT	Q7500007	HydroFORM™ water box with 7.5 m long cable PA probe
MapSCANNER-A-MAG	Q7750071	Conversion kit to convert a MapSCANNER compatible with chain links to a magnetic version
MapSCANNER-SP-Basic	Q7750090	Basic spare part kit
MapSCANNER-A-Link	Q7750146	Kit of links to transform a MapSCANNER-MAG into a MapSCANNER-LINK

Features

- › Two-axis encoded scan.
- › Quick indexing system with adjustable keys.
- › Pass-through frame arch principle for greater scanning width.
- › Stabilizer wheels at both ends of the frame bar.
- › Brake system.
- › Optional chain links mounted on bearing wheels coated with urethane for smooth rolling.
- › A pipe range with outside diameters from 4 in. to 38 in. (102 mm to 965 mm) for the model using chain links.
- › A pipe range with outside diameters from 4 in. to flat (102 mm to flat) for the model using magnetic wheels.
- › Spring-loaded probe holders that ensure good probe contact in any scanner position or orientation.

Standard Inclusions

- › Adjustable spring-loaded probe holder.
- › HydroFORM water box-specific cart with wheels.
- › 7.5 m encoder cable for OmniScan™ flaw detectors with a zipper type cable protection sleeve (not included in MapSCANNER-ADPCHAIN).
- › Frame bar good for 580 mm wide inspection.
- › A carrying case.

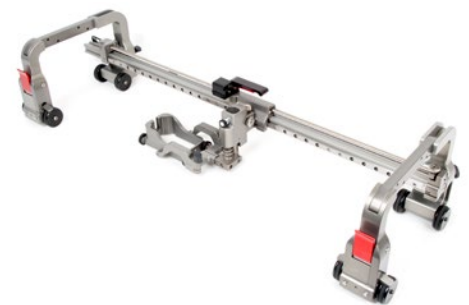

A version of the MapSCANNER solution is available for use on ferromagnetic surfaces of 4 in. OD to flat.

GLIDER™ Scanner for Composite Inspection



The GLIDER™ X-Y, two-axis encoding scanner is used for manual inspection of slightly curved or flat composite surfaces.

Commonly inspected materials include composites and aluminum using suction-cup pods and carbon steel using optional magnetic pods.

Applications

- › Inspection of composites.
- › Inspection of airplane fuselages for delamination and cracking.
- › Inspection of ferromagnetic plates for corrosion.
- › Inspection of friction stir welds (FSW) on aluminum.

Options

Magnetic accessories package

Magnetic mounting pods and Y-axis support enable use on ferromagnetic surfaces.

P/N: GLIDER-A-01 [U8775058]

Yokes

See the accessories section on page 35.

Couplant-Feed Units

See the accessories section on page 34.



Interchangeable mounting pods (magnetic pods are optional).

Features

- › Well-suited to phased array, conventional UT, and eddy current inspection techniques using one probe.
- › Two axes with waterproof encoders for position-encoded X-Y scans.
- › Axis positioning with minimal backlash.
- › Both modules are mounted on bearings for precise and smooth displacement.
- › Two pivot-equipped mounting pods enable surface following.
- › Locking devices for each axis.
- › Module displacement can be in increments of 3.27 mm, or in free-running mode.
- › The probe holder is mounted on a bearing-arm system that can be spring loaded if needed.
- › An aluminum frame is used for lightweight and rust-free components.
- › The Y axis can be easily shortened for smaller surface radius inspection or removed for easier transport.

Standard Inclusions

- › Two tracks (18 in., 24 in., or 36 in., depending on the model).
- › Two displacement-encoding modules.
- › Two suction-cup mounting pods.
- › Two encoders with a 5 m cable.
- › One PA 40 mm × 55 mm yoke.
- › One TOFD-P/E 31.75 mm yoke.
- › 90° probe holder mounting bracket.
- › 180° probe holder mounting bracket.
- › 45°, 90°, 180° adjustable probe holder mounting bracket.
- › Probe holder bearing arm with spring.
- › Irrigation tubing and fitting.
- › A carrying case.

Note: the umbilical cable, probes, and wedges are not included with the scanner.

Specifications

Weight: 5 kg to 8 kg, depending on the configuration

Suction-cup pod holding force: 18 kg

Magnetic-pod holding force: 81 kg per base

Encoder resolution: 13 steps/mm (±0.15 step/mm), 330 steps/in. (±0.006 step/in.)

Minimum curvature for partial scans: 50 cm (20 in.) OD

Ordering Information

Part Number	Item Number	Description	Length (X) (mm)	Width (Y) (mm)	Height (mm)
GLIDER-18X18	U8750001	GLIDER scanner with X-Y 457 mm × 457 mm stroke	700	690	152
GLIDER-24X24	U8750002	GLIDER scanner with X-Y 610 mm × 610 mm stroke	900	845	152
GLIDER-36X36	U8750003	GLIDER scanner with X-Y 914 mm × 914 mm stroke	1200	1150	152

Pulsers and Preamplifiers

TRPP 5810™ Pulser/Preamplifier for TOFD Inspection

The TRPP 5810™ unit is a high-performance remote pulser/preamplifier dedicated to TOFD inspections and compatible with Olympus scanners. This remote pulser/preamplifier provides an optimum signal-to-noise ratio for TOFD inspections by combining a 40 dB preamplifier with a remote high-voltage (200 V) pulse repeater in a single, small enclosure. The TRPP 5810 unit supports two UT channels, enabling simultaneous inspection with one or two pairs of TOFD probes. The TRPP 5810 unit can be used as a pulser and/or preamplifier.

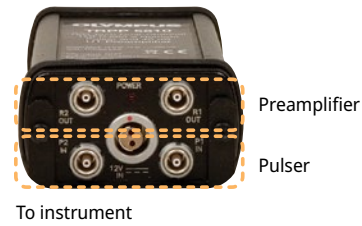
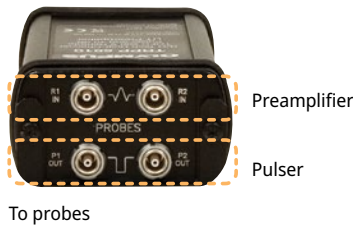

TRPP 5810 Unit as a Pulser

- › Provides an additional pulse gain to generate a stronger signal, as needed, to reveal difficult-to-detect flaws.

TRPP 5810 Unit as a Preamplifier

- › Provides the additional gain or broadband signal-to-noise enhancement necessary for optimum signal acquisition on thick sections of material.
- › Enables long cables to be driven from remotely located sensors.

Ordering Information

Part Number	Item Number	Package Contents
TRPP-5810	U8120042	Pulser/preamplifier, one 5 m power supply cable (120 VAC to 240 VAC input to 12 VDC output), one 5 m power supply cable linking to an OmniScan™ MX or MX2 flaw detector.
TRPP-5810-KIT01	U8120043	Same as P/N TRPP-5810, plus: Four 0.6 m UT probe cables (LEMO® 00 to Microdot™), and brackets. (P/N: HSMT-A-BRK5810 [U8779088])
TRPP-5810-INST	U8775114	Same as P/N TRPP-5810-KIT01, plus: Four 5 m UT cables (LEMO 00 to LEMO 00) linking the TRPP 5810 unit to the instrument.
TRPP-5810-UMB	U8775113	Same as P/N TRPP-5810-KIT01, plus: Four 0.6 m UT cables (LEMO 00 to LEMO 00) linking the TRPP 5810 unit to the umbilical.

5682 Preamplifier for TOFD Inspection

The 5682 ultrasonic preamplifier provides low-noise amplification of ultrasonic signals (for one probe) ranging from 500 kHz to 25 MHz. The preamplifier, which is housed in a rugged splashproof enclosure, is very small and lightweight, making it ideally suited to remote applications. The preamplifier can be powered with either a single 9 V battery (included) for up to 50 hours of continuous operation or an optional 9 V to 13 V DC supply. When battery operated, a multicolored LED provides battery feedback status. This preamplifier is ideal for TOFD inspections.

Specifications

- › 26 dB gain
- › 50 hours of battery life (continuous discharge)
- › 67 dB signal-to-noise ratio



Ordering Information

Part Number	Item Number	Package Contents
5682	U8120006	5682 preamplifier and 9 V battery
5682-KIT01	U8120038	5682 preamplifier, one 2.5 m UT probe cable (LEMO® 00 to LEMO 00), one 2.5 m power supply cable linking to an OmniScan™ MX or MX2 flaw detector, and a belt case.
5682-KIT02	U8779091	5682 preamplifier, one 5 m UT probe cable (LEMO 00 to LEMO 00), one 5 m UT probe cable (LEMO 00 to Microdot), one 0.6 m UT probe cable (LEMO 00 to Microdot™), one 5 m power supply cable linking to an OmniScan™ MX or MX2 flaw detector, a belt case, and a bracket to attach a scanner (P/N: HSMT-A-BRK5682 [U8779089]).

Cables and Adaptors

Umbilical Cables

Umbilical cables are used to make all the connections between the scanner and the acquisition unit. They can be of two types:

- > Closed umbilical
- > Divisible conduit

Closed umbilical

The closed-type umbilical offers the best rugged protection. It covers the cable with a resistant, waterproof, and dust proof conduit. It is also fitted with a safety hook on both ends and comes in different models according to the applications and scanners with that it is intended to be used with. The configuration of the cables is fixed and cannot be changed afterwards.



Ordering information for Umbilical cables

Umbilical cable type	UT and PA cables	Cable length	Power cable
UMB	UTPA0202	10	RO
UMB1 Umbilical for HSMT scanners.	UT RG174 coaxial cables for conventional UT probes. PA0000 128-element OmniScan™ PA probe extension. PA0202 124-element OmniScan PA probe extension with 4 LEMO® 00 at pin 63–64 and 127–128. IBTx 128-element Interbox with two OmniScan PA probe connectors, TRPP 5810™ unit, and x (0, 4, or 8) extra UT channels. IBx 128-element Interbox with two OmniScan PA probe connectors and x (0, 4, or 8) UT channels. 64IBTx 64-element Interbox with two OmniScan PA probe connectors, TRPP 5810™ unit, and x (0, 4, or 8) extra UT channels. 64IBx 64-element Interbox with two OmniScan PA probe connectors, and x (0, 4, or 8) UT channels.	5 5 m 10 10 m	RO Remote pulser/receiver or Interbox power cable linking to an OmniScan® or AC-using adaptor.

*Can be customized, common values shown. Note that, under certain circumstances, the use of longer phased array cables can lead to signal degradation due to attenuation and/or crosstalk.



Divisible conduit

The divisible type is composed of two split shells that completely protect the cables. Even though it is not as rugged as the closed-type umbilical, it offers other advantages. Because the cables can be changed inside at any time, there is no need for connection boxes, which are often needed for PA probes on the scanners. The probes must have the proper cable length to reach the acquisition unit.

Ordering information

Part Number	Item Number	Description
60BA5028	U8779093	One 0.3 m divisible cable conduit with a 16 mm ID. Well-suited to 2 × PA, irrigation tube, and the encoder cable.
60BA0109	U8779094	One 0.3 m divisible cable conduit with a 19.2 mm ID. Well-suited to 2 × PA, 2 × conventional UT, irrigation tube, and the encoder cable. Standard equipment on the HydroFORM™ scanner.
60BA0131	U8775093	One 0.3 m divisible cable conduit with a 24.2 mm ID. Well-suited to 2 × PA, 4 × conventional UT, irrigation tube, encoder, and preamplifier power supply cables.
OPTX0719	U8779095	One 5 m divisible cable conduit with 24.2 mm ID. Well-suited to 2 × PA, 4 × conventional UT, irrigation tube, encoder, and preamplifier power supply cables. Standard equipment on the WeldROVER™ scanner.

Adaptors and Extension Cables

Part Number	Item Number		Description
Adaptors			
OMNI-A2-ADP03	U8775202		Adaptor for Hypertronics® PA probe to instrument with an OmniScan™ connector. Compatible with OmniScan PA instruments.
OMNI-A-ADP05*	U8767016		Y adaptor with OmniScan connectors to support two PA probes with a maximum of 64 elements each. Compatible with OmniScan MX instruments. Connector layout: one female output and two male inputs.
OMNI-A2-SPLIT64	U8100135		Y-adaptor (splitter) with OmniScan connectors to support 2 phased array probes. Compatible with the OmniScan MX2 with PA2 module and OmniScan X3 unit using mounting plate P/N: U8150431 (included). Part number details SPLIT64: Compatible with 64 element PA2 modules SPLIT128: Compatible with 128 element PA2 modules 4UT: Features four LEMO® 00 UT connectors
OMNI-A2-SPLIT64-4UT	U8100136		
OMNI-A2-SPLIT128	U8100133		
OMNI-A2-SPLIT128-4UT	U8100134		
OMNI-A-ADP11*	U8767019		Adaptor with LEMO 00 connectors. Enables the use of up to 8 conventional UT probes with an OmniScan MX PA instrument.
OMNI-A-ADP12	U8767020		Adaptor with LEMO 00 connectors. Enables the use of up to 16 conventional UT probes with an OmniScan PA instrument. Supplied with a 1 m cable.
*These adaptors cannot be connected directly to the OmniScan MX2 instrument. To make the connection, a PA extension cable is needed (E128P type, shown on table below).			
Phased Array Extension cables (Common models)			
E128P0-0202-OM	U8800635		An extension cable with an OmniScan connector at both ends. Can be fitted with 4 LEMO 00 connectors enabling the simultaneous use of conventional UT and PA probes with a PA instrument. Option: A bracket for mounting the OmniScan PA extension on HSMT scanners. P/N: HSMT-A-BRKEK [U8779090]
E128P5-0004-OM	U8800441		
E128P5-0202-OM	U8800442		
E128P10-0004-OM	U8800431		
E128P10-0202-OM	U8800432		
Combining extension cables with adaptors offers numerous connection possibilities.			

Ordering information for PA Extension Cables

Number of elements in extension	Cable type	Cable length*	Connector on the probe side*	Connector on the instrument side*
E128	P	10	0202	OM
128 128 elements	P Flexible PVC cable M Metal armor outer cover	0 0.5 m 5 5 m 10 10 m	0000 OmniScan connector and 0 LEMO 0004 OmniScan connector and 4 LEMO at pins 125–128 0202 OmniScan connector and 4 LEMO at pins 63–64 and 127–128 HY Hypertronics connector	OM OmniScan connector HY Hypertronics connector * can be customized, common values shown.

Note: Under certain circumstances, the use of longer phased array cables can lead to signal degradation due to attenuation and/or crosstalk.

InterBox



The InterBox interconnection box is an ergonomic solution for a common problem associated with scanner accessories and connection buildup. This compact hub can connect two phased array probes and two amplified TOFD channels in addition to eight conventional UT channels driven by a phased array acquisition unit. The InterBox unit can integrate a PA splitter, a TRPP 5810™ TOFD pulser/preamplifier, and up to eight extra conventional UT connections, depending on the configuration.

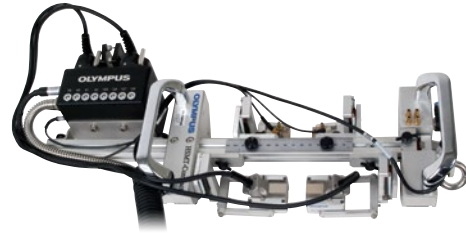

Ordering information

Extension type	TRPP 5810	Conventional UT connectors (LEMO® 00)	Cable type	Cable length in meters	Instrument connector
EIB	T	8	M	5	OM
IB InterBox of 128 elements (can connect two PA probes of maximum 64 elements each) IB64* InterBox of 64 elements (can connect two PA probes of maximum 32 elements each) * Required for OmniScan® PA instruments with 64 elements.	T TRPP 5810 included NT TRPP 5810 not included	0 Zero connectors 4 Four connectors 8 Eight connectors	P Flexible PVC cable M Metal armor outer cover		OM OmniScan® connector HY Hypertronics® connector

Under certain circumstances, the use of longer phased array cables can lead to signal degradation due to attenuation and/or crosstalk.

Indexer Clicker



Clicker-scanner
5 m long cable, laser guide, and a scanner mounting bracket compatible with HSMT scanners

P/N: Q7500012

Using an indexer clicker is an economical way to create a C-scan with a one-axis scanner. The indexer clicker is offered in two different models optimized for either manual or semi-automated inspection.

Both models feature:

- Ergonomic handle
- LEMO 16-pin encoder input
- Indexing button
- Configurable digital input (DIN) button
- Encoder cable with LEMO 16-pin connector compatible with current OmniScan instruments



Clicker-manual
2.5 m cable for manual operation

P/N: Q7500011

Couplant Feed Units

CFU03 and CFU05 Electric Couplant Feed Units



CFU05

CFU03

The CFU03 and CFU05 portable electric-pump units are used to supply couplant to wedges during ultrasonic inspections. Both units are equipped with a diaphragm pump equipped with a bypass to ensure a constant flow and avoid any pump priming issues. The pump units are also equipped with a valve to control the outlet flow. The CFU05 unit features water-suction capabilities to reduce water loss when used with certain water delay line wedges.

CFU03 Features

- › A diaphragm pump with a flow of 3.78 l/min (1 GPM) at 60 psi.
- › An internal bypass that ensures the pump is always primed.
- › Operates on 100 VAC and 240 VAC.
- › Start/Stop button.
- › An outlet flow control valve.
- › A pump inlet tube equipped with a filter and check valve to ensure that the tube is always filled.
- › Inlet and outlet quick-connect fittings.
- › A rugged plastic case.
- › CE certified.

CFU05 Features

The CFU05 unit has the same features as the CFU03, plus:

- › Water suction generated by a Venturi system using an external compressed-air supply.

Standard Inclusions

- › 3.3 m (10 ft), 9.5 mm (3/8 in.) ID tube for pump inlet with filter and check valve.
- › 3.3 m (10 ft), 9.5 mm (3/8 in.) ID tube for vacuum outlet (CFU05 only).
- › 3.3 m (10 ft), 5 mm (3/16 in.) ID tube and Y adaptor for pump outlet.
- › 3.3 m (10 ft), 5 mm (3/16 in.) ID tube and Y adaptor for vacuum inlet (CFU05 only).
- › Power supply, 100 VAC to 240 VAC input to 24 VDC output.



WTR-SPRAYER-8L

Manual Couplant Feed Units

The manual-pump unit offers an affordable and efficient way to supply couplant to wedges during automated inspections.

Features

- › Reservoir capacity of 4 L or 8 L
- › Flow valve
- › Supplied tubes: 8 mm OD and 5 mm ID
- › Sling for easy transport

Ordering Information

Part Number	Item Number	Description
CFU03	U8780008	Electric couplant feed unit
CFU05	U8780009	Electric couplant feed unit with suction capability
WTR-SPRAYER-4L	U8775153	4 L manual water pump with irrigation tubes and fittings
WTR-SPRAYER-8L	U8775001	8 L manual water pump with irrigation tubes and fittings

Yokes

Yokes are used to attach the wedges to the spring-loaded arms (SLA) used on most scanners. Depending on the wedge model used, the yoke model changes. The yokes below are compatible with HSMT-Compact™, WeldROVER™, and GLIDER™ scanners, as well as previous generation HSMT-Flex™ scanners.

Ordering Information

Part Number	Item Number	Wedge compliance	Button OD (mm)	A (mm)	B (mm)
Standard Yokes					
ADIX689	U8775048	ST1, ST2, SPE1, SPE2, SPE3, and SA0	5	31.75	23.5
ADIX655	U8775047	SA1, SA2, SA10, SA11, SA12, SA31, SA32, SI1, SPWZ3, SNW1-AQ25 (WR), and SNW3-AQ25	8	40	55
ADIX612	U8775046	SA10, SA11, SA31, and SA32	8	40	38
Other Yokes					
ADIX1354	U8775187	SPWZ1 and SA14 (in reverse position)	8	40	46
ADIX1082	U8780194	SPWZ1, SA14, RexoFORM, and SNW3-AQ25-WR	8	40	65
PH1-Yoke-55x45-5mm	Q7750200	SA28	5	45	55
ADIX853	U8775055	SA1-L (lateral)	8	45	60
ADIX846	U8779096	SA3 and SA26	8	50	55
ADIX893	U8775084	SA4, SA5, and HydroFORM-A-LiteHolder	8	55	55
ADIX908	U8779097	Water wedge	8	50	65
PH1-PA-FORK-65x64-5deg	Q7750157	SI5	8	64	65
ADIX1325	U8775132	SNW1	8	31.75	55
ADIX1482	U8775165	SNW2	8	31.75	23.5
ADIX1481	U8775164	SNW3	8	31.75	65
ADIX1896	Q7750014	SA17-DN	5	50	38
ADIX1897	Q7750015	SA17-N	5	31.75	38
ADIX870	U8775056	SA27-DN and creeping wave probe holder (ADIX1129) [U8775080]	5	40	23

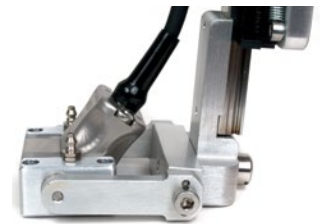
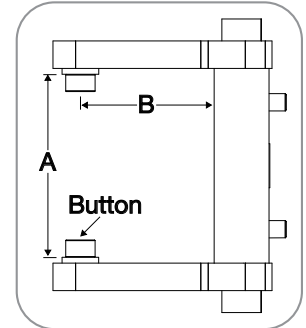

Aqualene Elastomer Couplant

Aqualene™ is an elastomer designed for ultrasonic inspection applications. Acoustic impedance of the material is nearly the same as water, and its attenuation coefficient is lower than many documented elastomers and plastics. Applications for nondestructive testing include:

- › Flexible couplant pads with minimal water addition.
- › Low-velocity delay lines.
- › Water-box membrane.

Aqualene elastomer couplant reduces the drawbacks of wet coupling when used on porous or refractory surfaces. It allows a minimal amount of couplant to be used while protecting the probe when in direct contact with the part. Furthermore, Aqualene can serve as a thermic insulator. Aqualene couplant products are available in many sizes and thicknesses.

Ordering Information

Part Number	Item Number	Description	Size (L x W x H) mm (in.)
29HD0002	U8770300	Plate	146 × 146 × 2 (5.75 × 5.75 × 0.08)
29HD0004	U8770301	Plate	152 × 152 × 6.4 (6 × 6 × 0.25)
29HD0005	U8770302	Plate	102 × 102 × 25.4 (4 × 4 × 1)
29HD0009	U8770299	Plate	102 × 203 × 2.3 (4 × 8 × 0.09)
29HD0010	U8770303	Plate	200 × 100 × 0.5 (7.9 × 3.9 × 0.02)
29HD0011	U8770304	Plate	127 × 127 × 25.4 (5 × 5 × 1)



How to Order

For pricing or additional information, contact your local sales representative.

To quickly locate your local sales representative, go to www.olympus-ims.com.

Training

Evident works with major training companies to develop our Training Academy to offer comprehensive courses in phased array technology and applications. Courses range from a two-day "Introduction to Phased Array" program to an in-depth, two-week "Level II Phased Array" course. In both cases, students experience practical training utilizing the portable OmniScan™ phased array flaw detector. Courses lead to either recognized certification or certificates of attendance.

Courses are currently being offered at the training facilities of participating companies and at customer-determined locations worldwide. Customized courses can also be arranged. Check the latest course schedule in the "Support" section at www.olympus-ims.com.

About Evident

Evident is known for its pioneering work in optical technology, electronics, and precision manufacturing. A leader in providing solutions for customers in the industrial and life science markets, Evident offers a comprehensive portfolio of advanced technologies including remote visual, microscopy, ultrasound, eddy current, eddy current array, and X-ray fluorescence.

Our commitment to designing quality products is directly linked to our customers' responsibility to help ensure safety, quality, and reliability by complying with the highest industry standards and regulations to help people lead safe and productive lives.



Evident Scientific, Inc.
48 Woerd Avenue
Waltham, MA 02453, USA
(1) 781-419-3900

Evident Canada Inc.
3415 Rue Pierre-Ardouin,
Québec, QC G1P 0B3, Canada
+1-418-872-1155

EVIDENT CORPORATION is certified to ISO 9001, ISO 14001, and OHSAS 18001.

*All specifications are subject to change without notice.

All brands are trademarks or registered trademarks of their respective owners and third party entities. VersaMOUSE, Mini-Wheel, COBRA, HSMT-Compact, HSMT-Flex, RollerFORM, HydroFORM, RexoFORM, FlexoFORM, WeldROVER, MapROVER, SteerROVER, ChainSCANNER, MapSCANNER, GLIDER, TRPP 5810, AxSEAM, ScanDeck, and Dual Linear Array are trademarks of Evident Corporation or its subsidiaries. LEMO is a registered trademark of LEMO SA. Microdot is a trademark of Tyco Electronics Corporation. Revolite is a registered trademark of C-Let Plastics Inc. Hypertronics is a registered trademark of Hypertronics Corporation. Copyright © 2024 by Evident Corporation.

